

SIZE A	DWG NO 37G00201	SHT 1	REV
REV	DESCRIPTION	DATE	APPROVED

3 Phase Line/Load Reactor

OPEN FRAME

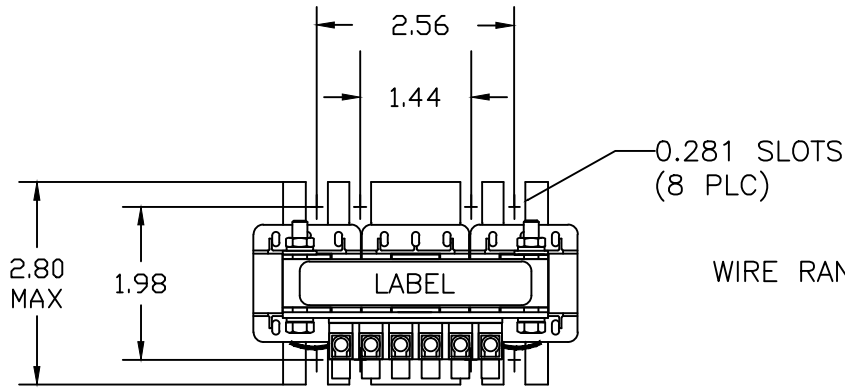

WIRE RANGE: 22-10 AWG

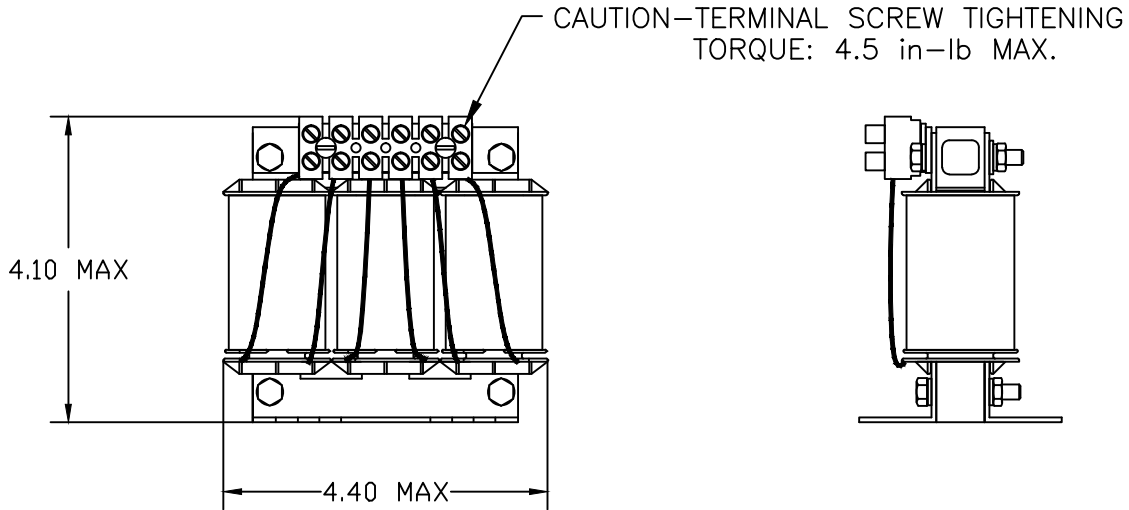

INDUCTANCE	WATTS LOSS	FUND. AMPS	MAX. AMPS	WEIGHT (LBS)
12.0 mH	7.5	2.0	3.0	4



GE GRID SOLUTIONS
CLEARWATER, FL

SIZE

A

LV LINE REACTOR
37G00201

DRAWN DCS DATE 1/11/2017

ISSUED DATE 1/11/2017

SCALE

SHEET 1 CONT ON -