

SIZE A	DWG NO 37G00204	SHT 1	REV
REV	DESCRIPTION	DATE	APPROVED

3 Phase Line/Load Reactor

OPEN FRAME

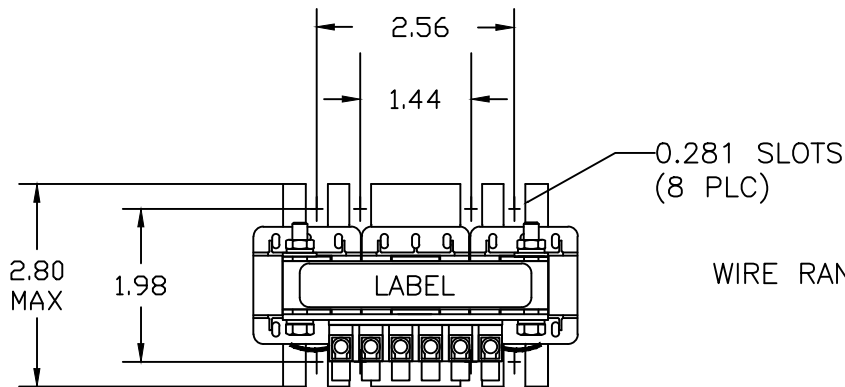

WIRE RANGE: 22-10 AWG

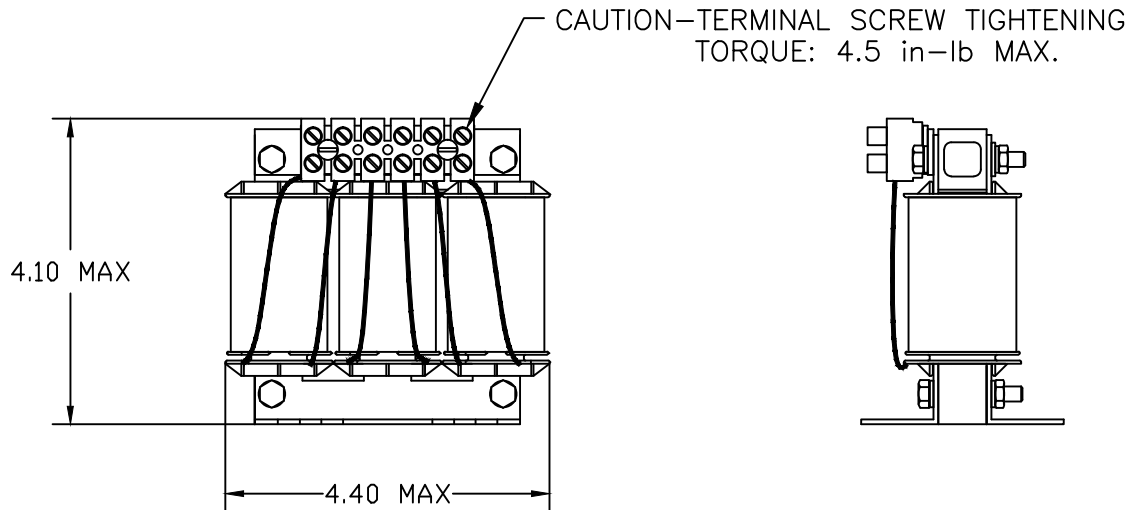

INDUCTANCE	WATTS LOSS	FUND. AMPS	MAX. AMPS	WEIGHT (LBS)
6.0 mH	10.7	2.0	3.0	3



GE GRID SOLUTIONS
CLEARWATER, FL

SIZE

A

LV LINE REACTOR
37G00204

DRAWN DCS DATE 1/11/2017

ISSUED DATE 1/11/2017

SCALE

SHEET 1 CONT ON -