

SIZE A	DWG NO 37G00412	SHT 1	REV
REV	DESCRIPTION	DATE	APPROVED

3 Phase Line/Load Reactor

NEMA 1 ENCLOSURE

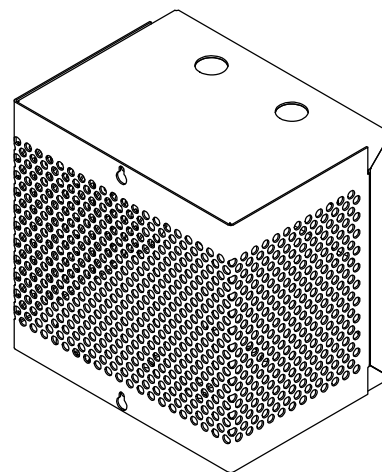
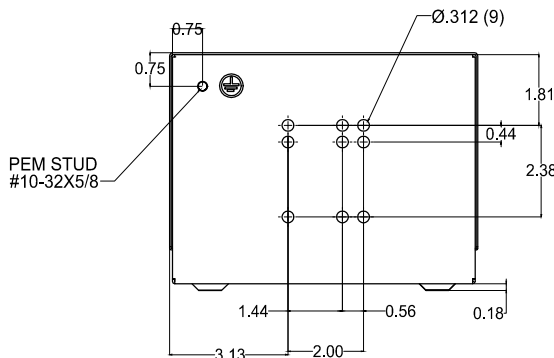
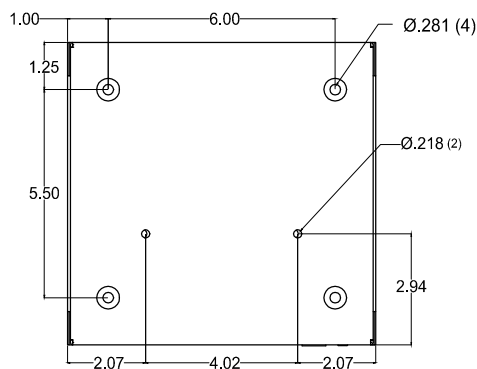
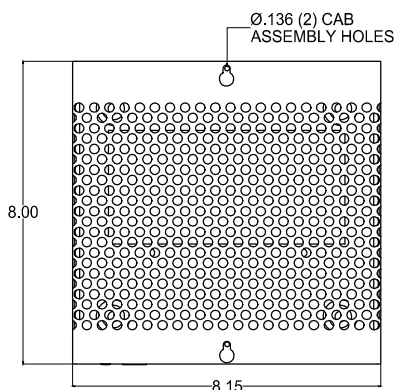
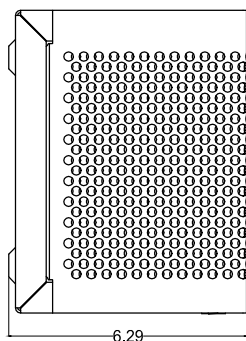
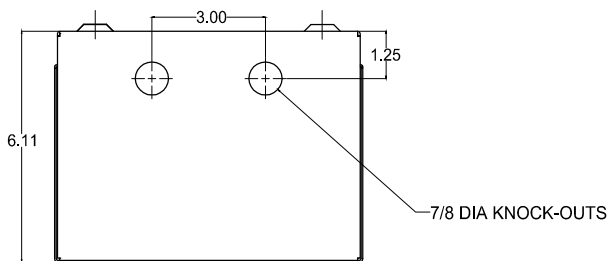

- HARDWARE INCLUDED:**
- NUT 1/4-20 HEX STEEL ZINC PLATED QTY 1
 - NUT 1/4-20 HEX STEEL ZINC PLATED QTY 4
 - SCREW 1/4-20X3/4 HEX STEEL ZINC PLATED QTY 4
 - WASHER 1/4 FLAT STEEL ZINC PLATED QTY 8
 - WASHER 1/4 SPLITLOCK STEEL ZINC PLATED QTY 4
 - WASHER #10 FLAT STEEL ZINC PLATED QTY 3
 - WASHER #10 SPLITLOCK STEEL ZINC PLATED QTY 3
 - NUT #10-32 HEX STEEL ZINC PLATED QTY 3
 - SCREW #10-32X3/4 RH STEEL ZINC PLATED QTY 2
 - SCREW #8-32X3/4 RH SLFT STL ZINC PLATED QTY 2

ALL DIMENSIONS IN INCHES UNLESS OTHERWISE NOTED

INDUCTANCE	WATTS LOSS	FUND. AMPS	MAX. AMPS	WEIGHT (LBS)
6.5 mH	20.0	4.0	6.0	11.0



GE GRID SOLUTIONS
CLEARWATER, FL

SIZE

A

LV LINE REACTOR
37G00412

DRAWN DCS DATE 1/11/2017

ISSUED DATE 1/11/2017

SCALE

SHEET 1 CONT ON -