

SIZE A	DWG NO 37G01202	SHT 1	REV
REV	DESCRIPTION	DATE	APPROVED

3 Phase Line/Load Reactor
OPEN FRAME

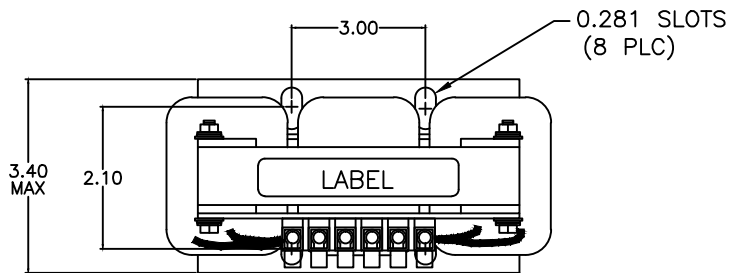

WIRE RANGE: 14-6 AWG

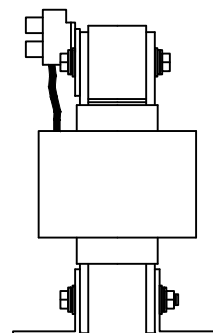
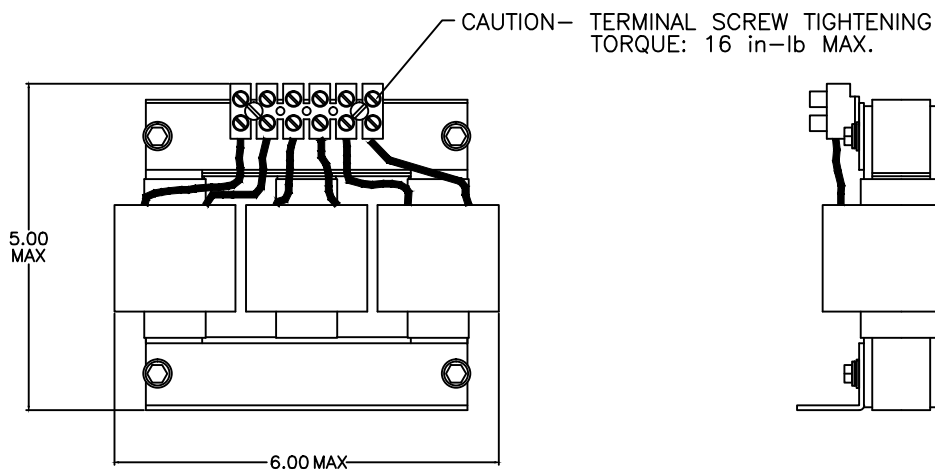

** ALSO AVAILABLE IN NEMA 1 ENCLOSURE

INDUCTANCE	WATTS LOSS	FUND. AMPS	MAX. AMPS	WEIGHT (LBS)
2.5 mH	31.0	12.0	18.0	10



GE GRID SOLUTIONS
CLEARWATER, FL

SIZE

A

LV LINE REACTOR
37G01202

DRAWN DCS DATE 1/12/2017

ISSUED DATE 1/12/2017

SCALE

SHEET 1 CONT ON -