

SIZE A	DWG NO 37G01813	SHT 1	REV
REV	DESCRIPTION	DATE	APPROVED

3 Phase Line/Load Reactor
NEMA 1 ENCLOSURE

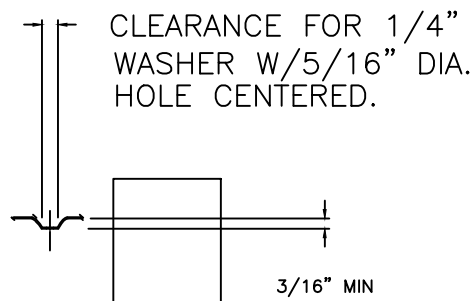

INDUCTANCE	WATTS LOSS	FUND. AMPS	MAX. AMPS	WEIGHT (LBS)
2.5 mH	43.0	18.0	27.0	34.0

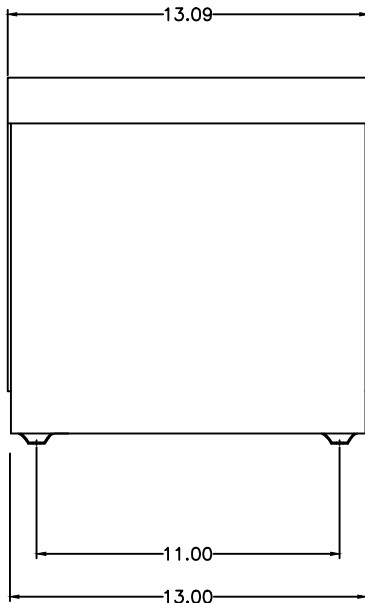
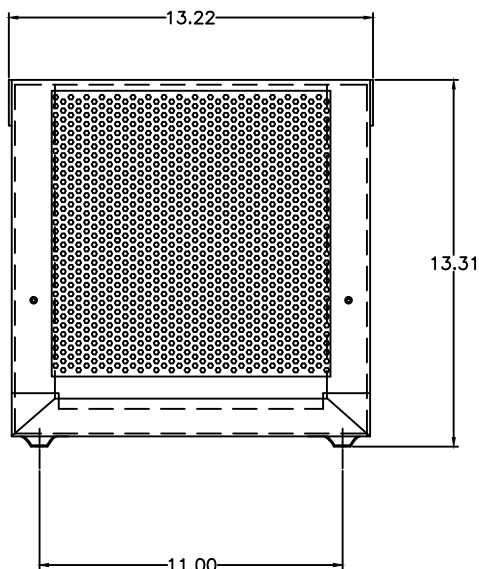

GE GRID SOLUTIONS
CLEARWATER, FL

SIZE

A

LV LINE REACTOR
37G01813

DRAWN DCS DATE 1/16/2017

ISSUED DATE 1/16/2017

SCALE

SHEET 1 CONT ON -