

SIZE A	DWG NO 37G02512	SHT 1	REV
REV	DESCRIPTION	DATE	APPROVED

3 Phase Line/Load Reactor
NEMA 1 ENCLOSURE

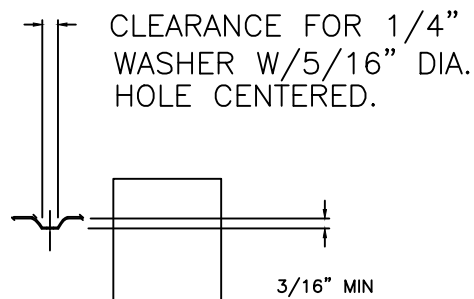

INDUCTANCE	WATTS LOSS	FUND. AMPS	MAX. AMPS	WEIGHT (LBS)
1.2 mH	52.0	25.0	37.5	32.0

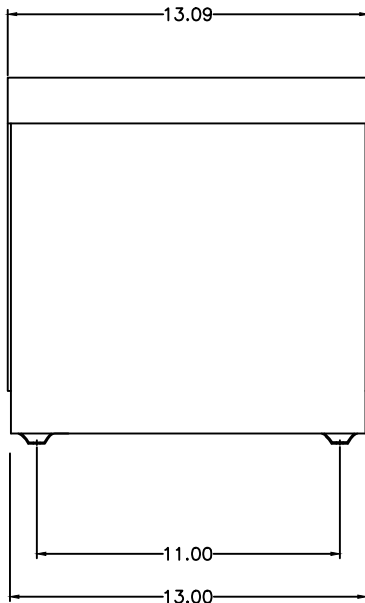
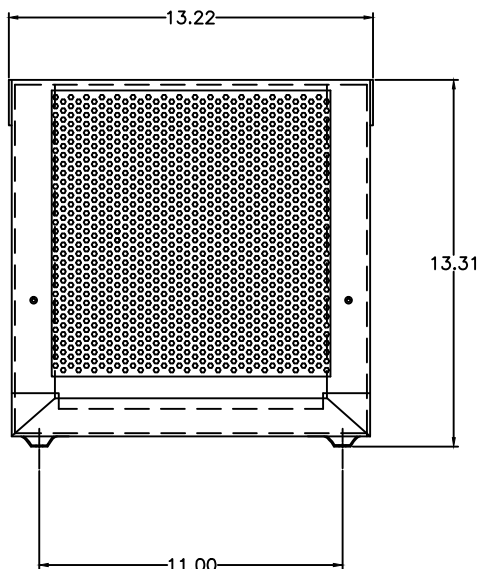

GE GRID SOLUTIONS
CLEARWATER, FL

SIZE

A

LV LINE REACTOR
37G02512

DRAWN DCS DATE 1/16/2017

ISSUED DATE 1/16/2017

SCALE

SHEET 1 CONT ON -