

SIZE A	DWG NO 37G02513	SHT 1	REV
REV	DESCRIPTION	DATE	APPROVED

3 Phase Line/Load Reactor  
NEMA 1 ENCLOSURE

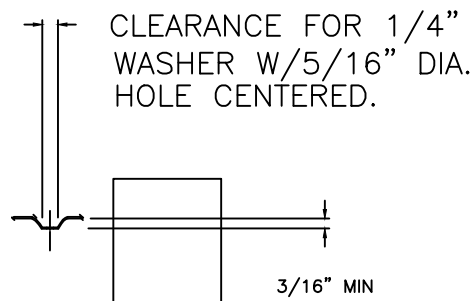

INDUCTANCE	WATTS LOSS	FUND. AMPS	MAX. AMPS	WEIGHT (LBS)
1.8 mH	61.0	25.0	37.5	38.0

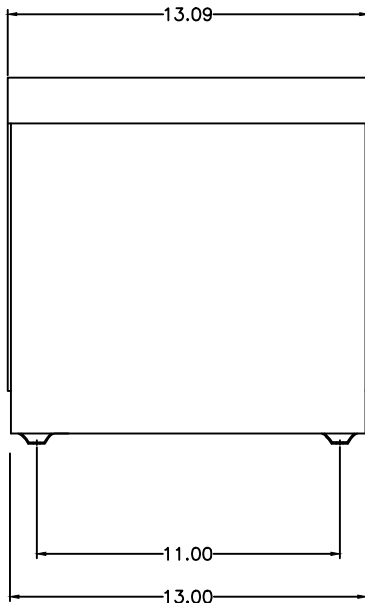
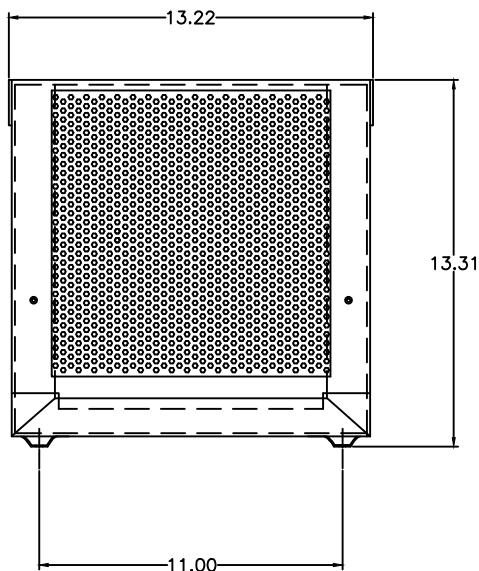

GE GRID SOLUTIONS  
CLEARWATER, FL

SIZE

A

LV LINE REACTOR  
37G02513

DRAWN DCS DATE 1/16/2017

ISSUED DATE 1/16/2017

SCALE

SHEET 1 CONT ON -