

SIZE A	DWG NO 37G03501	SHT 1	REV
REV	DESCRIPTION	DATE	APPROVED

3 Phase Line/Load Reactor
OPEN FRAME

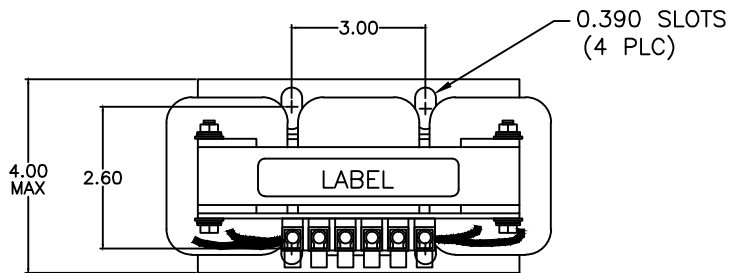

WIRE RANGE: 14-6 AWG

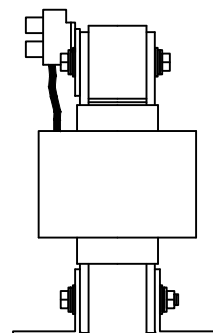
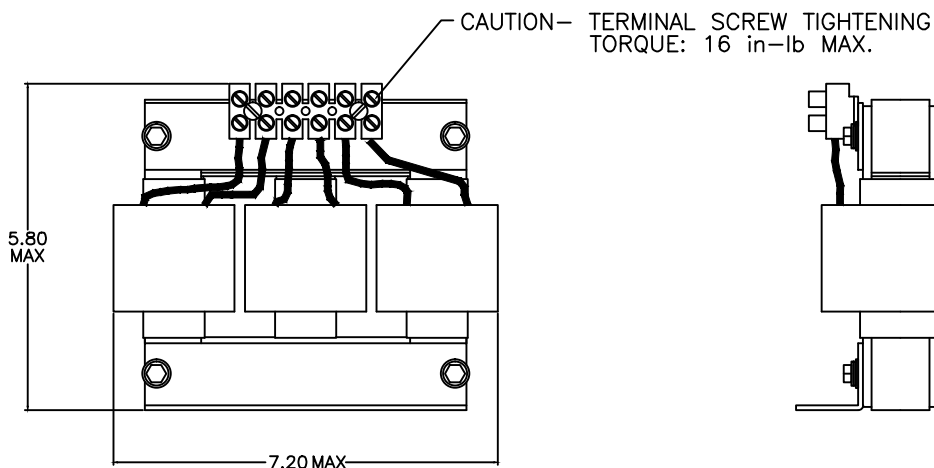

** ALSO AVAILABLE IN NEMA 1 ENCLOSURE

INDUCTANCE	WATTS LOSS	FUND. AMPS	MAX. AMPS	WEIGHT (LBS)
0.40 mH	49.0	35.0	52.5	14



GE GRID SOLUTIONS
CLEARWATER, FL

SIZE

A

LV LINE REACTOR
37G03501

DRAWN DCS DATE 1/16/2017

ISSUED DATE 1/16/2017

SCALE

SHEET 1 CONT ON -