

SIZE A	DWG NO 37G04503	SHT 1	REV
REV	DESCRIPTION	DATE	APPROVED

3 Phase Line/Load Reactor
OPEN FRAME

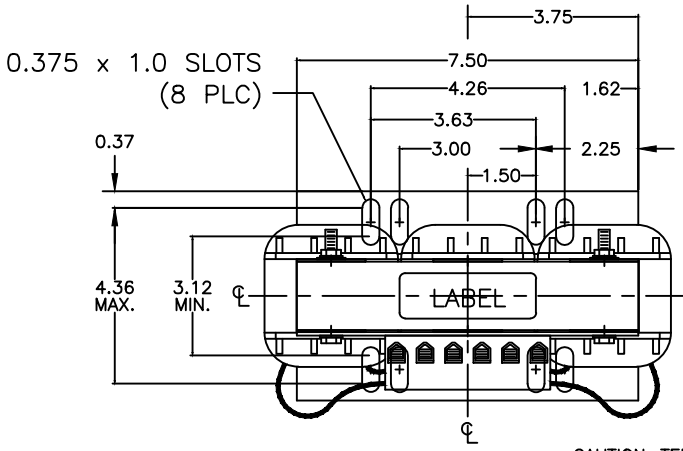

WIRE RANGE: 18-4 AWG

NOTE:
CENTER LINE REPRESENTS
CENTER OF REACTOR CORE

CAUTION-TERMINAL SCREW TIGHTENING
TORQUE: 16 in-lb MAX.

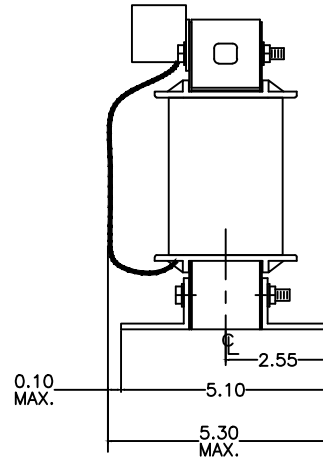
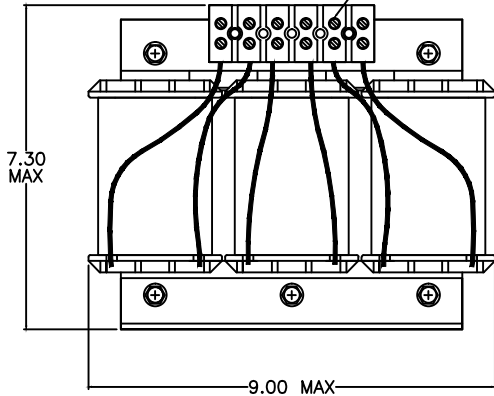

** ALSO AVAILABLE IN NEMA 1 ENCLOSURE

INDUCTANCE	WATTS LOSS	FUND. AMPS	MAX. AMPS	WEIGHT (LBS)
0.7 mH	62.0	45.0	67.5	28



GE GRID SOLUTIONS
CLEARWATER, FL

SIZE

A

LV LINE REACTOR
37G04503

DRAWN DCS DATE 1/16/2017

ISSUED DATE 1/16/2017

SCALE

SHEET 1 CONT ON -