

SIZE A	DWG NO 37G08013	SHT 1	REV
REV	DESCRIPTION	DATE	APPROVED

3 Phase Line/Load Reactor  
NEMA 1 ENCLOSURE

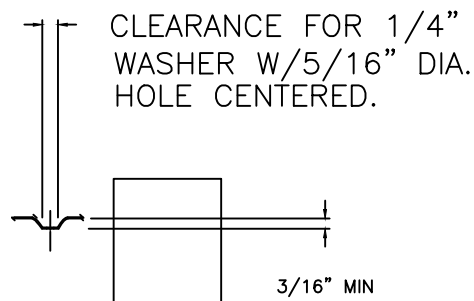

INDUCTANCE	WATTS LOSS	FUND. AMPS	MAX. AMPS	WEIGHT (LBS)
0.7 mH	96.0	80.0	120.0	79.0

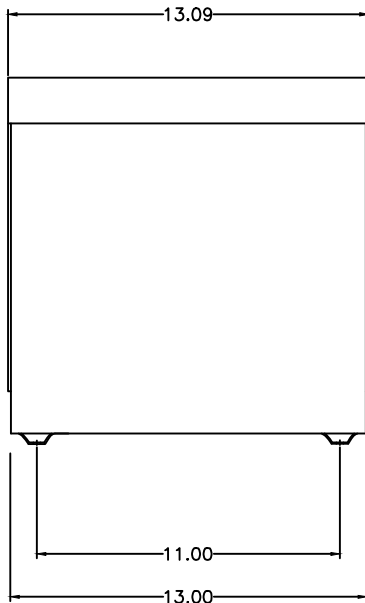
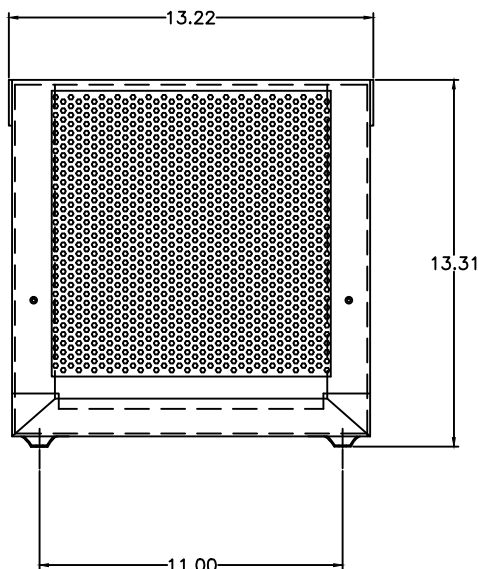

GE GRID SOLUTIONS  
CLEARWATER, FL

SIZE

A

LV LINE REACTOR  
37G08013

DRAWN DCS DATE 1/17/2017

ISSUED DATE 1/17/2017

SCALE

SHEET 1 CONT ON -