

SIZE A	DWG NO 37G10001	SHT 1	REV
REV	DESCRIPTION	DATE	APPROVED

3 Phase Line/Load Reactor
OPEN FRAME

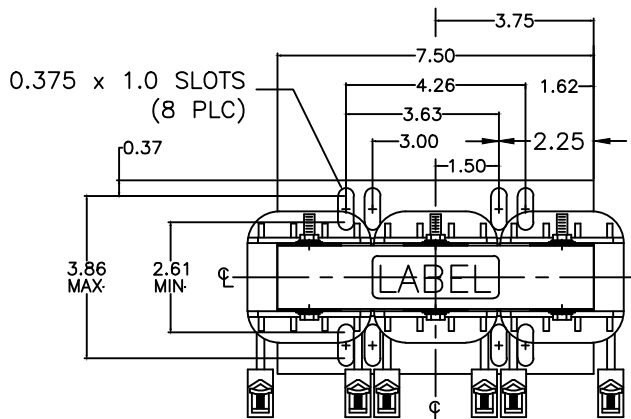

WIRE RANGE: 6-0 AWG

NOTE:
CENTER LINE REPRESENTS
CENTER OF REACTOR CORE

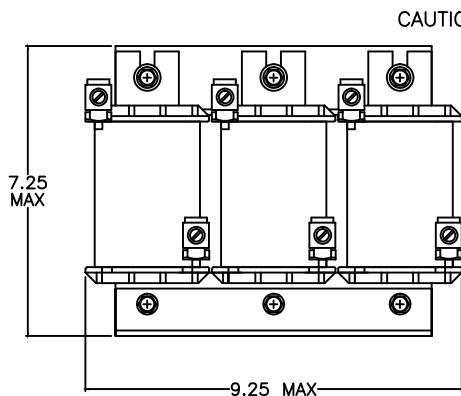

CAUTION-TERMINAL SCREW TIGHTENING
TORQUE: 6-4 (45) in-lb MAX.
2-0 (50) in-lb MAX.

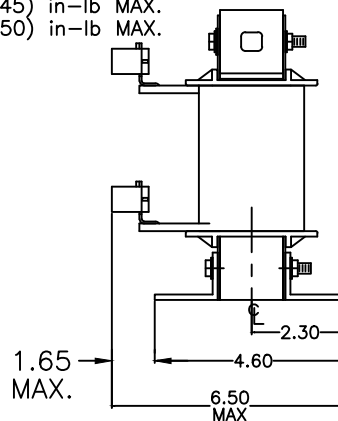

** ALSO AVAILABLE IN NEMA 1 ENCLOSURE

INDUCTANCE	WATTS LOSS	FUND. AMPS	MAX. AMPS	WEIGHT (LBS)
0.20 mH	94.0	100.0	150.0	29



GE GRID SOLUTIONS
CLEARWATER, FL

SIZE

A

LV LINE REACTOR
37G10001

DRAWN DCS DATE 1/18/2017

ISSUED DATE 1/18/2017

SCALE

SHEET 1 CONT ON -