

SIZE A	DWG NO 37G120003B14	SHT 1	REV
REV	DESCRIPTION	DATE	APPROVED

3 Phase Line/Load Reactor
OPEN FRAME

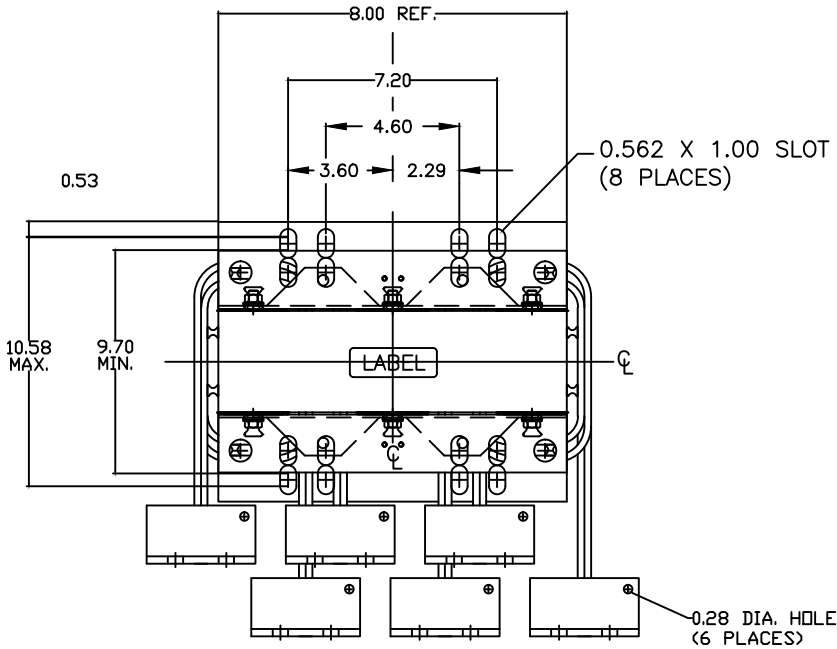

NOTES:
CENTER LINE REPRESENTS
CENTER OF REACTOR CORE

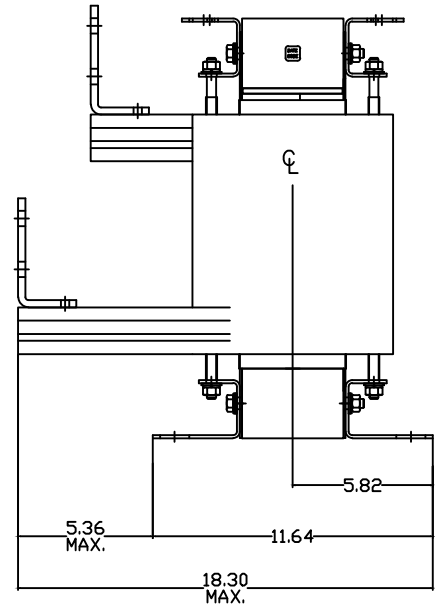
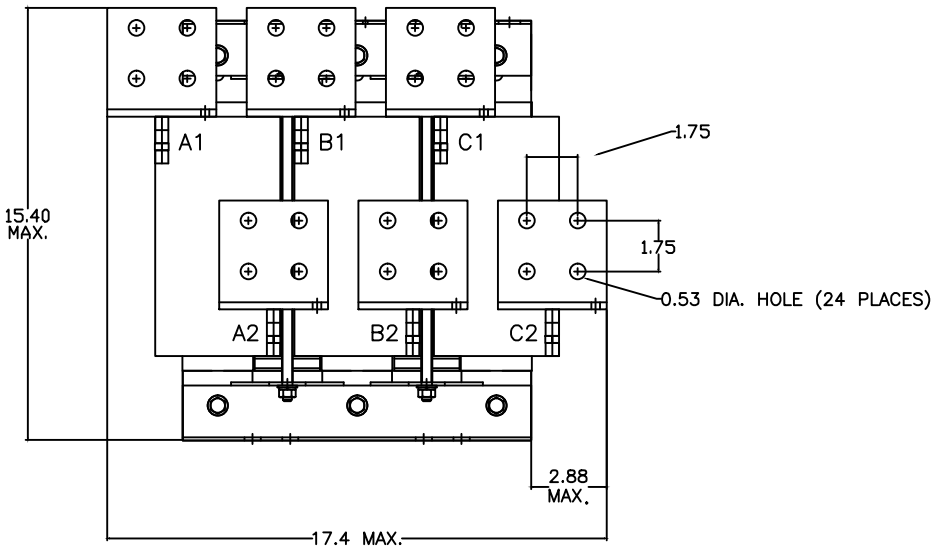

** ALSO AVAILABLE IN NEMA 1 ENCLOSURE

INDUCTANCE	WATTS LOSS	FUND. AMPS	MAX. AMPS	WEIGHT (LBS)
0.01 mH	1550.0	1200.0	1500.0	275



GE GRID SOLUTIONS
CLEARWATER, FL

SIZE

A

LV LINE REACTOR
37G120003B14

DRAWN DCS DATE 1/18/2017

ISSUED DATE 1/18/2017

SCALE

SHEET 1 CONT ON -