

SIZE A	DWG NO 37G13001	SHT 1	REV
REV	DESCRIPTION	DATE	APPROVED

3 Phase Line/Load Reactor  
OPEN FRAME

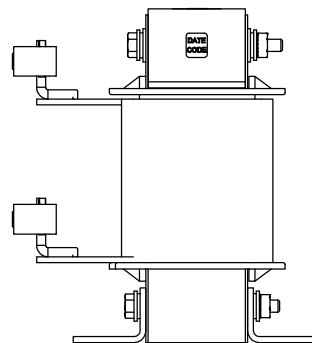
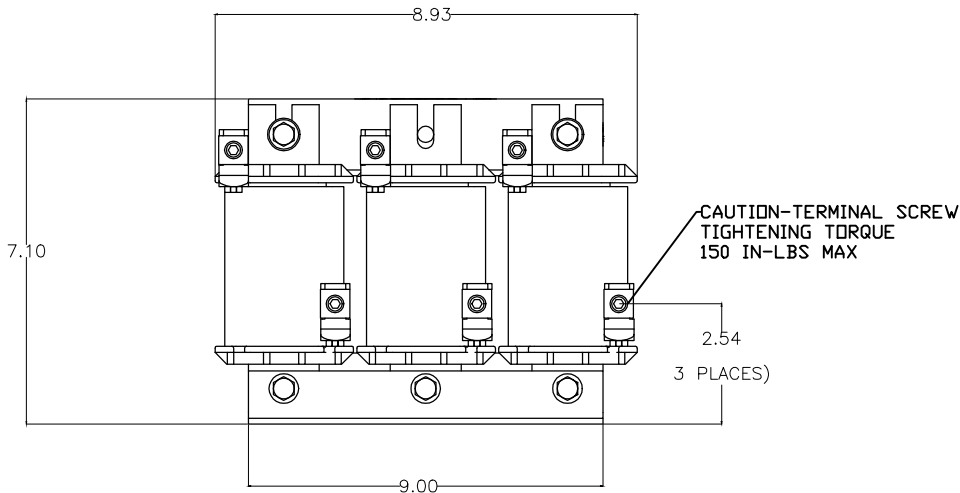
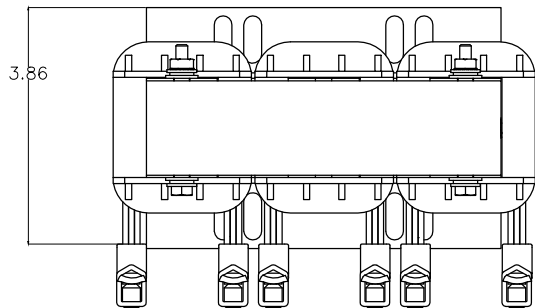

- NOTES:  
 1. TERMINAL SCREW TORQUE:  
 6-4 (45 IN-LBS MAX)  
 2-0 (50 IN-LBS MAX)  
 2. WIRE RANGE: 2-00000 AWG

\*\* ALSO AVAILABLE IN NEMA 1 ENCLOSURE

INDUCTANCE	WATTS LOSS	FUND. AMPS	MAX. AMPS	WEIGHT (LBS)
0.10 mH	108.0	130.0	195.0	29



GE GRID SOLUTIONS  
CLEARWATER, FL

SIZE

A

LV LINE REACTOR  
37G13001

DRAWN DCS DATE 1/19/2017

ISSUED DATE 1/19/2017

SCALE

SHEET 1 CONT ON -