

SIZE A	DWG NO 37G16001	SHT 1	REV
REV	DESCRIPTION	DATE	APPROVED

3 Phase Line/Load Reactor
OPEN FRAME

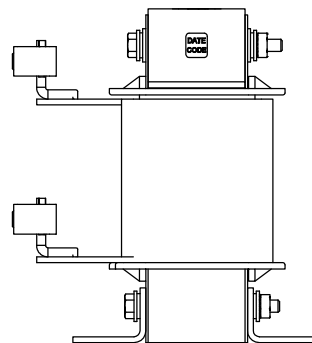
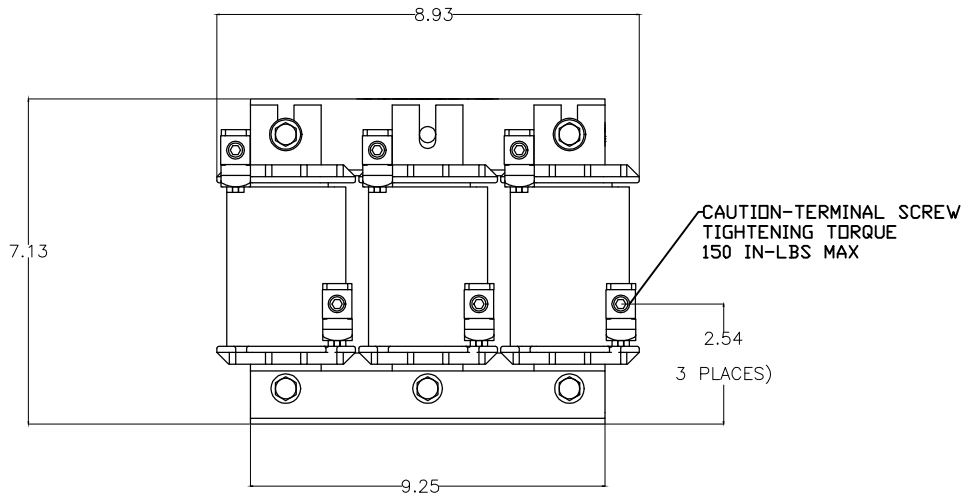
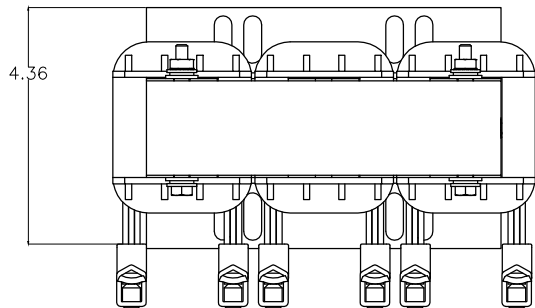

- NOTES:
 1. TERMINAL SCREW TORQUE:
 6-4 (45 IN-LBS MAX)
 2-0 (50 IN-LBS MAX)
 2. WIRE RANGE: 2-00000 AWG

** ALSO AVAILABLE IN NEMA 1 ENCLOSURE

INDUCTANCE	WATTS LOSS	FUND. AMPS	MAX. AMPS	WEIGHT (LBS)
0.1 mH	116.0	160.0	240.0	41



GE GRID SOLUTIONS
CLEARWATER, FL

SIZE

A

LV LINE REACTOR
37G16001

DRAWN DCS DATE 1/23/2017

ISSUED DATE 1/23/2017

SCALE

SHEET 1 CONT ON -