

SIZE A	DWG NO 37G16012	SHT 1	REV
REV	DESCRIPTION	DATE	APPROVED

3 Phase Line/Load Reactor  
NEMA 1 ENCLOSURE

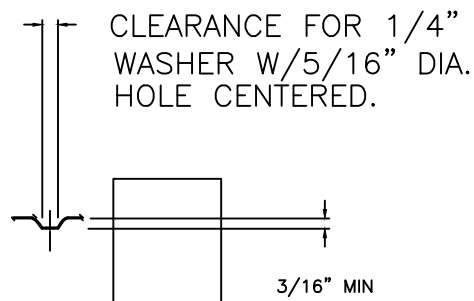

INDUCTANCE	WATTS LOSS	FUND. AMPS	MAX. AMPS	WEIGHT (LBS)
0.2 mH	149.0	160.0	240.0	69.0

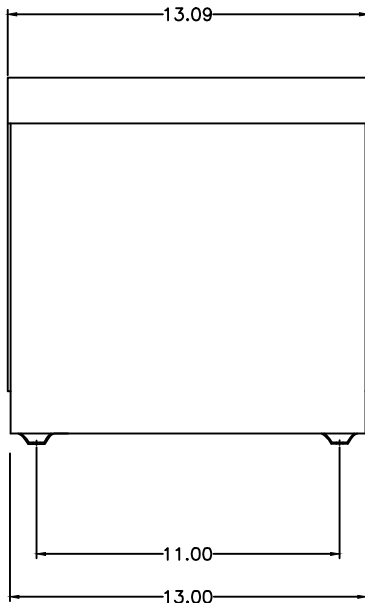
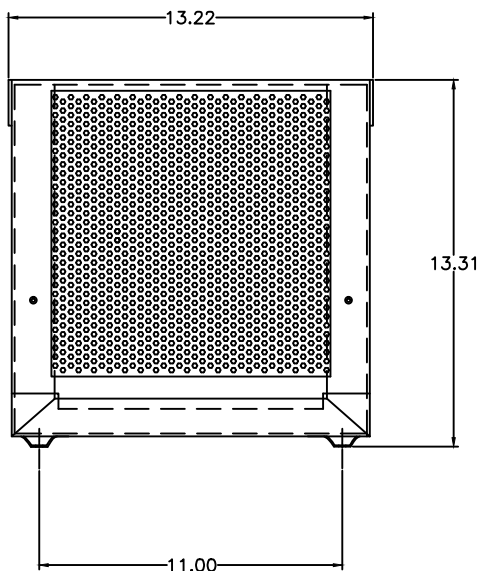

GE GRID SOLUTIONS  
CLEARWATER, FL

SIZE

A

LV LINE REACTOR  
37G16012

DRAWN DCS DATE 1/23/2017

ISSUED DATE 1/23/2017

SCALE

SHEET 1 CONT ON -