

SIZE A	DWG NO 37G20012B14	SHT 1	REV
REV	DESCRIPTION	DATE	APPROVED

3 Phase Line/Load Reactor
NEMA 1 ENCLOSURE

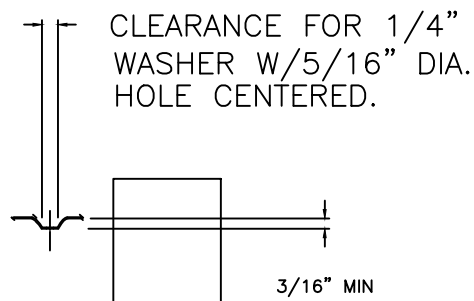

INDUCTANCE	WATTS LOSS	FUND. AMPS	MAX. AMPS	WEIGHT (LBS)
0.1 mH	168.0	200.0	300.0	72.0

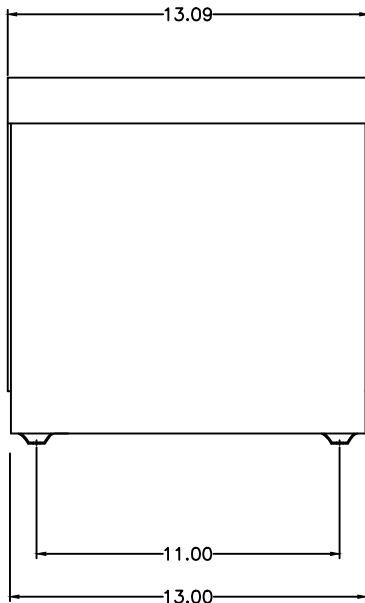
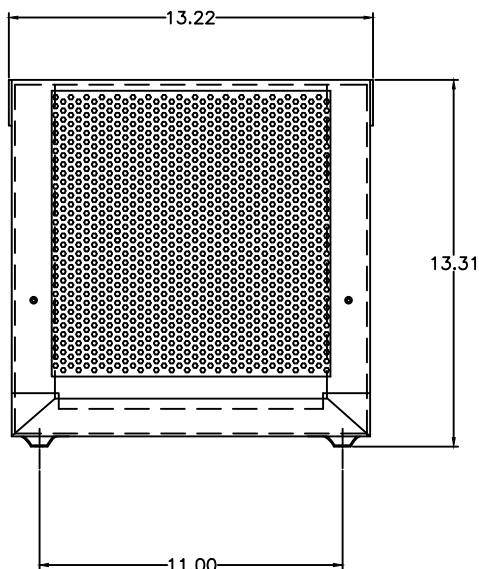

GE GRID SOLUTIONS
CLEARWATER, FL

SIZE

A

LV LINE REACTOR
37G20012B14

DRAWN DCS DATE 1/24/2017

ISSUED DATE 1/24/2017

SCALE

SHEET 1 CONT ON -