

SIZE A	DWG NO 37G40013B14	SHT 1	REV
REV	DESCRIPTION	DATE	APPROVED

3 Phase Line/Load Reactor
NEMA 1 ENCLOSURE

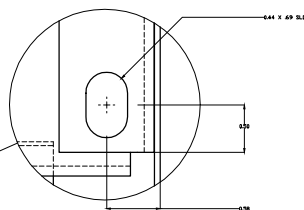
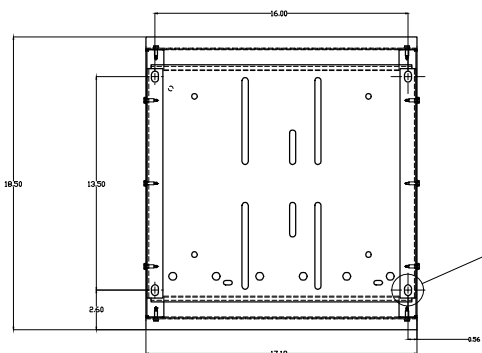
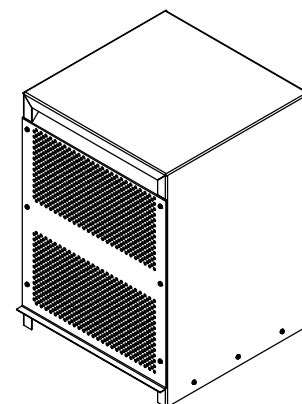
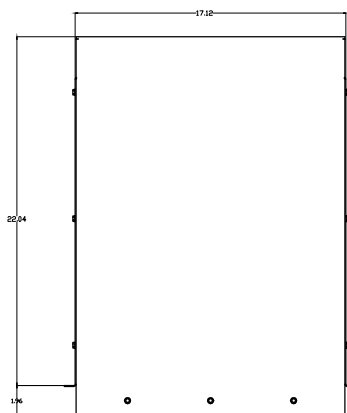
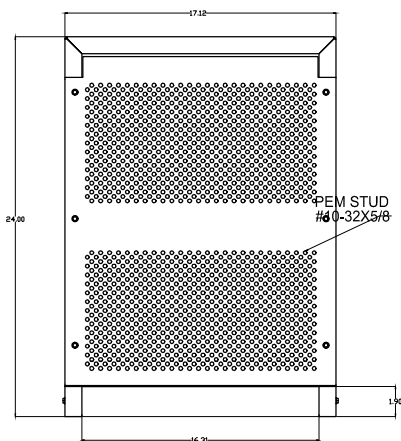

- HARDWARE INCLUDED:**
 NUT 1/4-20 HEX STEEL ZINC PLATED
 NUT 1/4-20 HEX STEEL ZINC PLATED
 SCREW 1/4-20X3/4 HEX STEEL ZINC PLATED
 WASHER 1/4 FLAT STEEL ZINC PLATED
 WASHER 1/4 SPLITLOCK STEEL ZINC PLATED
 WASHER #10 FLAT STEEL ZINC PLATED
 WASHER #10 SPLITLOCK STEEL ZINC PLATED
 NUT #10-32 HEX STEEL ZINC PLATED
 SCREW #10-32X3/4 RH STEEL ZINC PLATED
 SCREW #8-32X3/4 RH SLFT STL ZINC PLATED

- QTY 1
 QTY 4
 QTY 4
 QTY 8
 QTY 4
 QTY 4
 QTY 3
 QTY 3
 QTY 3
 QTY 2
 QTY 2

INDUCTANCE	WATTS LOSS	FUND. AMPS	MAX. AMPS	WEIGHT (LBS)
0.10 mH	293.0	400.0	600.0	173.0



GE GRID SOLUTIONS
CLEARWATER, FL

SIZE

A

LV LINE REACTOR
37G40013B14

DRAWN DCS DATE 1/25/2017

ISSUED DATE 1/25/2017

SCALE

SHEET 1 CONT ON -