

**AF-3061 & AF-3121
INVERTER DRIVE SYSTEMS
A-C ADJUSTABLE-SPEED DRIVE**

INSTALLATION

OPERATION



TROUBLESHOOTING

INVERTER AF3061

ABBREVIATED START-UP PROCEDURE

If any difficulties are encountered during start-up and checkout, refer to Section 4 of instruction book for detailed start-up and checkout procedure.

WARNING

ELECTRIC SHOCK CAN CAUSE PERSONAL INJURY OR LOSS OF LIFE. WHETHER THE A-C SUPPLY IS GROUNDED OR NOT, HIGH VOLTAGES TO GROUND WILL BE PRESENT AT MANY POINTS THROUGHOUT THE DRIVE. CHARGED CAPACITORS REQUIRE ONE MINUTE DISCHARGE TIME.

1. Verify that the 3-phase a-c power input to the drive is of the proper value as listed on the equipment data nameplate (-5,+10%).
2. Verify that cables P1 are disconnected and separated from conducting objects, from all 3 Phase Modules. Apply three phase a-c power to the Inverter, "POWER ON" indicator illuminates.

CAUTION

CHECK FOR PROPER AIR FLOW OF THREE PHASE BLOWER MOTOR (IF SUPPLIED). BLOWER ROTATION MUST BE COUNTER-CLOCKWISE LOOKING INTO BLOWER END. IF ROTATION IS INCORRECT, INTERCHANGE ANY TWO A-C SUPPLY LEADS TO BLOWER MOTOR.

3. Press the Inverter "START" pushbutton; "INVERTER ON" indicator illuminates (if supplied). "RESET" indicator (if supplied) should not be illuminated.
4. With the "Test" card in test socket "B" and the oscilloscope connected to "Read" apply a 10% to 20% speed reference command and verify that firing signals are present on 1B through 12B selector positions. Scope settings are: 5v/cm and 5 milli-sec/cm.
5. Press "INVERTER STOP/RESET" pushbutton. "INVERTER ON" indicator extinguishes.
6. Switch off or disconnect three phase input power to Inverter unit, "POWER ON" indicator extinguishes. Check that capacitors have discharged.
7. Connect P1 cables on all three phase modules.
8. Set "Speed Control" potentiometer to zero.
9. Apply three phase a-c power to the Inverter Unit. Verify that the "POWER ON" indicator is illuminated.
10. Press the Inverter "START" pushbutton; "INVERTER ON" indicator illuminates (if supplied).
11. Increase the "Speed Control" potentiometer until motor base speed is reached.

TABLE OF CONTENTS

SECTION	INDEX	PAGE
I	<u>GENERAL</u>	1-1
1.1	Scope of Manual.	1-1
1.2	Safety, Personnel and Equipment.	1-1
1.3	Warranty and Shipping.	1-3
II	<u>SYSTEMS EQUIPMENT DESCRIPTION</u>	2-1
2.1	Equipment Purpose	2-1
2.2	Equipment Furnished - General.	2-1
2.3	Equipment Functional Description	2-2
III	<u>INSTALLATION</u>	3-1
3.1	General.	3-1
3.2	Equipment Location	3-1
3.3	Tools Required	3-1
3.4	Mechanical Installation.	3-1
3.5	Electrical Wiring and Interconnection.	3-2
IV	<u>STARTUP AND CHECKOUT</u>	4-1
4.1	General	4-1
4.2	Test and Equipment Required	4-1
4.3	Power-Off Continuity Test.	4-1
4.4	No Load-Power Test.	4-2
4.5	No Load System Adjustments	4-6
4.6	System Adjustments Under Load	4-6
V.	<u>MAINTENANCE</u>	
5.1	Mechanical Inspection	5-1
5.2	Electrical Inspection	5-1
5.3	SCR or Rectifier Replacement Procedure	5-1
VI	<u>TROUBLESHOOTING</u>	6-1
6.1	General	6-1

TABLE OF CONTENTS (continued)

SECTION	INDEX	PAGE
VII	<u>SPARE PARTS RECOMMENDATION</u>	7-1
7.1	General	7-1
7.2	Recommended Spare Assemblies, Subassemblies and Printed Circuit Card/Boards	7-1
VIII	<u>DOCUMENTATION/DRAWINGS FURNISHED</u>	8-1
8.1	General	8-1

LIST OF ILLUSTRATIONS

FIGURE	INDEX	PAGE
2-1	Inverter Enclosure-Left hand door controls and Indicators (Typical Modifications)	2-7
2-2	Operator Station-Basic	2-8
2-3	Inverter Interior-Typical location of assemblies and components	2-9
2-5	Inverter Simplified Block Diagram-Identified modifica- tions options which may be supplied (if ordered) .	2-16
2-6	Driver Forward Loop	2-17
2-7	AF3061 Power Circuit (One Phase)	2-18
2-8	60HZ Base Frequency Operation	2-19
Fig. 1 to 25	Driver Signal Displays on Oscilloscope Fig. 1 to Fig. 25	8-2 to 8-15

LIST OF TABLES

TABLE	INDEX	PAGE
2-1	Function of Controls, Indicators and Assemblies	2-3
6-1	Startup Troubleshooting	6-5
6-2	Driver Troubleshooting	6-7

SECTION I
GENERAL

1.1 SCOPE OF MANUAL

This instruction manual is structured around a basic system. It is a guide for the installation, checkout and operation of the equipment furnished with general troubleshooting procedures for the basic system. Any special purpose equipment, as requested on the requisition, will normally be covered in the schematic drawings included with this package. These instructions do not purport to cover all details or variations in the equipment nor to provide for every possible contingency to be met in connection with the installation, operation or maintenance. Should further information be desired or should particular problems arise which are not covered sufficiently for the purchaser's purpose, the matter should be referred to the General Electric Company.

1.2 SAFETY, PERSONNEL, AND EQUIPMENT

The following paragraphs list some general safety reminders and safety recommendations to be followed when operating or installing this equipment.

Only authorized electrical and electronics personnel should install and maintain this equipment.

Definition of terms and sign colors:

WARNING: Denotes operating procedures and practices that may result in personal injury or loss of life if not correctly followed.

Color: Black or white lettering on red field.

CAUTION: Denotes operating procedures and practices that, if not strictly observed, will result in damage to, or destruction of, the equipment.

Color: Black lettering on amber field.

NOTE: Denotes an operating procedure or condition that should be highlighted.

Color: Black lettering on white field.

WARNING: HIGH VOLTAGE

ELECTRIC SHOCK CAN CAUSE PERSONAL INJURY OR LOSS OF LIFE. WHETHER THE AC VOLTAGE SUPPLY IS GROUNDED OR NOT, HIGH VOLTAGES TO GROUND WILL BE PRESENT AT MANY POINTS WITHIN THE SCR DRIVE. EXTREME CARE MUST BE EXERCISED IN THE SELECTION AND USE OF TEST INSTRUMENTS. OPERATOR SHOULD NOT STAND ON GROUNDED SURFACES OR BE IN CONTACT WITH GROUND WHEN APPLYING TEST INSTRUMENTS TO TEST POINTS. CONVENTIONAL TEST INSTRUMENTS SHOULD NOT HAVE CHASSIS GROUNDED WHILE TESTS ARE BEING MADE. THUS, THE CHASSIS CAN BE AT A HIGH VOLTAGE WITH RESPECT TO GROUND DURING TESTING. EXTREME CARE SHOULD BE TAKEN WHILE ATTEMPTING TO ADJUST, TROUBLESHOOT, OR MAINTAIN ANY DRIVE SYSTEM DESCRIBED HEREIN.

When working on or near the equipment with power/voltage applied, it is recommended that all metal objects such as rings, watches, and tie clasps be removed.

It is highly recommended that all personnel working on this equipment wear rubber soled shoes (insulated).

WARNING

WHEN WORKING AROUND ROTATING EQUIPMENT, DO NOT WEAR ANY LOOSE CLOTHING THAT COULD BECOME CAUGHT IN THE EQUIPMENT.

CAUTION

DO NOT REMOVE PRINTED CIRCUIT CARDS FROM THE EQUIPMENT WHILE POWER IS APPLIED OR OPERATING; THIS CAN DAMAGE THE EQUIPMENT.

NOTE

ALWAYS READ THE COMPLETE SUBSECTION (EXAMPLE, 3.2) PRIOR TO ANY TURN-ON OR TROUBLESHOOTING OF THE EQUIPMENT. FOLLOW THE PROCEDURE STEP BY STEP.

READ AND HEED ALL
WARNING, CAUTION AND NOTE
SIGNS POSTED ON THE EQUIP-
MENT.

1.3 WARRANTY AND SHIPPING

1.3.1 Warranty Statement

The Company warrants to the Purchaser that the equipment to be delivered hereunder will be free from defects in material or workmanship and will be of the kind and quality designated or specified in the contract.

This warranty shall apply only to defects appearing within one year from the date of shipment by the Company.

1.3.2 Receipt of Shipment

All equipment is factory inspected before shipment and is shipped in good condition. Any damages or shortages evident when the equipment is received must be immediately reported to the commercial carrier who transported the equipment. If required, assistance may be received from the General Electric Company, Speed Variator Products Department, but when seeking assistance, please use the purchase order number, requisition number, and model number to help us in assisting you.

SECTION II

SYSTEMS EQUIPMENT DESCRIPTION

2.1 EQUIPMENT PURPOSE

The AF-3061 Inverter Drive is an adjustable frequency a-c drive system designed for industrial applications where the use of a-c motors is desirable or required. Single motor operation or multi-motor group operation from a single power unit is standard. Adjustment of motor(s) speed results from changing the motor voltage and frequency.

2.2 EQUIPMENT FURNISHED - GENERAL

The AF-3061 Inverter Drive System consists of three basic parts as follows:

2.2.1 Power Unit

A floor mounted NEMA 1 ventilated enclosure housing the power, regulating and logic circuitry plus other required control devices. Input voltage: 230/460VAC, 3 phase, 60 hertz. Output voltage: 0 to 230VAC, 3 phase, 2 to 90 hertz (60 hertz base) - other frequency ranges are available.

2.2.2 Operator's Station

A NEMA 1 wall or machine mounted control station including the speed setting potentiometer or oscillator and "START-STOP/RESET" pushbuttons and any other command or monitor functions that were ordered for the operator's station.

2.2.3 A-C Drive Motor (s)

Up to one hundred horsepower, in accordance with NEMA ranges, Type KAF (optimized design) induction, three phase, 230 VAC, Dripproof or totally enclosed force cooled or explosion-proof enclosures with thermal protection for use in 10°C or 40°C ambient temperature range. Three base speed ranges are available with increased speed range capability. Motors are normally supplied with F1 position mounted conduit box.

2.2.4 Special Purpose Equipment

See Elementary Diagram.

2.2.5 Receiving, Handling and Storage

2.2.5.1 Receiving

The equipment should be placed under adequate cover immediately upon receipt as packing is not suitable for out-of-doors or unprotected storage.

2.2.5.2 Handling

Power units can be transported by lift trucks with the forks completely under the wooden shipping base. Crane lifting eyelets are supplied on the top of the unit for handling by a crane with a spreading bar used.

2.2.5.3 Storage

This equipment may be stored at ambient temperature of -20°C to 40°C for a period of up to one year. Air must be free of chemical and electrically conductive contaminants, and other conditions must be such that no moisture condensation occurs in or on the equipment.

In addition, when a control that has been in operation and will be shut down for either a short or extended period of time, it is recommended the environmental conditions be maintained the same as when in operation.

It is recommended that space heaters or equivalent devices be used to maintain the equipment in its normal operating environment (temperature).

Filter capacitors require forming after a three month or longer storage period.

2.3 EQUIPMENT FUNCTIONAL DESCRIPTION

This subsection provides a listing (in tabular form) of the controls, indicators and assemblies together with their functions and illustrations of the equipment. Also provided is a brief theory of operation at the system level.

2.3.1 Function of Controls, Indicators and Assemblies

Table 2-1, in conjunction with Figures 2-1 through 2-3, will give a listing of the controls, indicators and assemblies and their functions (the most often requested modification options are also included and are indicated by an asterisk*). The circled numbers/letters under "EQUIPMENT/ITEM" also appear on the illustrations, Figure 2-1.

2.3.2 Location of Controls, Indicators and Assemblies

Figures 2-1 through 2-3 will locate the majority of assemblies, controls and indicators.

TABLE 2-1 FUNCTION OF CONTROLS, INDICATORS AND ASSEMBLIES

EQUIPMENT/ITEM	CONTROL/INDICATOR	FUNCTION
<p>Inverter Door (Figure 2-1)</p> <p>①*</p> <p>②</p> <p>③*</p> <p>④*</p> <p>⑤</p> <p>⑥* (Not shown)</p> <p>⑦* (Not shown)</p> <p>⑧* (Not shown)</p> <p>⑨</p> <p>⑩* (Not shown)</p> <p>⑪* (Not shown)</p>	<p>Circuit Breaker "ON-OFF" Control Handle</p> <p>"POWER ON" Indicator</p> <p>"INVERTER ON" Indicator</p> <p>"START" Pushbutton (Normally on Operator Station) Fig. 2-2</p> <p>"STOP/RESET" Pushbutton (Normally on Operator Station) Fig. 2-2</p> <p>"RESET" Indicator (Fault)</p> <p>Ammeter</p> <p>Voltmeter</p> <p>Speed Control potentiometer (Normally on Operator Station) Fig. 2-2</p> <p>"FORWARD-REVERSE" selector switch (Normally on Operator Station) Fig. 2-2</p> <p>"RUN-JOG" (Thread) selector switch (Normally on Operator Station) Fig. 2-2</p>	<p>Controls application of three phase, a-c power input to the drive system, plus indication of power shutdown trip.</p> <p>Provides a visual indication that the input power is applied to the drive system.</p> <p>Provides a visual indication that the "START" pushbutton has been pressed and the IS relay has energized and there are no "faults" in the system.</p> <p>Applies 115VAC to the Inverter Start (IS) relay coil.</p> <p>Interrupts 115VAC to the IS relay coil which causes the IS and auxiliary relays to de-energize which shuts the system down and extinguishes the "INVERTER ON" indicator.</p> <p>Provides a visual indication that the system has shutdown due to the "fault monitor" protection circuitry. (The "INVERTER ON" indicator will extinguish.)</p> <p>Displays T1 output current from Phase One Inverter Module to the motor(s).</p> <p>Displays a-c output voltage from Inverter Module to motor(s).</p> <p>Provides a means of selecting the operating speed of the motor.</p> <p>Provides a means of reversing the direction of motor rotation.</p> <p>Provides a means of selecting a preset speed point for momentary operation by holding the "START" pushbutton depressed when in the "JOG" position.</p>
<p>Inverter Interior (Figure 2-3)</p>	<p>See Figure 2-3 for location of Assemblies and Devices</p>	
<p>+20VDC Power Supply Card (no adjustments)</p>		<p>Supplies +20VDC and a -20VDC for cards and circuits operating power. Fused inputs FU1 and 2.</p>
<p>+5VDC Power Supply Card (no adjustments)</p>		<p>Supplies +5VDC for digital logic circuitry in the Inverter. Fused input on card.</p>

*Identifies modification options which may be supplied (if ordered).

TABLE 2-1 FUNCTION OF CONTROLS, INDICATORS AND ASSEMBLIES

EQUIPMENT/ITEM	CONTROL/INDICATOR	FUNCTION
Isolator/-5VDC Power Supply Card		Provides voltage feedback isolation. Provides -5VDC for -5V reference. Provides firing power (delayed) for pulse transformers. Provides an RX relay for Inverter on-off readout. Provides under and overvoltage trip signal.
Monitor Card	<p>“Fault Monitor” Indicator (Trip) (IOC indicator will also illuminate.)</p> <p>“Fault Monitor” indicator (IOC)</p> <p>“Monitor” indicator (CL)</p> <p>“Monitor” indicator (1FFA)</p> <p>Test Connection #1 (FILTER)</p> <p>Test Connection #2 CCA</p> <p>Test Connection #3 CCB</p> <p>Test Connection #4 CCC</p> <p>Test Connection #5 1FFA</p> <p>Test Connection (COMM)</p>	<p>Provides test points for test instruments and for indicating lights.</p> <p>Provides a visual indication that the Drive Protection Trip circuit has actuated due to a fundamental over-frequency or high-low d-c buss condition or momentary loss of 115VAC.</p> <p>Provides a visual indication that the Drive Protection IOC circuit has actuated due to an Instantaneous overcurrent condition.</p> <p>Provides a visual indication that the drive is operating in a current limiting condition.</p> <p>Provides a visual indication that the fundamental frequency is present from the three phase generator.</p> <p>Provides test instrument access to the Filter Module Current Feedback.</p> <p>Provides test instrument access to Commutation Current Feedback from phase A Inverter Module.</p> <p>Provides test instrument access to Commutation Current Feedback from phase B Inverter Module.</p> <p>Provides test instrument access to Commutation Current Feedback from phase C Inverter Module.</p> <p>Provides test instrument access to the Fundamental Frequency, phase A, three phase generator output. (Same signal that drives light 1FFA).</p> <p>“Common” for preceding five test points.</p>
“AC Regulator” Card	<p>Stability adjust potentiometer</p> <p>Volts/hz adjust potentiometer</p> <p>Minimum Frequency adjust potentiometer</p> <p>Current Limit adjust potentiometer</p>	<p>Provides the input reference conditioning with a proportional output for the selected base frequency in synchronization with a master oscillator output plus the three phase generator outputs.</p> <p>Provides a means of varying the response of the reference input amplifier.</p> <p>Provides a means of adjusting the Inverter output volts per hertz in a 15% band about rated.</p> <p>Provides a means of setting the master oscillator lower frequency operating point. (Below min. freq. only output voltage is reduced).</p> <p>Provides a means of setting the current limiting circuit from 50% to 150% of drive rated current.</p>

TABLE 2-1 FUNCTION OF CONTROLS, INDICATORS AND ASSEMBLIES

EQUIPMENT/ITEM	CONTROL/INDICATOR	FUNCTION
Reverse Logic Card	Voltage Boost adjust potentiometer Slip Comp. adjust potentiometer I. R. Comp. adjust potentiometer Time-up adjust potentiometer Time-down adjust potentiometer	Provides a means of increasing the input voltage reference independent of frequency (if ordered). Provides timed acceleration and deceleration for a voltage input reference, selective phase current sensing, motor compensation signals and a current limit signal. Also motor reversing (if supplied). Provides a means of compensating for motor slip (if ordered). Provides a means of compensating for voltage loss due to motor load (if required). Provides a means of setting the acceleration time to 80/160 hz from 2 to 32 seconds with analog input only. Provides a means of setting the deceleration time from 2 to 32 seconds depending on load with analog input only.
Drive Modulator Card		Provides the driving signals to the three commutation cards and instantaneous current limit which reduces the current output.
Synchronizer II Card		Provides pulse train to commutation cards for firing pulses; triangle and square waves for synchronization signals and current feedback signal amplification.
Test "B" Receptacle		Provides a receptacle to receive the Test Function Card. (See Table 6-2 for Test B monitored signals).
Test "A" Receptacle with Test Function Card shown		Provides a receptacle to receive the Test Function Card. (See Table 6-2 for Test A monitored signals.)
Test Function Card	+20VDC Test Connection Delayed Firing Power (DFP) Test Connection Select (SEL) Test Connection. -5V DC Test Connection	Provides external test equipment connection points for monitoring of Inverter signals and power supply voltages. All test connections except "COM" have a 15k ohms impedance to the signal being monitored. Provides monitoring access to +20V power supply. Provides access to the delayed Firing power signal. Provides the capability of a reconnectable test point that can be internally connected (to back of Driver Receptacles) to any point for monitoring. (Normally connected to its self at time of shipment). Provides monitoring access to -5V power supply.

TABLE 2-1 FUNCTION OF CONTROLS, INDICATORS AND ASSEMBLIES

EQUIPMENT/ITEM	CONTROL/INDICATOR	FUNCTION
<p>Drive Protection Card</p> <p>Commutation Cards for phases A, B and C</p> <p>Shown in Fib. 2-2 located on lower cover panel of Driver Assembly</p> <p>Divider Card</p>	<p>+5VDC Test Connection</p> <p>-20VDC Test Connection</p> <p>Thumb Wheel Selector Switch</p> <p>"Read" Test Connection</p> <p>"Common" Test Connection</p>	<p>Provides monitoring access to +5V power supply.</p> <p>Provides monitoring access to -20V power supply.</p> <p>Provides a means of selecting pre-wired test points 1 through 19 (A or B test receptacles) to test a point "Read" and "Common".</p> <p>Provides access to signal selected (1-19) of Thumb Wheel Selector Switch.</p> <p>Provides access to system "Common" for the above listed signal test connections.</p> <p>Provides driver logic to insure proper conditions exist before allowing firing pulses to be applied to the power conversion modules; under or over d-c buss voltage trip signal; driver trip signal for fundamental frequency upper limit and firing and lockout signals for an instantaneous over-current (IOC) condition.</p> <p>Provides for: proper firing coordination of main Inverter SCR's; proper firing of the commutating SCR's; execution of driver trip signals initiate starting and stopping of firing pulses to all SCR's and power modules and generation of a "Recalibrate" signal to the Drive Protection card to increase the IOC level during commutation.</p>
	<p>Minimum Speed adjust potentiometer</p> <p>Maximum Speed adjust potentiometer</p>	<p>Provides a means of setting minimum (lower limit) of motor(s) speed when an analog "speed control" voltage input is used.</p> <p>Provides a means of setting maximum (upper limit) of motor(s) speed when an analog "speed control" voltage input is used.</p>
		<p>Divides down frequency of master oscillator. Generates 3 phase logic signal that is either 1/96, 1/48 or 1/24 master oscillator frequency for ranges X1, X2, X4 respectively. Selects optimum chop frequency ratio.</p>

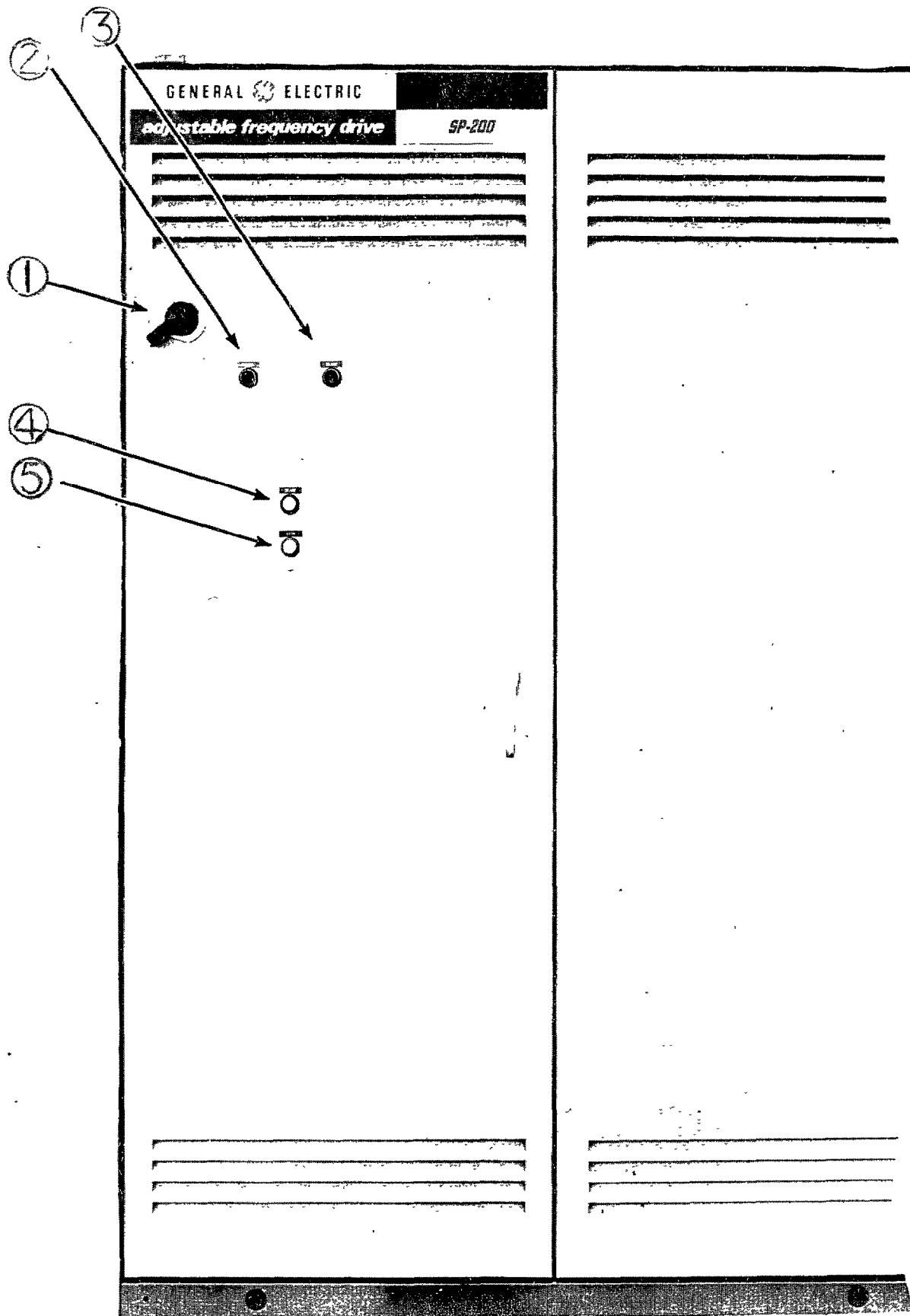

Figure 2-1 INVERTER ENCLOSURE
Left Hand Door Controls and Indicators (Typical Modifications)

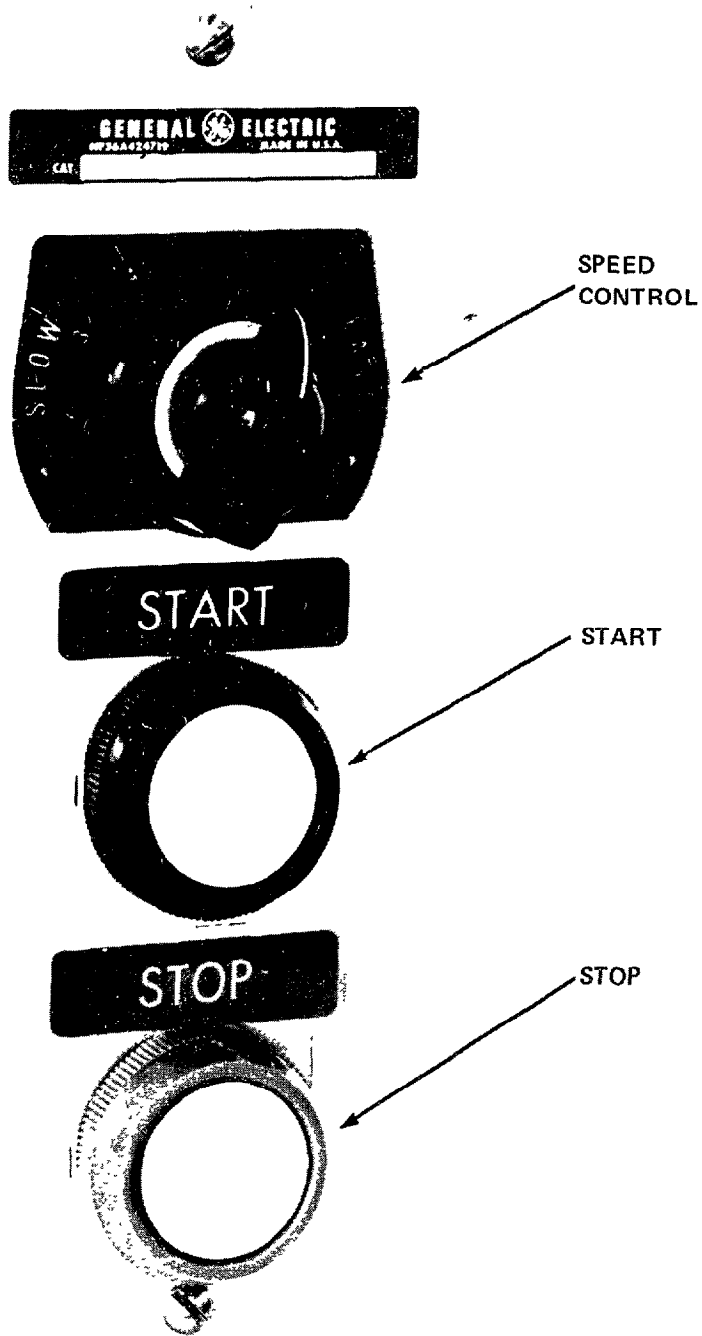
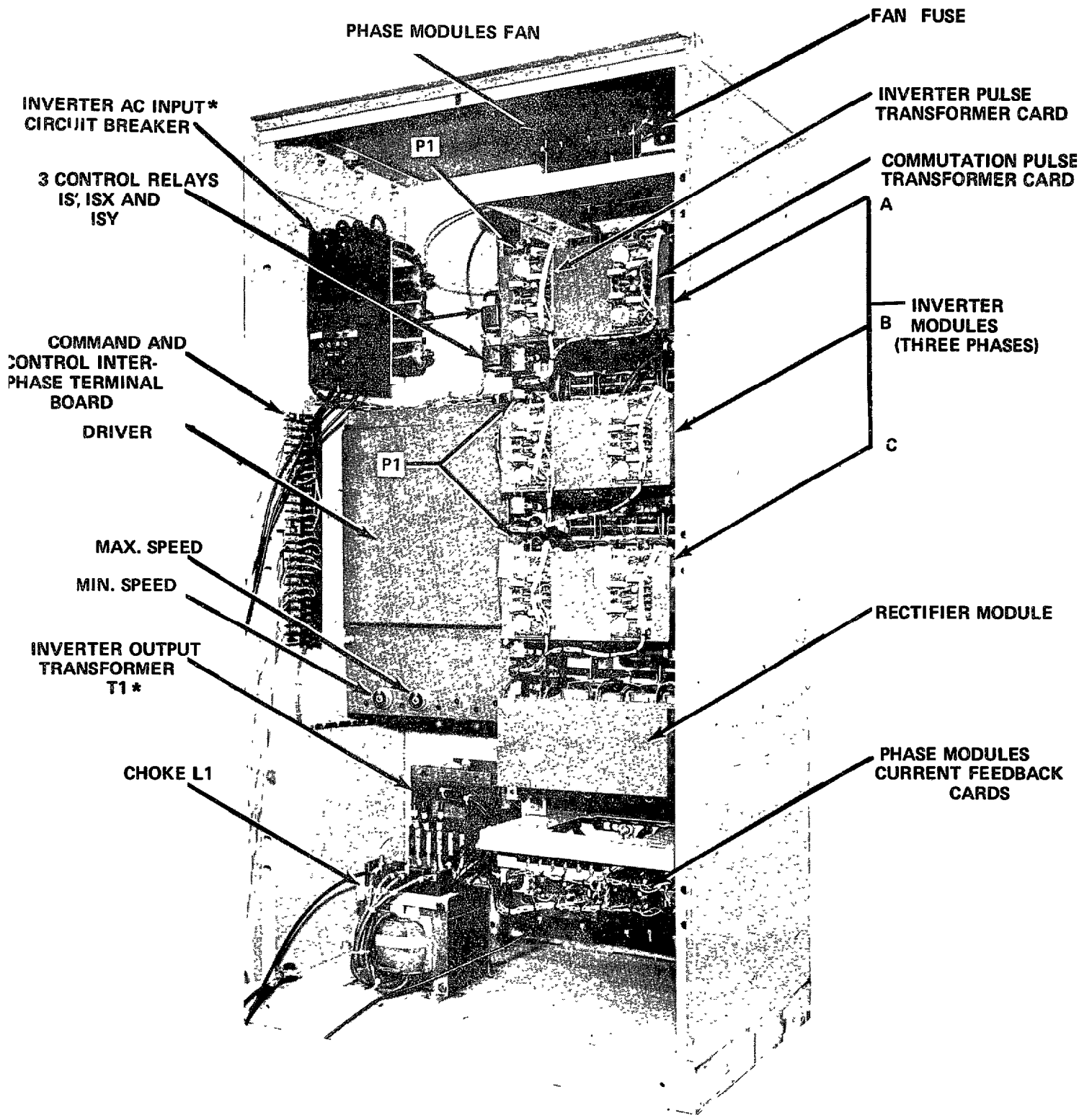

FIGURE 2-2 OPERATOR
STATION - BASIC



INVERTER INTERIOR

FIGURE 2-3

2.3.3

Theory of Operation

To best understand the theory of operation of the AF-3061 Inverter Drive System the simplified block diagram (Figure 2-5) should be referred to when reading this section.

The total system can be divided into five parts for a clearer understanding. The five parts are: command and logic, rectifier, driver, filter and power conversion modules and a-c motor (s). The following is a brief description of the functions of each of the five parts of the system.

2.3.3.1 Command and Control Logic and System Protection Circuitry

This part of the system circuitry contains all the operators controls and indicators with their associated relays and logic, input power devices, 115VAC control power, and system protective devices such as fuses, thermal switches and system fault logic indication.

The three phase, 230 volt a-c power enters the power unit through current limiting fuses (one per input phase) and is fed directly to the three phase full-wave rectifier bridge. The incoming a-c power is transient filtered by the a-c suppression assembly (TSM). Also tapped off a-c input from two phases is 115 volt control power from the control power transformer 1T. 115 volt control power from the transformer is fused by FX1 and is used for all operators control devices and relays except for the speed reference signal. POWER ON indicator may be connected across two of the three phases on the power unit side of the of the three input fuses.

CAUTION

THE POWER ON INDICATOR IS NOT A TRUE INDICATION OF THE PRESENCE OR ABSENCE OF HIGH VOLTAGE IN THE UNIT. WHEN FUSE OR LAMP FAILURE OCCURS HIGH VOLTAGE CAN STILL BE PRESENT IN THE UNIT. VERIFY THAT EXTERNAL DISCONNECT SWITCH IS OFF PRIOR TO CHANGING FUSES OR CHECKING LAMP.

115 volt a-c control power is fed through the motor thermal

switches (unless otherwise specified) where it is fed into the "Stop-Start" operation devices and their associated relays. For the exact circuit connection, consult the elementary diagram furnished. Typical control logic for an inverter system is as follows: When the Start button is actuated the inverter start relay (IS) is actuated and sealed in by IS contacts paralleling the "Start" button. Another set of IS contacts closes actuating the inverter start auxiliary relay. The inverter relay (RX) has contacts in the INVERTER ON indicator circuit (if supplied) and the RESET indicator (if supplied). A set of N.O. contacts may be in the speed reference input circuit to the driver which will open in case of a loss of 115VAC control power, which will remove the input speed reference command. Inverter ON and Reset indicator logic is as follows: If no fault exists in the system (RX relay), the Inverter ON indicator will illuminate when the START button is actuated, but if a fault exists in the system or a fault should occur in the system while operating in INVERTER ON indicator will extinguish and RESET indicator will illuminate.

NOTE

WHEN THE RESET INDICATOR ILLUMINATES (IF SUPPLIED) OPEN THE DRIVER COVER AND CHECK THE FAULT MONITOR INDICATORS ON THE MONITOR CARD (WILL INDICATE TYPE OF TRIP) PRIOR TO RESETTING THE INVERTER SYSTEM BY PRESSING THE "STOP/RESET" PUSHBUTTON.

2.3.3.2 Rectifier Module

The Three phase, 230 VAC power is fed directly from the three line fuses into the rectifier module. The rectifier module utilizes a three phase full-wave diode bridge which converts the a-c voltage to d-c voltage. The 310 VDC output is fed directly to the filters and three inverter phase modules.

2.3.3.3 Driver Assembly

Reference Figure 2.6 for the following signal paths while reading this paragraph.

Either a voltage or frequency (speed) reference is applied to the Drive Assembly. A voltage reference goes through a linear timing function on the Reverse Logic card and then to a voltage controlled oscillator on the AC regulator card. A frequency reference is fed directly to a discriminator on the AC Regulator card. The discriminator produces a voltage proportional to the reference for the voltage controlled oscillator (VCO).

A variable frequency pulse train from the oscillator is fed to the driver card where the frequency is divided by sixteen, 8 or 4 for BFX1, X2 or X4. This frequency is six times the fundamental frequency of the drive. This signal goes to a Three Phase generator on the Divider card. This generator produces a Three Phase square wave plus the inverse of each phase... (phases at this point are labeled X, Y, and Z). Phase X and its inverse is fed directly to the Driver Modulator card where it becomes Phase A. Phases Y and Z are fed to the Reverse Logic card. This card switches Phases Y and Z between Phases B and C. See table for phase relation.

PHASE	FORWARD	REVERSE
X	A	A
Y	B	C
Z	C	B

The Reverse Logic card also produces the inverse of Phases B and C.

All three phases and their inverse are fed into a multiplexer on the Drive Modulator card. This card also receives a signal called "Modulator Voltage" (MV) from the AC Regulator card.

This modulator voltage along with a voltage feedback is fed into a switching regulator to create the chopping for the pulse width modulator. This chopping is fed into the multiplexer along with the Three Phases and their inverse. (For low frequency the entire cycle is pulse width modulated.) The output is a Three Phase square wave with the center portion of each half cycle pulse width modulated. The phase signals are fed into three Commutation cards which coordinates the firing signals to the four SCR's per phase so that a power phase will be produced similar to the PWM signal out

of the Modulator card.

Figure 2.6 shows the Driver feedback signals

There also is a frequency feedback from the Synchronizer II card that is half the frequency of the oscillator on the AC Regulator card. This feedback goes to the discriminator and is only meaningful when a frequency reference is used. Using this feedback means that the incoming frequency reference must be forty-eight, 24, or 12 times the fundamental frequency for base frequency ranges of X1, X2 and X4 respectively.

Voltage feedback comes from the d-c buss. This voltage is isolated, scaled down, and fed to the switching voltage regulator on the Modulator card. The Isolator card also produces a "TRIP" signal on "under" and "over" voltage conditions. This signal is fed to the Driver Protection card where the appropriate signals are sent to the Commutation cards to trip the drive. Voltage feedback is also fed to Synchronizer II card where it is combined with other signals for optimum chopping control.

Current feedback signals from each phase are fed to signal amplifiers on the Synchronizer II card. These signals are in phase with their respective driver phase signals. (i.e. CSA is in phase with 1FFA.) These current signals are fed to the Reverse Logic card where the components of current in phase with their respective voltage signals are summed. This sum is fed into a spill-over circuit and the resultant current limit signal is fed back to the AC Regulator card where it will over-ride the reference to limit current. The current signals from the Synchronizer card are also fed to the Commutation cards. Here the current signals are compared with a preset upper level (+5.5V). The result over-rides the voltage regulator to immediately increase or decrease output voltage to limit current. This instantaneous current limit will normally not be activated. This limit serves only to protect the drive under shock loads or a motor "Breakdown" (Induction) or "Pull Out" (Synchronous) condition.

There is also a current feedback from the drive Filter. Capacitor current is detected since any fast rising fault will first show up as capacitor current. This current signal is fed to a level detector to detect instantaneous over-current. When this signal reaches a pre-set upper level, the Drive Protection card stops all normal

firing and initiates a firing of all Inverter SCR's. This allows all power conversion modules to commutate off by means of a secondary commutation circuit.

Commutation current is fed back to each Commutation card. This signal is referenced at -5 volts and is used to coordinate the firing of the main inverter SCR's.

There are several coordinating signals in the driver that are explained here:

- OMV This is a logic signal that goes to the "0" state when the drive is at minimum voltage. This signal is used to coordinate starting, stopping and reversing.
- FV This is a voltage signal that is proportional to frequency (10V = 80hz). It is used in the optimum chopping control circuit.
- TW The triangle wave is used to synchronize the chopping in the switching regulator to the fundamental frequency.
- OFT The firing train oscillator is a series of low pulses and is used to insure the main SCR's are fired.
- O START
RELAY This is a buffered logic input and must be put in the zero state to start the drive.
- O RUN This signal goes to the zero state when the inverter is ready to run. It is used to lift the clamp on the reference.
- OSI The signal is used to start and stop commutation and inverter firing pulses.
- DFF This is the firing power supply. It goes directly to the pulse amplifiers in the conversion modules.
- O REV This is a buffered logic input with pre-conditioning that is used for reversing.
- IOCR This is a current signal and is used to recalibrate the IOC level during commutation.

OTRX &
OTRP The signals are used to trip the drive through
 the primary commutating circuit.

1IOCL &
OIOCP These signals are used to initiate an IOC trip
 and lockout using the secondary commutation
 circuit.

2.3.3.4 Inverter Assembly

The d-c power from the rectifier module is filtered by the filter and is applied to the SCR's where it awaits the proper gate signals to allow conduction. The phase modules consist of pulse transformer cards, main inverter SCR's (2 each), commutation diodes (2 each), and commutation SCR's (2 each). Upon receiving the proper firing commands from the commutation card in the driver, these SCR's fire (conduct) in the proper sequence to supply three phase alternating power to the motor(s). This power is variable in voltage and frequency. Reference Figure 2-7.

2.3.3.5 AC Motor(s)

The motor(s), either induction or synchronous, react to the amount of conduction that the SCR's have allowed. The output of the SCR's to the motor, is variable in frequency and voltage and is controlled by the "Speed Control" input reference setting. Each motor input phase is spaced 120 degrees in time (per cycle) from the preceding phase; phase A to phase B 120° apart, B to C 120° apart. Reference Figure 2-8 for motor per phase wave shapes.

2.3.3.6 Direct Paralleling Inverter Assemblies

When two or more inverter assemblies are used to provide a higher KVA rating, the only equipment addition is a Signal Distribution Assembly (SDA) which provides a means of distributing the firing signals to the modules and combining the feedback signals to the driver. Also supplied are three interphase transformers for load sharing. For exact information on circuits and connections, consult the elementary and assembly diagrams.

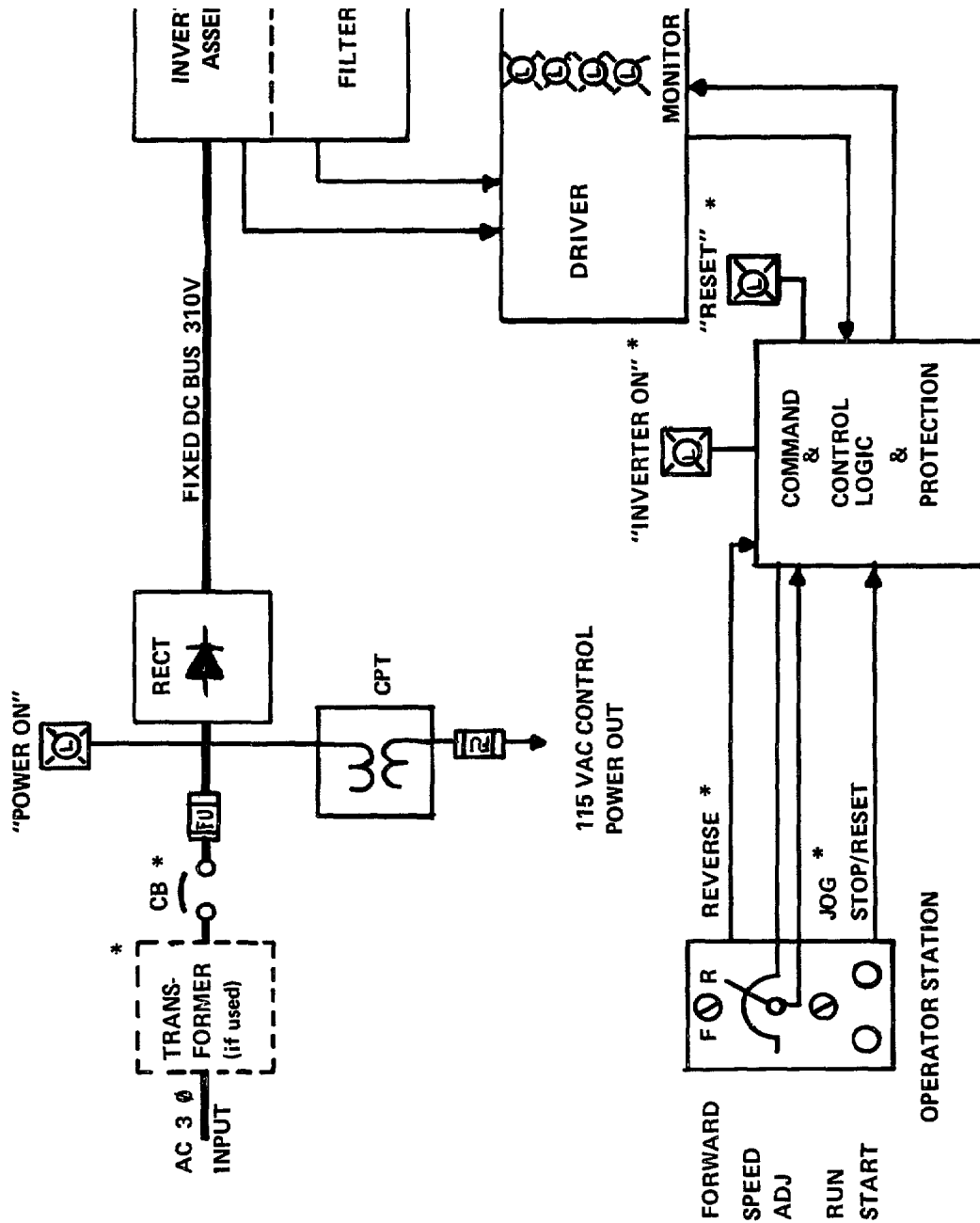

FIGURE 2-5 INVERTER SIMPLIFIED BLOCK DIAGRAM

* IDENTIFIES MODIFICATIONS OPTIONS WHICH MAY BE SUPPLIED (IF ORDERED).

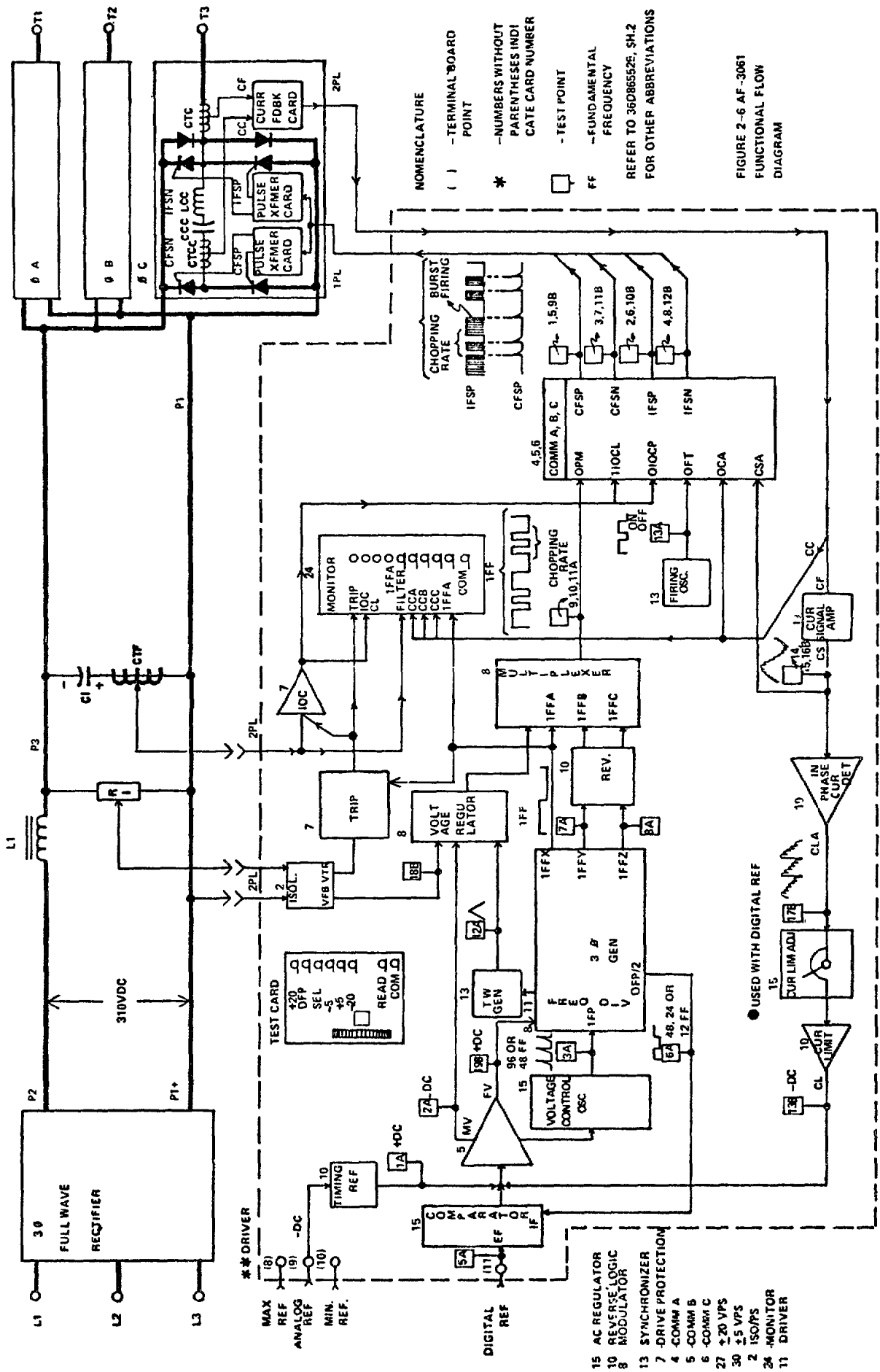

FIGURE 2-6 AF-3061
FUNCTIONAL FLOW
DIAGRAM

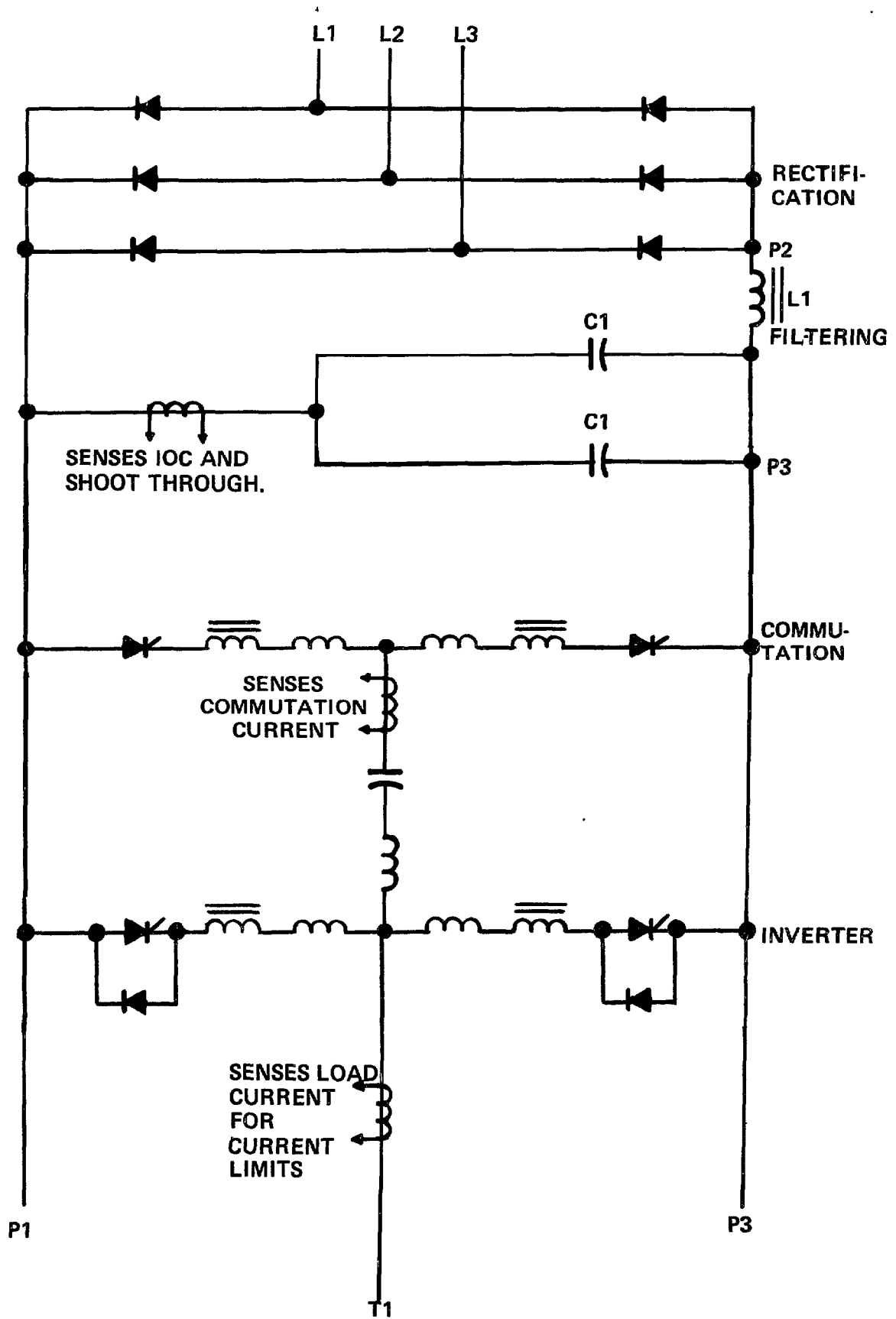
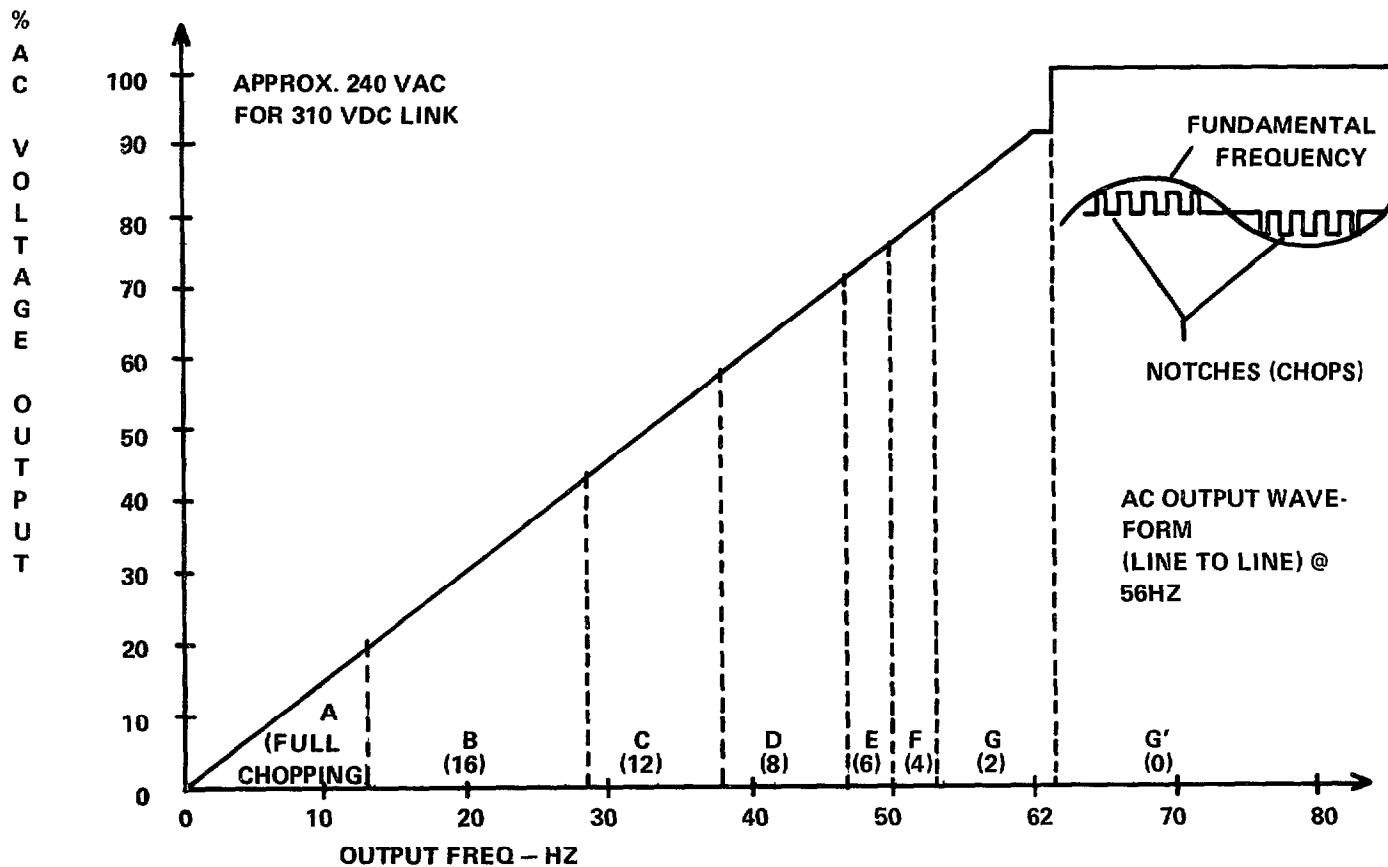

FIGURE 2-7 AF3061 POWER CIRCUIT (ONE PHASE)



NOTE: NUMBER (IN BRACKETS) UNDER LETTERS A THRU G ZONES INDICATES THE NUMBER OF NOTCHES (CHOPS) PER HALF CYCLE OF OPM SIGNALS. THE VERTICAL DASHED LINES INDICATE THE SHIFT POINTS.

FIGURE 2-8 60HZ BASE FREQUENCY OPERATION SHOWN

SECTION III INSTALLATION

3.1 GENERAL

All internal electrical connections between devices in the power unit have been made at the General Electric factory.

3.2 EQUIPMENT LOCATION

Speed Variator power units equipped with filters are suitable for most factory areas where other industrial equipment is installed. Locations subject to steam vapors or excess moisture, oil vapor or chemical fumes should be avoided. The power unit has filters and a blower system. The filters should be changed or cleaned before they become clogged. Power units should be installed in a well-ventilated area in an ambient temperature range from 10°C to 40°C (104°).

WARNING

EQUIPMENT SHOULD NEVER BE
INSTALLED WHERE HAZARDOUS,
INFLAMMABLE OR COMBUSTIBLE
VAPORS OR DUSTS ARE PRESENT.
SUFFICIENT CLEARANCE IN
FRONT OF THE UNITS SHOULD
BE ALLOWED FOR THE ACCESS
OF MAINTENANCE OR REPAIR.

3.3 TOOLS REQUIRED

The normal electrical and mechanical tool boxes maintained in most factories are all that is required for the installation of this equipment.

3.4 MECHANICAL INSTALLATION

Normally there are three types of equipment that require mechanical installation; power unit, operator's station and motor(s).

3.4.1 POWER UNIT

Cases may be bolted down using 3/8 diameter mounting bolts or studs. If studs are cast in floor, they should extend 3 1/2" minimum above floor. Conduit entry openings through base are fitted with removable sheet steel covers. Other conduit entry area available through top of case.

CAUTION

IF CONDUIT ENTRY OPENINGS
ARE TO BE CUT IN TOP OF
CASE, ADEQUATE PRECAUTIONS
SHOULD BE TAKEN TO PREVENT
METAL PARTICLES FROM ENTER-
ING ELECTRICAL DEVICES AND
COMPONENTS.

3.4.2 OPERATOR'S STATION

The operator's station must be disassembled for mounting and wiring. First, remove the two screws securing the cover to the operator's station enclosure and then remove the cover (with control devices mounted on the cover) from the enclosure.

When using either rigid or thin wall conduits, it is generally easier to attach the unit to the end of the conduit before locating and installing the mounting screws.

Mount the operator's station on any firm, reasonably flat, vertical surface by means of mounting holes in both top back and bottom back of enclosure. The operator's station is suitable for either wood screws or #10 machine screws.

3.4.3 AC MOTOR(S)

A separate instruction book is provided giving information on location, conduit entrance and mounting of the motor(s). The motor(s) should be mounted on the driven machine (or as appropriate for the installation) before proceeding with wiring, set up and adjustment.

3.5 ELECTRICAL WIRING AND INTERCONNECTION

All wiring shall be in accordance with the National Electrical Code and be consistent with all local codes. All internal electrical connections between components and the Speed Variator power units were made at the General Electric factory. When installing speed variators, all connections should be checked for tightness. Connections may become loose in shipping or storage. A diagram

showing the connections between the power unit and the related components is furnished with each equipment. All terminals to which the external connections are to be made are numbered on the diagram. The equipment should be wired as per the interconnection diagram and verified by continuity tests. It is recommended that as each connection or wire is connected to the equipment it be checked off on the interconnection diagram.

WARNING

ALL MOTOR BASES AND EQUIPMENT ENCLOSURES HOUSING SHOULD BE CONNECTED TO THE FACTORY OR FACILITY EARTH GROUNDING SYSTEM.

3.5.1 MOTOR(S) CONNECTIONS

For proper motor(s) connection, connect at motor(s) end as indicated on the motor(s) connection diagram plate for proper voltage connection. Wire sizes should be selected in accordance with NEMA standards based on the motor(s) nameplate data. Be sure to connect motor thermal switch back to the power unit. Tape all motor connections,

3.5.2 POWER UNIT CONNECTIONS

Electrical codes generally require the use of a fused disconnecting switch or circuit breaker in the a-c power line ahead of the SCR drive and transformer (if used). The disconnecting switch and fuse (or circuit breaker) should be selected in accordance with the National Electrical Code and/or local code requirements based on the power input data on the power unit nameplate. If any additional relays are added to the system, R.C. suppression networks must be added across the relay coils.

3.5.3 OPERATOR'S STATION CONNECTIONS

Using the interconnection diagram make all the required wiring connections between devices and the operator's station and the connections to the power unit. Reassemble the operator's station. Carefully dress the interconnecting wire into the back of the station so that the device assembly may be installed. Keep the wires away from sharp edges and do not force the device assembly into place. Replace the station cover and secure with cover retaining screws.

SECTION IV
STARTUP AND CHECKOUT

4.1 GENERAL

This section is written in a step by step approach to start up a single inverter module (3 phase) Inverter Drive System. If during the course of startup and checkout a step/indication cannot be performed, refer to Section VI, TROUBLESHOOTING, Table 6-1. This Troubleshooting table is written to follow each startup step in sequence.

WARNING

IF DOOR INTERLOCKS (IF SUPPLIED)
ARE DEACTIVATED OR BYPASSED, EXTREME
CAUTION MUST BE USED - BE SURE TO
REMEMBER TO RETURN INTERLOCKS TO
OPERATING CONDITION AFTER MEASURE-
MENT OR TROUBLESHOOTING.

4.2 TEST EQUIPMENT REQUIRED

The following listed test equipment should be available during start-up and checkout. The first two items listed are recommended for normal operation and maintenance:

Oscilloscope (scope) - Dual trace recommended
Volt-Ohmmeter (VOM) 20k ohm per volt sensitivity
minimum, 3 range: X1, X10, X100
RPM Measuring Device (0 to 10,000 RPM) Tach
Ammeter - 0 to 300 amps, adjustable range - clamp
on type

4.3 POWER-OFF CONTINUITY TEST

WARNING

VERIFY THAT THE MAIN THREE PHASE
AC POWER INPUT TO THE SYSTEM
EQUIPMENT IS DISCONNECTED OR
SWITCHED OFF.

Perform a point to point continuity test for all newly installed wiring and interconnection. Continuity is defined as 1/2 ohm or less.

4.4 NO LOAD-POWER TEST

WARNING

ELECTRICAL SHOCK CAN CAUSE PERSONAL INJURY OR LOSS OF LIFE. WHETHER THE AC SUPPLY IS GROUNDED OR NOT, HIGH VOLTAGES TO GROUND WILL BE PRESENT AT MANY POINTS THROUGHOUT THE DRIVE. CHARGED CAPACITORS REQUIRE ONE MINUTE DISCHARGE TIME.

No load testing is defined as the motor shaft disconnected from the driver machine or no working load on the machine.

WARNING

OPERATOR SHOULD NOT STAND ON GROUNDED SURFACES OR BE IN CONTACT WITH GROUND WHEN APPLYING TEST INSTRUMENTS TO TEST POINTS. CONVENTIONAL TEST INSTRUMENTS SHOULD NOT HAVE CHASSIS GROUNDED WHILE TESTS ARE BEING MADE. THUS THE CHASSIS CAN BE AT A HIGH VOLTAGE WITH RESPECT TO GROUND DURING TESTING. EXTREME CARE SHOULD BE TAKEN WHILE ATTEMPTING TO ADJUST, TROUBLESHOOT OR MAINTAIN THIS DRIVE SYSTEM.

- 4.4.1 Disconnect cables P1 from each Inverter phase module (Inverter phase modules cover must be removed) connection studs (three P1 cables). Make sure the disconnected cables are at least one-half inch away from any other conductive material and taped. Connect VOM (400vdc range) between P1(+) stud and P3(-) for monitoring capacitor discharge.

NOTE

DURING CHECKOUT, RECORD MEASUREMENTS AND SETTINGS FOR FUTURE REFERENCE.

- 4.4.2 Verify that the three phase a-c power input to the Inverter is of proper value as noted on the equipment data nameplate.
- 4.4.3 Place the "Speed Control" potentiometer to zero (fully counterclockwise). Verify that the "I.R. COMP" potentiometer is fully counterclockwise.

- 4.4.4 Move the test card to test socket B.
- 4.4.5 Apply three phase a-c input power to the Inverter Unit.
- 4.4.6 Check that the "POWER ON" indicator is illuminated and Check blower rotation (if supplied).
- 4.4.7 Check that the "INVERTER ON" and "RESET" (Fault) indicators are not illuminated (if supplied).
- 4.4.8 With the oscilloscope check that the following listed voltages are as indicated, using the Test Card test points.
- a. +20VDC $\pm 0.2V$
 - b. -20VDC $\pm 0.2V$
 - c. +5VDC $\pm 0.1V$
 - d. -5VDC $\pm 0.1V$
 - e. DFP +30 VDC approximately (unloaded) +20V with 5V ripple (loaded).
 - f. +10VDC (approximately) Voltage Feedback on "Read" with switch on position 18B.
 - g. No pulses or pulse trains on "Read" with test switch positions 1B through 12B selected.

NOTE

ONCE "START" IS OPERATED PULSES
CANNOT BE STOPPED OUT OF COMMU-
TATION FIRINGS CFSP OR CFSN (WITH
P1 DISCONNECTED).

- 4.4.9 Press the Inverter "START" pushbutton; "INVERTER ON" indicator illuminates (if supplied). "RESET" (Fault) indicator (if supplied) illuminates momentarily then stays out.
- 4.4.10 With the scope connected to "Read" and test switch on 19B slowly increase the "Speed Control" potentiometer until a +5.0VDC ± 0.05 is reached. The +5.0VDC measured corresponds to a 40HZ input for Group 1 Drivers and 80HZ for Group 2 Drivers (60 and 120hz base frequency systems). Note and record the Speed Control setting.
- 4.4.11 With the scope still connected to "Read" test point on the test card, select the test switch positions listed in the table below and verify the scope display that is indicated by the two wave forms as shown in Figures 1 and 2 in the Appendix, Section VIII.

NOTE

THE NOTED "CHOPS" INCREASE
PER HALF CYCLE WITH A DECREASE
OF THE SPEED CONTROL AND NO
"CHOPS" APPEAR ABOVE BASE
FREQUENCY.

Test Switch Position Versus Wave Form

TEST SWITCH POSITION	WAVE FORM
1B, 3B, 5B, 7B, 9B, 11B	Figure 1
2B, 4B, 6B, 8B, 10B, 12B	Figure 2

Same as above but C test socket for Parallel Phase Shifting (when supplied).

- 4.4.12 With the scope probe still connected to "Read" and test switch still on 12B slowly increase speed control until no "CHOPS" are present. While observing scope display, slowly decrease speed control and observe the increasing amount of "CHOPS" appearing in the wave form until zero on the speed control is reached (fully counterclockwise).

NOTE

THE NUMBER OF "CHOPS" IS CONTINUOUSLY BELOW 12 HZ AT A 2KC RATE.

WARNING

SCOPE CHASSIS MUST BE UNGROUNDED. SCOPE CHASSIS TO GROUND IS AT A HIGH POTENTIAL. DO NOT HAVE DRIVER COMMON CONNECTED WITH 1FFA SYNCHRONOUS.

- 4.4.13 With the scope verify that the following listed pulse trains are present on the output tabs of each of the six pulse transformer cards (2 cards per phase module) at the tabs as indicated below.

NOTE

IF NO OUTPUT OR AN IMPROPER OUTPUT IS OBSERVED, TEST THE OUTPUTS OF THE PROPER COMMUTATION CARD FOR THAT PHASE USING THE TEST CARD.

PHASE A MODULE - The right hand pulse transformer card is for commutation SCR's, the left is main inverter SCR's of each phase module.

Tabs AC and AG to commutation SCR's
Reference Figure 3 in Appendix in Section VIII.

Tabs AC and AG to main Inverter SCR's
Reference Figure 4.

Tabs BG, BC
Reference Figures 3 and 4.

Phases B and C pulse transformer cards output should be the same as above.

- 4.4.14 Press "INVERTER STOP/RESET" pushbutton. "INVERTER ON" indicator extinguishes.
- 4.4.15 Switch off or disconnect three phase input power to Inverter Unit: "POWER ON" indicator extinguishes. Check VOM to verify capacitors have discharged.
- 4.4.16 Re-connect P1 cables to each inverter phase module.
- 4.4.17 Replace the inverter assembly cover.
- 4.4.18 Set "Speed Control" potentiometer to zero (fully clockwise).

CAUTION

WHEN THE DRIVE HAS NOT BEEN OPERATED FOR 90 DAYS OR MORE, THE ELECTROLYTIC CAPACITORS IN THE PHASE MODULE MUST BE RE-FORMED. TO FORM THE CAPACITORS, CONNECT IN SERIES A 100 OHM, 50 WATT RESISTOR IN THE L1 CHOKE INPUT LINE AND APPLY POWER TO THE DRIVE FOR 30 MINUTES. DO NOT RUN THE INVERTER. REMOVE POWER AND REMOVE THE RESISTOR AND RECONNECT THE CABLES.

- 4.4.19 Apply three phase a-c input power to the Inverter Unit. Verify that the "POWER ON" indicator is illuminated.

- 4.4.20 Press the Inverter "START" pushbutton; "INVERTER ON" indicator illuminates (if supplied). "RESET" indicator (if supplied) should not be illuminated.
- 4.4.21 With the scope verify that the Filter signal and signals CCA, CCB and CCC on the Monitor card test points are as indicated in Figures 6 and 7 of the Appendix.
- 4.4.22 Slowly increase the "Speed Control" potentiometer until motor base speed is reached, using a hand tachometer to verify motor rpm.

4.5 NO LOAD SYSTEM ADJUSTMENTS

The No Load System Adjustments will verify or peak up the factory set adjustments to optimize total end to end system performance in the field under no load conditions. Critical load adjustments will follow in the next subsection 4.6.

- 4.5.1 Apply a-c input power to the Inverter drive system. Inverter "POWER ON" indicator illuminates.
- 4.5.2 Verify that the "Speed Control" is fully counterclockwise. Press Inverter "START" pushbutton; Inverter "ON" indicator illuminates (if supplied).
- 4.5.3 Using a hand tachometer or a frequency indicator, slowly increase the speed control until the drive is operating at 90% of base frequency.
- 4.5.4 With a VOM measuring the output voltage to the motor, adjust the "Volts/hz" potentiometer on the a-c regulator card so that the rectified average voltage is 85% of the rated RMS motor voltage. (Read approximately 200 VAC for 230V motor.)
- 4.5.5 To adjust the system for smooth motor starting and reversing the "Min Freq" potentiometer on the a-c regulator card is provided. Below the minimum frequency setting only voltage is reduced.
- 4.5.6 With clamp on ammeter attached to motor output terminals T1, T2 and T3 and the drive running at base speed, verify that readings are approximately equal.

4.6 SYSTEMS ADJUSTMENTS UNDER LOAD

The system load adjustments should be made with the motor at its normal "Hot Temperature" and the drive operating at 15% of base frequency under full working load.

NOTE

CURRENT LIMIT IS NORMALLY SET,
AT THE FACTORY, FOR 150% OF POWER
UNIT DATA NAMEPLATE RATING FOR
SINGLE MOTOR DRIVES.

4.6.1 Stability

The "Stability" potentiometer on the AC Regulator card adjusts the response and stability of the drive when operating in "current limit". With the scope connected to "READ" and the test switch at 19B position adjust the Stability pot in such a direction (while in current limit-acceleration) that the scope picture is as indicated in Figure 16 of the Appendix.

Slowly adjust the pot in the opposite direction until the scope picture is as indicated in Figure 15. If "I.R. COMP" or "SLIP COMP" are wired in they can inter-act with the system stability.

4.6.2 Time Up-Time Down

In reference to the "Time Up" and "Time Down", potentiometers on the reverse logic card, adjust the acceleration and deceleration rates respectively. The time for the drive to respond to a 10V step change in reference may be varied between 2.0SEC. and 32 SEC.

4.6.3 Voltage Boost

If a voltage boost function is provided the "Voltage Boost" potentiometer on the AC regulator card can be used to add a fixed voltage to the Inverter independent of frequency. An external voltage boost potentiometer may be provided.

4.6.4 I. R. Comp.

The "I.R. Comp." potentiometer on the reverse logic card may be adjusted to compensate for voltage loss due to motor resistance. If not used, turn full CCW.

4.6.5 Slip Comp.

If slip compensation is provided the "SLIP COMP" potentiometer on the reverse logic card may be adjusted to compensate for slip in motor speed due to loading.

SECTION V
MAINTENANCE

WARNING

ELECTRIC SHOCK CAN CAUSE PERSONAL INJURY OR LOSS OF LIFE. WHEN POWER OFF MAINTENANCE IS BEING PERFORMED, VERIFY ALL POWER TO THE DRIVE SYSTEM IS SWITCHED OFF OR DISCONNECTED. RECOMMEND POWER SWITCHES BE RED TAGGED DURING POWER OFF MAINTENANCE.

5.1 MECHANICAL INSPECTION

The mechanical maintenance required for the drive system is divided into two basic units; power unit and motor. The power unit's only mechanical maintenance is checking and changing the air filters before they become clogged.

Motor maintenance is covered by the motor instruction book supplied with the motor and should be followed in all cases.

5.2 ELECTRICAL INSPECTION

Power off (every six months): Check all electrical connections for tightness. Look for signs of poor connections or overheating (arcing, discoloration). Manually check cooling fan/blower for easy rotation.

5.3 SCR OR RECTIFIER REPLACEMENT PROCEDURE

In the event of an SCR or Rectifier cell failure the following steps are required for replacement of the press pak cell on the heatsink assembly.

If minimized down time is a critical factor, it is recommended that a complete Inverter phase module (one phase module consisting of four SCR's, two rectifiers and two pulse transformer cards mounted on the heatsink assembly) be an "on the shelf" spare.

5.3.1 Inverter Phase Module Assembly

- a. Disconnect plug CAA, CAB or CAC.
- b. Remove the four mounting nuts and washers from the insulated studs where cables P1, P3, M and N cables are connected to the phase module. Remove the cable terminals from the studs and slide the assembly forward until clear from the unit.
- c. Disconnect the SCR leads (4 sets, red and white twisted wire) from the stab-on terminals on the two pulse transformer cards (terminals AC, AG and BC, BG). Remove the insulation panel (red with the twopulse transformer cards) by removing the four teflon screws. Disconnect the four sets (two red wires each) of snubber leads from the heat-sink assembly stab-ons. Remove the four bolts (two on each outside end of the sheet metal). Disconnect the power cable leads on the heatsinks from the snubber circuitry and remove assembly.
- d. Remove the associated SCR leads cable from the cable clamp for the failed cell.
- e. Reference heatsink pictorial for parts location and identification.

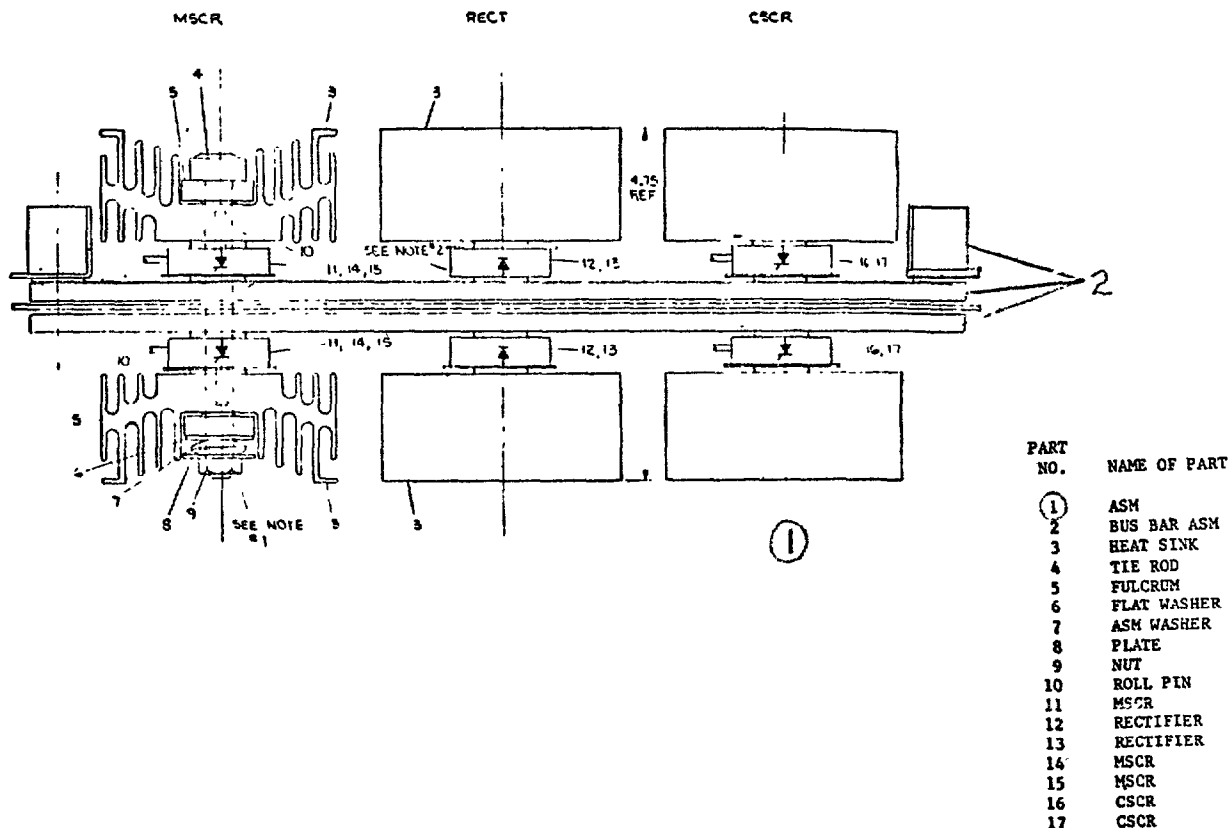

1. Place heatsink assembly with green tie rods (part 4) facing down and remove the nuts (two only) of the failed cell subassembly (part 9). This allows the tie rod to slip down to rest on the working surface.
2. Remove the failed cell and clean the heatsink surface with a soft cloth. Do not use any abrasive material to clean the heatsink or bus. Inspect the surface and carefully remove all high spots. If either heatsink or bus is more than 30% pitted at the semiconductor contact area, replace it.
3. Take the new replacement cell, twist the cell lead together, place white tubing over twisted cell leads and crimp on the female spade terminals and apply a small amount of "Burndy Penetrox A" (or equivalent joint compound) to the small hole on each side of the cell (with a dab on top) so that under pressure, the compound will cover only the raised center circular surface on each side.
4. Place new cell in the same orientation as the failed cell and place on the roll pin (part 10) of the heat-sink so the roll pin is in the center hole of the cell.
5. Place the two nuts (part 9) back on the tie rod (with parts 5, 6, 7 and 8 on the tie rod as indicated) and tighten each nut finger tight so the threads showing are approximately the same on both sides.
6. Check that both cell holes are still over the roll pins.
7. With the nuts finger tight, use a wrench and tighten each nut 1/6th of a turn (alternate between nuts) until the nuts have completed 1-5/6 turns each. This equals 45 inch-pounds on a torque wrench. Inspect the assembly to make sure that the heatsinks are aligned equally and parallel with each other and the center bus.

SECTION VI
TROUBLESHOOTING

6.1 GENERAL

The troubleshooting section has been divided into two basic tables and a paragraph on checking SCR's. Only trained and qualified electronics or electrical personnel should be allowed to troubleshoot this equipment, due to the dangers involved in having "POWER ON" measurements. It is recommended from a safety standpoint that the equipment be turned off, the test equipment connections be made, and the power applied for the measurement, and the equipment then be turned off again, prior to disconnecting the test equipment.

Fast, efficient troubleshooting of the drive system is based on a thorough knowledge of the theory of operation. During troubleshooting, when a card or subassembly is found or suspected of being bad, it is recommended that prior to replacing the card/sub-assembly, the inputs be checked for proper values. This will exclude the chance of further damage to the replacement item, due to causes beyond the suspected item.

6.1.1 Troubleshooting - Startup

Table 6-1 provides a one-to-one correlation with the startup sequence. In the left-hand column under indication will be the action/indication that failed. In the right-hand column under Check/Adjust/Replace are listed the tasks or measurements to be performed. When a step or action is completed and the malfunction still occurs, proceed to the next step. If the step locates the problem area, troubleshoot, isolate and correct the malfunction.

6.1.2 Troubleshooting - Driver/Power Conversion Modules

Table 6-2 provides a step by step troubleshooting procedure for the driver/power conversion modules.

WARNING

OPERATOR SHOULD NOT STAND
ON GROUNDED SURFACES OR BE
IN CONTACT WITH GROUND WHEN
APPLYING TEST INSTRUMENTS TO
TEST POINTS. CONVENTIONAL
TEST INSTRUMENTS SHOULD NOT
HAVE CHASSIS GROUNDED WHILE
TESTS ARE BEING MADE. THUS,
THE CHASSIS CAN BE AT A HIGH
VOLTAGE WITH RESPECT TO GROUND
DURING TESTING. EXTREME CARE
SHOULD BE TAKEN WHILE ATTEMPTING
TO ADJUST. TROUBLESHOOT OR MAINTAIN
ANY DRIVE SYSTEM DESCRIBED HEREIN.

6.1.3 Checking SCR's

Whenever an SCR is suspected of being at fault, use the following steps:

WARNING

ELECTRICAL SHOCK CAN CAUSE PERSONAL INJURY OR LOSS OF LIFE. WHETHER THE AC SUPPLY IS GROUNDED OR NOT, HIGH VOLTAGES TO GROUND WILL BE PRESENT AT MANY POINTS THROUGHOUT THE SYSTEM.

6.1.3.1 Checking SCR's when connected In-Line

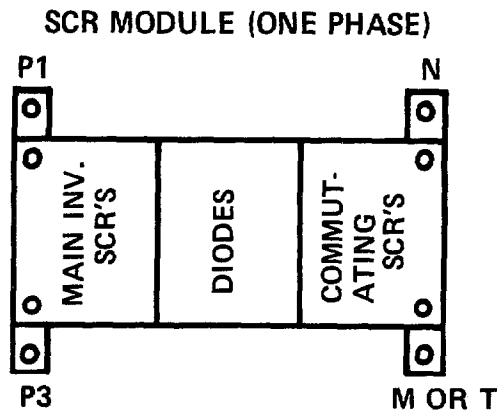

P1 TO M CHECKS POS INV SCR & DIODE
P1 TO N CHECKS POS COM SCR
P3 TO M CHECKS NEG INV SCR & DIODE
P3 TO N CHECKS NEG COM SCR

- a. SCR's can be checked without disconnecting leads
POWER OFF & wait 60 sec.

Normal Indication with OHM meter Pos. to first point

P1 to M - High Resistance
M to P1 - Low Resistance
P3 to M - Low Resistance
M to P3 - High Resistance
P1 to N - High
P3 to N - High

N to P1 - High
N to P3 - High

- b. If P1 or P3 to M reads low in both directions, remove one end of jumper on heatsink between the diode and SCR and measure resistance directly on heat sink.

6.1.3.2

Checking SCR Submodules

- a. Remove the suspected SCR submodule
- b. Using a multimeter selected to read ohms on the times-1K scale, check the forward and reverse resistance of each individual SCR cell. This is done by reading across heat sinks. (See conversion module elementary diagram.) Good or faulty SCR's will give the following typical readings:

<u>SCR Description</u>	<u>Forward Reading</u>	<u>Reverse Reading</u>
Good SCR	100K to Infinity	100K to Infinity
Shorted SCR	Zero	Zero
Inoperative SCR	1 to 2 K	100K to Infinity
Open SCR	100K to Infinity	100K to Infinity

- c. Since an open SCR will give about the same resistance reading as a good SCR, another method must be used to find this type of fault. It should be pointed out, however, that practically all cells fail by shorting and very few by opening. If an open SCR is suspected, or if it is desired to check the switching operation of an SCR, the following circuit should be used:

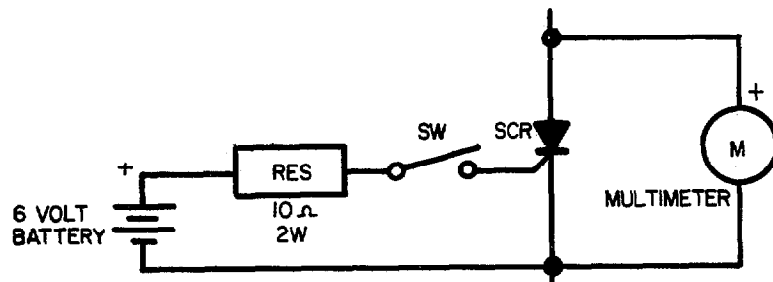

The multimeter is selected to read ohms on the 1K scale, and is connected to read the forward resistance of the SCR. When switch SW is closed, the forward resistance of a good SCR will change from a high value (100K to infinity) to a low value (1 to 10K). When the switch is opened, a good

SCR will revert to its high forward resistance or blocking state if the holding current source (multimeter battery) is momentarily removed. A faulty SCR will not switch, remaining in either an open or a conducting state.

- d. If any SCR;s are suspected of being faulty from the above resistance checks, the SCR conversion module should be removed from the case. After the SCR (cathode) and gate leads have been disconnected, recheck the forward and reverse resistances before replacing the SCR heat sink assembly. This should be done before the SCR is definitely classified as damaged or faulty, since a fault in another SCR or another part of the circuitry can produce a faulty reading from a good SCR before it is disconnected from the circuit. After an SCR is removed from the heatsink it may read open due to lack of pressure.

TABLE 6-1 STARTUP TROUBLESHOOTING

INDICATION	CHECK/ADJUST/REPLACE
<p>"POWER ON" indicator fails to illuminate. (4.4.6)</p>	<ol style="list-style-type: none"> 1. Check that the lamp is good 2. Check for three phase a-c input. 3. Check three input fuses for continuity (FUA1, 2 and 3).
<p>No voltages or improper voltages (4.4.8) on test card.</p>	<ol style="list-style-type: none"> 1. Check for 115VAC control transformer output (X2 to FX1). 2. Check fuse on control transformer. 3. Check Driver Transformer Assembly (behind Driver rack) outputs:
<p>"INVERTER ON" and "RESET" indicators fail to illuminate (4.4.9) – if supplied, or Inverter relays fail to actuate.</p>	<ol style="list-style-type: none"> 4. If card a-c input is correct but d-c output is incorrect, replace card under test. 1. Check that all thermal safety switches in the start circuit are closed. If thermal switch is found to be open, check for cause and correct. 2. Check that the IS relay is energized and operating properly, if not replace. 3. Check for proper operation of any auxiliary relays that may be in the start/stop circuit. 4. Check that the normally open (N.O.) contacts RX relay are closed (RX relay energized). 5. Check that "INVERTER ON" lamp is good.
<p>"INVERTER ON" indicator does not illuminate, but "RESET" indicator stays illuminated. (4.4.9) – if supplied Inverter fails to start.</p>	<ol style="list-style-type: none"> 1. Press "STOP/RESET", then "START" pushbuttons. If "RESET" indicator still remains illuminated check the following: <ol style="list-style-type: none"> a. Power supply (S) fuses b. Shorted SCR's c. Driver (Table 6-2)
<p>No pulses out of pulse transformer card(s) (4.4.13)</p>	<ol style="list-style-type: none"> 1. Shorted SCR gate lead. 2. Open circuit between driver and pulse trans. 3. No firing power 4. Defective pulse transformer card.
<p>High pulse approx. 15 volts (4.4.13)</p>	<ol style="list-style-type: none"> 1. Open gate lead on SCR.
<p>No signal or wrong connection of filter. (4.4.21)</p>	<ol style="list-style-type: none"> 1. Shut Inverter off immediately and check for open or reversed circuit signal on the driver from the filter assemblies.
<p>CCA, CCB, CCC low signals, no signal or missing pulses. (4.4.21)</p>	<ol style="list-style-type: none"> 1. Check for proper firing signals to SCR's of corresponding phase. 2. Check for commutation feedback continuity.
<p>Motor cannot reach top speed. (4.4.22)</p>	<ol style="list-style-type: none"> 1. Check max. speed pot. 2. Check base freq. jumper 3. Check driver (volts/hertz) 4. Check line voltage

TABLE 6-1 STARTUP TROUBLESHOOTING

INDICATION	CHECK/ADJUST/REPLACE
<p>Motor stops (4.4.22)</p>	<ol style="list-style-type: none"> 1. Check thermal switches if wired in start/stop circuit. 2. Momentary or complete loss of 115VAC 3. Motor over load, breaker, or fuses (if supplied) 4. Starter overload 5. "IOC" or "TRIP"
<p>Motor doesn't turn, just hums or smokes. (4.5.3)</p>	<ol style="list-style-type: none"> 1. Check for all three phases 2. Check for binding load 3. Check current limit setting
<p>Motor runs erratic or rough (4.5.3)</p>	<ol style="list-style-type: none"> 1. With clamp-on ammeter check for balanced output to motor. 2. Check that all SCR's are firing.
<p>Input fuse fails (4.5.3)</p>	<ol style="list-style-type: none"> 1. Check for power shorts 2. Shorted capacitors 3. Shorted SCR or diode 4. Check current feedbacks for continuity and loose connections. 5. Check pulse transformers for continuity and loose connections.
<p>Oil on bottom of case</p>	<p>Check capacitors</p> <p style="text-align: center;">WARNING</p> <p style="text-align: center;">CAPACITOR OIL MAY BE CAUSTIC; DO NOT COME IN CONTACT WITH SKIN.</p>
<p>Intermittent shut downs</p>	<ol style="list-style-type: none"> 1. Check for suppression networks on relays 2. Check for other "noise" sources. 3. Check SCR and Diode snubber network. 4. Check for proper grounding of all subassemblies and all commutation and snubber capacitor cases.
<p>"TRIP" indicator on monitor card illuminates</p>	<ol style="list-style-type: none"> 1. Check DC buss voltage level 2. Check max. speed setting 3. Check freq. trip jumper 4. Check for over voltage on regenerating
<p>"IOC" indicator on monitor card illuminates</p>	<ol style="list-style-type: none"> 1. Shorted output 2. Over heated SCR's 3. Fan fuse 4. Inverter operating outside of specification -- protective shut down 5. Shorted SCR or diode (continue checking for cause.) 6. Noise pick up -- check RELAY snubbers and other noise sources 7. Instantaneous current limit not working or too high -- Check synchronizer card, modulator card, current feedback. 8. Check SCR snubbers in Inverter modules.

TABLE 6-2 DRIVER TROUBLESHOOTING

INDICATION	CHECK/ADJUST/REPLACE
<p>Test card switch position /receptacle</p>	1A -5 to $+14$ vdc
	2A $+5$ to -14 vdc
	3A Output Oscillator (1FP) at 25hz (Fig. 17)
	4A Frequency Times DC Link (FXL) 0 to -14 volts.
	5A Frequency ref. (if used) 48 times fundamental (Fund.) freq. for base frequency ranges X1, X2 or X4 Respectively.
	6A Frequency divider (OFP/2) – same as 5A with phase shift (Fig. 18)
	7A SQ wave at fund. freq. lagging 1FFA by 1/3 period (Fig. 20)
	8A SQ wave at fund. freq. lagging 1FFA by 2/3 period (Fig. 20)
	9A Driving sig. for Phase A (Fig's 21, 23a and 23b)
	10A Driving sig. for Phase B (Fig's 22, 23a and 23b)
	11A Driving sig. for Phase C (Fig's 21, 22, 23a and 23b)
	12A Triangle wave (Fig. 24)
	13A Firing Train-OFT, pulse width approx. 7 micro- sec and approx. 30 micro-sec between pulses (Fig. 25)
	14A Start signal: $+5$ volts for stop ("1" state). 0 volts for start ("0" state).
	15A Minimum voltage SIG – normally in "1" state when running. Must be in "0" state for starting or stopping.
	16A Signals when Inverter can start for precondition- ing. In "1" state when stop is called for; in "0" state when start is called for.
	17A A pulse showing half the period of the "TRIP" frequency.
	18A In "0" state with Inverter stopped; in "1" state with Inverter running.
	19A In "1" state forward, in "0" state reverse.

TABLE 6-2 DRIVER TROUBLESHOOTING

INDICATION	CHECK/ADJUST/REPLACE
Test Socket B 1B through 12B	Firing signal (Fig's 1 and 2A, B and C and Fig. 6, 7 and 8).
14 through 16B	13B Normally zero – approx. +10V for regenerating current limit (CL); –10V for motoring CL. (Fig. 14)
	Current feedback, CSA, CSB and CSC (Fig's 9, 10, 11 and 12).
	17B (CLA) in phase component of current-positive for regenerating, negative for motoring. (Fig. 13).
	18B Voltage feedback – normally +10 to 11 volts D.C.
	19B Frequency voltage (FV), 0 to +14 vdc depending on "Speed Control" setting. (Fig's 15 and 16).
Monitor card test connections	
Filter	Reference Figures 5A and 5B
CCA, CCB and CCC	Reference Figures 6 and 7
1FFA	Reference Figures 1, 2A, 2B and 2C

SECTION VIII
SPARE PARTS RECOMMENDATION

7.1 GENERAL

A realistic "on hand" spares stock coupled with the Speed Variator low cost card exchange plan will lead to faster resolution of down time of the equipment in case of malfunction. On hand spare parts, avoid extended down time after the problem has been located. Time is not lost waiting for parts that must be ordered and shipped from the factory. The concept of easily removable (plug-in printed circuit boards is a fallacy if it only takes a few minutes to discover the defective assembly but hours to order and procure a replacement. Therefore, from the standpoint of keeping the equipment/machine operating with a minimum of down time, readily available on hand spares are a must. For further information on the Speed Variator Department Card Exchange Plan, contact your local General Electric Company Installation and Service Engineering District Office or Speed Variator Department in Erie, Pennsylvania.

7.2 RECOMMENDED SPARE ASSEMBLIES, SUBASSEMBLIES AND PRINTED CIRCUIT CARD/BOARDS

NOTE

WHEN ORDERING SPARE PARTS, BE SURE
TO GIVE COMPLETE PART NUMBER, AND
ASSEMBLY NAME TO INSURE FAST AND
EFFICIENT SERVICE.

The following is a list of recommended spare parts for an AF-3061 Inverter:

Assembly/Subassembly	Quantity
Inverter Phase Module	1
Pulse Transformer Card	1
Current Feedback Card	1
+20VDC Power Supply Card	1
+5VDC Power Supply Card	1
Isolator/Power Supply Card	1
AC Regulator Card	1
Reverse Logic Card	1
Drive Modulator Card	1
Divider Card	1
Synchronizer II Card	1
Drive Protection Card	1
Commutation Card	1
Fuses (each type)	2

SECTION VIII
DOCUMENTATION/DRAWINGS FURNISHED

8.1

GENERAL

The following types of documentation/drawings are normally supplied with your variable speed drive to aid in the installation and operation of your system.

8.1.1 Documentation

- a. AF-3061
- b. Special Control Devices Instructions/Bulletins (if applicable)

8.1.2 Drawings/Prints

- a. Elementary Diagrams-System and Assemblies
- b. Connection Diagrams-System and Assemblies
- c. Interconnection Diagrams-System and Assemblies

APPENDIX

This section contains the oscilloscope (scope) pictures of critical Inverter wave shapes and signals for use in conjunction with Sections IV and VI of the Instruction Manual. The scope displays are dependent upon the calibration, probe attenuation factor and settings of the scope being used.

TEST CARD – COMMUTATION FIRING SIGNAL (CFSP, CFSN) TP – 1B, PHASE A, POSITIVE SCR. SIMILAR PULSES CAN BE SEEN ON TEST POINTS 3B, 5B, 7B, 9B AND 11B WITH APPROPRIATE PHASE SHIFTS.

NOTE: A SINGLE FIRING PULSE FOLLOWS EVERY TRAIN OF FIRING PULSES FOR THE CORRESPONDING MAIN INVERTER SCR.

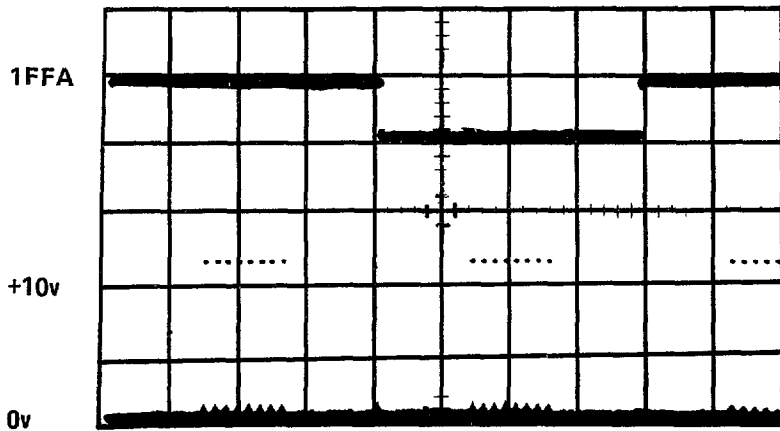

OPERATING FREQ. 40HZ

SCOPE SETTING:
5M SEC/CM
5 VOLTS/CM

USE 1FFA AS EXTERNAL
SYNC. SIGNAL.

FIGURE 1

TEST CARD – MAIN FIRING SIGNAL (IFSP)
TP – 2B, PHASE A, POSITIVE SCR. DC LINK DISCONNECTED.

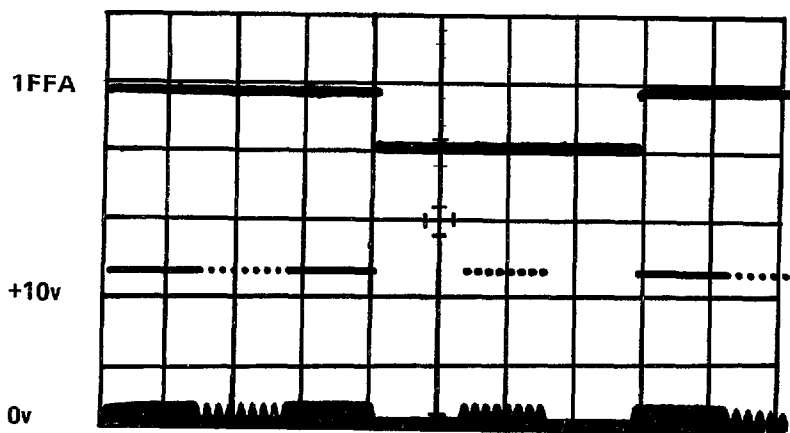

OPERATING FREQ. 40HZ

SCOPE SETTING:
5M SEC/CM
5 VOLTS/CM

USE 1FFA AS EXTERNAL
SYNC. SIGNAL.

FIGURE 2A

TEST CARD – MAIN INVERTER FIRING SIGNAL (IFSP)
 TP – 4B, PHASE A NEGATIVE SCR.

NOTE: IT IS 180 OUT OF PHASE WITH TEST POINT 2B.

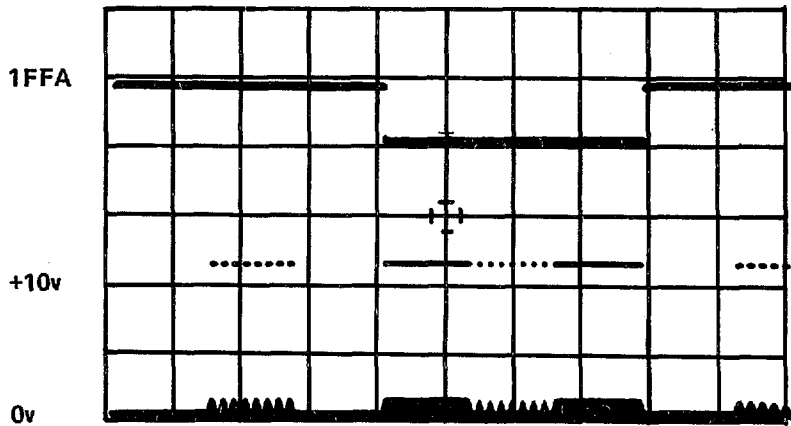

OPERATING FREQ. 40HZ

SCOPE SETTING:
 5M SEC/CM
 5 VOLTS/CM

USE 1FFA AS EXTERNAL
 SYNC. SIGNAL.

FIGURE 2B

TEST CARD – MAIN INVERTER FIRING SIGNAL (IFSP)
 TP – 6B, PHASE B POSITIVE SCR.

NOTE: IT LAGS PHASE A POSITIVE SCR BY 120 .
 TEST POINTS 8B, 10B AND 12B HAVE SIMILAR FIRING
 TRAINS WITH APPROPRIATE PHASE SHIFTS.

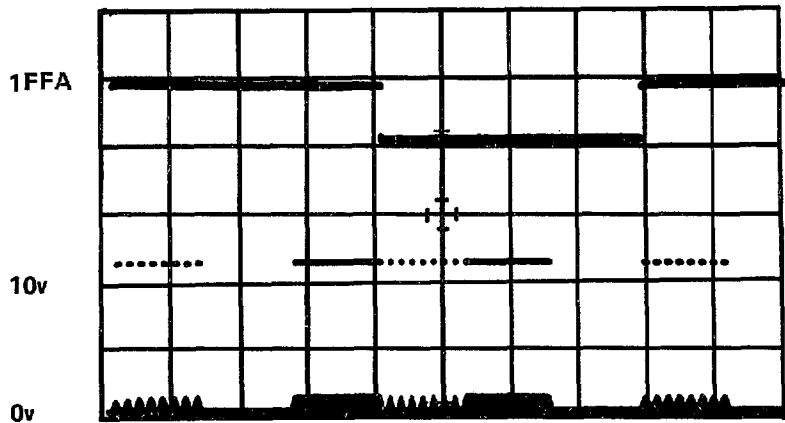

OPERATING FREQ. 40HZ

SCOPE SETTING:
 5M SEC/CM
 5 VOLTS/CM

USE 1FFA AS EXTERNAL
 SYNC. SIGNAL.

FIGURE 2C

OUTPUT OF PULSE TRANSFORMER COMM SIGNAL (CFSP) HEIGHT OF PULSE MAY VARY DEPENDING ON GATE CHARACTERISTICS.

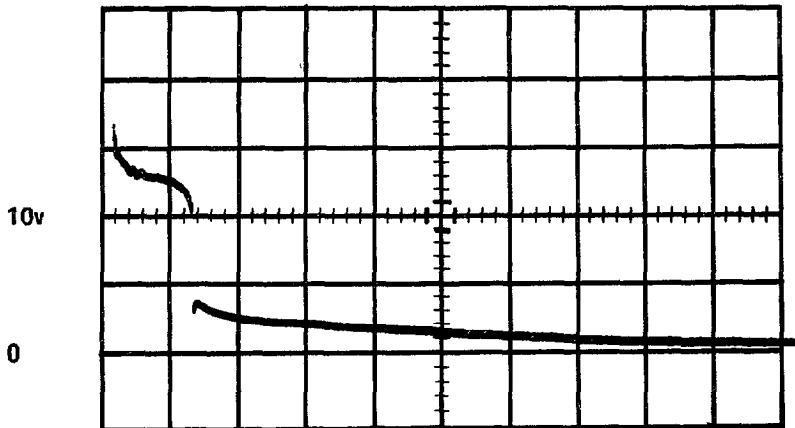

OPERATING FREQ. 40HZ

SCOPE SETTING:
10 MICRO-SEC/CM
5 VOLTS/CM

USE INTERNAL SYNC.
SIGNAL (SCOPE).

FIGURE 3

OUTPUT OF PULSE TRANSFORMER CARD (IFSP) HEIGHT OF PULSE MAY VARY DEPENDING ON GATE CHARACTERISTICS. INITIAL PULSE FOLLOWED BY PULSE TRAIN.

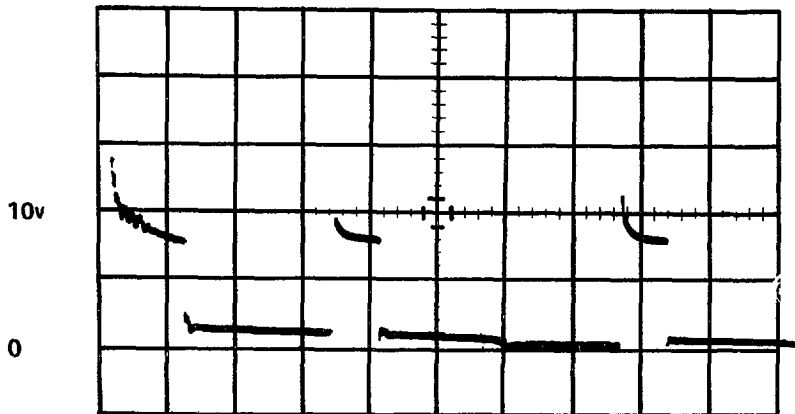

OPERATING FREQ. 40HZ

SCOPE SETTING:
10 MICRO-SEC/CM
5 VOLTS/CM

USE INTERNAL SYNC.
SIGNAL (SCOPE).

FIGURE 4

MONITOR CARD – FILTER SIGNAL – NO LOAD

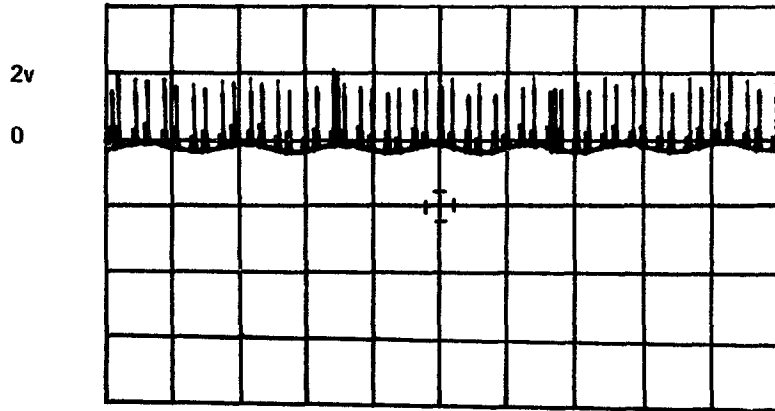

OPERATING FREQ. 25HZ

SCOPE SETTING.
2M SEC/CM
2 VOLTS/CM

USE 1FFA AS EXTERNAL
SYNC. SIGNAL

FIGURE 5A

MONITOR CARD – FILTER SIGNAL – FULL LOAD

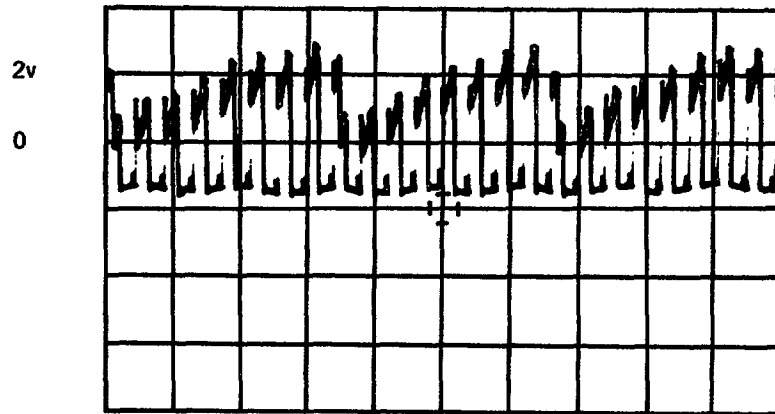

OPERATING FREQ. 25HZ

SCOPE SETTING:
2M SEC/CM
2 VOLTS/CM

USE 1FFA AS EXTERNAL
SYNC. SIGNAL.

FIGURE 5B

MONITOR CARD - 1 SINGLE CCA, CCB AND CCC SIGNAL. INVERTER RUNNING NO LOAD. THESE FOUR TRACES SHOW THE COMMUTATION STORY. CFSP - A COMMUTATION SCR IS FIRED. CCA - COMMUTATION CURRENT SWINGS THROUGH A HALF SINE WAVE COUNTERING THE INVERTER CURRENT AND TURNING OFF AN INVERTER SCR.

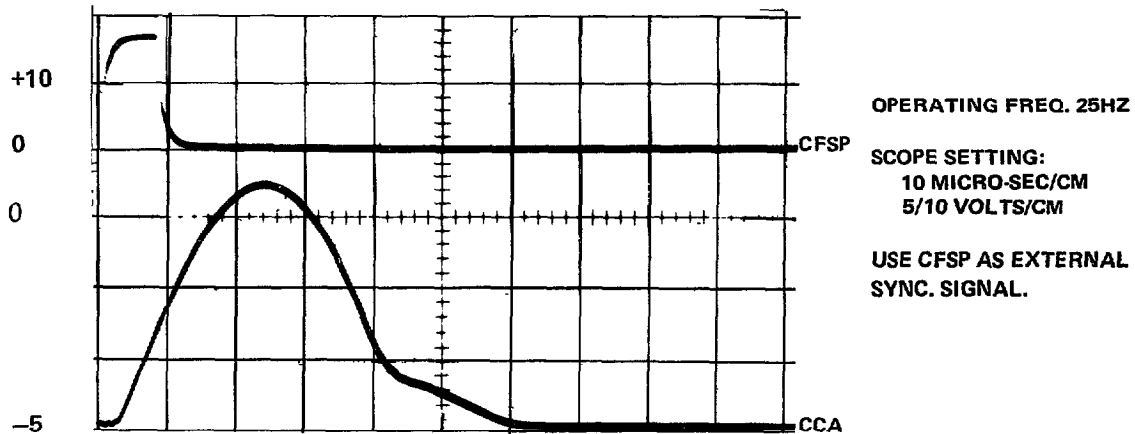

FIGURE 6 & 7

TEST CARD - INVERTER FIRING SIGNAL
 INITIAL PULSE (IFSN) - TP2B. IFSN - THE OPPOSITE SCR IS FIRED AS THE COMMUTATION CURRENT FEED-BACK SIGNAL IS DECREASING.
 FILTER - THE COMMUTATION CIRCUIT TAKES ON LOST ENERGY CAUSING A SURGE OF CURRENT IN THE FILTER.

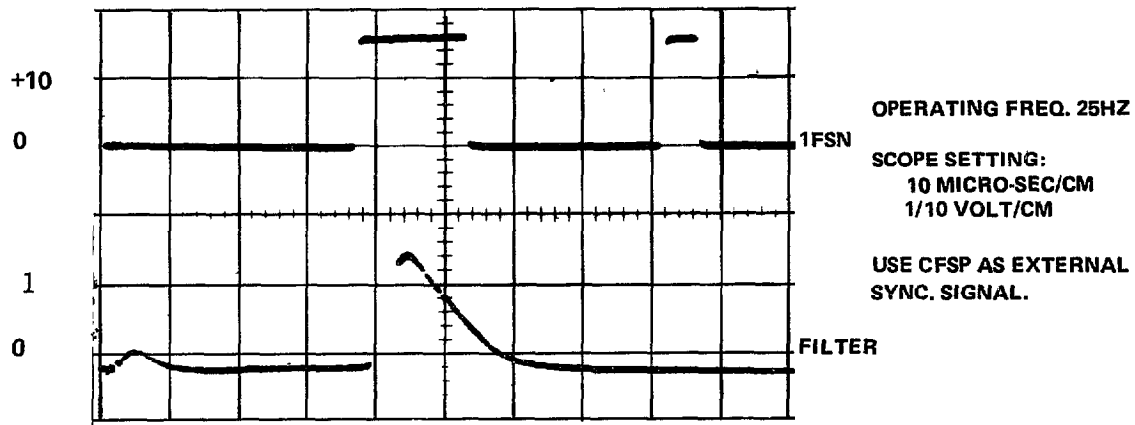
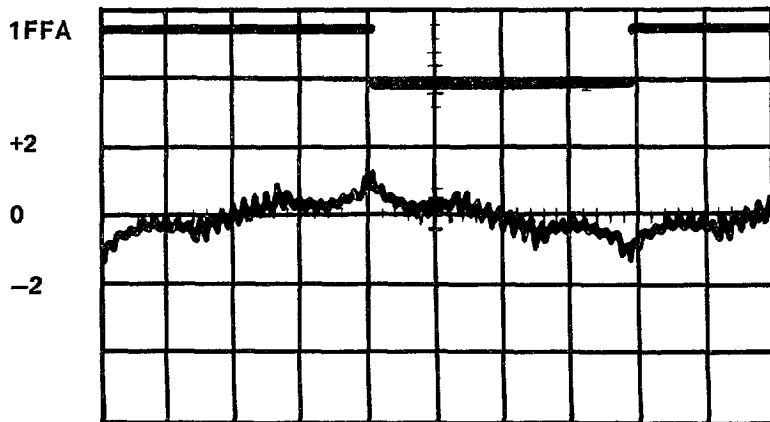

FIGURE 8

MONITOR CARD – 1FFA SIGNAL (TOP DISPLAY)
 TEST CARD – CSA SIGNAL TP14B (BOTTOM DISPLAY)
 MOTOR RUNNING – NO LOAD. NOTE PEAK LAGS 1FFA
 BY ABOUT 90 FROM POSITIVE CENTER.



OPERATING FREQ. 25HZ

SCOPE SETTING:
 TOP: 5M SEC/CM
 5 VOLTS/CM

BOTT: 5M SEC/CM
 2 VOLTS/CM

USE 1FFA AS EXTERNAL
 SYNC. SIGNAL.

FIGURE 9

MONITOR CARD – 1FFA SIGNAL (TOP DISPLAY)
 TEST CARD – CSA SIGNAL TP14B (BOTTOM DISPLAY)
 100% LOAD. NOTE PEAK CURRENT IS MORE TOWARD
 CENTER OF 1FFA SIGNAL.

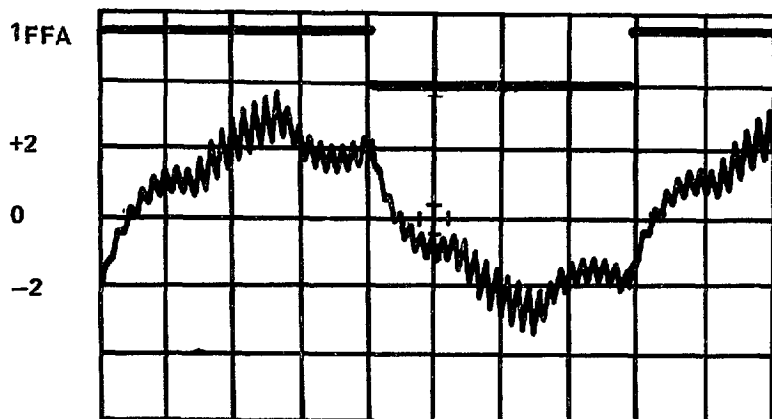

OPERATING FREQ. 25HZ

SCOPE SETTING:
 TOP: 5M SEC/CM
 5 VOLTS/CM

BOTT: 5M SEC/CM
 2 VOLTS/CM

USE 1FFA AS EXTERNAL
 SYNC. SIGNAL.

FIGURE 10

MONITOR CARD – 1FFA SIGNAL (TOP DISPLAY)
 TEST CARD – CSB SIGNAL TP15B (BOTTOM DISPLAY)
 100% LOAD. NOTE: SHIFTED 120 TO RIGHT OF CSA.

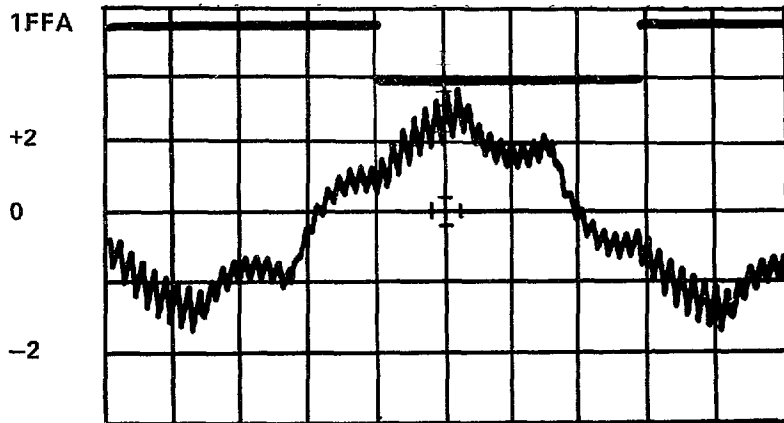

OPERATING FREQ. 25HZ

SCOPE SETTING:
 TOP: 5M SEC/CM
 5 VOLTS/CM

BOTT: 5M SEC/CM
 2 VOLTS/CM

USE 1FFA AS EXTERNAL
 SYNC. SIGNAL.

FIGURE 11

MONITOR CARD – 1FFA SIGNAL (TOP DISPLAY)
 TEST CARD – CSC SIGNAL TP16B (BOTTOM DISPLAY)
 100% LOAD. NOTE: SHIFTED 120 TO RIGHT OF CSB.

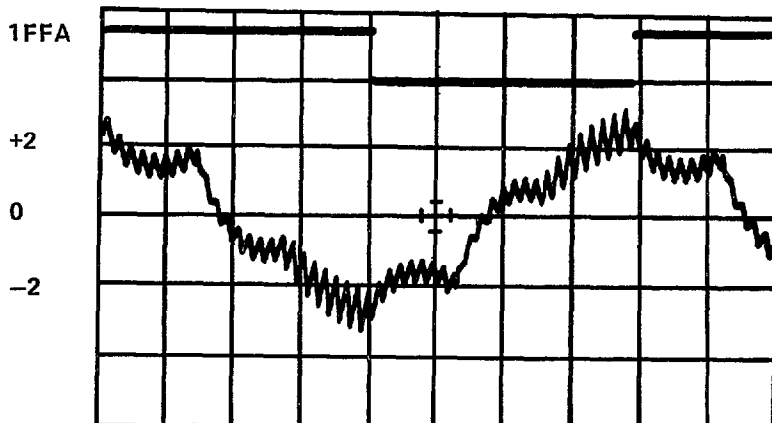

OPERATING FREQ. 25HZ

SCOPE SETTING:
 TOP: 5M SEC/CM
 5 VOLTS/CM

BOTT: 5M SEC/CM
 2 VOLTS/CM

USE 1FFA AS EXTERNAL
 SYNC. SIGNAL.

FIGURE 12

MONITOR CARD – 1FFA SIGNAL (TOP DISPLAY)
 TEST CARD – CLA AT 100% LOAD, TP17B. (BOTTOM DISPLAY)

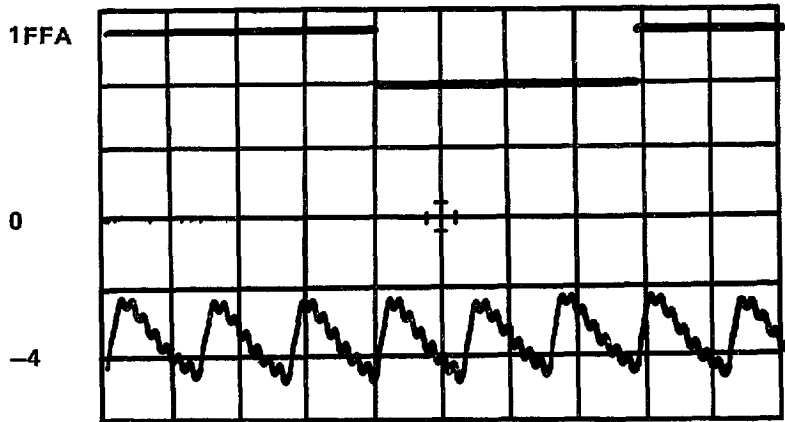

OPERATING FREQ. 25HZ

SCOPE SETTING:
 5M SEC/CM
 5 VOLTS/CM
 5M SEC/CM
 2 VOLT/CM

USE 1FFA AS EXTERNAL
 SYNC. SIGNAL.

FIGURE 13

TEST CARD – CURRENT LIMIT SIGNAL, TP13B, OPERATING IN CURRENT LIMIT. NEGATIVE PULSES REDUCE REFERENCE. POSITIVE PULSES (NOT SHOWN) INCREASE REFERENCE IF REGENERATING IN CURRENT LIMIT.

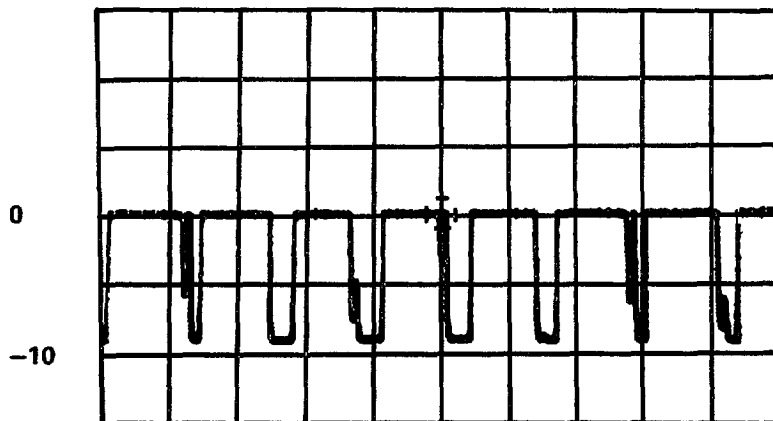

OPERATING FREQ. 25HZ

SCOPE SETTING:
 5M SEC/CM
 5 VOLTS/CM

USE 1FFA AS EXTERNAL
 SYNC. SIGNAL.

FIGURE 14

TEST CARD – CURRENT LIMIT STABLE TP19B.

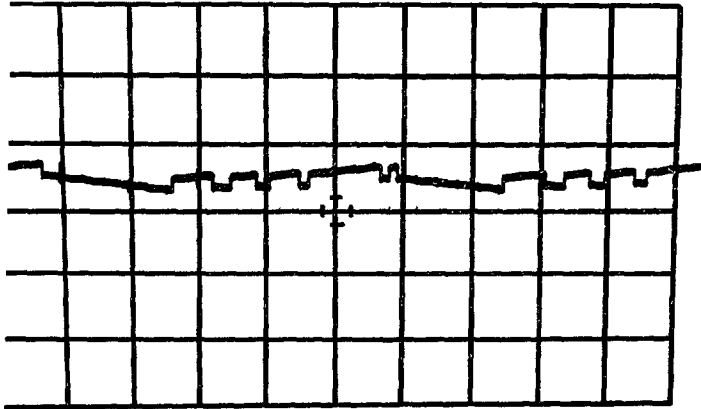

**OPERATING FREQ. (IN
CURRENT LIMIT)**

**SCOPE SETTING:
10M SEC/CM
.2 VOLT/CM**

**USE 1FFA AS EXTERNAL
SYNC. SIGNAL.**

FIGURE 15

TEST CARD – CURRENT LIMIT UNSTABLE TP19B.

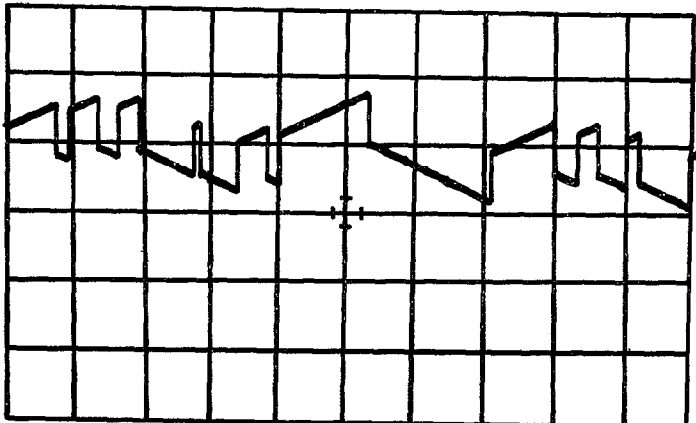

**OPERATING FREQ. (IN
CURRENT LIMIT)**

**SCOPE SETTING:
10M SEC/CM
.2 VOLT/CM**

**USE 1FFA AS EXTERNAL
SYNC. SIGNAL.**

FIGURE 16

TEST CARD - OUTPUT OSCILLATOR (1FP) TP3A.

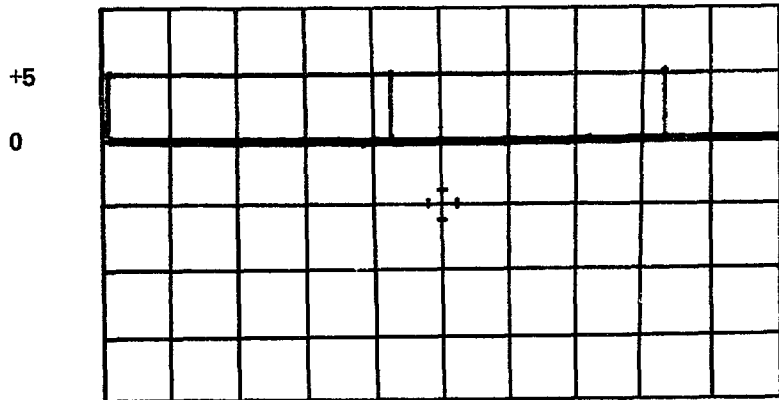

OPERATING FREQ. 25HZ

SCOPE SETTING:
.1M SEC/CM
5 VOLT/CM

USE INTERNAL SYNC.
SIGNAL (SCOPE).

FIGURE 17

TEST CARD - FREQUENCY DIVIDER (OFF/2) TP6A.
NOTE THAT IT IS HALF THE FREQUENCY OF 1FP.

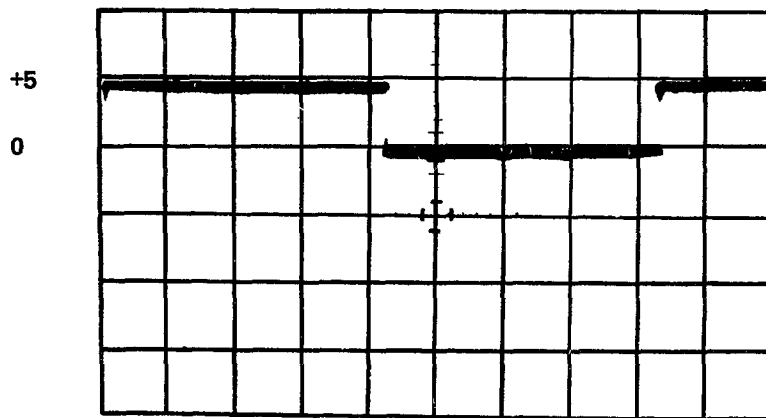

OPERATING FREQ. 25HZ

SCOPE SETTING:
.1M SEC/CM
5 VOLT/CM

USE INTERNAL SYNC.
SIGNAL (SCOPE).

FIGURE 18

**TEST CARD – FREQUENCY DIVIDER
(OFF6) NOTE THAT IT IS 6 TIMES THE FUNDAMENTAL
FREQUENCY.**

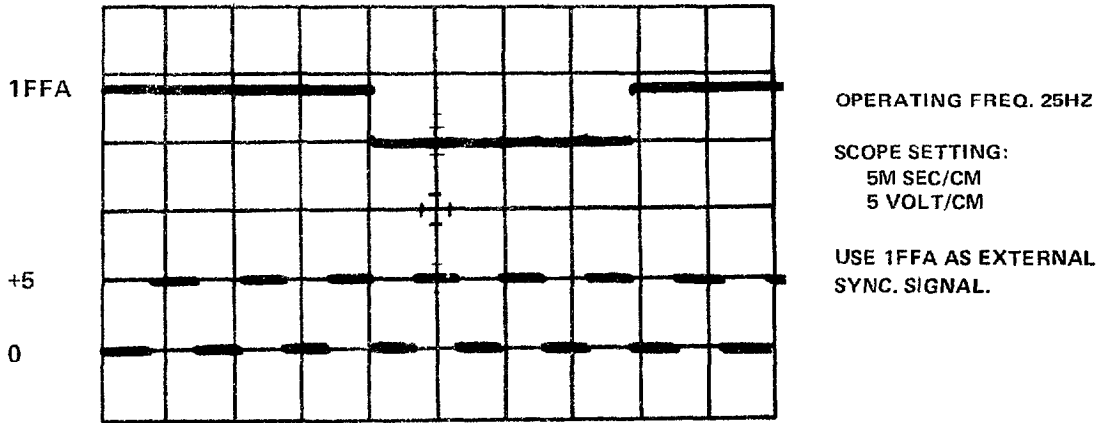

FIGURE 19

**TEST CARD – FUNDAMENTAL FREQUENCY PHASE Y.
(1FFY) TP7A (PHASE B – FORWARD)
(PHASE C – REVERSE)
NOTE THAT IT IS SHIFTED 120 TO THE RIGHT OF
1FFA. 1FFZ NOT SHOWN WOULD BE SHIFTED 120 FAR
TO THE LEFT (TP8A).**

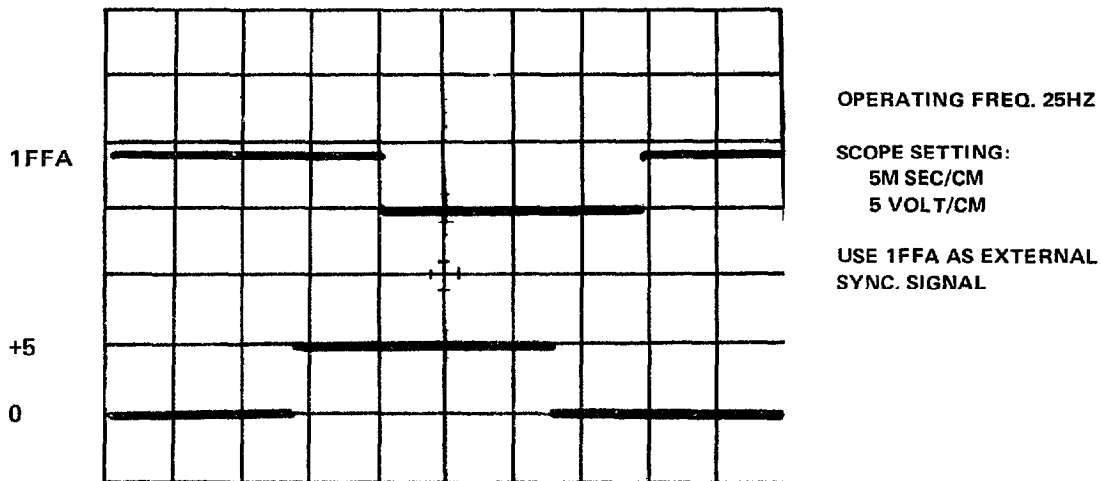
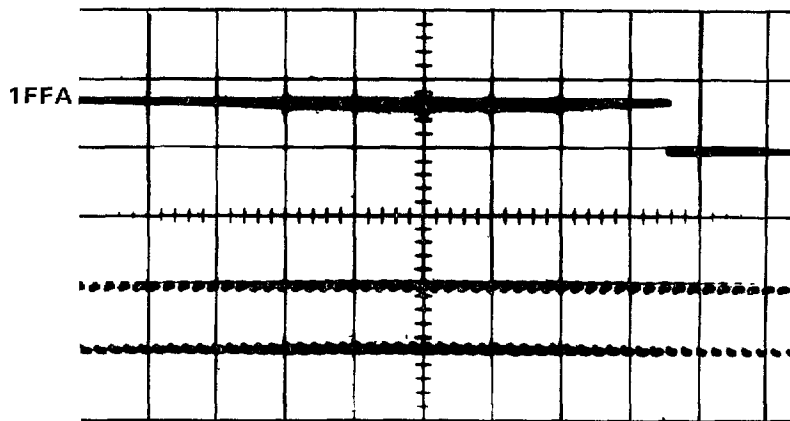

FIGURE 20

TEST CARD – OPMA @ FUNCTIONAL FREQUENCY BELOW 12HZ. NOTE: FULL CYCLE CHOPPING. THE ZERO IN FRONT OF THE PMA DESIGNATION INDICATES THAT IT IS 180 OUT OF PHASE WITH 1FFA, TP9A.



OPERATING FREQ. 10HZ

SCOPE SETTING:
5M SEC/CM
5 VOLT/CM

USE 1FFA AS EXTERNAL SYNC. SIGNAL.

FIGURE 21A

TEST CARD – OPMA @ FUNDAMENTAL FREQUENCY OF 25HZ. NOTE: 16 CHOPS PER CENTER 60. THE ZERO IN FRONT OF THE PMA DESIGNATION INDICATES THAT IT IS 180 OUT OF PHASE WITH THE 1FFA, TP9A.

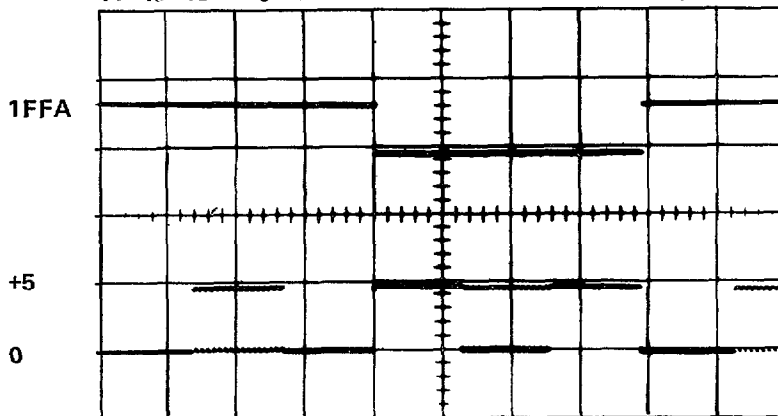

OPERATING FREQ. 25HZ

SCOPE SETTING:
5M SEC/CM
5 VOLT/CM

USE 1FFA AS EXTERNAL SYNC. SIGNAL.

FIGURE 21B

TEST CARD – OPMB @ FUNDAMENTAL FREQUENCY OF 25HZ. NOTE THAT OPMB LAGS OPMA BY 120 . THE OPMC SIGNAL (NOT SHOWN) WOULD LAG BY ANOTHER 120 . IN THE REVERSE MODE, THE RELATION OF OPMB AND OPMC WOULD BE SWITCHED, TP10A.

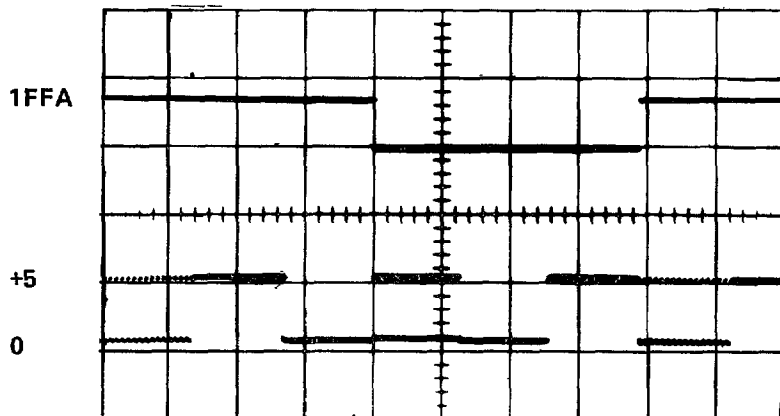

OPERATING FREQ. 25HZ

SCOPE SETTING:
5M SEC/CM
5 VOLT/CM

USE 1FFA AS EXTERNAL SYNC. SIGNAL.

FIGURE 22

TEST CARD - OPMA @ FUNDAMENTAL FREQUENCY OF 50HZ. NOTE: 6 CHOPS PER CENTER 60 , TP9A.

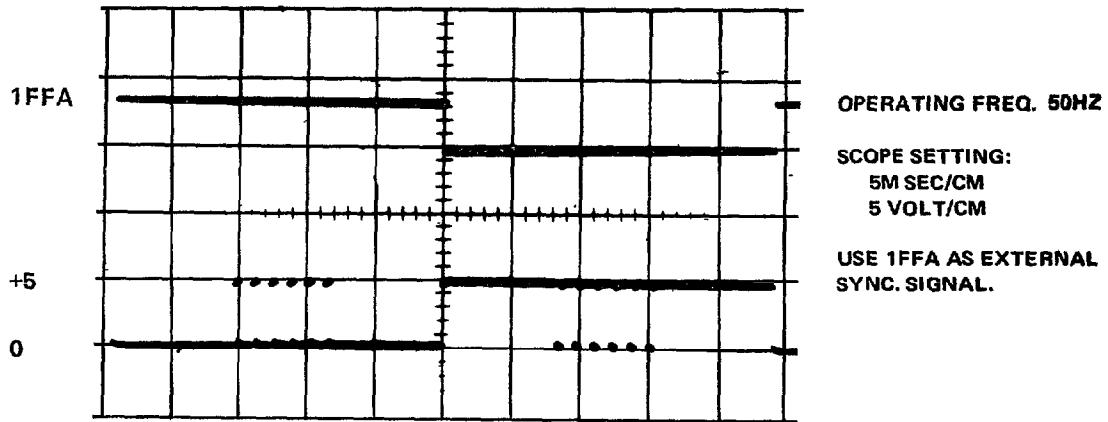

FIGURE 23a

TEST CARD - OPMA @ FUNDAMENTAL FREQUENCY OF 60HZ. NOTE: 2 CHOPS PER CENTER 60 , TP9A.

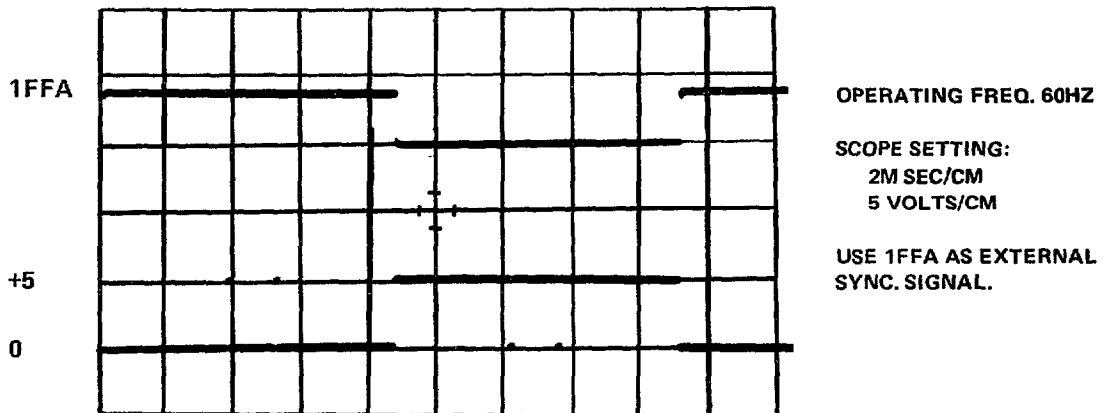
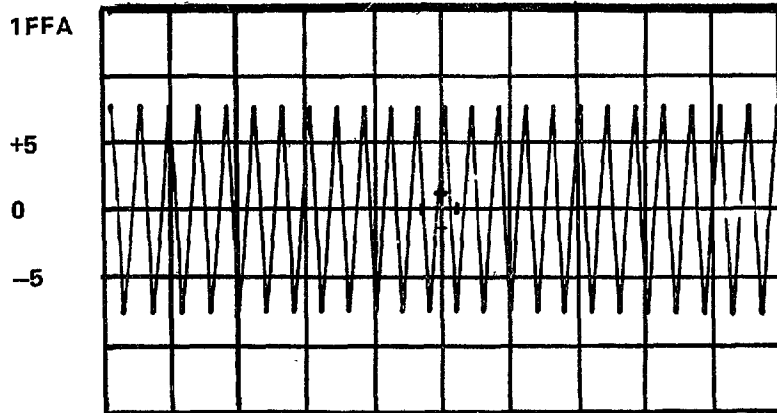

FIGURE 23b

TEST CARD – TRIANGLE WAVE FOR ONE HALF CYCLE
(180) OF FUNDAMENTAL FREQUENCY TP12A.



OPERATING FREQ. 25HZ

SCOPE SETTING:
2M SEC/CM
5 VOLT/CM

USE 1FFA AS EXTERNAL
SYNC. SIGNAL.

FIGURE 24

TEST CARD – FIRING OSCILLATOR (OFT) TP13A

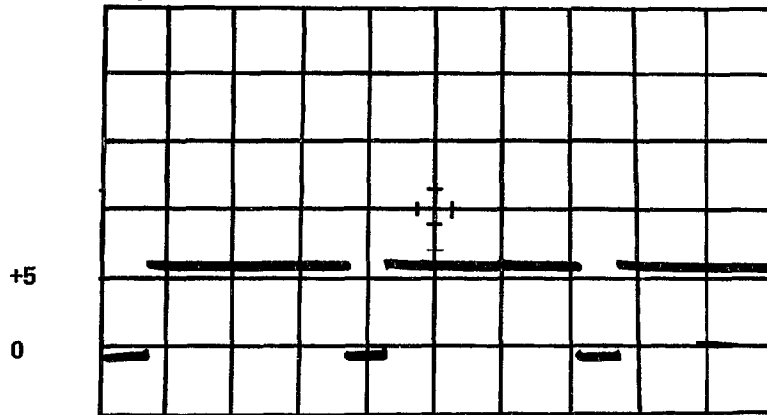

OPERATING FREQ. 25HZ

SCOPE SETTING:
10 MICRO-SEC/CM
5 VOLT/CM

USE INTERNAL SYNC.
SIGNAL (SCOPE).

FIGURE 25

CFSP, CCA, FILTER & 1FSN
FIRING RELATIONSHIP

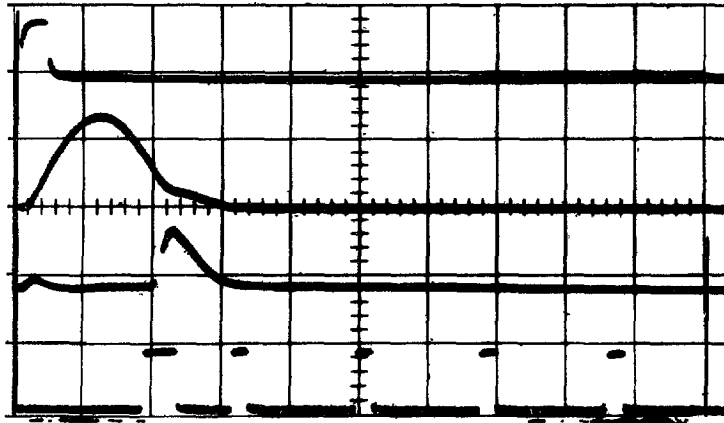

FIGURE 26

GENERAL ELECTRIC COMPANY — DIRECT CURRENT MOTOR & GENERATOR PRODUCTS DEPARTMENT
ERIE, PENNSYLVANIA 16531

GENERAL  **ELECTRIC**