



GE Industrial Systems

F35 Multiple Feeder Management Relay

UR Series Instruction Manual

F35 Revision: 4.4x

Manual P/N: 1601-0106-**J2** (GEK-112990A)

Copyright © 2005 GE Multilin



832761A1.CDR

GE Multilin

215 Anderson Avenue, Markham, Ontario
Canada L6E 1B3

Tel: (905) 294-6222 Fax: (905) 201-2098

Internet: <http://www.GEindustrial.com/multilin>



GE Multilin's Quality Management System is registered to ISO9001:2000
QMI # 005094
UL # A3775



ADDENDUM

This Addendum contains information that relates to the F35 Multiple Feeder Management Relay relay, version 4.4x. This addendum lists a number of information items that appear in the instruction manual GEK-112990A (revision **J2**) but are not included in the current F35 operations.

The following functions/items are not yet available with the current version of the F35 relay:

- N/A

Version 4.0x and higher releases of the F35 relay includes new hardware (CPU and CT/VT modules).

- The new CPU modules are specified with the following order codes: 9E, 9G, and 9H.
- The new CT/VT modules are specified with the following order codes: 8F, 8G, 8H, 8J.

The following table maps the relationship between the old CPU and CT/VT modules to the newer versions:

MODULE	OLD	NEW	DESCRIPTION
CPU	9A	9E	RS485 and RS485 (Modbus RTU, DNP)
	9C	9G	RS485 and 10Base-F (MMS/UCA2, Modbus TCP/IP, DNP)
	9D	9H	RS485 and Redundant 10Base-F (MMS/UCA2, Modbus TCP/IP, DNP)
CT/VT	8A	8F	Standard 4CT/4VT
	8B	8G	Sensitive Ground 4CT/4VT
	8C	8H	Standard 8CT
	8D	8J	Sensitive Ground 8CT/8VT

The new CT/VT modules can only be used with the new CPUs (9E, 9G, 9H), and the old CT/VT modules can only be used with the old CPU modules (9A, 9C, 9D). To prevent any hardware mismatches, the new CPU and CT/VT modules have blue labels and a warning sticker stating “**Attn.: Ensure CPU and DSP module label colors are the same!**”. In the event that there is a mismatch between the CPU and CT/VT module, the relay will not function and a **DSP ERROR** or **HARDWARE MISMATCH** error will be displayed.

All other input/output modules are compatible with the new hardware.

With respect to the firmware, firmware versions 4.0x and higher are only compatible with the new CPU and CT/VT modules. Previous versions of the firmware (3.4x and earlier) are only compatible with the older CPU and CT/VT modules.

TABLE OF CONTENTS

1. GETTING STARTED	1.1 IMPORTANT PROCEDURES
	1.1.1 CAUTIONS AND WARNINGS 1-1
	1.1.2 INSPECTION CHECKLIST 1-1
	1.2 UR OVERVIEW
	1.2.1 INTRODUCTION TO THE UR 1-2
	1.2.2 HARDWARE ARCHITECTURE 1-3
	1.2.3 SOFTWARE ARCHITECTURE 1-4
	1.2.4 IMPORTANT CONCEPTS 1-4
	1.3 ENERVISTA UR SETUP SOFTWARE
	1.3.1 PC REQUIREMENTS 1-5
	1.3.2 INSTALLATION 1-5
	1.3.3 CONNECTING ENERVISTA UR SETUP WITH THE F35 1-7
	1.4 UR HARDWARE
	1.4.1 MOUNTING AND WIRING 1-10
	1.4.2 COMMUNICATIONS 1-10
	1.4.3 FACEPLATE DISPLAY 1-10
	1.5 USING THE RELAY
	1.5.1 FACEPLATE KEYPAD 1-11
	1.5.2 MENU NAVIGATION 1-11
	1.5.3 MENU HIERARCHY 1-11
	1.5.4 RELAY ACTIVATION 1-12
	1.5.5 RELAY PASSWORDS 1-12
	1.5.6 FLEXLOGIC™ CUSTOMIZATION 1-12
	1.5.7 COMMISSIONING 1-13
2. PRODUCT DESCRIPTION	2.1 INTRODUCTION
	2.1.1 OVERVIEW 2-1
	2.1.2 ORDERING 2-2
	2.2 SPECIFICATIONS
	2.2.1 PROTECTION ELEMENTS 2-5
	2.2.2 USER-PROGRAMMABLE ELEMENTS 2-6
	2.2.3 MONITORING 2-7
	2.2.4 METERING 2-7
	2.2.5 INPUTS 2-8
	2.2.6 POWER SUPPLY 2-8
	2.2.7 OUTPUTS 2-9
	2.2.8 COMMUNICATIONS 2-10
	2.2.9 INTER-RELAY COMMUNICATIONS 2-10
	2.2.10 ENVIRONMENTAL 2-11
	2.2.11 TYPE TESTS 2-11
	2.2.12 PRODUCTION TESTS 2-11
	2.2.13 APPROVALS 2-11
	2.2.14 MAINTENANCE 2-11
3. HARDWARE	3.1 DESCRIPTION
	3.1.1 PANEL CUTOUT 3-1
	3.1.2 MODULE WITHDRAWAL AND INSERTION 3-4
	3.1.3 REAR TERMINAL LAYOUT 3-5
	3.2 WIRING
	3.2.1 TYPICAL WIRING 3-6
	3.2.2 DIELECTRIC STRENGTH 3-7
	3.2.3 CONTROL POWER 3-7
	3.2.4 CT/VT MODULES 3-8
	3.2.5 CONTACT INPUTS/OUTPUTS 3-10
	3.2.6 TRANSDUCER INPUTS/OUTPUTS 3-16
	3.2.7 RS232 FACEPLATE PORT 3-17
	3.2.8 CPU COMMUNICATION PORTS 3-18
	3.2.9 IRIG-B 3-20

TABLE OF CONTENTS

3.3 DIRECT I/O COMMUNICATIONS

3.3.1	DESCRIPTION	3-21
3.3.2	FIBER: LED AND ELED TRANSMITTERS	3-23
3.3.3	FIBER-LASER TRANSMITTERS	3-23
3.3.4	G.703 INTERFACE.....	3-24
3.3.5	RS422 INTERFACE	3-26
3.3.6	RS422 AND FIBER INTERFACE	3-29
3.3.7	G.703 AND FIBER INTERFACE	3-29
3.3.8	IEEE C37.94 INTERFACE.....	3-30

4. HUMAN INTERFACES

4.1 ENERVISTA UR SETUP SOFTWARE INTERFACE

4.1.1	INTRODUCTION	4-1
4.1.2	CREATING A SITE LIST	4-1
4.1.3	ENERVISTA UR SETUP SOFTWARE OVERVIEW.....	4-1
4.1.4	ENERVISTA UR SETUP SOFTWARE MAIN WINDOW	4-3

4.2 FACEPLATE INTERFACE

4.2.1	FACEPLATE	4-4
4.2.2	LED INDICATORS.....	4-5
4.2.3	DISPLAY	4-8
4.2.4	KEYPAD	4-8
4.2.5	MENUS	4-8
4.2.6	CHANGING SETTINGS	4-10

5. SETTINGS

5.1 OVERVIEW

5.1.1	SETTINGS MAIN MENU	5-1
5.1.2	INTRODUCTION TO ELEMENTS	5-4
5.1.3	INTRODUCTION TO AC SOURCES.....	5-5

5.2 PRODUCT SETUP

5.2.1	PASSWORD SECURITY	5-8
5.2.2	DISPLAY PROPERTIES	5-9
5.2.3	CLEAR RELAY RECORDS	5-11
5.2.4	COMMUNICATIONS	5-12
5.2.5	MODBUS USER MAP	5-21
5.2.6	REAL TIME CLOCK	5-21
5.2.7	FAULT REPORTS	5-22
5.2.8	OSCILLOGRAPHY	5-23
5.2.9	DATA LOGGER.....	5-25
5.2.10	DEMAND	5-26
5.2.11	USER-PROGRAMMABLE LEDS	5-27
5.2.12	USER-PROGRAMMABLE SELF TESTS	5-30
5.2.13	CONTROL PUSHBUTTONS	5-30
5.2.14	USER-PROGRAMMABLE PUSHBUTTONS.....	5-32
5.2.15	FLEX STATE PARAMETERS	5-33
5.2.16	USER-DEFINABLE DISPLAYS	5-34
5.2.17	DIRECT INPUTS/OUTPUTS	5-36
5.2.18	INSTALLATION	5-41

5.3 SYSTEM SETUP

5.3.1	AC INPUTS.....	5-42
5.3.2	POWER SYSTEM	5-43
5.3.3	SIGNAL SOURCES	5-44
5.3.4	FLEXCURVES™	5-46

5.4 FLEXLOGIC™

5.4.1	INTRODUCTION TO FLEXLOGIC™	5-53
5.4.2	FLEXLOGIC™ RULES	5-59
5.4.3	FLEXLOGIC™ EVALUATION	5-59
5.4.4	FLEXLOGIC™ EXAMPLE	5-60
5.4.5	FLEXLOGIC™ EQUATION EDITOR.....	5-64
5.4.6	FLEXLOGIC™ TIMERS	5-64
5.4.7	FLEXELEMENTS™	5-65
5.4.8	NON-VOLATILE LATCHES	5-69

TABLE OF CONTENTS

5.5 GROUPED ELEMENTS

5.5.1	OVERVIEW	5-70
5.5.2	SETTING GROUP	5-70
5.5.3	PHASE CURRENT	5-70
5.5.4	NEUTRAL CURRENT	5-78
5.5.5	GROUND CURRENT	5-80
5.5.6	VOLTAGE ELEMENTS	5-82

5.6 CONTROL ELEMENTS

5.6.1	OVERVIEW	5-87
5.6.2	SETTING GROUPS	5-87
5.6.3	SELECTOR SWITCH	5-88
5.6.4	UNDERFREQUENCY	5-93
5.6.5	AUTORECLOSE	5-94
5.6.6	DIGITAL ELEMENTS	5-100
5.6.7	DIGITAL COUNTERS	5-103
5.6.8	8-BIT SWITCHES	5-105
5.6.9	MONITORING ELEMENTS	5-106

5.7 INPUTS/OUTPUTS

5.7.1	CONTACT INPUTS	5-109
5.7.2	VIRTUAL INPUTS	5-111
5.7.3	CONTACT OUTPUTS	5-112
5.7.4	LATCHING OUTPUTS	5-112
5.7.5	VIRTUAL OUTPUTS	5-114
5.7.6	REMOTE DEVICES	5-115
5.7.7	REMOTE INPUTS	5-116
5.7.8	REMOTE OUTPUTS	5-117
5.7.9	RESETTING	5-118
5.7.10	DIRECT INPUTS/OUTPUTS	5-118

5.8 TRANSDUCER I/O

5.8.1	DCMA INPUTS	5-122
5.8.2	RTD INPUTS	5-123
5.8.3	DCMA OUTPUTS	5-123

5.9 TESTING

5.9.1	TEST MODE	5-127
5.9.2	FORCE CONTACT INPUTS	5-127
5.9.3	FORCE CONTACT OUTPUTS	5-128

6. ACTUAL VALUES

6.1 OVERVIEW

6.1.1	ACTUAL VALUES MAIN MENU	6-1
-------	-------------------------------	-----

6.2 STATUS

6.2.1	CONTACT INPUTS	6-3
6.2.2	VIRTUAL INPUTS	6-3
6.2.3	REMOTE INPUTS	6-3
6.2.4	CONTACT OUTPUTS	6-4
6.2.5	VIRTUAL OUTPUTS	6-4
6.2.6	AUTORECLOSE	6-4
6.2.7	REMOTE DEVICES	6-4
6.2.8	DIGITAL COUNTERS	6-5
6.2.9	SELECTOR SWITCHES	6-5
6.2.10	FLEX STATES	6-5
6.2.11	ETHERNET	6-6
6.2.12	DIRECT INPUTS	6-6
6.2.13	DIRECT DEVICES STATUS	6-7
6.2.14	EGD PROTOCOL STATUS	6-7

6.3 METERING

6.3.1	METERING CONVENTIONS	6-8
6.3.2	SOURCES	6-11
6.3.3	TRACKING FREQUENCY	6-15
6.3.4	FLEXELEMENTS™	6-15
6.3.5	TRANSDUCER I/O	6-16

TABLE OF CONTENTS

6.4 RECORDS

6.4.1	FAULT REPORTS	6-17
6.4.2	EVENT RECORDS	6-19
6.4.3	OSCILLOGRAPHY	6-19
6.4.4	DATA LOGGER	6-19
6.4.5	BREAKER MAINTENANCE	6-20

6.5 PRODUCT INFORMATION

6.5.1	MODEL INFORMATION	6-21
6.5.2	FIRMWARE REVISIONS	6-21

7. COMMANDS AND TARGETS

7.1 COMMANDS

7.1.1	COMMANDS MENU	7-1
7.1.2	VIRTUAL INPUTS	7-1
7.1.3	CLEAR RECORDS	7-1
7.1.4	SET DATE AND TIME	7-2
7.1.5	RELAY MAINTENANCE	7-2

7.2 TARGETS

7.2.1	TARGETS MENU	7-3
7.2.2	TARGET MESSAGES	7-3
7.2.3	RELAY SELF-TESTS	7-3

A. FLEXANALOG PARAMETERS

A.1 PARAMETER LIST

B. MODBUS COMMUNICATIONS

B.1 MODBUS RTU PROTOCOL

B.1.1	INTRODUCTION	B-1
B.1.2	PHYSICAL LAYER	B-1
B.1.3	DATA LINK LAYER	B-1
B.1.4	CRC-16 ALGORITHM	B-2

B.2 FUNCTION CODES

B.2.1	SUPPORTED FUNCTION CODES	B-3
B.2.2	READ ACTUAL VALUES OR SETTINGS (FUNCTION CODE 03/04H)	B-3
B.2.3	EXECUTE OPERATION (FUNCTION CODE 05H)	B-4
B.2.4	STORE SINGLE SETTING (FUNCTION CODE 06H)	B-4
B.2.5	STORE MULTIPLE SETTINGS (FUNCTION CODE 10H)	B-5
B.2.6	EXCEPTION RESPONSES	B-5

B.3 FILE TRANSFERS

B.3.1	OBTAINING RELAY FILES VIA MODBUS	B-6
B.3.2	MODBUS PASSWORD OPERATION	B-7

B.4 MEMORY MAPPING

B.4.1	MODBUS MEMORY MAP	B-8
B.4.2	DATA FORMATS	B-43

C. IEC 60870-5-104 COMMS.

C.1 IEC 60870-5-104 PROTOCOL

C.1.1	INTEROPERABILITY DOCUMENT	C-1
C.1.2	POINTS LIST	C-10

D. DNP COMMUNICATIONS

D.1 DNP PROTOCOL

D.1.1	DEVICE PROFILE DOCUMENT	D-1
D.1.2	IMPLEMENTATION TABLE	D-4

TABLE OF CONTENTS

D.2 DNP POINT LISTS

D.2.1	BINARY INPUTS.....	D-8
D.2.2	BINARY AND CONTROL RELAY OUTPUTS.....	D-14
D.2.3	COUNTERS.....	D-15
D.2.4	ANALOG INPUTS.....	D-16

E. MISCELLANEOUS

E.1 CHANGE NOTES

E.1.1	REVISION HISTORY.....	E-1
E.1.2	CHANGES TO THE MANUAL.....	E-1

E.2 ABBREVIATIONS

E.2.1	STANDARD ABBREVIATIONS.....	E-5
-------	-----------------------------	-----

E.3 WARRANTY

E.3.1	GE MULTILIN WARRANTY.....	E-8
-------	---------------------------	-----

INDEX

Please read this chapter to help guide you through the initial setup of your new relay.

1.1.1 CAUTIONS AND WARNINGS



Before attempting to install or use the relay, it is imperative that all **WARNINGS** and **CAUTIONS** in this manual are reviewed to help prevent personal injury, equipment damage, and/or downtime.

1.1.2 INSPECTION CHECKLIST

- Open the relay packaging and inspect the unit for physical damage.
- View the rear nameplate and verify that the correct model has been ordered.

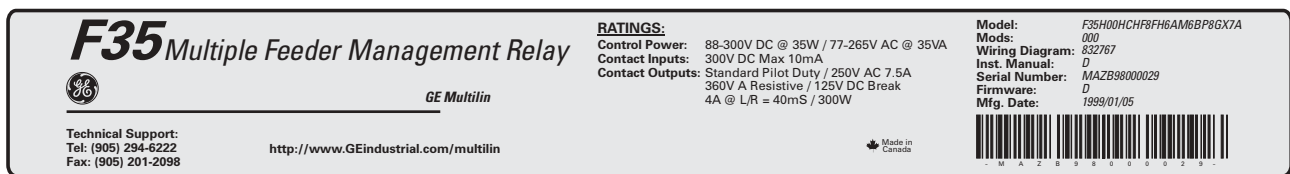

Figure 1-1: REAR NAMEPLATE (EXAMPLE)

- Ensure that the following items are included:
 - Instruction Manual
 - GE enerVista CD (includes the enerVista UR Setup software and manuals in PDF format)
 - mounting screws
 - registration card (attached as the last page of the manual)
- Fill out the registration form and return to GE Multilin (include the serial number located on the rear nameplate).
- For product information, instruction manual updates, and the latest software updates, please visit the GE Multilin website at <http://www.GEindustrial.com/multilin>.



If there is any noticeable physical damage, or any of the contents listed are missing, please contact GE Multilin immediately.

GE MULTILIN CONTACT INFORMATION AND CALL CENTER FOR PRODUCT SUPPORT:

GE Multilin
215 Anderson Avenue
Markham, Ontario
Canada L6E 1B3

TELEPHONE: (905) 294-6222, 1-800-547-8629 (North America only)

FAX: (905) 201-2098

E-MAIL: gmultilin@indsys.ge.com

HOME PAGE: <http://www.GEindustrial.com/multilin>

1.2.1 INTRODUCTION TO THE UR

Historically, substation protection, control, and metering functions were performed with electromechanical equipment. This first generation of equipment was gradually replaced by analog electronic equipment, most of which emulated the single-function approach of their electromechanical precursors. Both of these technologies required expensive cabling and auxiliary equipment to produce functioning systems.

Recently, digital electronic equipment has begun to provide protection, control, and metering functions. Initially, this equipment was either single function or had very limited multi-function capability, and did not significantly reduce the cabling and auxiliary equipment required. However, recent digital relays have become quite multi-functional, reducing cabling and auxiliaries significantly. These devices also transfer data to central control facilities and Human Machine Interfaces using electronic communications. The functions performed by these products have become so broad that many users now prefer the term IED (Intelligent Electronic Device).

It is obvious to station designers that the amount of cabling and auxiliary equipment installed in stations can be even further reduced, to 20% to 70% of the levels common in 1990, to achieve large cost reductions. This requires placing even more functions within the IEDs.

Users of power equipment are also interested in reducing cost by improving power quality and personnel productivity, and as always, in increasing system reliability and efficiency. These objectives are realized through software which is used to perform functions at both the station and supervisory levels. The use of these systems is growing rapidly.

High speed communications are required to meet the data transfer rates required by modern automatic control and monitoring systems. In the near future, very high speed communications will be required to perform protection signaling with a performance target response time for a command signal between two IEDs, from transmission to reception, of less than 5 milliseconds. This has been established by the Electric Power Research Institute, a collective body of many American and Canadian power utilities, in their IEC 61850 project. In late 1998, some European utilities began to show an interest in this ongoing initiative.

IEDs with the capabilities outlined above will also provide significantly more power system data than is presently available, enhance operations and maintenance, and permit the use of adaptive system configuration for protection and control systems. This new generation of equipment must also be easily incorporated into automation systems, at both the station and enterprise levels. The GE Multilin Universal Relay (UR) has been developed to meet these goals.

a) UR BASIC DESIGN

The UR is a digital-based device containing a central processing unit (CPU) that handles multiple types of input and output signals. The UR can communicate over a local area network (LAN) with an operator interface, a programming device, or another UR device.

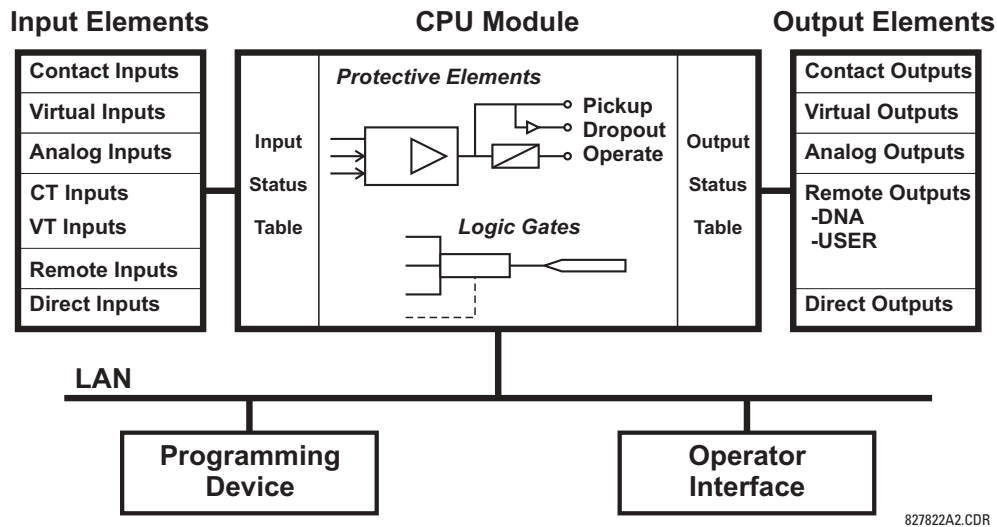

Figure 1-2: UR CONCEPT BLOCK DIAGRAM

The **CPU module** contains firmware that provides protection elements in the form of logic algorithms, as well as programmable logic gates, timers, and latches for control features.

Input elements accept a variety of analog or digital signals from the field. The UR isolates and converts these signals into logic signals used by the relay.

Output elements convert and isolate the logic signals generated by the relay into digital or analog signals that can be used to control field devices.

b) UR SIGNAL TYPES

The **contact inputs and outputs** are digital signals associated with connections to hard-wired contacts. Both 'wet' and 'dry' contacts are supported.

The **virtual inputs and outputs** are digital signals associated with UR-series internal logic signals. Virtual inputs include signals generated by the local user interface. The virtual outputs are outputs of FlexLogic™ equations used to customize the device. Virtual outputs can also serve as virtual inputs to FlexLogic™ equations.

The **analog inputs and outputs** are signals that are associated with transducers, such as Resistance Temperature Detectors (RTDs).

The **CT and VT inputs** refer to analog current transformer and voltage transformer signals used to monitor AC power lines. The UR-series relays support 1 A and 5 A CTs.

The **remote inputs and outputs** provide a means of sharing digital point state information between remote UR-series devices. The remote outputs interface to the remote inputs of other UR-series devices. Remote outputs are FlexLogic™ operands inserted into IEC 61850 GSSE messages and are of two assignment types: DNA standard functions and user-defined (UserSt) functions.

The **direct inputs and outputs** provide a means of sharing digital point states between a number of UR-series IEDs over a dedicated fiber (single or multimode), RS422, or G.703 interface. No switching equipment is required as the IEDs are connected directly in a ring or redundant (dual) ring configuration. This feature is optimized for speed and intended for pilot-aided schemes, distributed logic applications, or the extension of the input/output capabilities of a single relay chassis.

c) UR SCAN OPERATION

The UR-series devices operate in a cyclic scan fashion. The device reads the inputs into an input status table, solves the logic program (FlexLogic™ equation), and then sets each output to the appropriate state in an output status table. Any resulting task execution is priority interrupt-driven.

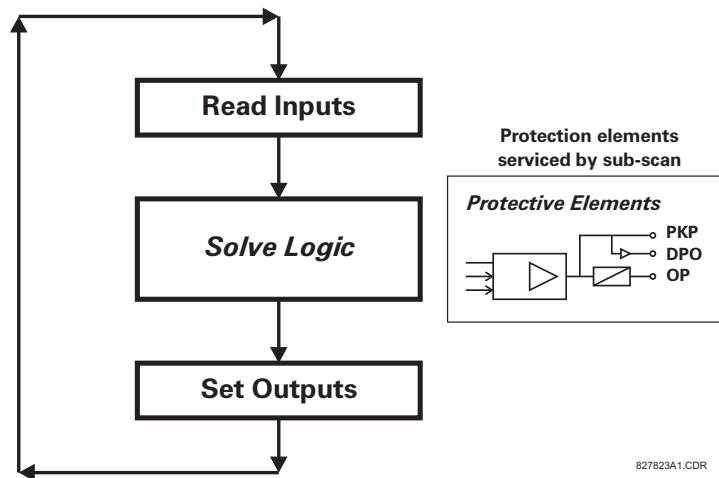

Figure 1-3: UR-SERIES SCAN OPERATION

1.2.3 SOFTWARE ARCHITECTURE

The firmware (software embedded in the relay) is designed in functional modules which can be installed in any relay as required. This is achieved with Object-Oriented Design and Programming (OOD/OOP) techniques.

Object-Oriented techniques involve the use of 'objects' and 'classes'. An 'object' is defined as "a logical entity that contains both data and code that manipulates that data". A 'class' is the generalized form of similar objects. By using this concept, one can create a Protection Class with the Protection Elements as objects of the class such as Time Overcurrent, Instantaneous Overcurrent, Current Differential, Undervoltage, Overvoltage, Underfrequency, and Distance. These objects represent completely self-contained software modules. The same object-class concept can be used for Metering, Input/Output Control, HMI, Communications, or any functional entity in the system.

Employing OOD/OOP in the software architecture of the Universal Relay achieves the same features as the hardware architecture: modularity, scalability, and flexibility. The application software for any Universal Relay (e.g. Feeder Protection, Transformer Protection, Distance Protection) is constructed by combining objects from the various functionality classes. This results in a 'common look and feel' across the entire family of UR-series platform-based applications.

1.2.4 IMPORTANT CONCEPTS

As described above, the architecture of the UR-series relays differ from previous devices. To achieve a general understanding of this device, some sections of Chapter 5 are quite helpful. The most important functions of the relay are contained in "elements". A description of the UR-series elements can be found in the *Introduction to Elements* section in Chapter 5. An example of a simple element, and some of the organization of this manual, can be found in the *Digital Elements* section. An explanation of the use of inputs from CTs and VTs is in the *Introduction to AC Sources* section in Chapter 5. A description of how digital signals are used and routed within the relay is contained in the *Introduction to FlexLogic™* section in Chapter 5.

The faceplate keypad and display or the enerVista UR Setup software interface can be used to communicate with the relay. The enerVista UR Setup software interface is the preferred method to edit settings and view actual values because the PC monitor can display more information in a simple comprehensible format.

The following minimum requirements must be met for the enerVista UR Setup software to properly operate on a PC.

- Pentium class or higher processor (Pentium II 300 MHz or higher recommended)
- Windows 95, 98, 98SE, ME, NT 4.0 (Service Pack 4 or higher), 2000, XP
- Internet Explorer 4.0 or higher
- 128 MB of RAM (256 MB recommended)
- 200 MB of available space on system drive and 200 MB of available space on installation drive
- Video capable of displaying 800 x 600 or higher in high-color mode (16-bit color)
- RS232 and/or Ethernet port for communications to the relay

The following qualified modems have been tested to be compliant with the F35 and the enerVista UR Setup software.

- US Robotics external 56K FaxModem 5686
- US Robotics external Sportster 56K X2
- PCTEL 2304WT V.92 MDC internal modem

1.3.2 INSTALLATION

After ensuring the minimum requirements for using enerVista UR Setup are met (see previous section), use the following procedure to install the enerVista UR Setup from the enclosed GE enerVista CD.

1. Insert the GE enerVista CD into your CD-ROM drive.
2. Click the **Install Now** button and follow the installation instructions to install the no-charge enerVista software.
3. When installation is complete, start the enerVista Launchpad application.
4. Click the **IED Setup** section of the **Launch Pad** window.



5. In the enerVista Launch Pad window, click the **Install Software** button and select the “F35 Multiple Feeder Management Relay” from the Install Software window as shown below. Select the “Web” option to ensure the most recent soft-

ware release, or select "CD" if you do not have a web connection, then click the **Check Now** button to list software items for the F35.



6. Select the F35 software program and release notes (if desired) from the list and click the **Download Now** button to obtain the installation program.



7. enerVista Launchpad will obtain the installation program from the Web or CD. Once the download is complete, double-click the installation program to install the enerVista UR Setup software.
8. Select the complete path, including the new directory name, where the enerVista UR Setup will be installed.
9. Click on **Next** to begin the installation. The files will be installed in the directory indicated and the installation program will automatically create icons and add enerVista UR Setup to the Windows start menu.

10. Click **Finish** to end the installation. The F35 device will be added to the list of installed IEDs in the enerVista Launchpad window, as shown below.



1.3.3 CONNECTING ENERVISTA UR SETUP WITH THE F35

This section is intended as a quick start guide to using the enerVista UR Setup software. Please refer to the enerVista UR Setup Help File and Chapter 4 of this manual for more information.

a) CONFIGURING AN ETHERNET CONNECTION

Before starting, verify that the Ethernet network cable is properly connected to the Ethernet port on the back of the relay. To setup the relay for Ethernet communications, it will be necessary to define a Site, then add the relay as a Device at that site.

1. Install and start the latest version of the enerVista UR Setup software (available from the GE enerVista CD or online from <http://www.GEindustrial.com/multilin> (see previous section for installation instructions).
2. Select the "UR" device from the enerVista Launchpad to start enerVista UR Setup.
3. Click the **Device Setup** button to open the Device Setup window, then click the **Add Site** button to define a new site.
4. Enter the desired site name in the "Site Name" field. If desired, a short description of site can also be entered along with the display order of devices defined for the site. Click the **OK** button when complete.
5. The new site will appear in the upper-left list in the enerVista UR Setup window. Click on the new site name and then click the **Device Setup** button to re-open the Device Setup window.
6. Click the **Add Device** button to define the new device.
7. Enter the desired name in the "Device Name" field and a description (optional) of the site.
8. Select "Ethernet" from the **Interface** drop-down list. This will display a number of interface parameters that must be entered for proper Ethernet functionality.
 - Enter the relay IP address (from **SETTINGS** ⇒ **PRODUCT SETUP** ⇒ **COMMUNICATIONS** ⇒ **NETWORK** ⇒ **IP ADDRESS**) in the "IP Address" field.
 - Enter the relay Modbus address (from the **PRODUCT SETUP** ⇒ **COMMUNICATIONS** ⇒ **MODBUS PROTOCOL** ⇒ **MODBUS SLAVE ADDRESS** setting) in the "Slave Address" field.
 - Enter the Modbus port address (from the **PRODUCT SETUP** ⇒ **COMMUNICATIONS** ⇒ **MODBUS PROTOCOL** ⇒ **MODBUS TCP PORT NUMBER** setting) in the "Modbus Port" field.
9. Click the **Read Order Code** button to connect to the F35 device and upload the order code. If an communications error occurs, ensure that the three enerVista UR Setup values entered in the previous step correspond to the relay setting values.

10. Click **OK** when the relay order code has been received. The new device will be added to the Site List window (or Online window) located in the top left corner of the main enerVista UR Setup window.

The Site Device has now been configured for Ethernet communications. Proceed to Section c) below to begin communications.

b) CONFIGURING AN RS232 CONNECTION

Before starting, verify that the RS232 serial cable is properly connected to the RS232 port on the front panel of the relay.

1. Install and start the latest version of the enerVista UR Setup software (available from the GE enerVista CD or online from <http://www.GEindustrial.com/multilin>).
2. Select the **Device Setup** button to open the Device Setup window and click the **Add Site** button to define a new site.
3. Enter the desired site name in the “Site Name” field. If desired, a short description of site can also be entered along with the display order of devices defined for the site. Click the **OK** button when complete.
4. The new site will appear in the upper-left list in the enerVista UR Setup window. Click on the new site name and then click the **Device Setup** button to re-open the Device Setup window.
5. Click the **Add Device** button to define the new device.
6. Enter the desired name in the “Device Name” field and a description (optional) of the site.
7. Select “Serial” from the **Interface** drop-down list. This will display a number of interface parameters that must be entered for proper serial communications.
 - Enter the relay slave address and COM port values (from the **SETTINGS** ⇒ **PRODUCT SETUP** ⇒ ⚙ **COMMUNICATIONS** ⇒ ⚙ **SERIAL PORTS** menu) in the “Slave Address” and “COM Port” fields.
 - Enter the physical communications parameters (baud rate and parity settings) in their respective fields.
8. Click the **Read Order Code** button to connect to the F35 device and upload the order code. If an communications error occurs, ensure that the enerVista UR Setup serial communications values entered in the previous step correspond to the relay setting values.
9. Click “OK” when the relay order code has been received. The new device will be added to the Site List window (or Online window) located in the top left corner of the main enerVista UR Setup window.

The Site Device has now been configured for RS232 communications. Proceed to Section c) Connecting to the Relay below to begin communications.

c) CONNECTING TO THE RELAY

1. Open the Display Properties window through the Site List tree as shown below:

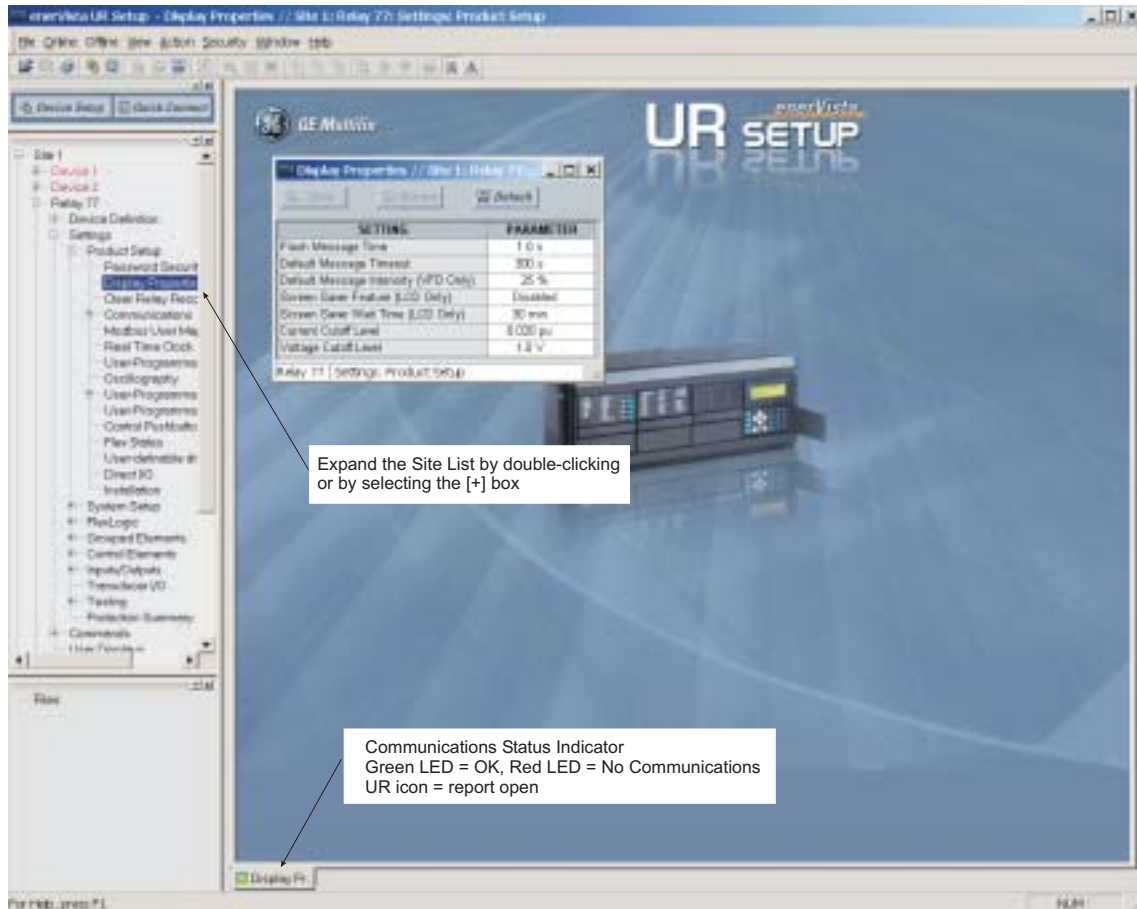

842743A1.CDR

2. The Display Properties window will open with a status indicator on the lower left of the enerVista UR Setup window.
3. If the status indicator is red, verify that the Ethernet network cable is properly connected to the Ethernet port on the back of the relay and that the relay has been properly setup for communications (steps A and B earlier).
If a relay icon appears in place of the status indicator, than a report (such as an oscillography or event record) is open. Close the report to re-display the green status indicator.
4. The Display Properties settings can now be edited, printed, or changed according to user specifications.



Refer to Chapter 4 in this manual and the enerVista UR Setup Help File for more information about the using the enerVista UR Setup software interface.

NOTE

1.4.1 MOUNTING AND WIRING

Please refer to Chapter 3: Hardware for detailed mounting and wiring instructions. Review all **WARNINGS** and **CAUTIONS** carefully.

1.4.2 COMMUNICATIONS

The enerVista UR Setup software communicates to the relay via the faceplate RS232 port or the rear panel RS485 / Ethernet ports. To communicate via the faceplate RS232 port, a standard “straight-through” serial cable is used. The DB-9 male end is connected to the relay and the DB-9 or DB-25 female end is connected to the PC COM1 or COM2 port as described in the CPU Communications Ports section of Chapter 3.

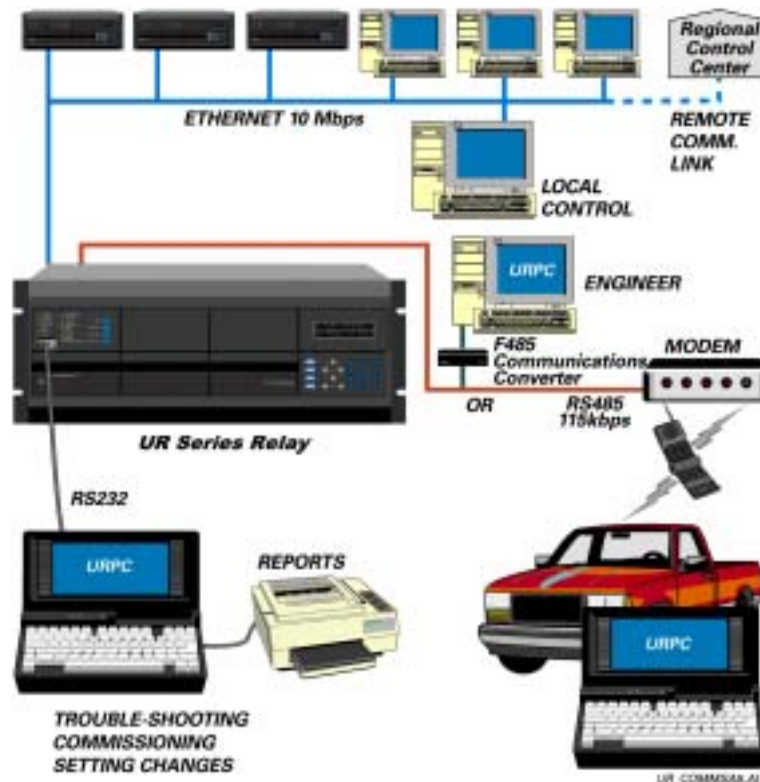

Figure 1-4: RELAY COMMUNICATIONS OPTIONS

To communicate through the F35 rear RS485 port from a PC RS232 port, the GE Multilin RS232/RS485 converter box is required. This device (catalog number F485) connects to the computer using a “straight-through” serial cable. A shielded twisted-pair (20, 22, or 24 AWG) connects the F485 converter to the F35 rear communications port. The converter terminals (+, –, GND) are connected to the F35 communication module (+, –, COM) terminals. Refer to the *CPU Communications Ports* section in Chapter 3 for option details. The line should be terminated with an R-C network (i.e. 120 Ω , 1 nF) as described in the Chapter 3.

1.4.3 FACEPLATE DISPLAY

All messages are displayed on a 2 × 20 character vacuum fluorescent display to make them visible under poor lighting conditions. An optional liquid crystal display (LCD) is also available. Messages are displayed in English and do not require the aid of an instruction manual for deciphering. While the keypad and display are not actively being used, the display will default to defined messages. Any high priority event driven message will automatically override the default message and appear on the display.

1.5.1 FACEPLATE KEYPAD

Display messages are organized into ‘pages’ under the following headings: Actual Values, Settings, Commands, and Targets. The **MENU** key navigates through these pages. Each heading page is broken down further into logical subgroups.

The **MESSAGE** keys navigate through the subgroups. The **VALUE** keys scroll increment or decrement numerical setting values when in programming mode. These keys also scroll through alphanumeric values in the text edit mode. Alternatively, values may also be entered with the numeric keypad.

The **ENTER** key initiates and advance to the next character in text edit mode or enters a decimal point. The **HELP** key may be pressed at any time for context sensitive help messages. The **ENTER** key stores altered setting values.

1.5.2 MENU NAVIGATION

Press the **MENU** key to select the desired header display page (top-level menu). The header title appears momentarily followed by a header display page menu item. Each press of the **MENU** key advances through the main heading pages as illustrated below.

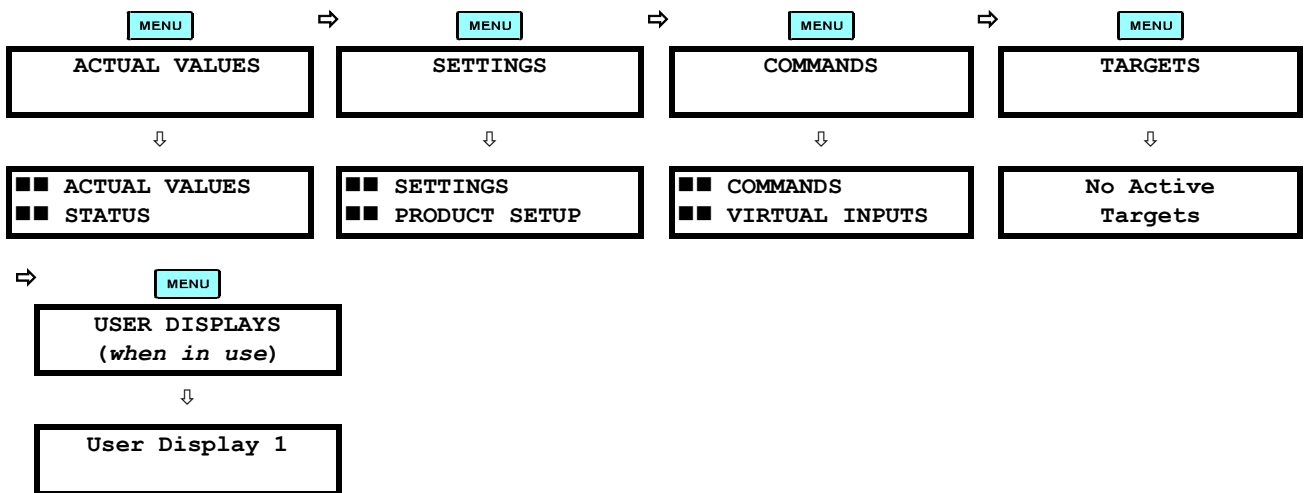

1.5.3 MENU HIERARCHY

The setting and actual value messages are arranged hierarchically. The header display pages are indicated by double scroll bar characters (■■), while sub-header pages are indicated by single scroll bar characters (■). The header display pages represent the highest level of the hierarchy and the sub-header display pages fall below this level. The MESSAGE **MESSAGE** and **MESSAGE** keys move within a group of headers, sub-headers, setting values, or actual values. Continually pressing the MESSAGE **MESSAGE** key from a header display displays specific information for the header category. Conversely, continually pressing the **MESSAGE** key from a setting value or actual value display returns to the header display.

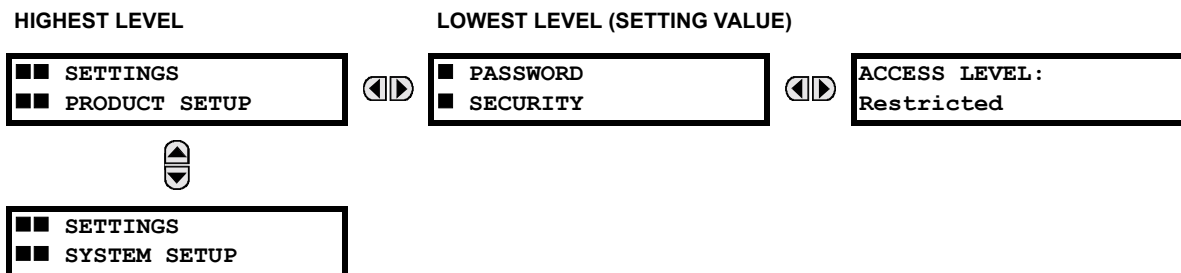

1.5.4 RELAY ACTIVATION

The relay is defaulted to the “Not Programmed” state when it leaves the factory. This safeguards against the installation of a relay whose settings have not been entered. When powered up successfully, the Trouble LED will be on and the In Service LED off. The relay in the “Not Programmed” state will block signaling of any output relay. These conditions will remain until the relay is explicitly put in the “Programmed” state.

Select the menu message **SETTINGS** ⇨ **PRODUCT SETUP** ⇨ **INSTALLATION** ⇨ **RELAY SETTINGS**

```
RELAY SETTINGS:
Not Programmed
```

To put the relay in the “Programmed” state, press either of the **▲** VALUE **▼** keys once and then press **ENTER**. The faceplate Trouble LED will turn off and the In Service LED will turn on. The settings for the relay can be programmed manually (refer to Chapter 5) via the faceplate keypad or remotely (refer to the enerVista UR Setup Help file) via the enerVista UR Setup software interface.

1.5.5 RELAY PASSWORDS

It is recommended that passwords be set up for each security level and assigned to specific personnel. There are two user password security access levels, COMMAND and SETTING:

1. COMMAND

The COMMAND access level restricts the user from making any settings changes, but allows the user to perform the following operations:

- change state of virtual inputs
- clear event records
- clear oscillography records
- operate user-programmable pushbuttons

2. SETTING

The SETTING access level allows the user to make any changes to any of the setting values.



Refer to the *Changing Settings* section in Chapter 4 for complete instructions on setting up security level passwords.

1.5.6 FLEXLOGIC™ CUSTOMIZATION

FlexLogic™ equation editing is required for setting up user-defined logic for customizing the relay operations. See the *Flex-Logic™* section in Chapter 5 for additional details.

Templated tables for charting all the required settings before entering them via the keypad are available from the GE Multilin website at <http://www.GEindustrial.com/multilin>.

The F35 requires a minimum amount of maintenance when it is commissioned into service. The F35 is a microprocessor-based relay and its characteristics do not change over time. As such no further functional tests are required.

Furthermore the F35 performs a number of ongoing self-tests and takes the necessary action in case of any major errors (see the *Relay Self-Test* section in Chapter 7 for details). However, it is recommended that maintenance on the F35 be scheduled with other system maintenance. This maintenance may involve the following.

In-service maintenance:

1. Visual verification of the analog values integrity such as voltage and current (in comparison to other devices on the corresponding system).
2. Visual verification of active alarms, relay display messages, and LED indications.
3. LED test.
4. Visual inspection for any damage, corrosion, dust, or loose wires.
5. Event recorder file download with further events analysis.

Out-of-service maintenance:

1. Check wiring connections for firmness.
2. Analog values (currents, voltages, RTDs, analog inputs) injection test and metering accuracy verification. Calibrated test equipment is required.
3. Protection elements setpoints verification (analog values injection or visual verification of setting file entries against relay settings schedule).
4. Contact inputs and outputs verification. This test can be conducted by direct change of state forcing or as part of the system functional testing.
5. Visual inspection for any damage, corrosion, or dust.
6. Event recorder file download with further events analysis.
7. LED Test and pushbutton continuity check.

Unscheduled maintenance such as during a disturbance causing system interruption:

1. View the event recorder and oscillography or fault report for correct operation of inputs, outputs, and elements.

If it is concluded that the relay or one of its modules is of concern, contact GE Multilin or one of its representatives for prompt service.

2.1.1 OVERVIEW

The F35 Multiple Feeder Management Relay is a microprocessor based relay designed for the protection of up to 5 feeders with busbar voltage measurement or up to 6 feeders without busbar voltage.

Overcurrent and undervoltage protection, breaker recloser, underfrequency, fault diagnostics, and RTU functions are provided. The F35 provides phase, neutral/ground, instantaneous and time overcurrent protection. The time overcurrent function provides multiple curve shapes or FlexCurve™ for optimum co-ordination.

Voltage, current, and power metering is built into the relay as a standard feature. Current parameters are available as total waveform RMS magnitude, or as fundamental frequency only RMS magnitude and angle (phasor). Voltage harmonics and THD metering are also included with the relay.

Diagnostic features include a sequence of records capable of storing 1024 time-tagged events. The internal clock used for time-tagging can be synchronized with an IRIG-B signal or via the SNTP protocol over the Ethernet port. This precise time stamping allows the sequence of events to be determined throughout the system. Events can also be programmed (via FlexLogic™ equations) to trigger oscillography data capture which may be set to record the measured parameters before and after the event for viewing on a personal computer (PC). These tools significantly reduce troubleshooting time and simplify report generation in the event of a system fault.

A faceplate RS232 port may be used to connect to a PC for the programming of settings and the monitoring of actual values. A variety of communications modules are available. Two rear RS485 ports allow independent access by operating and engineering staff. All serial ports use the Modbus® RTU protocol. The RS485 ports may be connected to system computers with baud rates up to 115.2 kbps. The RS232 port has a fixed baud rate of 19.2 kbps. Optional communications modules include a 10BaseF Ethernet interface which can be used to provide fast, reliable communications in noisy environments. Another option provides two 10BaseF fiber optic ports for redundancy. The Ethernet port supports IEC 61850, Modbus®/TCP, and TFTP protocols, and allows access to the relay via any standard web browser (F35 web pages). The IEC 60870-5-104 protocol is supported on the Ethernet port. DNP 3.0 and IEC 60870-5-104 cannot be enabled at the same time.

The F35 IEDs use flash memory technology which allows field upgrading as new features are added. The following Single Line Diagram illustrates the relay functionality using ANSI (American National Standards Institute) device numbers.

Table 2-1: ANSI DEVICE NUMBERS AND FUNCTIONS

DEVICE NUMBER	FUNCTION	DEVICE NUMBER	FUNCTION
27P	Phase Undervoltage	51P (up to 6)	Phase Time Overcurrent
27X	Auxiliary Undervoltage	52	AC Circuit Breaker
50G (up to 12)	Ground Instantaneous Overcurrent	59N	Neutral Overvoltage
50N (up to 12)	Neutral Instantaneous Overcurrent	59X	Auxiliary Overvoltage
50P (up to 12)	Phase Instantaneous Overcurrent	79 (up to 6)	Autoreclose
51G (up to 6)	Ground Time Overcurrent	81 (up to 6)	Underfrequency
51N (up to 6)	Neutral Time Overcurrent		

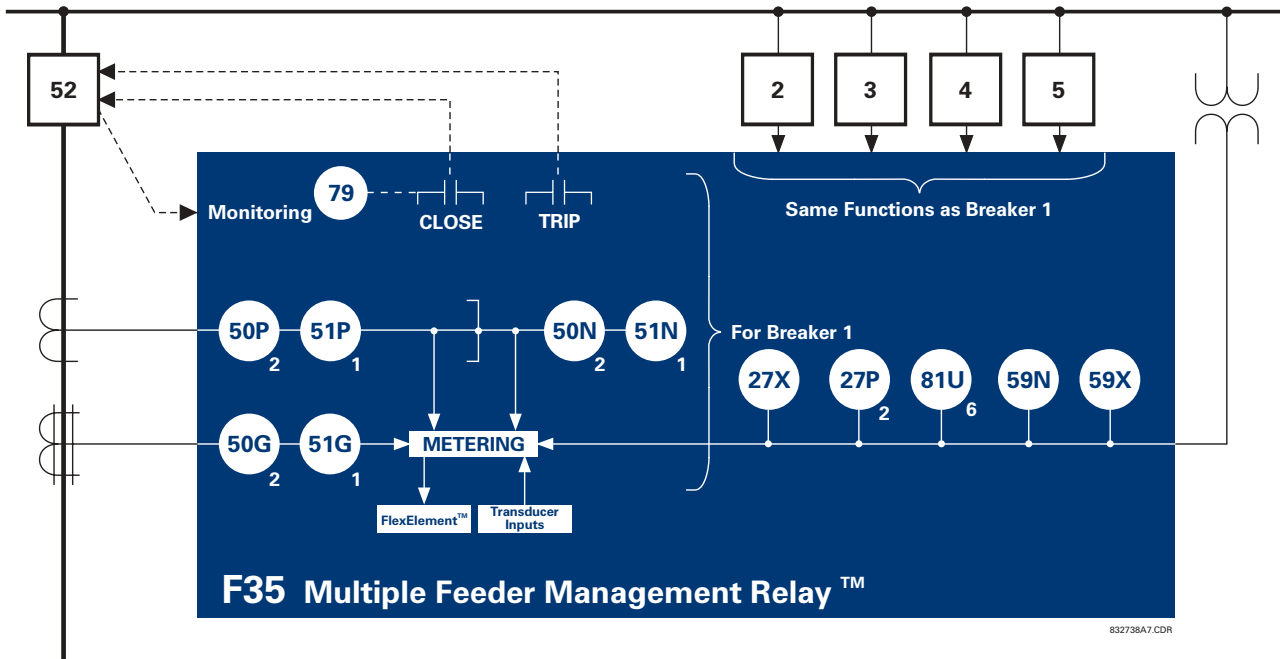

Figure 2–1: SINGLE LINE DIAGRAM

Table 2–2: OTHER DEVICE FUNCTIONS

FUNCTION	FUNCTION	FUNCTION
Breaker Arcing Current (I ² t)	Event Recorder	Oscillography
Contact Inputs (up to 96)	Fault Detector and Fault Report	Setting Groups (6)
Contact Outputs (up to 64)	FlexElements™ (16)	Time Synchronization over SNTP
Control Pushbuttons	FlexLogic™ Equations	Transducer Inputs/Outputs
Data Logger	IEC 61850 Communications	User Definable Displays
Demand	IEC 61850 Remote Inputs/Outputs (GSSE)	User Programmable LEDs
Digital Counters (8)	Metering: Current, Voltage, Power, Energy, Frequency, Harmonics, THD	User Programmable Pushbuttons
Digital Elements (16)	Modbus User Map	User Programmable Self-Tests
Direct Inputs/Outputs (32)	Non-Volatile Latches	Virtual Inputs (32)
DNP 3.0 or IEC 60870-5-104 Comms.	Non-Volatile Selector Switch	Virtual Outputs (64)
Ethernet Global Data (EGD) Protocol		

2.1.2 ORDERING

The relay is available as a 19-inch rack horizontal mount unit or a reduced size (¾) vertical mount unit, and consists of the following modules: power supply, CPU, CT/VT, digital input/output, transducer input/output. Each of these modules can be supplied in a number of configurations specified at the time of ordering. The information required to completely specify the relay is provided in the following table (see Chapter 3 for full details of relay modules).

The order codes for replacement modules to be ordered separately are shown in the following table. When ordering a replacement CPU module or faceplate, please provide the serial number of your existing unit.

Table 2–4: ORDER CODES FOR REPLACEMENT MODULES

	UR - ** -	
POWER SUPPLY (redundant power supply only available in horizontal mount units)	1H	125 / 250 V AC/DC
	1L	24 to 48 V (DC only)
	RH	redundant 125 / 250 V AC/DC
	RH	redundant 24 to 48 V (DC only)
CPU	9E	RS485 and RS485 (ModBus RTU, DNP 3.0)
	9G	RS485 and 10Base-F (IEC 61850, Modbus TCP/IP, DNP 3.0)
	9H	RS485 and Redundant 10Base-F (IEC 61850, ModBus TCP/IP, DNP 3.0)
FACEPLATE	3C	Horizontal faceplate with display and keypad
	3F	Vertical faceplate with display and keypad
	3P	Horizontal faceplate with display, keypad, and user-programmable pushbuttons
DIGITAL INPUTS/OUTPUTS	4A	4 Solid-State (no monitoring) MOSFET Outputs
	4B	4 Solid-State (voltage with optional current) MOSFET Outputs
	4C	4 Solid-State (current with optional voltage) MOSFET Outputs
	4L	14 Form-A (no monitoring) Latching Outputs
	67	8 Form-A (no monitoring) Outputs
	6A	2 Form-A (voltage with optional current) and 2 Form-C Outputs, 8 Digital Inputs
	6B	2 Form-A (voltage with optional current) and 4 Form-C Outputs, 4 Digital Inputs
	6C	8 Form-C Outputs
	6D	16 Digital Inputs
	6E	4 Form-C Outputs, 8 Digital Inputs
	6F	8 Fast Form-C Outputs
	6G	4 Form-A (voltage with optional current) Outputs, 8 Digital Inputs
	6H	6 Form-A (voltage with optional current) Outputs, 4 Digital Inputs
	6K	4 Form-C & 4 Fast Form-C Outputs
	6L	2 Form-A (current with optional voltage) and 2 Form-C Outputs, 8 Digital Inputs
	6M	2 Form-A (current with optional voltage) and 4 Form-C Outputs, 4 Digital Inputs
	6N	4 Form-A (current with optional voltage) Outputs, 8 Digital Inputs
	6P	6 Form-A (current with optional voltage) Outputs, 4 Digital Inputs
	6R	2 Form-A (no monitoring) and 2 Form-C Outputs, 8 Digital Inputs
	6S	2 Form-A (no monitoring) and 4 Form-C Outputs, 4 Digital Inputs
6T	4 Form-A (no monitoring) Outputs, 8 Digital Inputs	
6U	6 Form-A (no monitoring) Outputs, 4 Digital Inputs	
CT/VT MODULES (NOT AVAILABLE FOR THE C30)	8F	Standard 4CT/4VT
	8G	Sensitive Ground 4CT/4VT
	8H	Standard 8CT
	8J	Sensitive Ground 8CT
UR INTER-RELAY COMMUNICATIONS	2A	C37.94SM, 1300nm single-mode, ELED, 1 channel single-mode
	2B	C37.94SM, 1300nm single-mode, ELED, 2 channel single-mode
	72	1550 nm, single-mode, LASER, 1 Channel
	73	1550 nm, single-mode, LASER, 2 Channel
	74	Channel 1 - RS422; Channel 2 - 1550 nm, single-mode, LASER
	75	Channel 1 - G.703; Channel 2 - 1550 nm, Single-mode LASER
	76	IEEE C37.94, 820 nm, multimode, LED, 1 Channel
	77	IEEE C37.94, 820 nm, multimode, LED, 2 Channels
	7A	820 nm, multi-mode, LED, 1 Channel
	7B	1300 nm, multi-mode, LED, 1 Channel
	7C	1300 nm, single-mode, ELED, 1 Channel
	7D	1300 nm, single-mode, LASER, 1 Channel
	7E	Channel 1 - G.703; Channel 2 - 820 nm, multi-mode
	7F	Channel 1 - G.703; Channel 2 - 1300 nm, multi-mode
	7G	Channel 1 - G.703; Channel 2 - 1300 nm, single-mode ELED
	7H	820 nm, multi-mode, LED, 2 Channels
	7I	1300 nm, multi-mode, LED, 2 Channels
	7J	1300 nm, single-mode, ELED, 2 Channels
	7K	1300 nm, single-mode, LASER, 2 Channels
	7L	Channel 1 - RS422; Channel 2 - 820 nm, multi-mode, LED
	7M	Channel 1 - RS422; Channel 2 - 1300 nm, multi-mode, LED
	7N	Channel 1 - RS422; Channel 2 - 1300 nm, single-mode, ELED
	7P	Channel 1 - RS422; Channel 2 - 1300 nm, single-mode, LASER
7Q	Channel 1 - G.703; Channel 2 - 1300 nm, single-mode LASER	
7R	G.703, 1 Channel	
7S	G.703, 2 Channels	
7T	RS422, 1 Channel	
7W	RS422, 2 Channels	
TRANSDUCER INPUTS/OUTPUTS	5A	4 dcmA Inputs, 4 dcmA Outputs (only one 5A module is allowed)
	5C	8 RTD Inputs
	5D	4 RTD Inputs, 4 dcmA Outputs (only one 5D module is allowed)
	5E	4 dcmA Inputs, 4 RTD Inputs
	5F	8 dcmA Inputs

SPECIFICATIONS ARE SUBJECT TO CHANGE WITHOUT NOTICE

2.2.1 PROTECTION ELEMENTS



The operating times below include the activation time of a trip rated Form-A output contact unless otherwise indicated. FlexLogic™ operands of a given element are 4 ms faster. This should be taken into account when using FlexLogic™ to interconnect with other protection or control elements of the relay, building FlexLogic™ equations, or interfacing with other IEDs or power system devices via communications or different output contacts.

PHASE/NEUTRAL/GROUND TOC

Current:	Phasor or RMS
Pickup level:	0.000 to 30.000 pu in steps of 0.001
Dropout level:	97% to 98% of Pickup
Level accuracy:	
for 0.1 to 2.0 × CT:	±0.5% of reading or ±1% of rated (whichever is greater)
for > 2.0 × CT:	±1.5% of reading > 2.0 × CT rating
Curve shapes:	IEEE Moderately/Very/Extremely Inverse; IEC (and BS) A/B/C and Short Inverse; GE IAC Inverse, Short/Very/Extremely Inverse; I ² t; FlexCurves™ (programmable); Definite Time (0.01 s base curve)
Curve multiplier:	Time Dial = 0.00 to 600.00 in steps of 0.01
Reset type:	Instantaneous/Timed (per IEEE)
Timing accuracy:	Operate at > 1.03 × actual Pickup ±3.5% of operate time or ±½ cycle (whichever is greater)

PHASE/NEUTRAL/GROUND IOC

Pickup level:	0.000 to 30.000 pu in steps of 0.001
Dropout level:	97 to 98% of pickup
Level accuracy:	
0.1 to 2.0 × CT rating:	±0.5% of reading or ±1% of rated (whichever is greater)
> 2.0 × CT rating	±1.5% of reading
Overreach:	<2%
Pickup delay:	0.00 to 600.00 s in steps of 0.01
Reset delay:	0.00 to 600.00 s in steps of 0.01
Operate time:	<16 ms at 3 × Pickup at 60 Hz (Phase/Ground IOC) <20 ms at 3 × Pickup at 60 Hz (Neutral IOC)
Timing accuracy:	Operate at 1.5 × Pickup ±3% or ±4 ms (whichever is greater)

PHASE UNDERVOLTAGE

Pickup level:	0.000 to 3.000 pu in steps of 0.001
Dropout level:	102 to 103% of Pickup
Level accuracy:	±0.5% of reading from 10 to 208 V
Curve shapes:	GE IAV Inverse; Definite Time (0.1s base curve)
Curve multiplier:	Time Dial = 0.00 to 600.00 in steps of 0.01
Timing accuracy:	Operate at < 0.90 × Pickup ±3.5% of operate time or ±4 ms (whichever is greater)

AUXILIARY UNDERVOLTAGE

Pickup level:	0.000 to 3.000 pu in steps of 0.001
Dropout level:	102 to 103% of pickup
Level accuracy:	±0.5% of reading from 10 to 208 V
Curve shapes:	GE IAV Inverse, Definite Time
Curve multiplier:	Time Dial = 0 to 600.00 in steps of 0.01
Timing accuracy:	±3% of operate time or ±4 ms (whichever is greater)

NEUTRAL OVERVOLTAGE

Pickup level:	0.000 to 1.250 pu in steps of 0.001
Dropout level:	97 to 98% of Pickup
Level accuracy:	±0.5% of reading from 10 to 208 V
Pickup delay:	0.00 to 600.00 s in steps of 0.01
Reset delay:	0.00 to 600.00 s in steps of 0.01
Timing accuracy:	±3% or ±4 ms (whichever is greater)
Operate time:	< 30 ms at 1.10 × Pickup at 60 Hz

AUXILIARY OVERVOLTAGE

Pickup level:	0.000 to 3.000 pu in steps of 0.001
Dropout level:	97 to 98% of Pickup
Level accuracy:	±0.5% of reading from 10 to 208 V
Pickup delay:	0 to 600.00 s in steps of 0.01
Reset delay:	0 to 600.00 s in steps of 0.01
Timing accuracy:	±3% of operate time or ±4 ms (whichever is greater)
Operate time:	< 30 ms at 1.10 × pickup at 60 Hz

UNDERFREQUENCY

Minimum signal:	0.10 to 1.25 pu in steps of 0.01
Pickup level:	20.00 to 65.00 Hz in steps of 0.01
Dropout level:	Pickup + 0.03 Hz
Level accuracy:	±0.01 Hz
Time delay:	0 to 65.535 s in steps of 0.001
Timer accuracy:	±3% or 4 ms, whichever is greater

BREAKER ARCING CURRENT

Principle:	accumulates breaker duty (I ² t) and measures fault duration
Initiation:	programmable per phase from any FlexLogic™ operand
Compensation for auxiliary relays:	0 to 65.535 s in steps of 0.001
Alarm threshold:	0 to 50000 kA ² -cycle in steps of 1
Fault duration accuracy:	0.25 of a power cycle
Availability:	1 per CT bank with a minimum of 2

AUTORECLOSURE

Single breaker applications, 3-pole tripping schemes
 Up to 4 reclose attempts before lockout
 Independent dead time setting before each shot
 Possibility of changing protection settings after each shot with FlexLogic™

2

2.2.2 USER-PROGRAMMABLE ELEMENTS**FLEXLOGIC™**

Programming language: Reverse Polish Notation with graphical visualization (keypad programmable)
 Lines of code: 512
 Internal variables: 64
 Supported operations: NOT, XOR, OR (2 to 16 inputs), AND (2 to 16 inputs), NOR (2 to 16 inputs), NAND (2 to 16 inputs), Latch (Reset dominant), Edge Detectors, Timers
 Inputs: any logical variable, contact, or virtual input
 Number of timers: 32
 Pickup delay: 0 to 60000 (ms, sec., min.) in steps of 1
 Dropout delay: 0 to 60000 (ms, sec., min.) in steps of 1

FLEXCURVES™

Number: 4 (A through D)
 Reset points: 40 (0 through 1 of pickup)
 Operate points: 80 (1 through 20 of pickup)
 Time delay: 0 to 65535 ms in steps of 1

FLEX STATES

Number: up to 256 logical variables grouped under 16 Modbus addresses
 Programmability: any logical variable, contact, or virtual input

FLEXELEMENTS™

Number of elements: 16
 Number of elements: 8
 Operating signal: any analog actual value, or two values in differential mode
 Operating signal mode: Signed or Absolute Value
 Operating mode: Level, Delta
 Comparator direction: Over, Under
 Pickup Level: -30.000 to 30.000 pu in steps of 0.001
 Hysteresis: 0.1 to 50.0% in steps of 0.1
 Delta dt: 20 ms to 60 days
 Pickup & dropout delay: 0.000 to 65.535 s in steps of 0.001

NON-VOLATILE LATCHES

Type: Set-dominant or Reset-dominant
 Number: 16 (individually programmed)
 Output: Stored in non-volatile memory
 Execution sequence: As input prior to protection, control, and FlexLogic™

USER-PROGRAMMABLE LEDs

Number: 48 plus Trip and Alarm
 Programmability: from any logical variable, contact, or virtual input
 Reset mode: Self-reset or Latched

LED TEST

Initiation: from any digital input or user-programmable condition
 Number of tests: 3, interruptible at any time
 Duration of full test: approximately 3 minutes
 Test sequence 1: all LEDs on
 Test sequence 2: all LEDs off, one LED at a time on for 1 s
 Test sequence 3: all LEDs on, one LED at a time off for 1 s

USER-DEFINABLE DISPLAYS

Number of displays: 16
 Lines of display: 2 × 20 alphanumeric characters
 Parameters: up to 5, any Modbus register addresses
 Invoking and scrolling: keypad, or any user-programmable condition, including pushbuttons

CONTROL PUSHBUTTONS

Number of pushbuttons: 7
 Operation: drive FlexLogic™ operands

USER-PROGRAMMABLE PUSHBUTTONS (OPTIONAL)

Number of pushbuttons: 12
 Mode: Self-Reset, Latched
 Display message: 2 lines of 20 characters each

SELECTOR SWITCH

Number of elements: 2
 Upper position limit: 1 to 7 in steps of 1
 Selecting mode: Time-out or Acknowledge
 Time-out timer: 3.0 to 60.0 s in steps of 0.1
 Control inputs: step-up and 3-bit
 Power-up mode: restore from non-volatile memory or synchronize to a 3-bit control input

8-BIT SWITCH

Number of elements: 6
 Input signals: two 8-bit integers via FlexLogic™ operands
 Control signal: any FlexLogic™ operand
 Response time: < 8 ms at 60 Hz, < 10 ms at 50 Hz

2.2.3 MONITORING

OSCILLOGRAPHY

Maximum records:	64
Sampling rate:	64 samples per power cycle
Triggers:	Any element pickup, dropout or operate Digital input change of state Digital output change of state FlexLogic™ equation
Data:	AC input channels Element state Digital input state Digital output state
Data storage:	In non-volatile memory

EVENT RECORDER

Capacity:	1024 events
Time-tag:	to 1 microsecond
Triggers:	Any element pickup, dropout or operate Digital input change of state Digital output change of state Self-test events
Data storage:	In non-volatile memory

DATA LOGGER

Number of channels:	1 to 16
Parameters:	Any available analog actual value
Sampling rate:	1 sec.; 1, 5, 10, 15, 20, 30, 60 min.
Storage capacity:	(NN is dependent on memory)
1-second rate:	01 channel for NN days 16 channels for NN days
↓	↓
60-minute rate:	01 channel for NN days 16 channels for NN days

FAULT LOCATOR

Number of independent fault locators:	1 per CT bank (to a maximum of 5)
Method:	Single-ended
Maximum accuracy if:	Fault resistance is zero or fault currents from all line terminals are in phase
Relay accuracy:	±1.5% (V > 10 V, I > 0.1 pu)
Worst-case accuracy:	
	VT _{%error} + (user data)
	CT _{%error} + (user data)
	Z _{Line} _{%error} + (user data)
	METHOD _{%error} + (Chapter 6)
	RELAY ACCURACY _{%error} + (1.5%)

2.2.4 METERING

RMS CURRENT: PHASE, NEUTRAL, AND GROUND

Accuracy at	
0.1 to 2.0 × CT rating:	±0.25% of reading or ±0.1% of rated (whichever is greater)
> 2.0 × CT rating:	±1.0% of reading

RMS VOLTAGE

Accuracy:	±0.5% of reading from 10 to 208 V
-----------	-----------------------------------

REAL POWER (WATTS)

Accuracy:	±1.0% of reading at −0.8 < PF ≤ −1.0 and 0.8 < PF ≤ 1.0
-----------	--

REACTIVE POWER (VARs)

Accuracy:	±1.0% of reading at −0.2 ≤ PF ≤ 0.2
-----------	-------------------------------------

APPARENT POWER (VA)

Accuracy:	±1.0% of reading
-----------	------------------

WATT-HOURS (POSITIVE AND NEGATIVE)

Accuracy:	±2.0% of reading
Range:	±0 to 2 × 10 ⁹ MWh
Parameters:	3-phase only
Update rate:	50 ms

VAR-HOURS (POSITIVE AND NEGATIVE)

Accuracy:	±2.0% of reading
Range:	±0 to 2 × 10 ⁹ Mvarh
Parameters:	3-phase only
Update rate:	50 ms

VOLTAGE HARMONICS

Harmonics:	2nd to 25th harmonic: per phase, displayed as a % of f ₁ (fundamental frequency phasor) THD: per phase, displayed as a % of f ₁
------------	--

Accuracy:

HARMONICS:	1. f ₁ > 0.4pu: (0.20% + 0.035% / harmonic) of reading or 0.15% of 100%, whichever is greater 2. f ₁ < 0.4pu: as above plus %error of f ₁
THD:	1. f ₁ > 0.4pu: (0.25% + 0.035% / harmonic) of reading or 0.20% of 100%, whichever is greater 2. f ₁ < 0.4pu: as above plus %error of f ₁

FREQUENCY

Accuracy at	
V = 0.8 to 1.2 pu:	±0.01 Hz (when voltage signal is used for frequency measurement)
I = 0.1 to 0.25 pu:	±0.05 Hz
I > 0.25 pu:	±0.02 Hz (when current signal is used for frequency measurement)

DEMAND

Measurements:	Phases A, B, and C present and maximum measured currents 3-Phase Power (P, Q, and S) present and maximum measured currents
Accuracy:	±2.0%

2.2.5 INPUTS

AC CURRENT

CT rated primary:	1 to 50000 A
CT rated secondary:	1 A or 5 A by connection
Nominal frequency:	20 to 65 Hz
Relay burden:	< 0.2 VA at rated secondary
Conversion range:	
Standard CT:	0.02 to 46 × CT rating RMS symmetrical
Sensitive Ground module:	0.002 to 4.6 × CT rating RMS symmetrical
Current withstand:	20 ms at 250 times rated 1 sec. at 100 times rated continuous at 3 times rated

AC VOLTAGE

VT rated secondary:	50.0 to 240.0 V
VT ratio:	1.00 to 24000.00
Nominal frequency:	20 to 65 Hz
Relay burden:	< 0.25 VA at 120 V
Conversion range:	1 to 275 V
Voltage withstand:	continuous at 260 V to neutral 1 min./hr at 420 V to neutral

CONTACT INPUTS

Dry contacts:	1000 Ω maximum
Wet contacts:	300 V DC maximum
Selectable thresholds:	17 V, 33 V, 84 V, 166 V
Tolerance:	±10%
Recognition time:	< 1 ms
Debounce timer:	0.0 to 16.0 ms in steps of 0.5

DCMA INPUTS

Current input (mA DC):	0 to -1, 0 to +1, -1 to +1, 0 to 5, 0 to 10, 0 to 20, 4 to 20 (programmable)
Input impedance:	379 Ω ±10%
Conversion range:	-1 to + 20 mA DC
Accuracy:	±0.2% of full scale
Type:	Passive

RTD INPUTS

Types (3-wire):	100 Ω Platinum, 100 & 120 Ω Nickel, 10 Ω Copper
Sensing current:	5 mA
Range:	-50 to +250°C
Accuracy:	±2°C
Isolation:	36 V pk-pk

IRIG-B INPUT

Amplitude modulation:	1 to 10 V pk-pk
DC shift:	TTL
Input impedance:	22 kΩ
Isolation:	2 kV

REMOTE INPUTS (MMS GOOSE)

Number of input points:	32, configured from 64 incoming bit pairs
Number of remote devices:	16
Default states on loss of comms.:	On, Off, Latest/Off, Latest/On

DIRECT INPUTS

Number of input points:	32
No. of remote devices:	16
Default states on loss of comms.:	On, Off, Latest/Off, Latest/On
Ring configuration:	Yes, No
Data rate:	64 or 128 kbps
CRC:	32-bit
CRC alarm:	
Responding to:	Rate of messages failing the CRC
Monitoring message count:	10 to 10000 in steps of 1
Alarm threshold:	1 to 1000 in steps of 1
Unreturned message alarm:	
Responding to:	Rate of unreturned messages in the ring configuration
Monitoring message count:	10 to 10000 in steps of 1
Alarm threshold:	1 to 1000 in steps of 1

2.2.6 POWER SUPPLY

LOW RANGE

Nominal DC voltage:	24 to 48 V at 3 A
Min/max DC voltage:	20 / 60 V
NOTE:	Low range is DC only.

HIGH RANGE

Nominal DC voltage:	125 to 250 V at 0.7 A
Min/max DC voltage:	88 / 300 V
Nominal AC voltage:	100 to 240 V at 50/60 Hz, 0.7 A
Min/max AC voltage:	88 / 265 V at 48 to 62 Hz

ALL RANGES

Volt withstand:	2 × Highest Nominal Voltage for 10 ms
Voltage loss hold-up:	50 ms duration at nominal
Power consumption:	Typical = 15 VA; Max. = 30 VA

INTERNAL FUSE**RATINGS**

Low range power supply:	7.5 A / 600 V
High range power supply:	5 A / 600 V

INTERRUPTING CAPACITY

AC:	100 000 A RMS symmetrical
DC:	10 000 A

2.2.7 OUTPUTS

FORM-A RELAY

Make and carry for 0.2 s: 30 A as per ANSI C37.90
 Carry continuous: 6 A
 Break at L/R of 40 ms: 0.25 A DC max. at 48 V
 0.10 A DC max. at 125 V
 Operate time: < 4 ms
 Contact material: Silver alloy

LATCHING RELAY

Make and carry for 0.2 s: 30 A as per ANSI C37.90
 Carry continuous: 6 A
 Break at L/R of 40 ms: 0.25 A DC max.
 Operate time: < 4 ms
 Contact material: Silver alloy
 Control: separate operate and reset inputs
 Control mode: operate-dominant or reset-dominant

FORM-A VOLTAGE MONITOR

Applicable voltage: approx. 15 to 250 V DC
 Trickle current: approx. 1 to 2.5 mA

FORM-A CURRENT MONITOR

Threshold current: approx. 80 to 100 mA

FORM-C AND CRITICAL FAILURE RELAY

Make and carry for 0.2 s: 10 A
 Carry continuous: 6 A
 Break at L/R of 40 ms: 0.25 A DC max. at 48 V
 0.10 A DC max. at 125 V
 Operate time: < 8 ms
 Contact material: Silver alloy

FAST FORM-C RELAY

Make and carry: 0.1 A max. (resistive load)
 Minimum load impedance:

INPUT VOLTAGE	IMPEDANCE	
	2 W RESISTOR	1 W RESISTOR
250 V DC	20 KΩ	50 KΩ
120 V DC	5 KΩ	2 KΩ
48 V DC	2 KΩ	2 KΩ
24 V DC	2 KΩ	2 KΩ

Note: values for 24 V and 48 V are the same due to a required 95% voltage drop across the load impedance.

Operate time: < 0.6 ms
 Internal Limiting Resistor: 100 Ω, 2 W

SOLID-STATE OUTPUT RELAY

Operate and release time: <100 μs
 Maximum voltage: 265 V DC
 Maximum continuous current: 5 A at 45°C; 4 A at 65°C
 Make and carry for 0.2 s: as per ANSI C37.90
 Breaking capacity:

	IEC 647-5 / UL508	Utility application (autoreclose scheme)	Industrial application
Operations/interval	5000 ops / 1 s-On, 9 s-Off	5 ops / 0.2 s-On, 0.2 s-Off within 1 minute	10000 ops / 0.2 s-On, 30 s-Off
Break capability (0 to 250 V DC)	3.2 A L/R = 10 ms	10 A L/R = 40 ms	10 A L/R = 40 ms
	1.6 A L/R = 20 ms		
	0.8 A L/R = 40 ms		

IRIG-B OUTPUT

Amplitude: 10 V peak-peak RS485 level
 Maximum load: 100 ohms
 Time delay: 1 ms for AM input
 40 μs for DC-shift input
 Isolation: 2 kV

CONTROL POWER EXTERNAL OUTPUT (FOR DRY CONTACT INPUT)

Capacity: 100 mA DC at 48 V DC
 Isolation: ±300 Vpk

REMOTE OUTPUTS (IEC 61850 GSSE)

Standard output points: 32
 User output points: 32

DIRECT OUTPUTS

Output points: 32

DCMA OUTPUTS

Range: -1 to 1 mA, 0 to 1 mA, 4 to 20 mA
 Max. load resistance: 12 kΩ for -1 to 1 mA range
 12 kΩ for 0 to 1 mA range
 600 Ω for 4 to 20 mA range

Accuracy: ±0.75% of full-scale for 0 to 1 mA range
 ±0.5% of full-scale for -1 to 1 mA range
 ±0.75% of full-scale for 0 to 20 mA range

99% Settling time to a step change: 100 ms

Isolation: 1.5 kV
 Driving signal: any FlexAnalog quantity
 Upper and lower limit for the driving signal: -90 to 90 pu in steps of 0.001

RS232

Front port: 19.2 kbps, Modbus® RTU

RS485

1 or 2 rear ports: Up to 115 kbps, Modbus® RTU, isolated together at 36 Vpk

Typical distance: 1200 m

Isolation: 2 kV

ETHERNET PORT

10Base-F: 820 nm, multi-mode, supports half-duplex/full-duplex fiber optic with ST connector

Redundant 10Base-F: 820 nm, multi-mode, half-duplex/full-duplex fiber optic with ST connector

10Base-T: RJ45 connector

Power budget: 10 db

Max optical input power: -7.6 dBm

Max optical output power: -20 dBm

Receiver sensitivity: -30 dBm

Typical distance: 1.65 km

SNTP clock synchronization error: <10 ms (typical)

2.2.8 COMMUNICATIONS**2.2.9 INTER-RELAY COMMUNICATIONS****SHIELDED TWISTED-PAIR INTERFACE OPTIONS**

INTERFACE TYPE	TYPICAL DISTANCE
RS422	1200 m
G.703	100 m



RS422 distance is based on transmitter power and does not take into consideration the clock source provided by the user.

LINK POWER BUDGET

EMITTER, FIBER TYPE	TRANSMIT POWER	RECEIVED SENSITIVITY	POWER BUDGET
820 nm LED, Multimode	-20 dBm	-30 dBm	10 dB
1300 nm LED, Multimode	-21 dBm	-30 dBm	9 dB
1300 nm ELED, Singlemode	-21 dBm	-30 dBm	9 dB
1300 nm Laser, Singlemode	-1 dBm	-30 dBm	29 dB
1550 nm Laser, Singlemode	+5 dBm	-30 dBm	35 dB



These Power Budgets are calculated from the manufacturer's worst-case transmitter power and worst case receiver sensitivity.

MAXIMUM OPTICAL INPUT POWER

EMITTER, FIBER TYPE	MAX. OPTICAL INPUT POWER
820 nm LED, Multimode	-7.6 dBm
1300 nm LED, Multimode	-11 dBm
1300 nm ELED, Singlemode	-14 dBm
1300 nm Laser, Singlemode	-14 dBm
1550 nm Laser, Singlemode	-14 dBm

TYPICAL LINK DISTANCE

EMITTER TYPE	FIBER TYPE	CONNECTOR TYPE	TYPICAL DISTANCE
820 nm LED	Multimode	ST	1.65 km
1300 nm LED	Multimode	ST	3.8 km
1300 nm ELED	Singlemode	ST	11.4 km
1300 nm Laser	Singlemode	ST	64 km
1550 nm Laser	Singlemode	ST	105 km



Typical distances listed are based on the following assumptions for system loss. As actual losses will vary from one installation to another, the distance covered by your system may vary.

CONNECTOR LOSSES (TOTAL OF BOTH ENDS)

ST connector 2 dB

FIBER LOSSES

820 nm multimode 3 dB/km

1300 nm multimode 1 dB/km

1300 nm singlemode 0.35 dB/km

1550 nm singlemode 0.25 dB/km

Splice losses: One splice every 2 km, at 0.05 dB loss per splice.

SYSTEM MARGIN

3 dB additional loss added to calculations to compensate for all other losses.

Compensated difference in transmitting and receiving (channel asymmetry) channel delays using GPS satellite clock: 10 ms

2.2.10 ENVIRONMENTAL

OPERATING TEMPERATURES

Cold: IEC 60028-2-1, 16 h at -40°C
 Dry Heat: IEC 60028-2-2, 16 h at +85°C

OTHER

Humidity (noncondensing): IEC 60068-2-30, 95%, Variant 1, 6 days
 Altitude: Up to 2000 m
 Installation Category: II

2.2.11 TYPE TESTS

Electrical fast transient: ANSI/IEEE C37.90.1
 IEC 61000-4-4
 IEC 60255-22-4
 Oscillatory transient: ANSI/IEEE C37.90.1
 IEC 61000-4-12
 Insulation resistance: IEC 60255-5
 Dielectric strength: IEC 60255-6
 ANSI/IEEE C37.90
 Electrostatic discharge: EN 61000-4-2
 Surge immunity: EN 61000-4-5
 RFI susceptibility: ANSI/IEEE C37.90.2
 IEC 61000-4-3
 IEC 60255-22-3
 Ontario Hydro C-5047-77

Conducted RFI: IEC 61000-4-6
 Voltage dips/interruptions/variatioins:
 IEC 61000-4-11
 IEC 60255-11
 Power frequency magnetic field immunity:
 IEC 61000-4-8
 Vibration test (sinusoidal): IEC 60255-21-1
 Shock and bump: IEC 60255-21-2



Type test report available upon request.

2.2.12 PRODUCTION TESTS

THERMAL

Products go through an environmental test based upon an Accepted Quality Level (AQL) sampling process.

2.2.13 APPROVALS

APPROVALS

UL Listed for the USA and Canada

CE:
 LVD 73/23/EEC: IEC 1010-1
 EMC 81/336/EEC: EN 50081-2, EN 50082-2

2.2.14 MAINTENANCE

MOUNTING

Attach mounting brackets using 20 inch-pounds (± 2 inch-pounds) of torque.

CLEANING

Normally, cleaning is not required; but for situations where dust has accumulated on the faceplate display, a dry cloth can be used.

2

3.1.1 PANEL CUTOUT

The relay is available as a 19-inch rack horizontal mount unit or as a reduced size (¾) vertical mount unit, with a removable faceplate. The modular design allows the relay to be easily upgraded or repaired by a qualified service person. The faceplate is hinged to allow easy access to the removable modules, and is itself removable to allow mounting on doors with limited rear depth. There is also a removable dust cover that fits over the faceplate, which must be removed when attempting to access the keypad or RS232 communications port.

The vertical and horizontal case dimensions are shown below, along with panel cutout details for panel mounting. When planning the location of your panel cutout, ensure that provision is made for the faceplate to swing open without interference to or from adjacent equipment.

The relay must be mounted such that the faceplate sits semi-flush with the panel or switchgear door, allowing the operator access to the keypad and the RS232 communications port. The relay is secured to the panel with the use of four screws supplied with the relay.

3

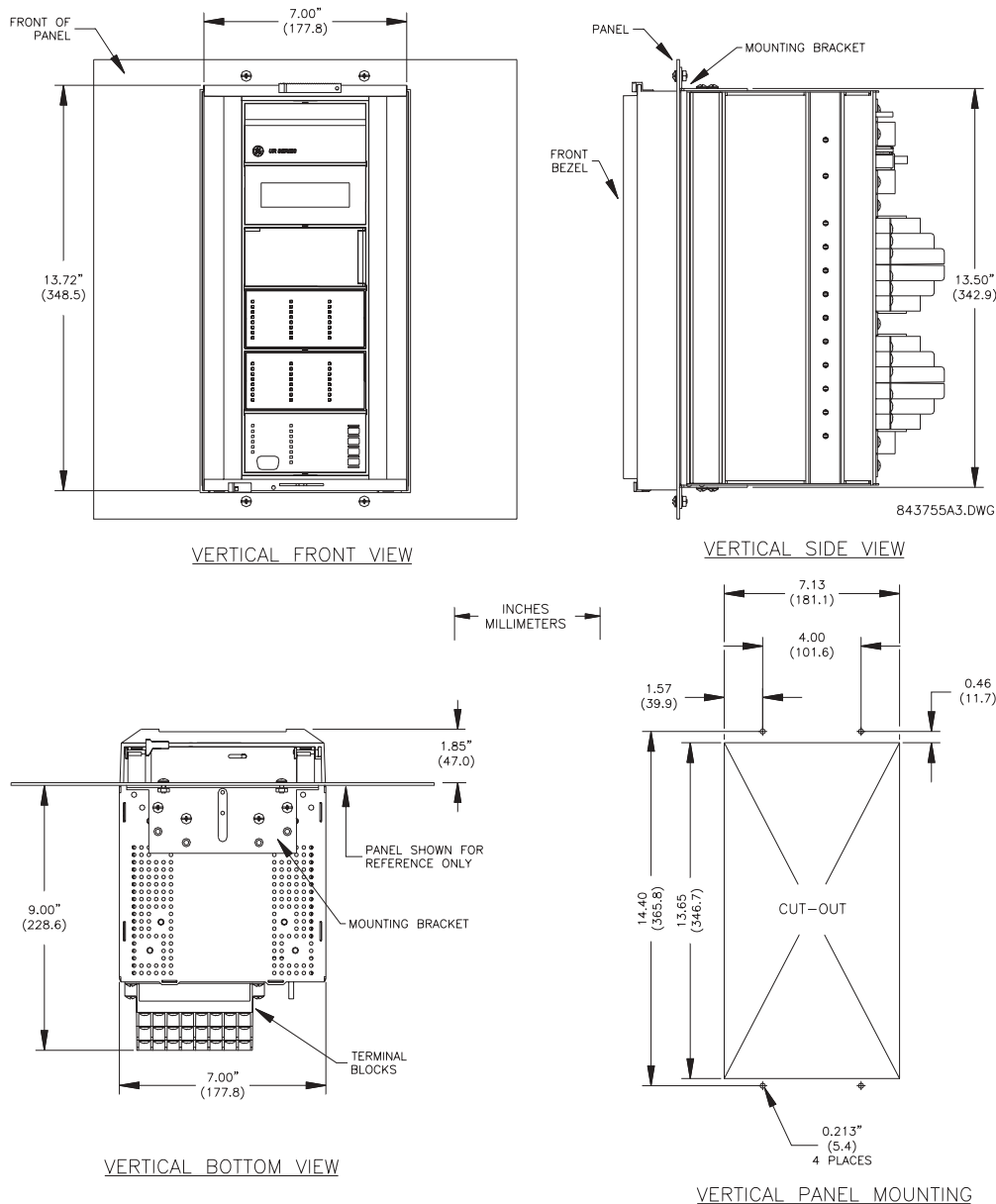

Figure 3-1: F35 VERTICAL MOUNTING AND DIMENSIONS

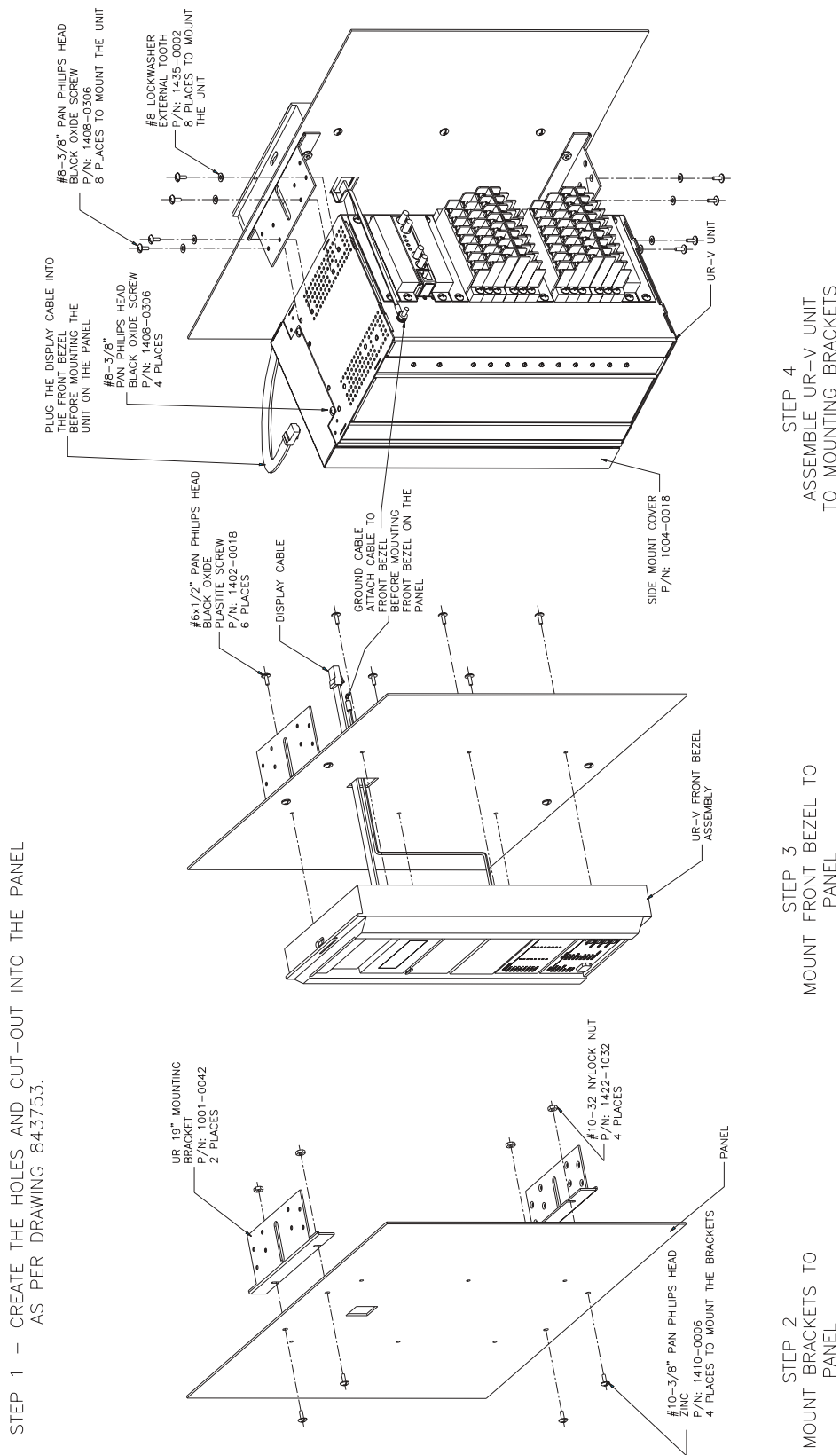

Figure 3-2: F35 VERTICAL SIDE MOUNTING INSTALLATION

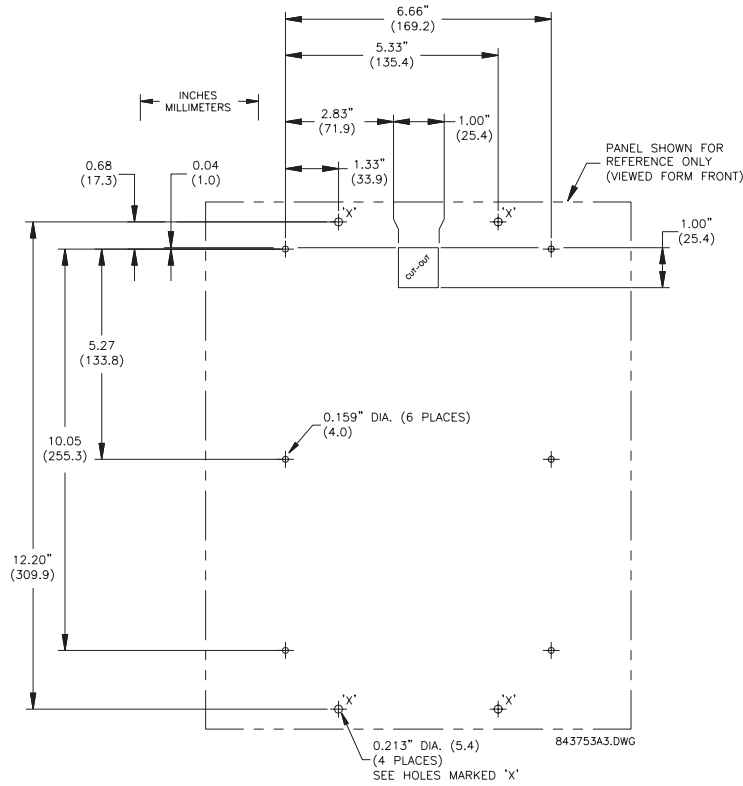

Figure 3-3: F35 VERTICAL SIDE MOUNTING REAR DIMENSIONS

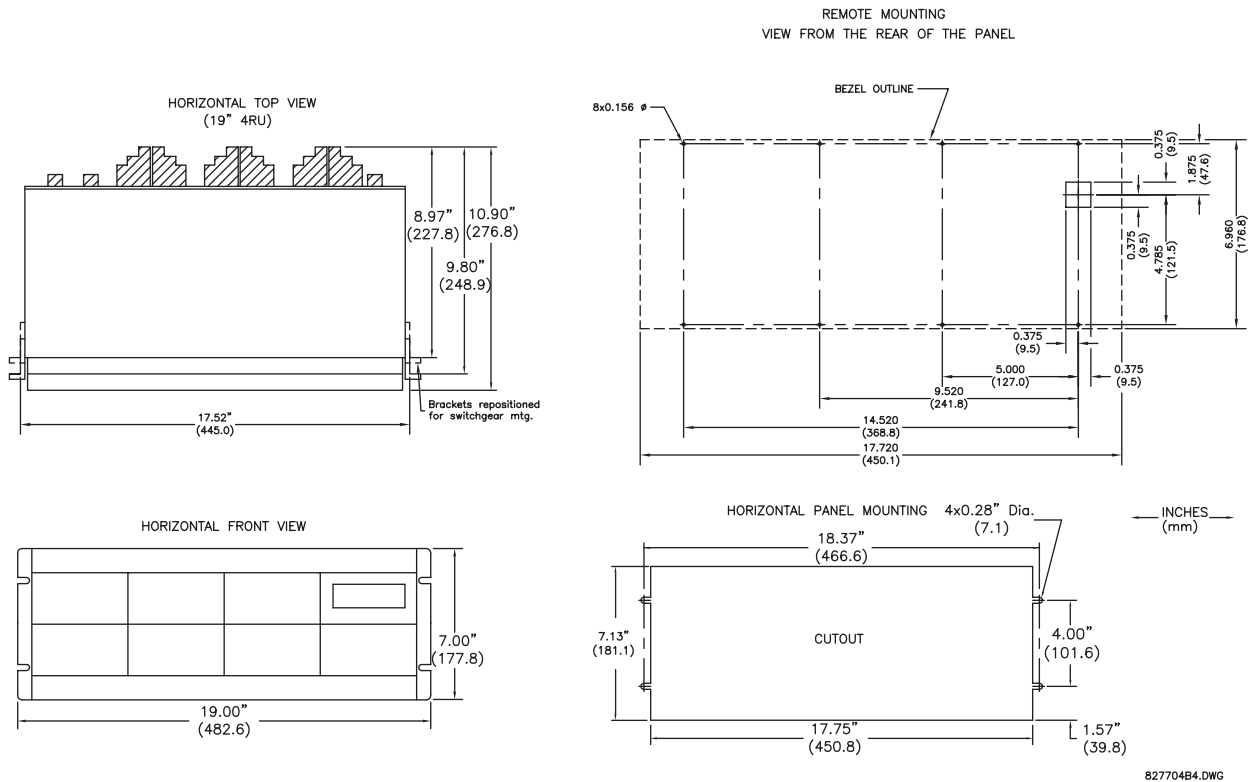

Figure 3-4: F35 HORIZONTAL MOUNTING AND DIMENSIONS

3.1.2 MODULE WITHDRAWAL AND INSERTION



Module withdrawal and insertion may only be performed when control power has been removed from the unit. Inserting an incorrect module type into a slot may result in personal injury, damage to the unit or connected equipment, or undesired operation!



Proper electrostatic discharge protection (i.e. a static strap) must be used when coming in contact with modules while the relay is energized!

The relay, being modular in design, allows for the withdrawal and insertion of modules. Modules must only be replaced with like modules in their original factory configured slots. The faceplate can be opened to the left, once the sliding latch on the right side has been pushed up, as shown below. This allows for easy accessibility of the modules for withdrawal.

3



Figure 3-5: UR MODULE WITHDRAWAL/INSERTION

- **MODULE WITHDRAWAL:** The ejector/inserter clips, located at the top and bottom of each module, must be pulled simultaneously to release the module for removal. Before performing this action, **control power must be removed from the relay**. Record the original location of the module to ensure that the same or replacement module is inserted into the correct slot. Modules with current input provide automatic shorting of external CT circuits.
- **MODULE INSERTION:** Ensure that the **correct** module type is inserted into the **correct** slot position. The ejector/inserter clips located at the top and at the bottom of each module must be in the disengaged position as the module is smoothly inserted into the slot. Once the clips have cleared the raised edge of the chassis, engage the clips simultaneously. When the clips have locked into position, the module will be fully inserted.



Type 9G and 9H CPU modules are equipped with 10Base-T and 10Base-F Ethernet connectors. These connectors must be individually disconnected from the module before the it can be removed from the chassis.



The version 4.0 release of the F35 relay includes new hardware (CPU and CT/VT modules). The new CPU modules are specified with the following order codes: 9E, 9G, and 9H. The new CT/VT modules are specified with the following order codes: 8F, 8G, 8H, 8J.

The new CT/VT modules (8F, 8G, 8H, 8J) can only be used with the new CPUs (9E, 9G, 9H); similarly, the old CT/VT modules (8A, 8B, 8C, 8D) can only be used with the old CPUs (9A, 9C, 9D). To prevent hardware mismatches, the new CPU and CT/VT modules have blue labels and a warning sticker stating “**Attn.: Ensure CPU and DSP module label colors are the same!**”. In the event that there is a mismatch between the CPU and CT/VT module, the relay will not function and a **DSP ERROR** or **HARDWARE MISMATCH** error will be displayed.

All other input/output modules are compatible with the new hardware. Firmware versions 4.0x and higher are only compatible with the new CPU and CT/VT modules. Previous versions of the firmware (3.4x and earlier) are only compatible with the older CPU and CT/VT modules.

3.1.3 REAR TERMINAL LAYOUT



832766A1.CDR

Figure 3-6: REAR TERMINAL VIEW



Do not touch any rear terminals while the relay is energized!

The relay follows a convention with respect to terminal number assignments which are three characters long assigned in order by module slot position, row number, and column letter. Two-slot wide modules take their slot designation from the first slot position (nearest to CPU module) which is indicated by an arrow marker on the terminal block. See the following figure for an example of rear terminal assignments.

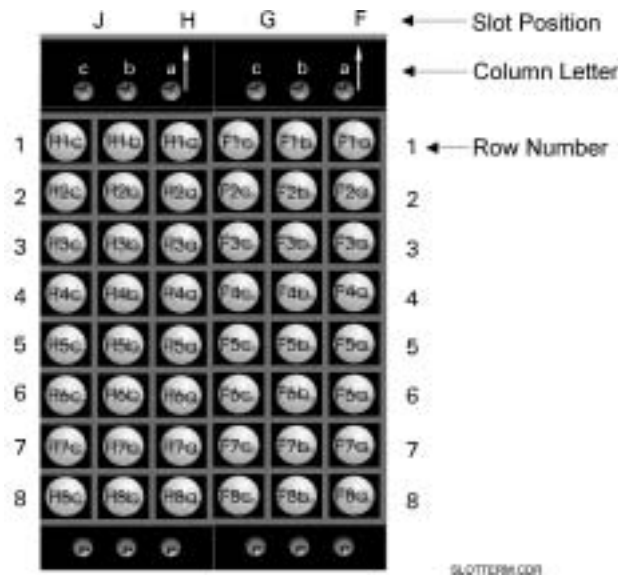
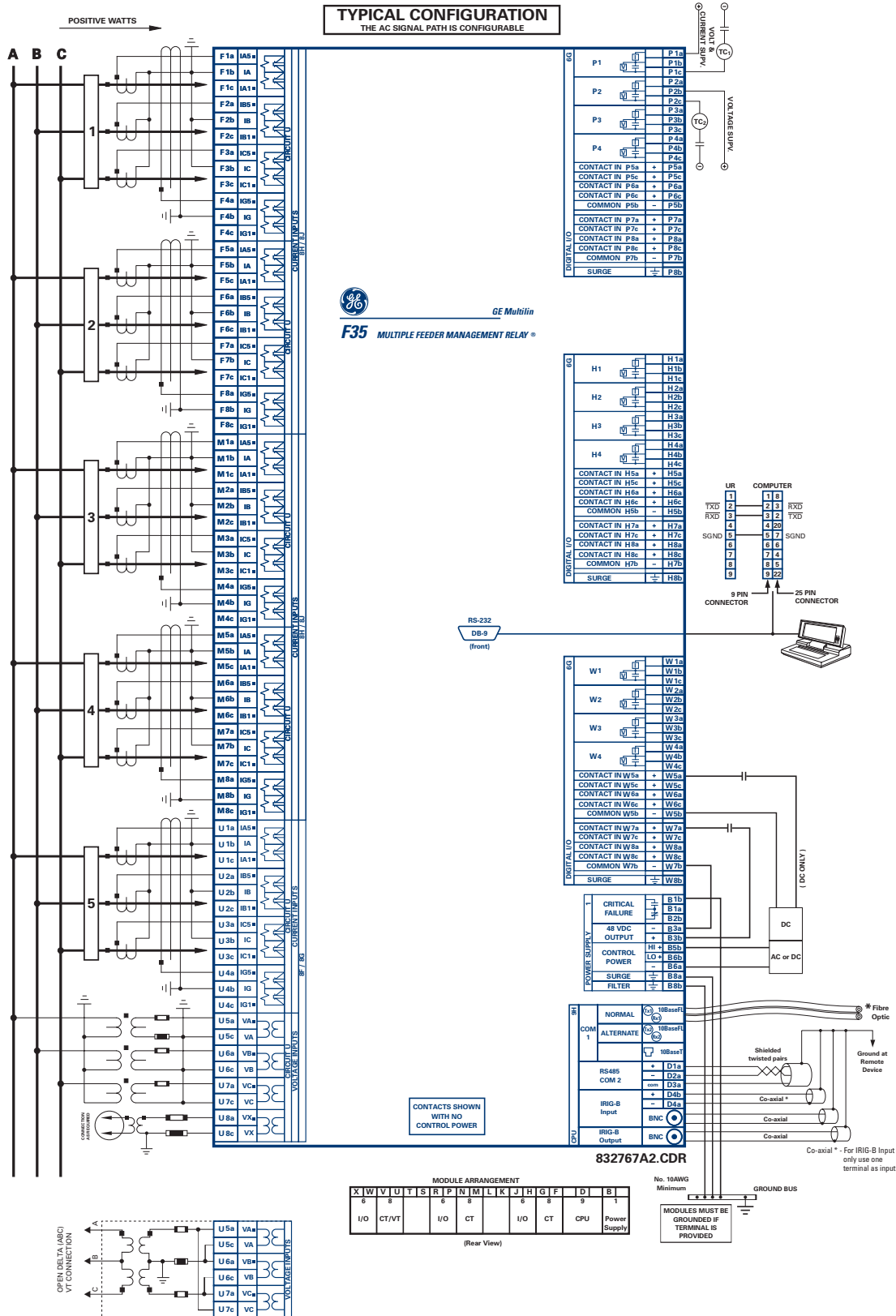

Figure 3-7: EXAMPLE OF MODULES IN F AND H SLOTS

3.2.1 TYPICAL WIRING



This diagram is based on the following order code: F35-H00-HCH-F8H-H6G-M8H-P6G-U8F-W6G.
The purpose of this diagram is to provide an example of how the relay is typically wired, not specifically how to wire your own relay. Please refer to the following pages for examples to help you wire your relay correctly based on your own relay configuration and order code.



Figure 3-8: TYPICAL WIRING DIAGRAM

3.2.2 DIELECTRIC STRENGTH

The dielectric strength of the UR-series module hardware is shown in the following table:

Table 3–1: DIELECTRIC STRENGTH OF UR-SERIES MODULE HARDWARE

MODULE TYPE	MODULE FUNCTION	TERMINALS		DIELECTRIC STRENGTH (AC)
		FROM	TO	
1	Power Supply	High (+); Low (+); (–)	Chassis	2000 V AC for 1 minute
1	Power Supply	48 V DC (+) and (–)	Chassis	2000 V AC for 1 minute
1	Power Supply	Relay Terminals	Chassis	2000 V AC for 1 minute
2	Reserved	N/A	N/A	N/A
3	Reserved	N/A	N/A	N/A
4	Reserved	N/A	N/A	N/A
5	Analog Inputs/Outputs	All except 8b	Chassis	< 50 V DC
6	Digital Inputs/Outputs	All (See Precaution 2)	Chassis	2000 V AC for 1 minute
7	G.703	All except 2b, 3a, 7b, 8a	Chassis	2000 V AC for 1 minute
	RS422	All except 6a, 7b, 8a	Chassis	< 50 V DC
8	CT/VT	All	Chassis	2000 V AC for 1 minute
9	CPU	All	Chassis	2000 V AC for 1 minute

Filter networks and transient protection clamps are used in module hardware to prevent damage caused by high peak voltage transients, radio frequency interference (RFI) and electromagnetic interference (EMI). These protective components **can be damaged** by application of the ANSI/IEEE C37.90 specified test voltage for a period longer than the specified one minute.

3.2.3 CONTROL POWER



CONTROL POWER SUPPLIED TO THE RELAY MUST BE CONNECTED TO THE MATCHING POWER SUPPLY RANGE OF THE RELAY. IF THE VOLTAGE IS APPLIED TO THE WRONG TERMINALS, DAMAGE MAY OCCUR!



The F35 relay, like almost all electronic relays, contains electrolytic capacitors. These capacitors are well known to be subject to deterioration over time if voltage is not applied periodically. Deterioration can be avoided by powering the relays up once a year.

The power supply module can be ordered for two possible voltage ranges. Each range has a dedicated input connection for proper operation. The ranges are as shown below (see the Technical Specifications section for additional details):

- LO range: 24 to 48 V (DC only) nominal
- HI range: 125 to 250 V nominal

The power supply module provides power to the relay and supplies power for dry contact input connections.

The power supply module provides 48 V DC power for dry contact input connections and a critical failure relay (see the Typical Wiring Diagram earlier). The critical failure relay is a Form-C that will be energized once control power is applied and the relay has successfully booted up with no critical self-test failures. If on-going self-test diagnostic checks detect a critical failure (see the Self-Test Errors table in Chapter 7) or control power is lost, the relay will de-energize.

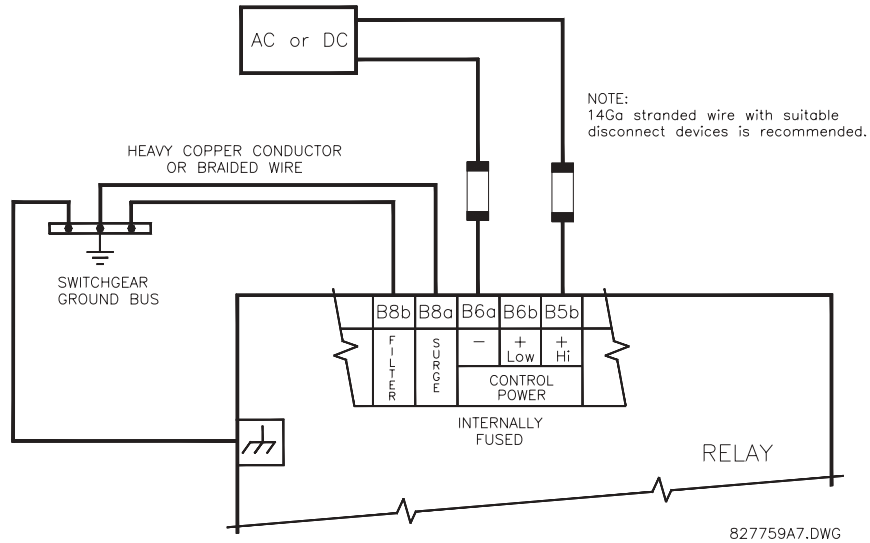

Figure 3-9: CONTROL POWER CONNECTION

3.2.4 CT/VT MODULES

A CT/VT module may have voltage inputs on Channels 1 through 4 inclusive, or Channels 5 through 8 inclusive. Channels 1 and 5 are intended for connection to Phase A, and are labeled as such in the relay. Channels 2 and 6 are intended for connection to Phase B, and are labeled as such in the relay. Channels 3 and 7 are intended for connection to Phase C and are labeled as such in the relay. Channels 4 and 8 are intended for connection to a single phase source. If voltage, this channel is labelled the auxiliary voltage (VX). If current, this channel is intended for connection to a CT between a system neutral and ground, and is labelled the ground current (IG).

a) CT INPUTS



VERIFY THAT THE CONNECTION MADE TO THE RELAY NOMINAL CURRENT OF 1 A OR 5 A MATCHES THE SECONDARY RATING OF THE CONNECTED CTs. UNMATCHED CTs MAY RESULT IN EQUIPMENT DAMAGE OR INADEQUATE PROTECTION.

The CT/VT module may be ordered with a standard ground current input that is the same as the phase current inputs (Type 8F) or with a sensitive ground input (Type 8G) which is 10 times more sensitive (see the Technical Specifications section for additional details). Each AC current input has an isolating transformer and an automatic shorting mechanism that shorts the input when the module is withdrawn from the chassis. There are no internal ground connections on the current inputs. Current transformers with 1 to 50000 A primaries and 1 A or 5 A secondaries may be used.

CT connections for both ABC and ACB phase rotations are identical as shown in the *Typical Wiring Diagram*.

The exact placement of a zero-sequence CT so that ground fault current will be detected is shown below. Twisted pair cabling on the zero-sequence CT is recommended.

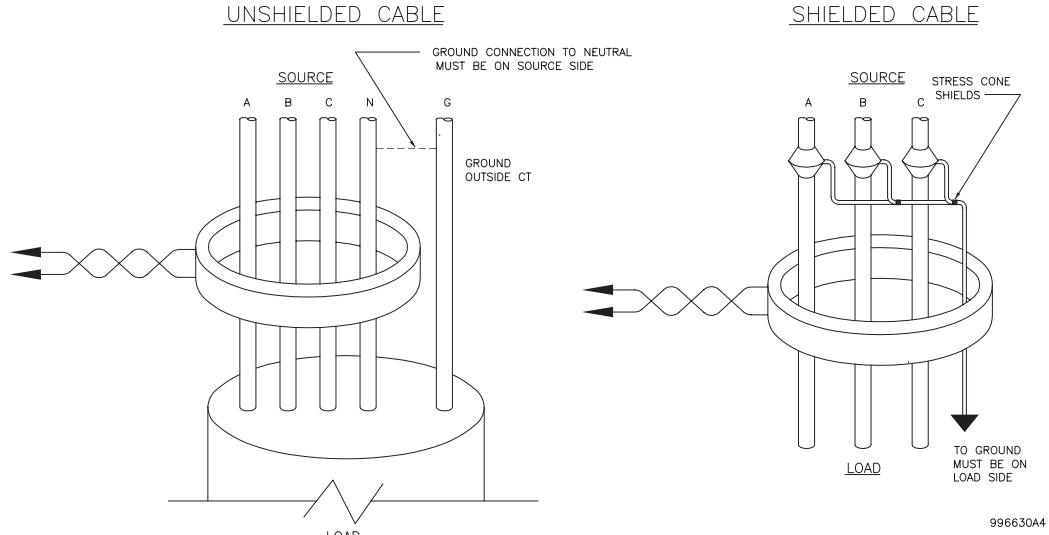

Figure 3-10: ZERO-SEQUENCE CORE BALANCE CT INSTALLATION

b) VT INPUTS

The phase voltage channels are used for most metering and protection purposes. The auxiliary voltage channel is used as input for the Synchrocheck and Volts/Hertz features.

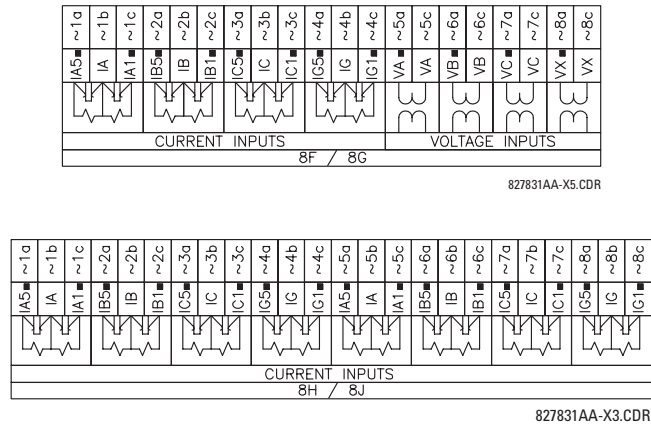

Figure 3-11: CT/VT MODULE WIRING



Wherever a tilde “~” symbol appears, substitute with the Slot Position of the module.

3.2.5 CONTACT INPUTS/OUTPUTS

Every digital input/output module has 24 terminal connections. They are arranged as 3 terminals per row, with 8 rows in total. A given row of three terminals may be used for the outputs of one relay. For example, for Form-C relay outputs, the terminals connect to the normally open (NO), normally closed (NC), and common contacts of the relay. For a Form-A output, there are options of using current or voltage detection for feature supervision, depending on the module ordered. The terminal configuration for contact inputs is different for the two applications. When a digital input/output module is ordered with contact inputs, they are arranged in groups of four and use two rows of three terminals. Ideally, each input would be totally isolated from any other input. However, this would require that every input have two dedicated terminals and limit the available number of contacts based on the available number of terminals. So, although each input is individually optically isolated, each group of four inputs uses a single common as a reasonable compromise. This allows each group of four outputs to be supplied by wet contacts from different voltage sources (if required) or a mix of wet and dry contacts.

3

The tables and diagrams on the following pages illustrate the module types (6A, etc.) and contact arrangements that may be ordered for the relay. Since an entire row is used for a single contact output, the name is assigned using the module slot position and row number. However, since there are two contact inputs per row, these names are assigned by module slot position, row number, and column position.

UR-SERIES FORM-A / SOLID STATE (SSR) OUTPUT CONTACTS:

Some Form-A/SSR outputs include circuits to monitor the DC voltage across the output contact when it is open, and the DC current through the output contact when it is closed. Each of the monitors contains a level detector whose output is set to logic “On = 1” when the current in the circuit is above the threshold setting. The voltage monitor is set to “On = 1” when the current is above about 1 to 2.5 mA, and the current monitor is set to “On = 1” when the current exceeds about 80 to 100 mA. The voltage monitor is intended to check the health of the overall trip circuit, and the current monitor can be used to seal-in the output contact until an external contact has interrupted current flow. The block diagrams of the circuits are below above for the Form-A outputs with:

- a) optional voltage monitor
- b) optional current monitor
- c) with no monitoring

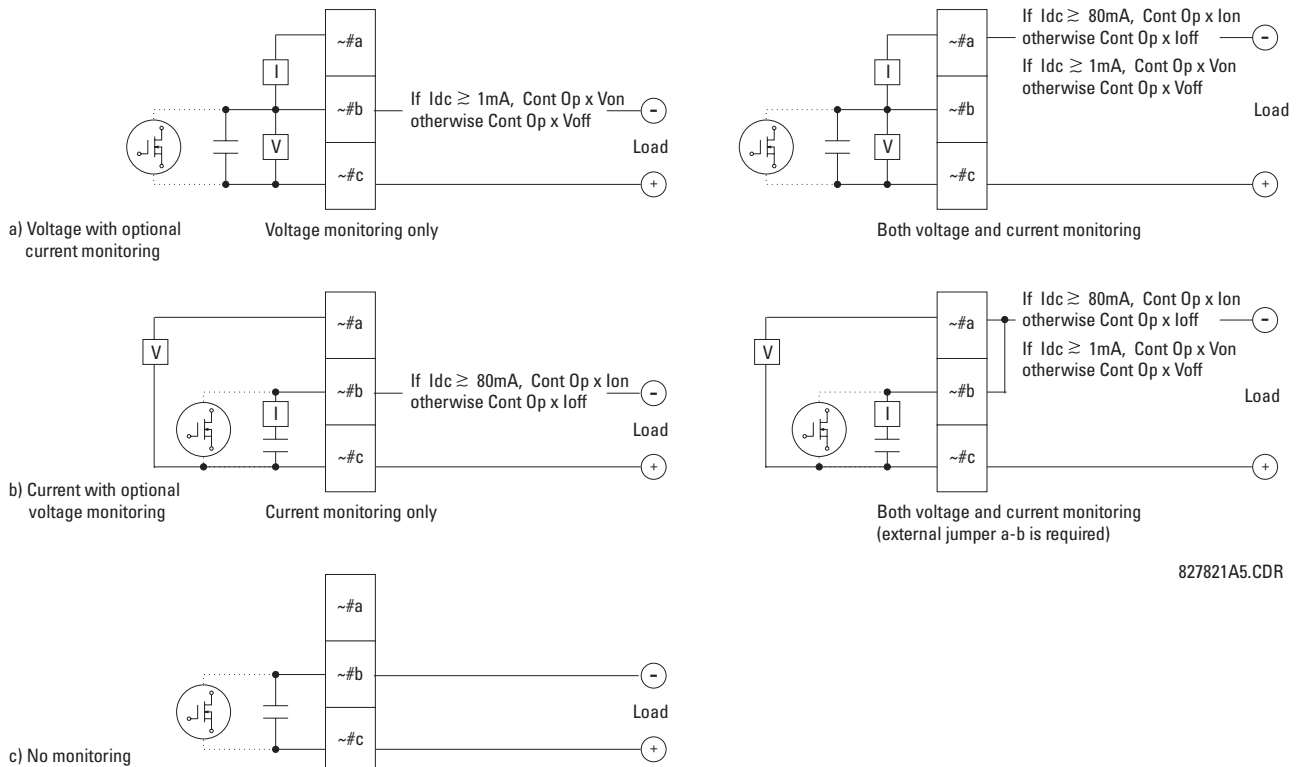

Figure 3-12: FORM-A /SOLID STATE CONTACT FUNCTIONS

The operation of voltage and current monitors is reflected with the corresponding FlexLogic™ operands (Cont Op # Von, Cont Op # Voff, Cont Op # Ion, and Cont Op # Ioff) which can be used in protection, control and alarm logic. The typical application of the voltage monitor is breaker trip circuit integrity monitoring; a typical application of the current monitor is seal-in of the control command. Refer to the *Digital Elements* section of Chapter 5 for an example of how Form-A/SSR contacts can be applied for breaker trip circuit integrity monitoring.



Relay contacts must be considered unsafe to touch when the unit is energized! If the relay contacts need to be used for low voltage accessible applications, it is the customer's responsibility to ensure proper insulation levels!



USE OF FORM-A/SSR OUTPUTS IN HIGH IMPEDANCE CIRCUITS

For Form-A/SSR output contacts internally equipped with a voltage measuring circuit across the contact, the circuit has an impedance that can cause a problem when used in conjunction with external high input impedance monitoring equipment such as modern relay test set trigger circuits. These monitoring circuits may continue to read the Form-A contact as being closed after it has closed and subsequently opened, when measured as an impedance.

The solution to this problem is to use the voltage measuring trigger input of the relay test set, and connect the Form-A contact through a voltage-dropping resistor to a DC voltage source. If the 48 V DC output of the power supply is used as a source, a 500 Ω, 10 W resistor is appropriate. In this configuration, the voltage across either the Form-A contact or the resistor can be used to monitor the state of the output.



Wherever a tilde “~” symbol appears, substitute with the Slot Position of the module; wherever a number sign “#” appears, substitute the contact number



When current monitoring is used to seal-in the Form-A/SSR contact outputs, the FlexLogic™ operand driving the contact output should be given a reset delay of 10 ms to prevent damage of the output contact (in situations when the element initiating the contact output is bouncing, at values in the region of the pickup value).

Table 3–2: DIGITAL INPUT/OUTPUT MODULE ASSIGNMENTS

~6A I/O MODULE		~6B I/O MODULE		~6C I/O MODULE		~6D I/O MODULE	
TERMINAL ASSIGNMENT	OUTPUT OR INPUT	TERMINAL ASSIGNMENT	OUTPUT OR INPUT	TERMINAL ASSIGNMENT	OUTPUT	TERMINAL ASSIGNMENT	OUTPUT
~1	Form-A	~1	Form-A	~1	Form-C	~1a, ~1c	2 Inputs
~2	Form-A	~2	Form-A	~2	Form-C	~2a, ~2c	2 Inputs
~3	Form-C	~3	Form-C	~3	Form-C	~3a, ~3c	2 Inputs
~4	Form-C	~4	Form-C	~4	Form-C	~4a, ~4c	2 Inputs
~5a, ~5c	2 Inputs	~5	Form-C	~5	Form-C	~5a, ~5c	2 Inputs
~6a, ~6c	2 Inputs	~6	Form-C	~6	Form-C	~6a, ~6c	2 Inputs
~7a, ~7c	2 Inputs	~7a, ~7c	2 Inputs	~7	Form-C	~7a, ~7c	2 Inputs
~8a, ~8c	2 Inputs	~8a, ~8c	2 Inputs	~8	Form-C	~8a, ~8c	2 Inputs

~6E I/O MODULE		~6F I/O MODULE		~6G I/O MODULE		~6H I/O MODULE	
TERMINAL ASSIGNMENT	OUTPUT OR INPUT	TERMINAL ASSIGNMENT	OUTPUT	TERMINAL ASSIGNMENT	OUTPUT OR INPUT	TERMINAL ASSIGNMENT	OUTPUT OR INPUT
~1	Form-C	~1	Fast Form-C	~1	Form-A	~1	Form-A
~2	Form-C	~2	Fast Form-C	~2	Form-A	~2	Form-A
~3	Form-C	~3	Fast Form-C	~3	Form-A	~3	Form-A
~4	Form-C	~4	Fast Form-C	~4	Form-A	~4	Form-A
~5a, ~5c	2 Inputs	~5	Fast Form-C	~5a, ~5c	2 Inputs	~5	Form-A
~6a, ~6c	2 Inputs	~6	Fast Form-C	~6a, ~6c	2 Inputs	~6	Form-A
~7a, ~7c	2 Inputs	~7	Fast Form-C	~7a, ~7c	2 Inputs	~7a, ~7c	2 Inputs
~8a, ~8c	2 Inputs	~8	Fast Form-C	~8a, ~8c	2 Inputs	~8a, ~8c	2 Inputs

~6K I/O MODULE	
TERMINAL ASSIGNMENT	OUTPUT
~1	Form-C
~2	Form-C
~3	Form-C
~4	Form-C
~5	Fast Form-C
~6	Fast Form-C
~7	Fast Form-C
~8	Fast Form-C

~6L I/O MODULE	
TERMINAL ASSIGNMENT	OUTPUT OR INPUT
~1	Form-A
~2	Form-A
~3	Form-C
~4	Form-C
~5a, ~5c	2 Inputs
~6a, ~6c	2 Inputs
~7a, ~7c	2 Inputs
~8a, ~8c	2 Inputs

~6M I/O MODULE	
TERMINAL ASSIGNMENT	OUTPUT OR INPUT
~1	Form-A
~2	Form-A
~3	Form-C
~4	Form-C
~5	Form-C
~6	Form-C
~7a, ~7c	2 Inputs
~8a, ~8c	2 Inputs

~6N I/O MODULE	
TERMINAL ASSIGNMENT	OUTPUT OR INPUT
~1	Form-A
~2	Form-A
~3	Form-A
~4	Form-A
~5a, ~5c	2 Inputs
~6a, ~6c	2 Inputs
~7a, ~7c	2 Inputs
~8a, ~8c	2 Inputs

~6P I/O MODULE	
TERMINAL ASSIGNMENT	OUTPUT OR INPUT
~1	Form-A
~2	Form-A
~3	Form-A
~4	Form-A
~5	Form-A
~6	Form-A
~7a, ~7c	2 Inputs
~8a, ~8c	2 Inputs

~6R I/O MODULE	
TERMINAL ASSIGNMENT	OUTPUT OR INPUT
~1	Form-A
~2	Form-A
~3	Form-C
~4	Form-C
~5a, ~5c	2 Inputs
~6a, ~6c	2 Inputs
~7a, ~7c	2 Inputs
~8a, ~8c	2 Inputs

~6S I/O MODULE	
TERMINAL ASSIGNMENT	OUTPUT OR INPUT
~1	Form-A
~2	Form-A
~3	Form-C
~4	Form-C
~5	Form-C
~6	Form-C
~7a, ~7c	2 Inputs
~8a, ~8c	2 Inputs

~6T I/O MODULE	
TERMINAL ASSIGNMENT	OUTPUT OR INPUT
~1	Form-A
~2	Form-A
~3	Form-A
~4	Form-A
~5a, ~5c	2 Inputs
~6a, ~6c	2 Inputs
~7a, ~7c	2 Inputs
~8a, ~8c	2 Inputs

~6U I/O MODULE	
TERMINAL ASSIGNMENT	OUTPUT OR INPUT
~1	Form-A
~2	Form-A
~3	Form-A
~4	Form-A
~5	Form-A
~6	Form-A
~7a, ~7c	2 Inputs
~8a, ~8c	2 Inputs

~6V I/O MODULE	
TERMINAL ASSIGNMENT	OUTPUT
~1	Form-A
~2	Form-A
~3	Form-A
~4	Form-A
~5	Form-A
~6	Form-A
~7	Form-A
~8	Form-A

~4A I/O MODULE	
TERMINAL ASSIGNMENT	OUTPUT
~1	Not Used
~2	Solid-State
~3	Not Used
~4	Solid-State
~5	Not Used
~6	Solid-State
~7	Not Used
~8	Solid-State

~4B I/O MODULE	
TERMINAL ASSIGNMENT	OUTPUT
~1	Not Used
~2	Solid-State
~3	Not Used
~4	Solid-State
~5	Not Used
~6	Solid-State
~7	Not Used
~8	Solid-State

~4C I/O MODULE	
TERMINAL ASSIGNMENT	OUTPUT
~1	Not Used
~2	Solid-State
~3	Not Used
~4	Solid-State
~5	Not Used
~6	Solid-State
~7	Not Used
~8	Solid-State

~4L I/O MODULE	
TERMINAL ASSIGNMENT	OUTPUT
~1	2 Outputs
~2	2 Outputs
~3	2 Outputs
~4	2 Outputs
~5	2 Outputs
~6	2 Outputs
~7	2 Outputs
~8	Not Used

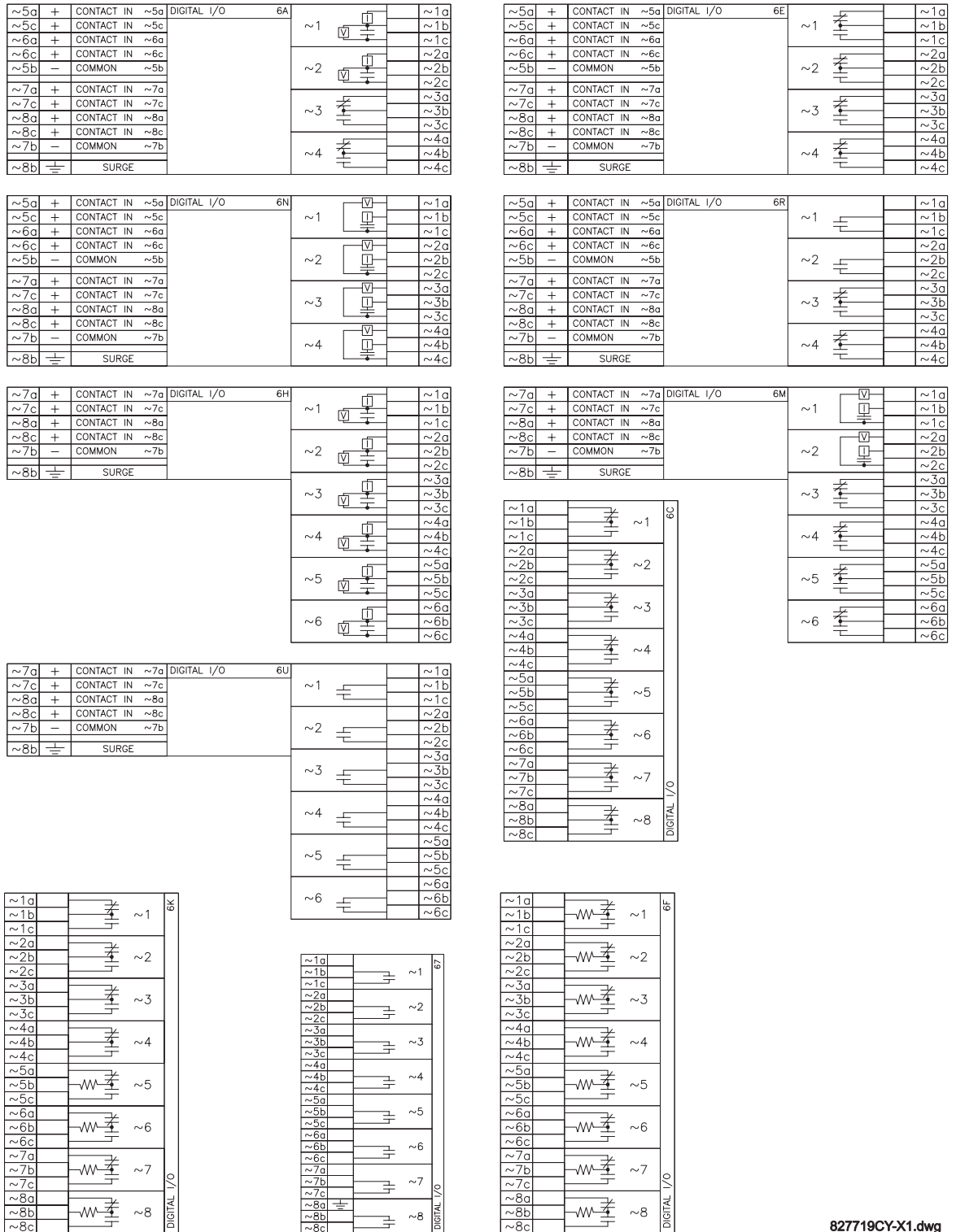
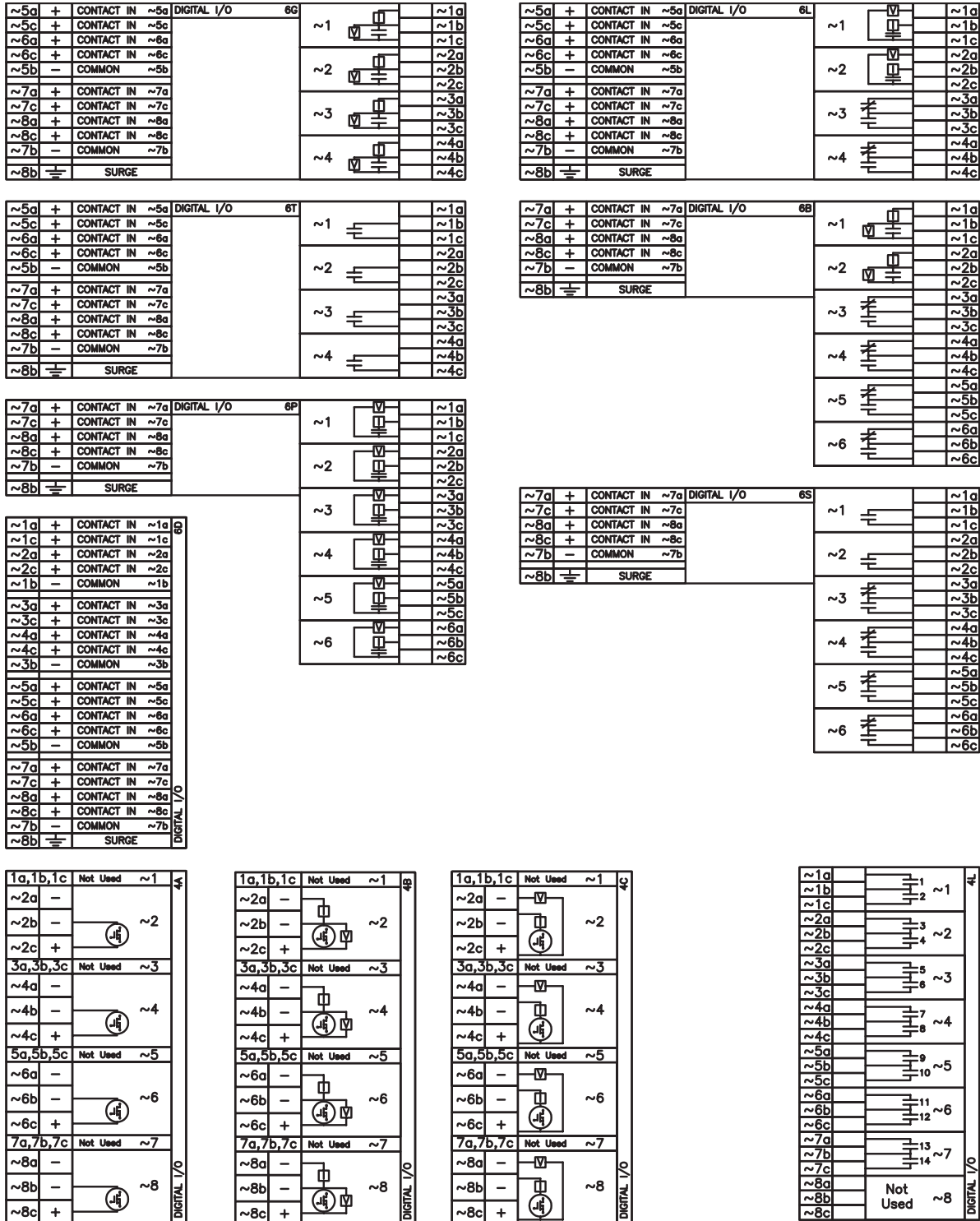

Figure 3-13: DIGITAL INPUT/OUTPUT MODULE WIRING (1 of 2)

3



– MOSFET Solid State Contact

827719CY-X2.dwg

Figure 3-14: DIGITAL INPUT/OUTPUT MODULE WIRING (2 of 2)



CORRECT POLARITY MUST BE OBSERVED FOR ALL CONTACT INPUT AND SOLID STATE OUTPUT CONNECTIONS FOR PROPER FUNCTIONALITY.

A dry contact has one side connected to Terminal B3b. This is the positive 48 V DC voltage rail supplied by the power supply module. The other side of the dry contact is connected to the required contact input terminal. Each contact input group has its own common (negative) terminal which must be connected to the DC negative terminal (B3a) of the power supply module. When a dry contact closes, a current of 1 to 3 mA will flow through the associated circuit.

A wet contact has one side connected to the positive terminal of an external DC power supply. The other side of this contact is connected to the required contact input terminal. In addition, the negative side of the external source must be connected to the relay common (negative) terminal of each contact input group. The maximum external source voltage for this arrangement is 300 V DC.

The voltage threshold at which each group of four contact inputs will detect a closed contact input is programmable as 17 V DC for 24 V sources, 33 V DC for 48 V sources, 84 V DC for 110 to 125 V sources, and 166 V DC for 250 V sources.

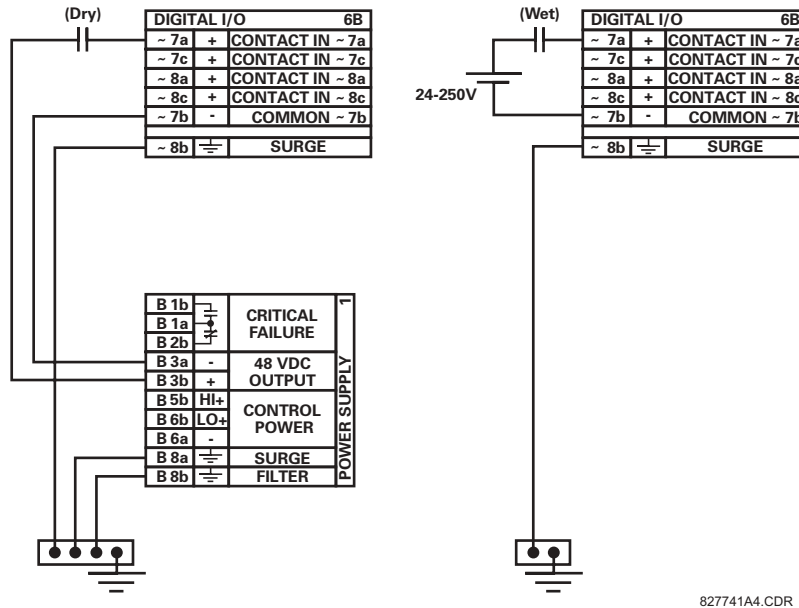

Figure 3-15: DRY AND WET CONTACT INPUT CONNECTIONS



Wherever a tilde “~” symbol appears, substitute with the Slot Position of the module.

Contact outputs may be ordered as Form-A or Form-C. The Form A contacts may be connected for external circuit supervision. These contacts are provided with voltage and current monitoring circuits used to detect the loss of DC voltage in the circuit, and the presence of DC current flowing through the contacts when the Form-A contact closes. If enabled, the current monitoring can be used as a seal-in signal to ensure that the Form-A contact does not attempt to break the energized inductive coil circuit and weld the output contacts.



There is no provision in the relay to detect a DC ground fault on 48 V DC control power external output. We recommend using an external DC supply.

3.2.6 TRANSDUCER INPUTS/OUTPUTS

Transducer input modules can receive input signals from external dcmA output transducers (dcmA In) or resistance temperature detectors (RTD). Hardware and software is provided to receive signals from these external transducers and convert these signals into a digital format for use as required.

Transducer output modules provide DC current outputs in several standard dcmA ranges. Software is provided to configure virtually any analog quantity used in the relay to drive the analog outputs.

Every transducer input/output module has a total of 24 terminal connections. These connections are arranged as three terminals per row with a total of eight rows. A given row may be used for either inputs or outputs, with terminals in column "a" having positive polarity and terminals in column "c" having negative polarity. Since an entire row is used for a single input/output channel, the name of the channel is assigned using the module slot position and row number.

Each module also requires that a connection from an external ground bus be made to Terminal 8b. The current outputs require a twisted-pair shielded cable, where the shield is grounded at one end only. The figure below illustrates the transducer module types (5A, 5C, 5D, 5E, and 5F) and channel arrangements that may be ordered for the relay.

3



Wherever a tilde “~” symbol appears, substitute with the Slot Position of the module.

~1a	+	dcmA In	~1	5A
~1c	-			
~2a	+	dcmA In	~2	
~2c	-			
~3a	+	dcmA In	~3	
~3c	-			
~4a	+	dcmA In	~4	
~4c	-			
~5a	+	dcmA Out	~5	ANALOG I/O
~5c	-			
~6a	+	dcmA Out	~6	
~6c	-			
~7a	+	dcmA Out	~7	
~7c	-			
~8a	+	dcmA Out	~8	
~8c	-			
~8b	⏏	SURGE		

~1a	Hot	RTD	~1	5C
~1c	Comp			
~1b	Return	for RTD ~1& ~2		
~2a	Hot	RTD	~2	
~2c	Comp			
~3a	Hot	RTD	~3	
~3c	Comp			
~3b	Return	for RTD ~3& ~4		
~4a	Hot	RTD	~4	ANALOG I/O
~4c	Comp			
~5a	Hot	RTD	~5	
~5c	Comp			
~5b	Return	for RTD ~5& ~6		
~6a	Hot	RTD	~6	
~6c	Comp			
~7a	Hot	RTD	~7	
~7c	Comp			
~7b	Return	for RTD ~7& ~8		
~8a	Hot	RTD	~8	
~8c	Comp			
~8b	⏏	SURGE		

~1a	Hot	RTD	~1	5D
~1c	Comp			
~1b	Return	for RTD ~1& ~2		
~2a	Hot	RTD	~2	
~2c	Comp			
~3a	Hot	RTD	~3	
~3c	Comp			
~3b	Return	for RTD ~3& ~4		
~4a	Hot	RTD	~4	ANALOG I/O
~4c	Comp			
~5a	+	dcmA Out	~5	
~5c	-			
~6a	+	dcmA Out	~6	
~6c	-			
~7a	+	dcmA Out	~7	
~7c	-			
~8a	+	dcmA Out	~8	
~8c	-			
~8b	⏏	SURGE		

~1a	+	dcmA In	~1	5E
~1c	-			
~2a	+	dcmA In	~2	
~2c	-			
~3a	+	dcmA In	~3	
~3c	-			
~4a	+	dcmA In	~4	
~4c	-			
~5a	Hot	RTD	~5	ANALOG I/O
~5c	Comp			
~5b	Return	for RTD ~5& ~6		
~6a	Hot	RTD	~6	
~6c	Comp			
~7a	Hot	RTD	~7	
~7c	Comp			
~7b	Return	for RTD ~7& ~8		
~8a	Hot	RTD	~8	
~8c	Comp			
~8b	⏏	SURGE		

~1a	+	dcmA In	~1	5F
~1c	-			
~2a	+	dcmA In	~2	
~2c	-			
~3a	+	dcmA In	~3	
~3c	-			
~4a	+	dcmA In	~4	
~4c	-			
~5a	+	dcmA In	~5	ANALOG I/O
~5c	-			
~6a	+	dcmA In	~6	
~6c	-			
~7a	+	dcmA In	~7	
~7c	-			
~8a	+	dcmA In	~8	
~8c	-			
~8b	⏏	SURGE		

827831AB-X1.CDR

Figure 3-16: TRANSDUCER INPUT/OUTPUT MODULE WIRING

3.2.7 RS232 FACEPLATE PORT

A 9-pin RS232C serial port is located on the relay's faceplate for programming with a portable (personal) computer. All that is required to use this interface is a personal computer running the enerVista UR Setup software provided with the relay. Cabling for the RS232 port is shown in the following figure for both 9 pin and 25 pin connectors.



The baud rate for this port is fixed at **19200 bps**.

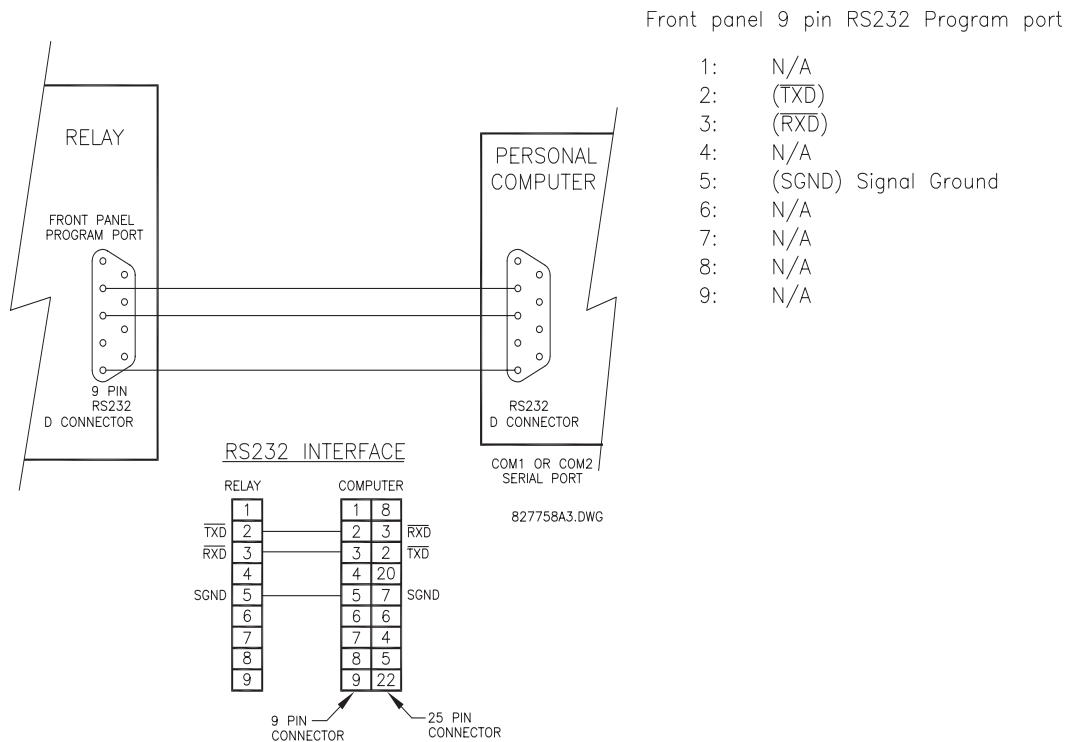

Figure 3-17: RS232 FACEPLATE PORT CONNECTION

3.2.8 CPU COMMUNICATION PORTS

a) OPTIONS

In addition to the RS232 port on the faceplate, the relay provides the user with two additional communication port(s) depending on the CPU module installed.



The 9E, 9G, and 9H CPU modules do not require a surge ground connection.

CPU TYPE	COM1	COM2
9E	RS485	RS485
9G	10Base-F and 10Base-T	RS485
9H	Redundant 10Base-F	RS485

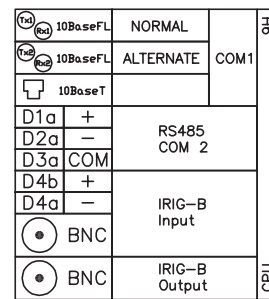
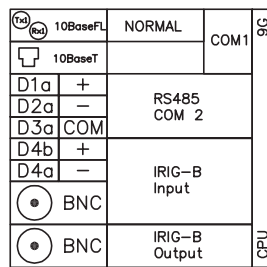
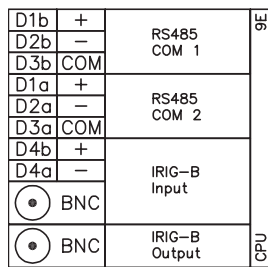

827831AB-X6.DWG

Figure 3-18: CPU MODULE COMMUNICATIONS WIRING

b) RS485 PORTS

RS485 data transmission and reception are accomplished over a single twisted pair with transmit and receive data alternating over the same two wires. Through the use of these port(s), continuous monitoring and control from a remote computer, SCADA system or PLC is possible.

To minimize errors from noise, the use of shielded twisted pair wire is recommended. Correct polarity must also be observed. For instance, the relays must be connected with all RS485 “+” terminals connected together, and all RS485 “-” terminals connected together. The COM terminal should be connected to the common wire inside the shield, when provided. To avoid loop currents, the shield should be grounded at one point only. Each relay should also be daisy chained to the next one in the link. A maximum of 32 relays can be connected in this manner without exceeding driver capability. For larger systems, additional serial channels must be added. It is also possible to use commercially available repeaters to increase the number of relays on a single channel to more than 32. Star or stub connections should be avoided entirely.

Lightning strikes and ground surge currents can cause large momentary voltage differences between remote ends of the communication link. For this reason, surge protection devices are internally provided at both communication ports. An isolated power supply with an optocoupled data interface also acts to reduce noise coupling. To ensure maximum reliability, all equipment should have similar transient protection devices installed.

Both ends of the RS485 circuit should also be terminated with an impedance as shown below.

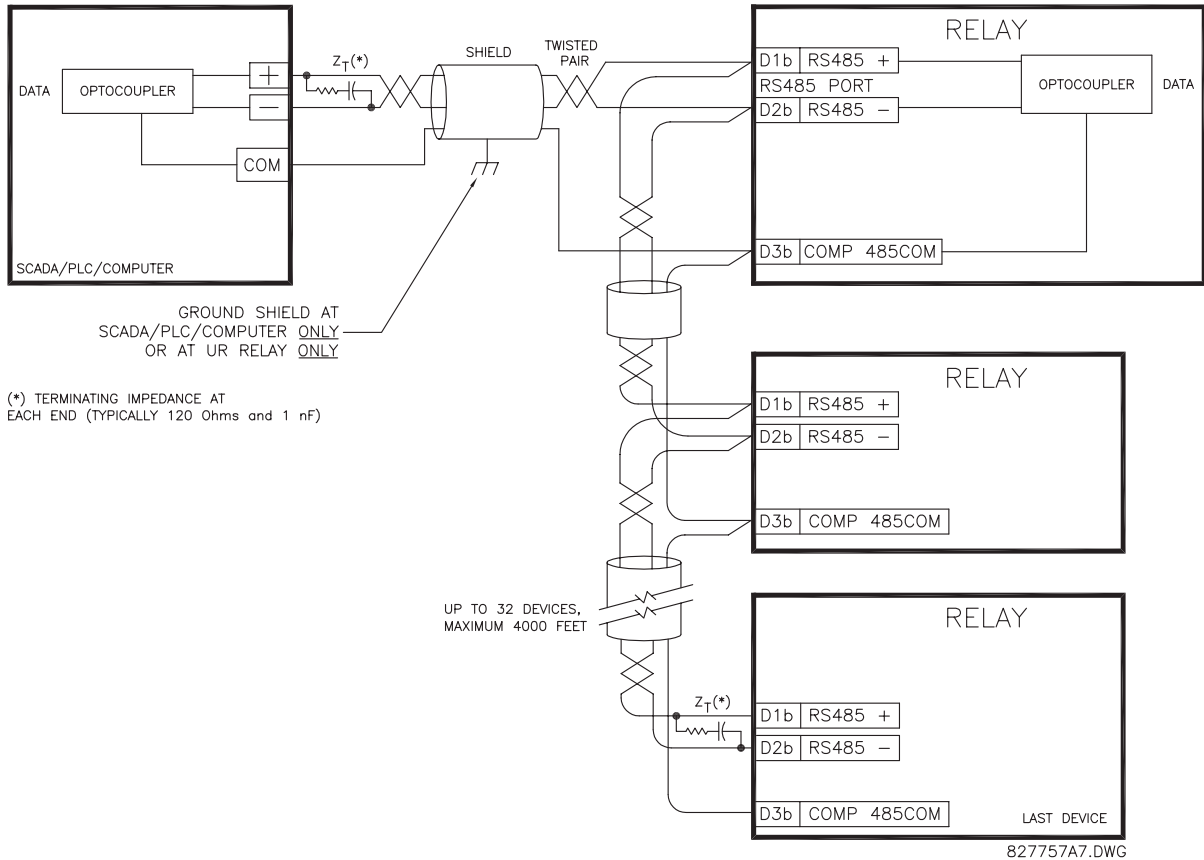

Figure 3-19: RS485 SERIAL CONNECTION

c) 10BASE-F FIBER OPTIC PORT



ENSURE THE DUST COVERS ARE INSTALLED WHEN THE FIBER IS NOT IN USE. DIRTY OR SCRATCHED CONNECTORS CAN LEAD TO HIGH LOSSES ON A FIBER LINK.

OBSERVING ANY FIBER TRANSMITTER OUTPUT MAY CAUSE INJURY TO THE EYE.

The fiber optic communication ports allow for fast and efficient communications between relays at 10 Mbps. Optical fiber may be connected to the relay supporting a wavelength of 820 nanometers in multimode. Optical fiber is only available for CPU types 9G and 9H. The 9H CPU has a 10BaseF transmitter and receiver for optical fiber communications and a second pair of identical optical fiber transmitter and receiver for redundancy.

The optical fiber sizes supported include 50/125 μm, 62.5/125 μm and 100/140 μm. The fiber optic port is designed such that the response times will not vary for any core that is 100 μm or less in diameter. For optical power budgeting, splices are required every 1 km for the transmitter/receiver pair (the ST type connector contributes for a connector loss of 0.2 dB). When splicing optical fibers, the diameter and numerical aperture of each fiber must be the same. In order to engage or disengage the ST type connector, only a quarter turn of the coupling is required.

3.2.9 IRIG-B

IRIG-B is a standard time code format that allows stamping of events to be synchronized among connected devices within 1 millisecond. The IRIG time code formats are serial, width-modulated codes which can be either DC level shifted or amplitude modulated (AM). Third party equipment is available for generating the IRIG-B signal; this equipment may use a GPS satellite system to obtain the time reference so that devices at different geographic locations can also be synchronized.

3

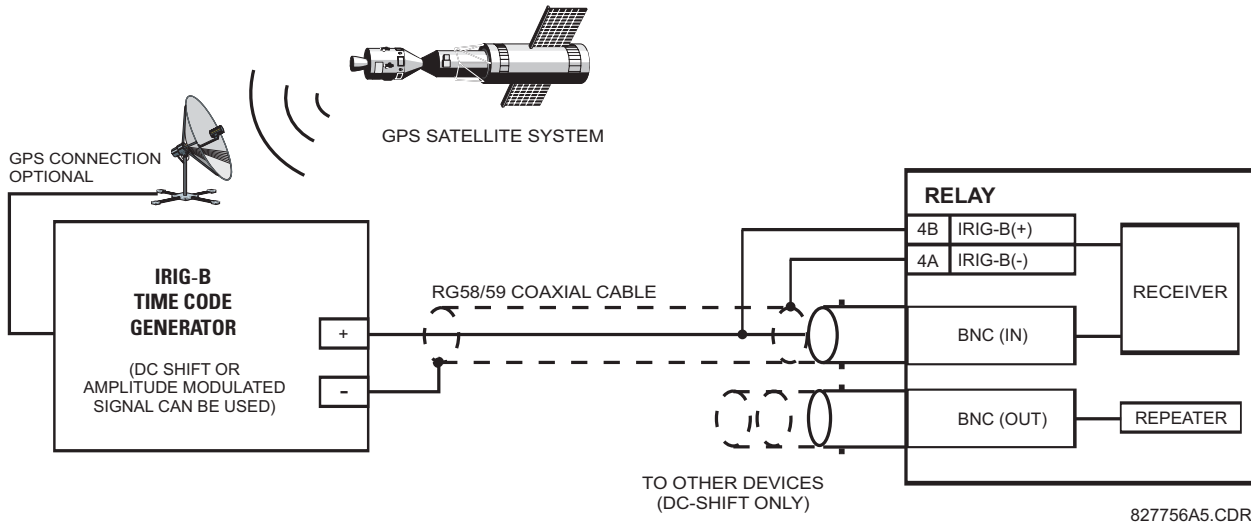

Figure 3-20: IRIG-B CONNECTION

The IRIG-B repeater provides an amplified DC-shift IRIG-B signal to other equipment. By using one IRIG-B serial connection, several UR-series relays can be synchronized. The IRIG-B repeater has a bypass function to maintain the time signal even when a relay in the series is powered down.

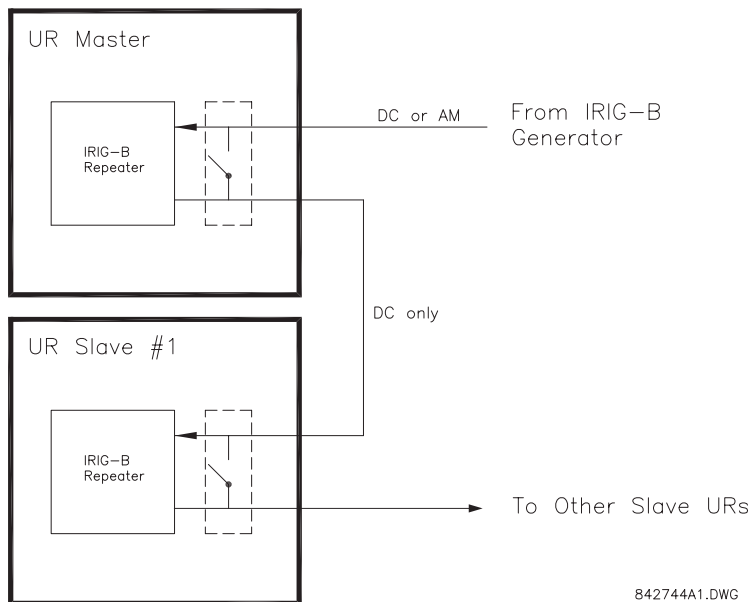

Figure 3-21: IRIG-B REPEATER

3.3.1 DESCRIPTION

The F35 direct inputs/outputs feature makes use of the Type 7 series of communications modules. These modules are also used by the L90 Line Differential Relay for inter-relay communications. The direct input/output feature uses the communications channel(s) provided by these modules to exchange digital state information between relays. This feature is available on all UR-series relay models except for the L90 Line Differential relay.

The communications channels are normally connected in a ring configuration as shown below. The transmitter of one module is connected to the receiver of the next module. The transmitter of this second module is then connected to the receiver of the next module in the ring. This is continued to form a communications ring. The figure below illustrates a ring of four UR-series relays with the following connections: UR1-Tx to UR2-Rx, UR2-Tx to UR3-Rx, UR3-Tx to UR4-Rx, and UR4-Tx to UR1-Rx. A maximum of eight (8) UR-series relays can be connected in a single ring

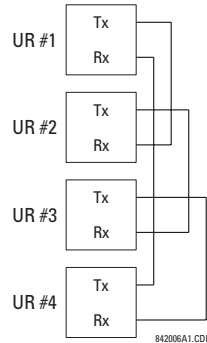

Figure 3–22: DIRECT INPUT/OUTPUT SINGLE CHANNEL CONNECTION

The interconnection for dual-channel Type 7 communications modules is shown below. Two channel modules allow for a redundant ring configuration. That is, two rings can be created to provide an additional independent data path. The required connections are: UR1-Tx1 to UR2-Rx1, UR2-Tx1 to UR3-Rx1, UR3-Tx1 to UR4-Rx1, and UR4-Tx1 to UR1-Rx1 for the first ring; and UR1-Tx2 to UR2-Rx2, UR2-Tx2 to UR3-Rx2, UR3-Tx2 to UR4-Rx2, and UR4-Tx2 to UR1-Rx2 for the second ring.

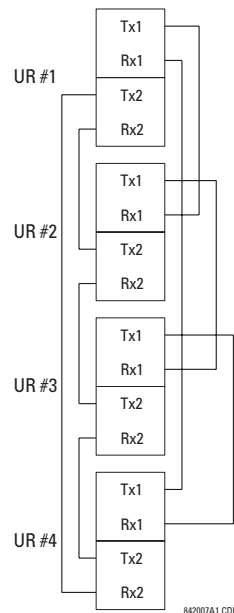

Figure 3–23: DIRECT INPUT/OUTPUT DUAL CHANNEL CONNECTION

The following diagram shows the connection for three UR-series relays using two independent communication channels. UR1 and UR3 have single Type 7 communication modules; UR2 has a dual-channel module. The two communication channels can be of different types, depending on the Type 7 modules used. To allow the direct input/output data to 'cross-over' from Channel 1 to Channel 2 on UR2, the **DIRECT I/O CHANNEL CROSSOVER** setting should be "Enabled" on UR2. This forces UR2 to forward messages received on Rx1 out Tx2, and messages received on Rx2 out Tx1.

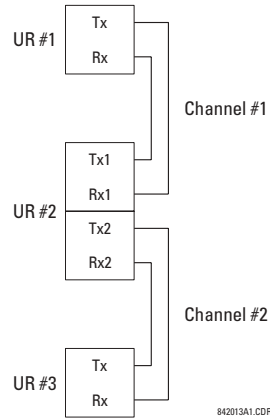

Figure 3–24: DIRECT INPUT/OUTPUT SINGLE/DUAL CHANNEL COMBINATION CONNECTION

The interconnection requirements are described in further detail in this section for each specific variation of Type 7 communications module. These modules are listed in the following table. All fiber modules use ST type connectors.

Table 3–3: CHANNEL COMMUNICATION OPTIONS

MODULE	SPECIFICATION
2A	C37.94SM, 1300 nm, single-mode, ELED, 1 channel single-mode
2B	C37.94SM, 1300 nm, single-mode, ELED, 2 channel single-mode
7A	820 nm, multi-mode, LED, 1 channel
7B	1300 nm, multi-mode, LED, 1 channel
7C	1300 nm, single-mode, ELED, 1 channel
7D	1300 nm, single-mode, LASER, 1 channel
7E	Channel 1: G.703, Channel 2: 820 nm, multi-mode
7F	Channel 1: G.703, Channel 2: 1300 nm, multi-mode
7G	Channel 1: G.703, Channel 2: 1300 nm, single-mode ELED
7H	820 nm, multi-mode, LED, 2 channels
7I	1300 nm, multi-mode, LED, 2 channels
7J	1300 nm, single-mode, ELED, 2 channels
7K	1300 nm, single-mode, LASER, 2 channels
7L	Channel 1: RS422, Channel: 820 nm, multi-mode, LED
7M	Channel 1: RS422, Channel 2: 1300 nm, multi-mode, LED
7N	Channel 1: RS422, Channel 2: 1300 nm, single-mode, ELED
7P	Channel 1: RS422, Channel 2: 1300 nm, single-mode, LASER
7Q	Channel 1: G.703, Channel 2: 1300 nm, single-mode, LASER
7R	G.703, 1 channel
7S	G.703, 2 channels
7T	RS422, 1 channel
7W	RS422, 2 channels
72	1550 nm, single-mode, LASER, 1 channel
73	1550 nm, single-mode, LASER, 2 channels
74	Channel 1 - RS422; Channel 2 - 1550 nm, single-mode, LASER
75	Channel 1 - G.703; Channel 2 - 1550 nm, single-mode, LASER
76	IEEE C37.94, 820 nm, multi-mode, LED, 1 channel
77	IEEE C37.94, 820 nm, multi-mode, LED, 2 channels



OBSERVING ANY FIBER TRANSMITTER OUTPUT MAY CAUSE INJURY TO THE EYE.

3.3.2 FIBER: LED AND ELED TRANSMITTERS

The following figure shows the configuration for the 7A, 7B, 7C, 7H, 7I, and 7J fiber-only modules.

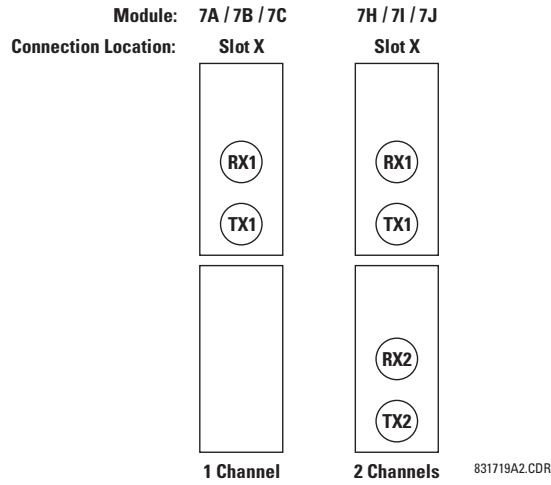

Figure 3–25: LED AND ELED FIBER MODULES

3.3.3 FIBER-LASER TRANSMITTERS

The following figure shows the configuration for the 72, 73, 7D, and 7K fiber-laser module.

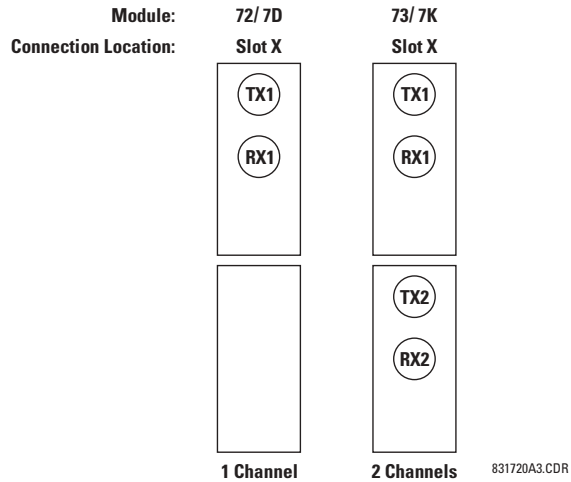

Figure 3–26: LASER FIBER MODULES



When using a LASER Interface, attenuators may be necessary to ensure that you do not exceed Maximum Optical Input Power to the receiver.

a) DESCRIPTION

The following figure shows the 64K ITU G.703 co-directional interface configuration.



The G.703 module is fixed at 64 kbps only. The SETTINGS ⇒ PRODUCT SETUP ⇒ DIRECT I/O ⇒ DIRECT I/O DATA RATE setting is not applicable to this module.

NOTE

AWG 22 twisted shielded pair is recommended for external connections, with the shield grounded only at one end. Connecting the shield to Pin X1a or X6a grounds the shield since these pins are internally connected to ground. Thus, if Pin X1a or X6a is used, do not ground at the other end. This interface module is protected by surge suppression devices.

7R	G.703 CHANNEL 1	Shld.	X1a
		Tx -	X1b
		Rx -	X2a
		Tx +	X2b
		Rx +	X3a
	SURGE	⏏	X3b
	G.703 CHANNEL 2	Shld.	X6a
		Tx -	X6b
		Rx -	X7a
		Tx +	X7b
Rx +		X8a	
SURGE	⏏	X8b	

831727A2-X1.CDR

Figure 3-27: G.703 INTERFACE CONFIGURATION

The following figure shows the typical pin interconnection between two G.703 interfaces. For the actual physical arrangement of these pins, see the Rear Terminal Assignments section earlier in this chapter. All pin interconnections are to be maintained for a connection to a multiplexer.

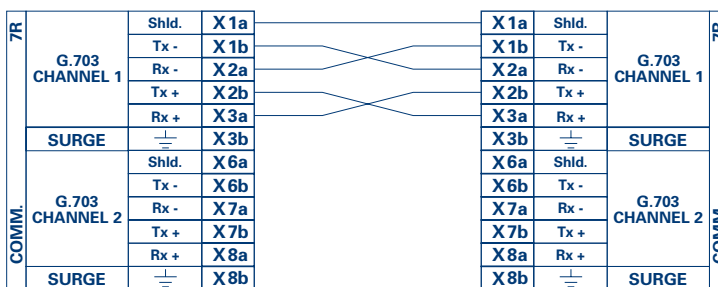

831727A2.CDR

Figure 3-28: TYPICAL PIN INTERCONNECTION BETWEEN TWO G.703 INTERFACES



Pin nomenclature may differ from one manufacturer to another. Therefore, it is not uncommon to see pinouts numbered TxA, TxB, RxA and RxB. In such cases, it can be assumed that “A” is equivalent to “+” and “B” is equivalent to “-”.

NOTE

b) G.703 SELECTION SWITCH PROCEDURES

1. Remove the G.703 module (7R or 7S):

The ejector/insertor clips located at the top and at the bottom of each module, must be pulled simultaneously in order to release the module for removal. Before performing this action, **control power must be removed from the relay**. The original location of the module should be recorded to help ensure that the same or replacement module is inserted into the correct slot.

2. Remove the module cover screw.
3. Remove the top cover by sliding it towards the rear and then lift it upwards.
4. Set the Timing Selection Switches (Channel 1, Channel 2) to the desired timing modes.
5. Replace the top cover and the cover screw.

6. Re-insert the G.703 module. Take care to ensure that the **correct** module type is inserted into the **correct** slot position. The ejector/insertor clips located at the top and at the bottom of each module must be in the disengaged position as the module is smoothly inserted into the slot. Once the clips have cleared the raised edge of the chassis, engage the clips simultaneously. When the clips have locked into position, the module will be fully inserted.

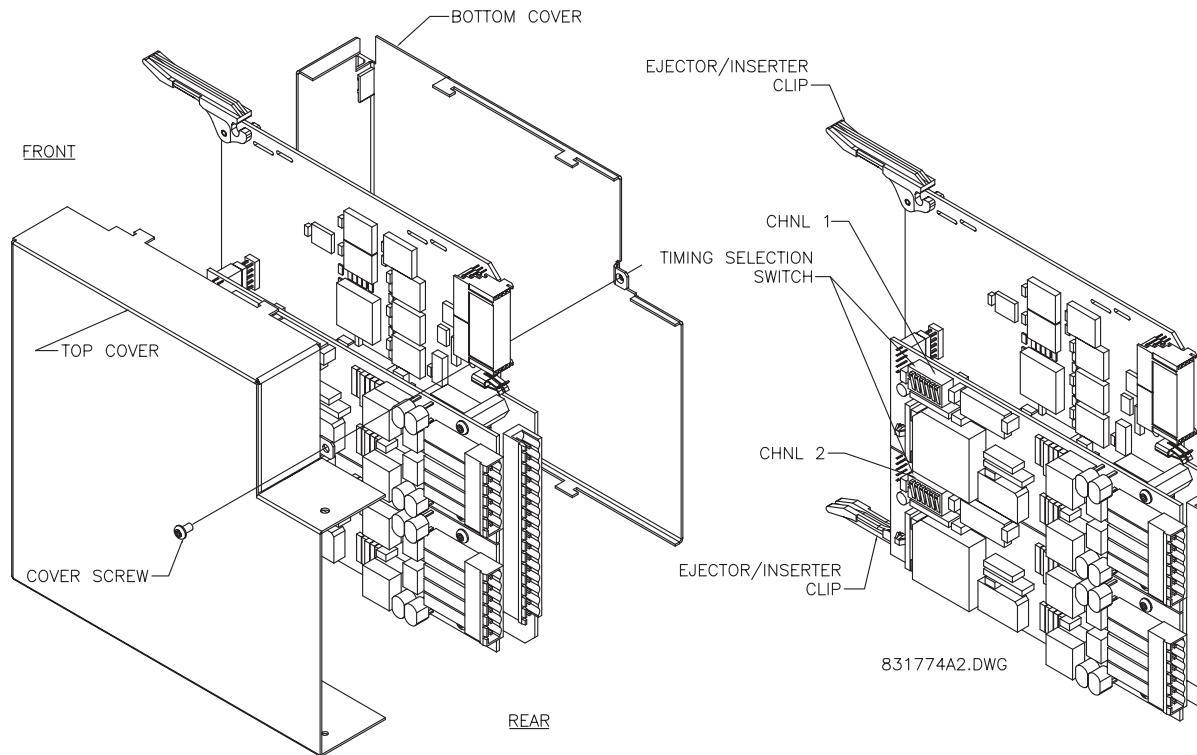

Figure 3–29: G.703 TIMING SELECTION SWITCH SETTING

Table 3–4: G.703 TIMING SELECTIONS

SWITCHES	FUNCTION
S1	OFF → Octet Timing Disabled ON → Octet Timing 8 kHz
S5 and S6	S5 = OFF and S6 = OFF → Loop Timing Mode S5 = ON and S6 = OFF → Internal Timing Mode S5 = OFF and S6 = ON → Minimum Remote Loopback Mode S5 = ON and S6 = ON → Dual Loopback Mode

c) OCTET TIMING (SWITCH S1)

If Octet Timing is enabled (ON), this 8 kHz signal will be asserted during the violation of Bit 8 (LSB) necessary for connecting to higher order systems. When F35s are connected back to back, Octet Timing should be disabled (OFF).

d) TIMING MODES (SWITCHES S5 AND S6)

- **Internal Timing Mode:** The system clock generated internally. Therefore, the G.703 timing selection should be in the Internal Timing Mode for back-to-back (UR-to-UR) connections. For Back to Back Connections, set for Octet Timing (S1 = OFF) and Timing Mode = Internal Timing (S5 = ON and S6 = OFF).
- **Loop Timing Mode:** The system clock is derived from the received line signal. Therefore, the G.703 timing selection should be in Loop Timing Mode for connections to higher order systems. For connection to a higher order system (UR-to-multiplexer, factory defaults), set to Octet Timing (S1 = ON) and set Timing Mode = Loop Timing (S5 = OFF and S6 = OFF).

e) TEST MODES (SWITCHES S5 AND S6)

MINIMUM REMOTE LOOPBACK MODE:

In Minimum Remote Loopback mode, the multiplexer is enabled to return the data from the external interface without any processing to assist in diagnosing G.703 Line Side problems irrespective of clock rate. Data enters from the G.703 inputs, passes through the data stabilization latch which also restores the proper signal polarity, passes through the multiplexer and then returns to the transmitter. The Differential Received Data is processed and passed to the G.703 Transmitter module after which point the data is discarded. The G.703 Receiver module is fully functional and continues to process data and passes it to the Differential Manchester Transmitter module. Since timing is returned as it is received, the timing source is expected to be from the G.703 line side of the interface.

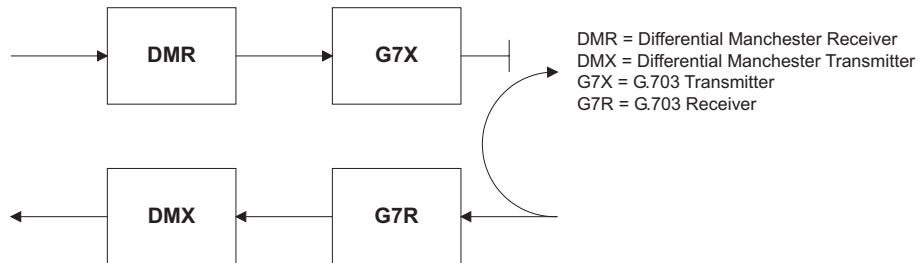
**DUAL LOOPBACK MODE:**

In Dual Loopback Mode, the multiplexers are active and the functions of the circuit are divided into two with each Receiver/Transmitter pair linked together to deconstruct and then reconstruct their respective signals. Differential Manchester data enters the Differential Manchester Receiver module and then is returned to the Differential Manchester Transmitter module. Likewise, G.703 data enters the G.703 Receiver module and is passed through to the G.703 Transmitter module to be returned as G.703 data. Because of the complete split in the communications path and because, in each case, the clocks are extracted and reconstructed with the outgoing data, in this mode there must be two independent sources of timing. One source lies on the G.703 line side of the interface while the other lies on the Differential Manchester side of the interface.

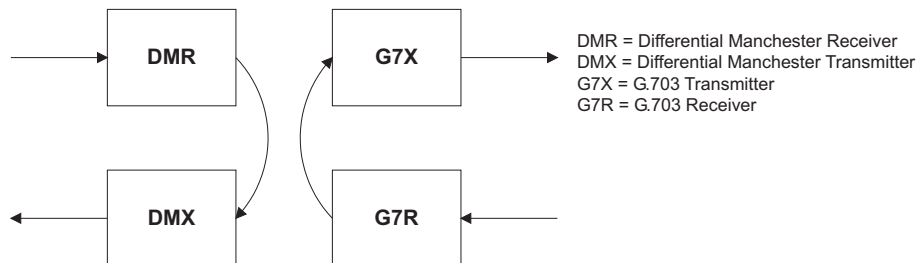
**3.3.5 RS422 INTERFACE****a) DESCRIPTION**

The following figure shows the RS422 2-terminal interface configuration at 64 kbps. AWG 22 twisted shielded pair is recommended for external connections. This interface module is protected by surge suppression devices which optically isolated.



The RS422 module is fixed at 64 kbps only. The SETTINGS ⇒ PRODUCT SETUP ⇒ DIRECT I/O ⇒ DIRECT I/O DATA RATE setting is not applicable to this module.

NOTE

SHIELD TERMINATION

The shield pins (6a and 7b) are internally connected to the ground pin (8a). Proper shield termination is as follows:

Site 1: Terminate shield to pins 6a and/or 7b; Site 2: Terminate shield to 'COM' pin 2b.

The clock terminating impedance should match the impedance of the line.

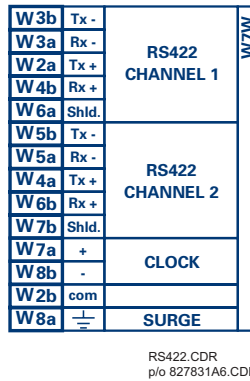

Figure 3–30: RS422 INTERFACE CONFIGURATION

The following figure shows the typical pin interconnection between two RS422 interfaces. All pin interconnections are to be maintained for a connection to a multiplexer.

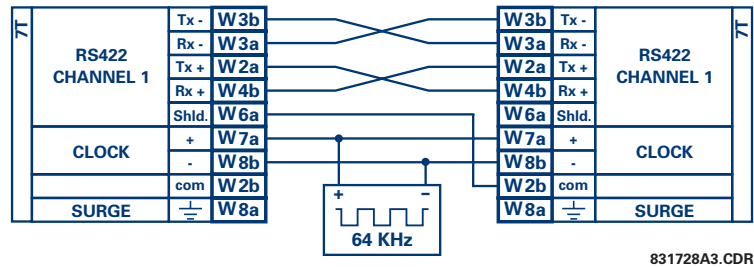
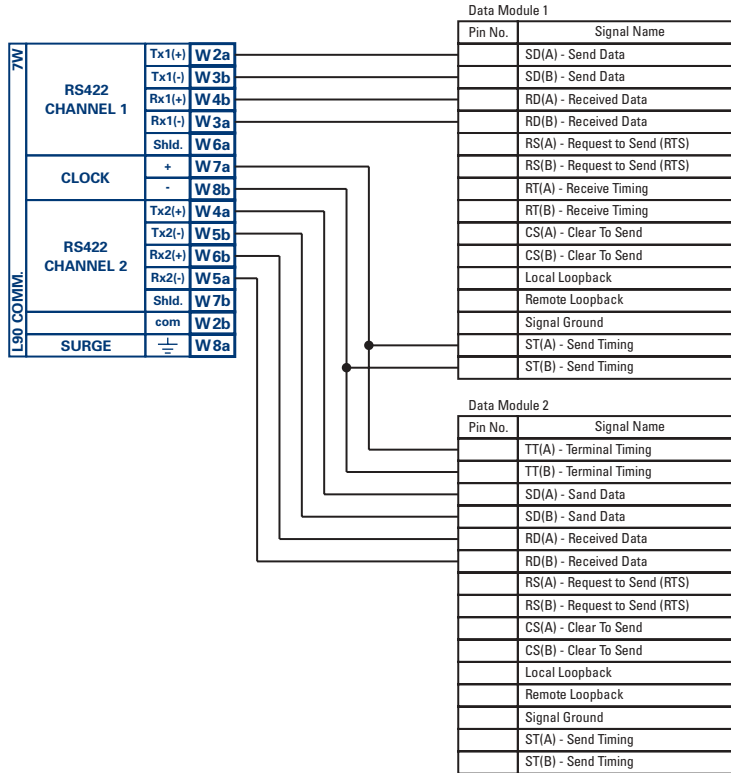

Figure 3–31: TYPICAL PIN INTERCONNECTION BETWEEN TWO RS422 INTERFACES

b) TWO CHANNEL APPLICATIONS VIA MULTIPLEXERS

The RS422 Interface may be used for ‘1 channel’ or ‘2 channel’ applications over SONET/SDH and/or Multiplexed systems. When used in 1 channel applications, the RS422 interface links to higher order systems in a typical fashion observing Tx, Rx, and Send Timing connections. However, when used in 2 channel applications, certain criteria have to be followed due to the fact that there is 1 clock input for the two RS422 channels. The system will function correctly if the following connections are observed and your Data Module has a feature called Terminal Timing. Terminal Timing is a common feature to most Synchronous Data Units that allows the module to accept timing from an external source. Using the Terminal Timing feature, 2 channel applications can be achieved if these connections are followed: The Send Timing outputs from the Multiplexer - Data Module 1, will connect to the Clock inputs of the UR–RS422 interface in the usual fashion. In addition, the Send Timing outputs of Data Module 1 will also be paralleled to the Terminal Timing inputs of Data Module 2. By using this configuration the timing for both Data Modules and both UR–RS422 channels will be derived from a single clock source. As a result, data sampling for both of the UR–RS422 channels will be synchronized via the Send Timing leads on Data Module 1 as shown in the following figure. If the Terminal Timing feature is not available or this type of connection is not desired, the G.703 interface is a viable option that does not impose timing restrictions.



831022A2.CDR

Figure 3–32: TIMING CONFIGURATION FOR RS422 TWO-CHANNEL, 3-TERMINAL APPLICATION

Data Module 1 provides timing to the F35 RS422 interface via the ST(A) and ST(B) outputs. Data Module 1 also provides timing to Data Module 2 TT(A) and TT(B) inputs via the ST(A) and AT(B) outputs. The Data Module pin numbers have been omitted in the figure above since they may vary depending on the manufacturer.

c) TRANSIT TIMING

The RS422 Interface accepts one clock input for Transmit Timing. It is important that the rising edge of the 64 kHz Transmit Timing clock of the Multiplexer Interface is sampling the data in the center of the Transmit Data window. Therefore, it is important to confirm Clock and Data Transitions to ensure Proper System Operation. For example, the following figure shows the positive edge of the Tx Clock in the center of the Tx Data bit.

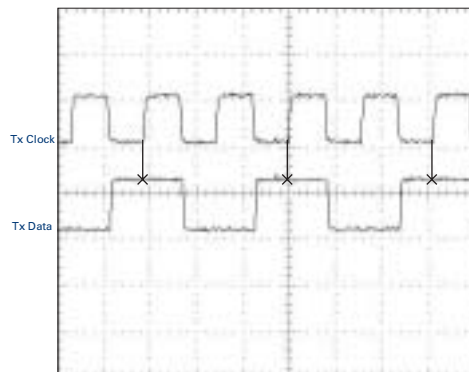

Figure 3–33: CLOCK AND DATA TRANSITIONS

d) RECEIVE TIMING

The RS422 Interface utilizes NRZI-MARK Modulation Code and; therefore, does not rely on an Rx Clock to recapture data. NRZI-MARK is an edge-type, invertible, self-clocking code.

To recover the Rx Clock from the data-stream, an integrated DPLL (Digital Phase Lock Loop) circuit is utilized. The DPLL is driven by an internal clock, which is over-sampled 16X, and uses this clock along with the data-stream to generate a data clock that can be used as the SCC (Serial Communication Controller) receive clock.

3.3.6 RS422 AND FIBER INTERFACE

The following figure shows the combined RS422 plus Fiber interface configuration at 64K baud. The 7L, 7M, 7N, 7P, and 74 modules are used in 2-terminal with a redundant channel or 3-terminal configurations where Channel 1 is employed via the RS422 interface (possibly with a multiplexer) and Channel 2 via direct fiber.

AWG 22 twisted shielded pair is recommended for external RS422 connections and the shield should be grounded only at one end. For the direct fiber channel, power budget issues should be addressed properly.



When using a LASER Interface, attenuators may be necessary to ensure that you do not exceed Maximum Optical Input Power to the receiver.

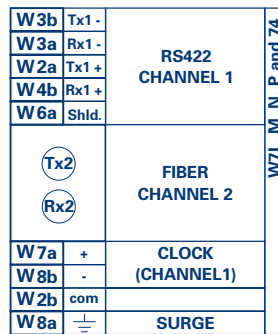

L907LMNP.CDR
P/O 827831A6.CDR

Figure 3–34: RS422 AND FIBER INTERFACE CONNECTION

Connections shown above are for multiplexers configured as DCE (Data Communications Equipment) units.

3.3.7 G.703 AND FIBER INTERFACE

The figure below shows the combined G.703 plus Fiber interface configuration at 64K baud. The 7E, 7F, 7G, 7Q, and 75 modules are used in configurations where Channel 1 is employed via the G.703 interface (possibly with a multiplexer) and Channel 2 via direct fiber. AWG 22 twisted shielded pair is recommended for external G.703 connections connecting the shield to Pin 1A at one end only. For the direct fiber channel, power budget issues should be addressed properly. See previous sections for more details on the G.703 and Fiber interfaces.



When using a LASER Interface, attenuators may be necessary to ensure that you do not exceed Maximum Optical Input Power to the receiver.

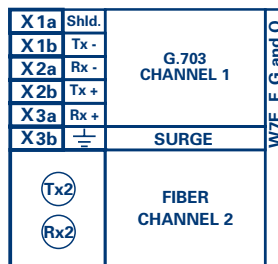

Figure 3–35: G.703 AND FIBER INTERFACE CONNECTION

3.3.8 IEEE C37.94 INTERFACE

The UR-series IEEE C37.94 communication modules (76 and 77) are designed to interface with IEEE C37.94 compliant digital multiplexers and/or an IEEE C37.94 compliant interface converter for use with direct input/output applications for firmware revisions 3.30 and higher. The IEEE C37.94 standard defines a point-to-point optical link for synchronous data between a multiplexer and a teleprotection device. This data is typically 64 kbps, but the standard provides for speeds up to $64n$ kbps, where $n = 1, 2, \dots, 12$. The UR-series C37.94 communication module is 64 kbps only with n fixed at 1. The frame is a valid International Telecommunications Union (ITU-T) recommended G.704 pattern from the standpoint of framing and data rate. The frame is 256 bits and is repeated at a frame rate of 8000 Hz, with a resultant bit rate of 2048 kbps.

The specifications for the module are as follows:

- IEEE standard: C37.94 for 1×64 kbps optical fiber interface
- Fiber optic cable type: 50 mm or 62.5 mm core diameter optical fiber
- Fiber optic mode: multi-mode
- Fiber optic cable length: up to 2 km
- Fiber optic connector: type ST
- Wavelength: 830 ± 40 nm
- Connection: as per all fiber optic connections, a Tx to Rx connection is required.

The UR-series C37.94 communication module can be connected directly to any compliant digital multiplexer that supports the IEEE C37.94 standard as shown below.

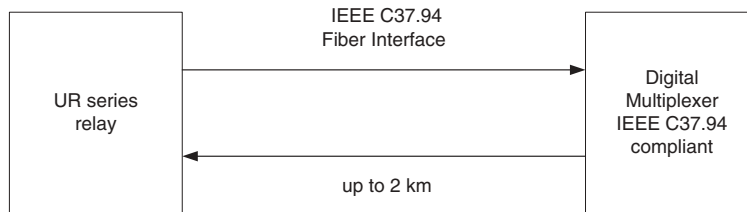

The UR-series C37.94 communication module can be connected to the electrical interface (G.703, RS422, or X.21) of a non-compliant digital multiplexer via an optical-to-electrical interface converter that supports the IEEE C37.94 standard, as shown below.

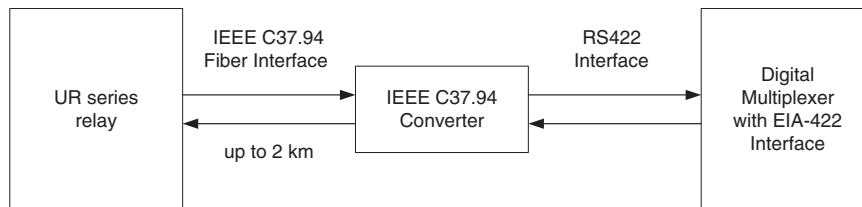

The UR-series C37.94 communication module has six (6) switches that are used to set the clock configuration. The functions of these control switches is shown below.

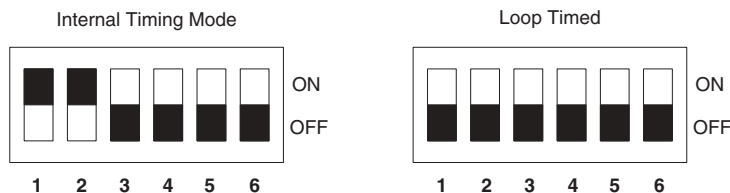

Switch	Internal	Loop Timed
1	ON	OFF
2	ON	OFF
3	OFF	OFF
4	OFF	OFF
5	OFF	OFF
6	OFF	OFF

For the Internal Timing Mode, the system clock is generated internally. Therefore, the timing switch selection should be Internal Timing for Relay 1 and Loop Timed for Relay 2. There must be only one timing source configured.

For the Looped Timing Mode, the system clock is derived from the received line signal. Therefore, the timing selection should be in Loop Timing Mode for connections to higher order systems.

The C37.94 communications module cover removal procedure is as follows:

1. Remove the C37.94 module (76 or 77):

The ejector/inserter clips located at the top and at the bottom of each module, must be pulled simultaneously in order to release the module for removal. Before performing this action, **control power must be removed from the relay**. The original location of the module should be recorded to help ensure that the same or replacement module is inserted into the correct slot.

2. Remove the module cover screw.
3. Remove the top cover by sliding it towards the rear and then lift it upwards.
4. Set the Timing Selection Switches (Channel 1, Channel 2) to the desired timing modes (see description above).
5. Replace the top cover and the cover screw.
6. Re-insert the C37.94 module. Take care to ensure that the **correct** module type is inserted into the **correct** slot position. The ejector/inserter clips located at the top and at the bottom of each module must be in the disengaged position as the module is smoothly inserted into the slot. Once the clips have cleared the raised edge of the chassis, engage the clips simultaneously. When the clips have locked into position, the module will be fully inserted.

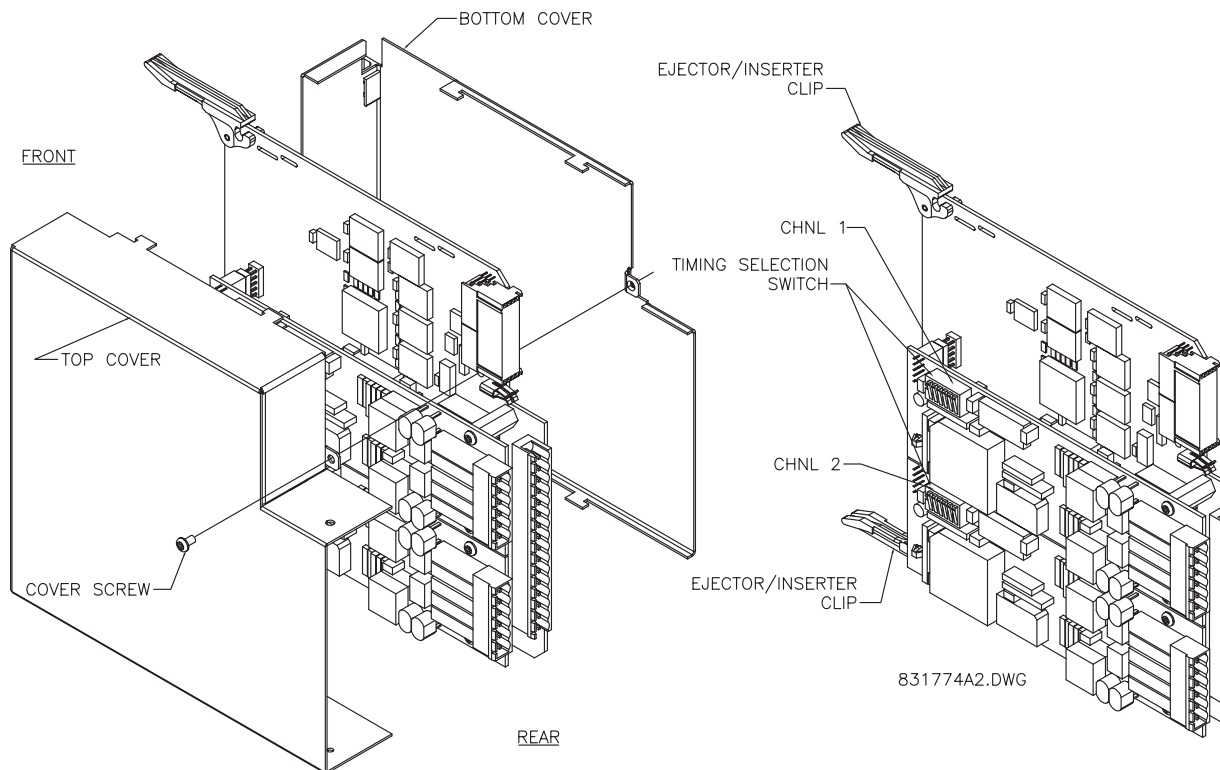

Figure 3–36: C37.94 TIMING SELECTION SWITCH SETTING

4.1.1 INTRODUCTION

The enerVista UR Setup software provides a graphical user interface (GUI) as one of two human interfaces to a UR device. The alternate human interface is implemented via the device's faceplate keypad and display (see Faceplate Interface section in this chapter).

The enerVista UR Setup software provides a single facility to configure, monitor, maintain, and trouble-shoot the operation of relay functions, connected over local or wide area communication networks. It can be used while disconnected (i.e. off-line) or connected (i.e. on-line) to a UR device. In off-line mode, settings files can be created for eventual downloading to the device. In on-line mode, you can communicate with the device in real-time.

The enerVista UR Setup software, provided with every F35 relay, can be run from any computer supporting Microsoft Windows® 95, 98, NT, 2000, ME, and XP. This chapter provides a summary of the basic enerVista UR Setup software interface features. The enerVista UR Setup Help File provides details for getting started and using the enerVista UR Setup software interface.

4.1.2 CREATING A SITE LIST

To start using the enerVista UR Setup software, a site definition and device definition must first be created. See the enerVista UR Setup Help File or refer to the *Connecting enerVista UR Setup with the F35* section in Chapter 1 for details.

4.1.3 ENERVISTA UR SETUP SOFTWARE OVERVIEW**a) ENGAGING A DEVICE**

The enerVista UR Setup software may be used in on-line mode (relay connected) to directly communicate with a UR relay. Communicating relays are organized and grouped by communication interfaces and into sites. Sites may contain any number of relays selected from the UR product series.

b) USING SETTINGS FILES

The enerVista UR Setup software interface supports three ways of handling changes to relay settings:

- In off-line mode (relay disconnected) to create or edit relay settings files for later download to communicating relays.
- While connected to a communicating relay to directly modify any relay settings via relay data view windows, and then save the settings to the relay.
- You can create/edit settings files and then write them to the relay while the interface is connected to the relay.

Settings files are organized on the basis of file names assigned by the user. A settings file contains data pertaining to the following types of relay settings:

- Device Definition
- Product Setup
- System Setup
- FlexLogic™
- Grouped Elements
- Control Elements
- Inputs/Outputs
- Testing

Factory default values are supplied and can be restored after any changes.

c) CREATING AND EDITING FLEXLOGIC™

You can create or edit a FlexLogic™ equation in order to customize the relay. You can subsequently view the automatically generated logic diagram.

d) VIEWING ACTUAL VALUES

You can view real-time relay data such as input/output status and measured parameters.

e) VIEWING TRIGGERED EVENTS

While the interface is in either on-line or off-line mode, you can view and analyze data generated by triggered specified parameters, via one of the following:

- **Event Recorder facility:** The event recorder captures contextual data associated with the last 1024 events, listed in chronological order from most recent to oldest.
- **Oscillography facility:** The oscillography waveform traces and digital states are used to provide a visual display of power system and relay operation data captured during specific triggered events.

f) FILE SUPPORT

- **Execution:** Any enerVista UR Setup file which is double clicked or opened will launch the application, or provide focus to the already opened application. If the file was a settings file (has a `URS` extension) which had been removed from the Settings List tree menu, it will be added back to the Settings List tree menu.
- **Drag and Drop:** The Site List and Settings List control bar windows are each mutually a drag source and a drop target for device-order-code-compatible files or individual menu items. Also, the Settings List control bar window and any Windows Explorer directory folder are each mutually a file drag source and drop target.

New files which are dropped into the Settings List window are added to the tree which is automatically sorted alphabetically with respect to settings file names. Files or individual menu items which are dropped in the selected device menu in the Site List window will automatically be sent to the on-line communicating device.

g) FIRMWARE UPGRADES

The firmware of a F35 device can be upgraded, locally or remotely, via the enerVista UR Setup software. The corresponding instructions are provided by the enerVista UR Setup Help file under the topic “Upgrading Firmware”.



Modbus addresses assigned to firmware modules, features, settings, and corresponding data items (i.e. default values, minimum/maximum values, data type, and item size) may change slightly from version to version of firmware. The addresses are rearranged when new features are added or existing features are enhanced or modified. The **EEPROM DATA ERROR** message displayed after upgrading/downgrading the firmware is a resettable, self-test message intended to inform users that the Modbus addresses have changed with the upgraded firmware. This message does not signal any problems when appearing after firmware upgrades.

4.1.4 ENERVISTA UR SETUP SOFTWARE MAIN WINDOW

The enerVista UR Setup software main window supports the following primary display components:

- Title bar which shows the pathname of the active data view
- Main window menu bar
- Main window tool bar
- Site List control bar window
- Settings List control bar window
- Device data view window(s), with common tool bar
- Settings File data view window(s), with common tool bar
- Workspace area with data view tabs
- Status bar

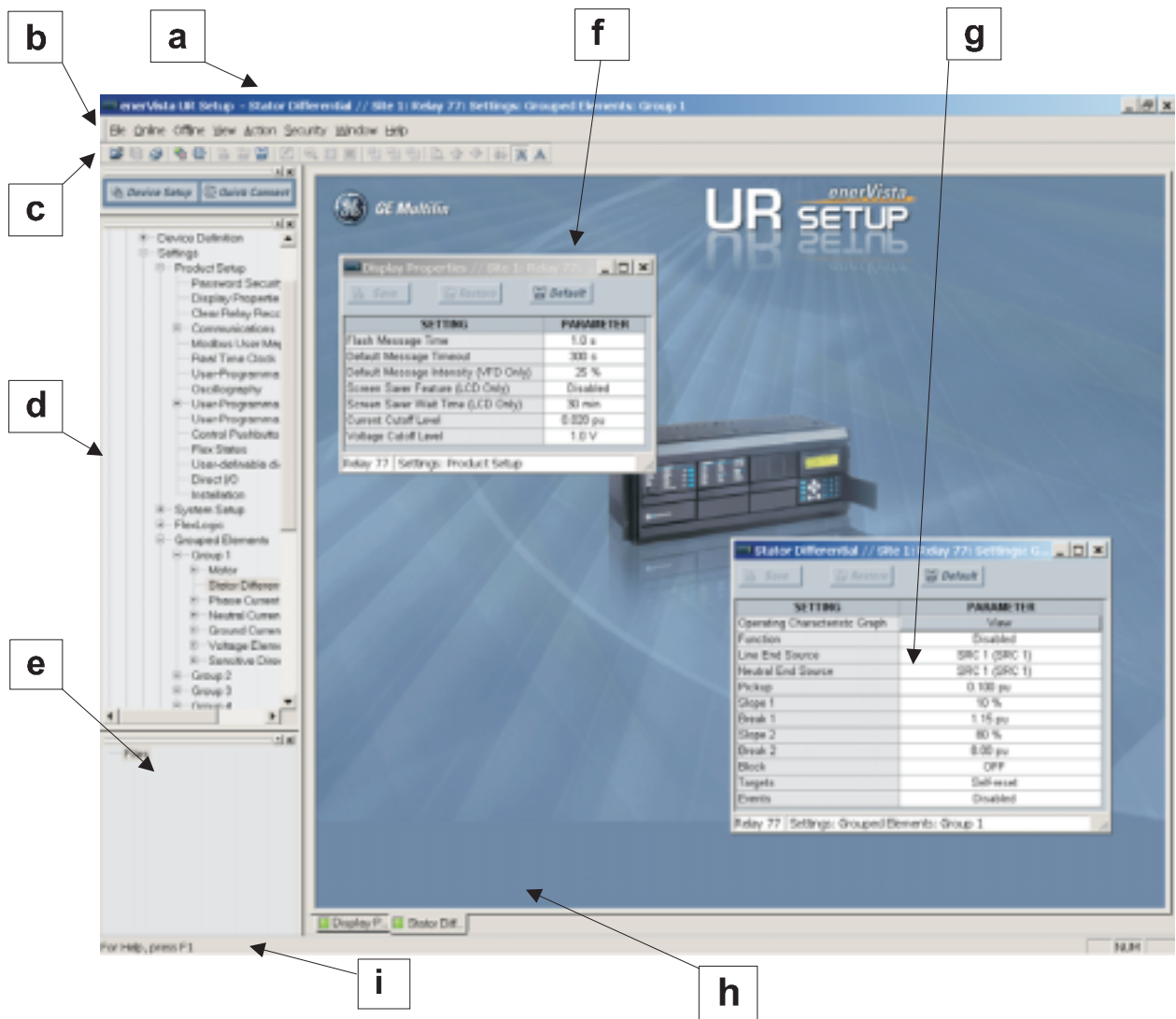

Figure 4-1: ENERVISTA UR SETUP SOFTWARE MAIN WINDOW

4.2.1 FACEPLATE

The keypad/display/LED interface is one of two alternate human interfaces supported. The other alternate human interface is implemented via the enerVista UR Setup software. The faceplate interface is available in two configurations: horizontal or vertical. The faceplate interface consists of several functional panels.

The faceplate is hinged to allow easy access to the removable modules. There is also a removable dust cover that fits over the faceplate which must be removed in order to access the keypad panel. The following two figures show the horizontal and vertical arrangement of faceplate panels.

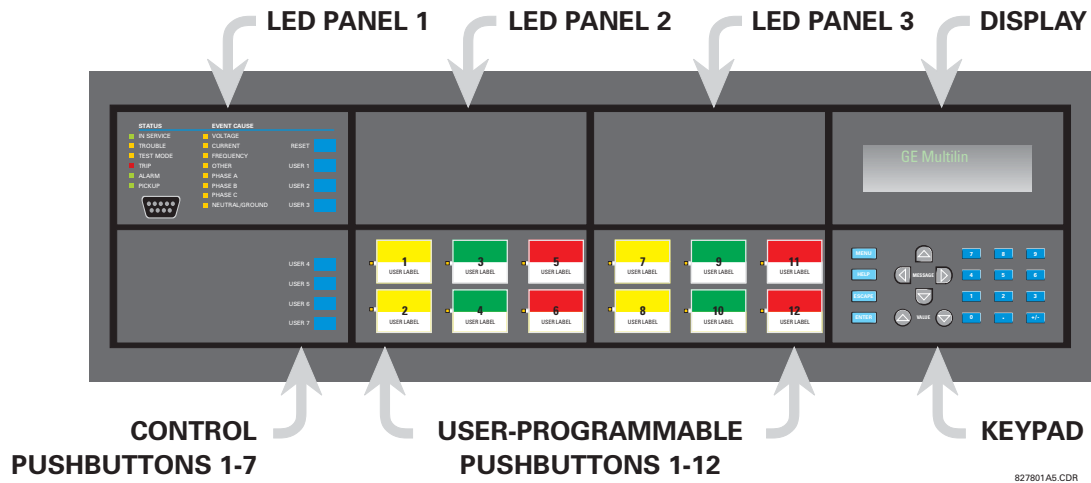

Figure 4-2: UR-SERIES HORIZONTAL FACEPLATE PANELS

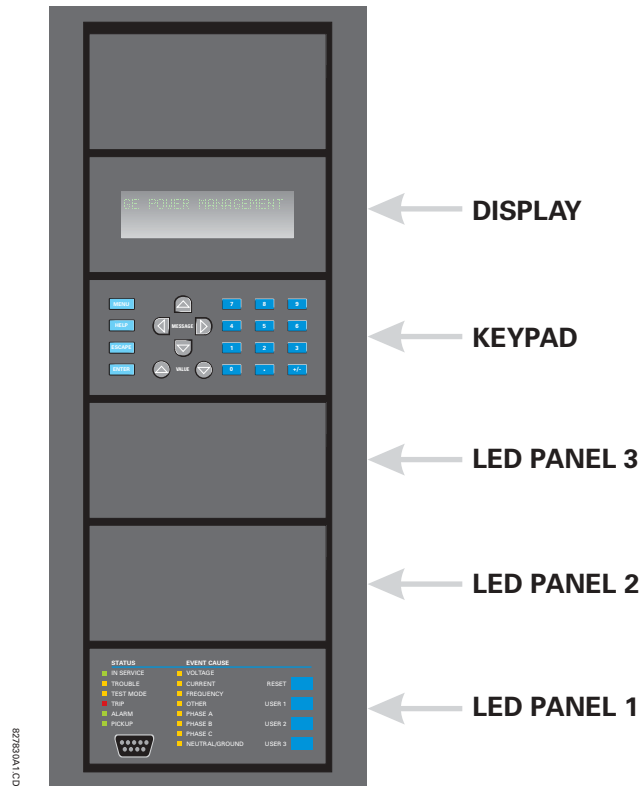

Figure 4-3: UR-SERIES VERTICAL FACEPLATE PANELS

4.2.2 LED INDICATORS

a) LED PANEL 1

This panel provides several LED indicators, several keys, and a communications port. The RESET key is used to reset any latched LED indicator or target message, once the condition has been cleared (these latched conditions can also be reset via the **SETTINGS** ⇒ **INPUT/OUTPUTS** ⇒ **RESETTING** menu). The USER keys are not used in this unit. The RS232 port is intended for connection to a portable PC.

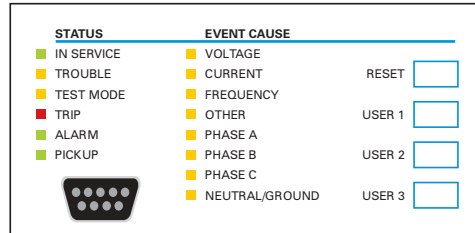

Figure 4-4: LED PANEL 1

STATUS INDICATORS:

- **IN SERVICE:** Indicates that control power is applied; all monitored inputs/outputs and internal systems are OK; the relay has been programmed.
- **TROUBLE:** Indicates that the relay has detected an internal problem.
- **TEST MODE:** Indicates that the relay is in test mode.
- **TRIP:** Indicates that the selected FlexLogic™ operand serving as a Trip switch has operated. This indicator always latches; the RESET command must be initiated to allow the latch to be reset.
- **ALARM:** Indicates that the selected FlexLogic™ operand serving as an Alarm switch has operated. This indicator is never latched.
- **PICKUP:** Indicates that an element is picked up. This indicator is never latched.

EVENT CAUSE INDICATORS:

These indicate the input type that was involved in a condition detected by an element that is operated or has a latched flag waiting to be reset.

- **VOLTAGE:** Indicates voltage was involved.
- **CURRENT:** Indicates current was involved.
- **FREQUENCY:** Indicates frequency was involved.
- **OTHER:** Indicates a composite function was involved.
- **PHASE A:** Indicates Phase A was involved.
- **PHASE B:** Indicates Phase B was involved.
- **PHASE C:** Indicates Phase C was involved.
- **NEUTRAL/GROUND:** Indicates neutral or ground was involved.

b) LED PANELS 2 AND 3

These panels provide 48 amber LED indicators whose operation is controlled by the user. Support for applying a customized label beside every LED is provided.

User customization of LED operation is of maximum benefit in installations where languages other than English are used to communicate with operators. Refer to the User-Programmable LEDs section in Chapter 5 for the settings used to program the operation of the LEDs on these panels.

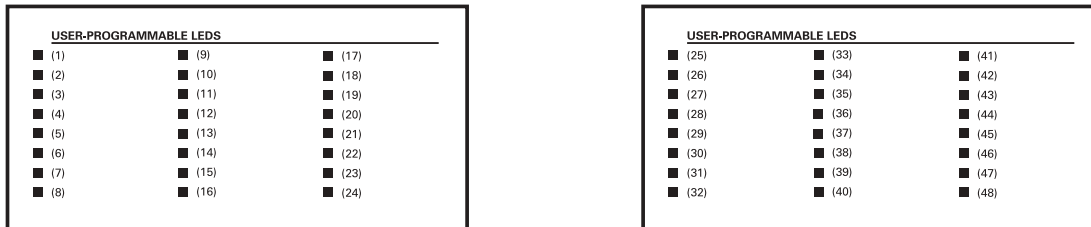

Figure 4-5: LED PANELS 2 AND 3 (INDEX TEMPLATE)

4

c) DEFAULT LABELS FOR LED PANEL 2

The default labels are intended to represent:

- **GROUP 1...6:** The illuminated GROUP is the active settings group.
- **BREAKER n OPEN:** The breaker is open.
- **BREAKER n CLOSED:** The breaker is closed.
- **BREAKER n TROUBLE:** A problem related to the breaker has been detected.
- **RECLOSE ENABLED:** The recloser is operational.
- **RECLOSE DISABLED:** The recloser is not operational.
- **RECLOSE IN PROGRESS:** A reclose operation is in progress.
- **RECLOSE LOCKED OUT:** The recloser is not operational and requires a reset.



Firmware revisions 2.9x and earlier support eight user setting groups; revisions 3.0x and higher support six setting groups. For convenience of users using earlier firmware revisions, the relay panel shows eight setting groups. Please note that the LEDs, despite their default labels, are fully user-programmable.

The relay is shipped with the default label for the LED panel 2. The LEDs, however, are not pre-programmed. To match the pre-printed label, the LED settings must be entered as shown in the *User-Programmable LEDs* section of Chapter 5. The LEDs are fully user-programmable. The default labels can be replaced by user-printed labels for both panels as explained in the following section.

SETTINGS IN USE	BREAKER 1	SYNCHROCHECK
GROUP 1	OPEN	NO1 IN-SYNCH
GROUP 2	CLOSED	NO2 IN-SYNCH
GROUP 3	TROUBLE	
GROUP 4		<u>RECLOSE</u>
GROUP 5	<u>BREAKER 2</u>	ENABLED
GROUP 6	OPEN	DISABLED
GROUP 7	CLOSED	IN PROGRESS
GROUP 8	TROUBLE	LOCKED OUT

Figure 4-6: LED PANEL 2 (DEFAULT LABELS)

d) CUSTOM LABELING OF LEDS

Custom labeling of an LED-only panel is facilitated through a Microsoft Word file available from the following URL:

<http://www.GEindustrial.com/multilin/support/ur/>

This file provides templates and instructions for creating appropriate labeling for the LED panel. The following procedures are contained in the downloadable file. The panel templates provide relative LED locations and located example text (x) edit boxes. The following procedure demonstrates how to install/uninstall the custom panel labeling.

1. Remove the clear Lexan Front Cover (GE Multilin Part Number: 1501-0014).



2. Pop out the LED Module and/or the Blank Module with a screwdriver as shown below. Be careful not to damage the plastic.

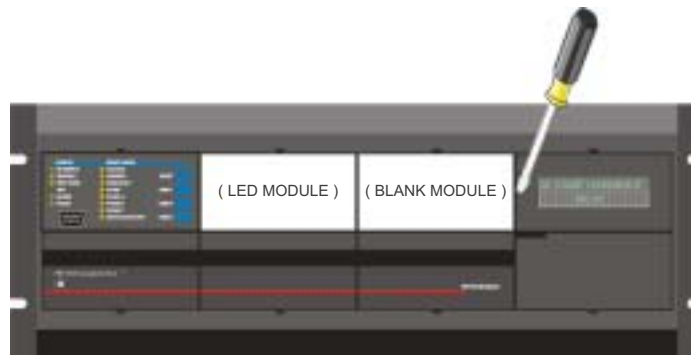

3. Place the left side of the customized module back to the front panel frame, then snap back the right side.
4. Put the clear Lexan Front Cover back into place.

e) CUSTOMIZING THE DISPLAY MODULE

The following items are required to customize the F35 display module:

- Black and white or color printer (color preferred).
 - Microsoft Word 97 or later software for editing the template.
 - 1 each of: 8.5" x 11" white paper, exacto knife, ruler, custom display module (GE Multilin Part Number: 1516-0069), and a custom module cover (GE Multilin Part Number: 1502-0015).
1. Open the LED panel customization template with Microsoft Word. Add text in places of the **LED x** text placeholders on the template(s). Delete unused place holders as required.
 2. When complete, save the Word file to your local PC for future use.
 3. Print the template(s) to a local printer.
 4. From the printout, cut-out the Background Template from the three windows, using the cropmarks as a guide.
 5. Put the Background Template on top of the custom display module (GE Multilin Part Number: 1513-0069) and snap the clear custom module cover (GE Multilin Part Number: 1502-0015) over it and the templates.

4.2.3 DISPLAY

All messages are displayed on a 2 × 20 character vacuum fluorescent display to make them visible under poor lighting conditions. An optional liquid crystal display (LCD) is also available. Messages are displayed in English and do not require the aid of an instruction manual for deciphering. While the keypad and display are not actively being used, the display will default to defined messages. Any high priority event driven message will automatically override the default message and appear on the display.

4.2.4 KEYPAD

Display messages are organized into 'pages' under the following headings: Actual Values, Settings, Commands, and Targets. The **MENU** key navigates through these pages. Each heading page is broken down further into logical subgroups.

The **▲** **◀** MESSAGE **▶** **▼** keys navigate through the subgroups. The **▲** VALUE **▼** keys scroll increment or decrement numerical setting values when in programming mode. These keys also scroll through alphanumeric values in the text edit mode. Alternatively, values may also be entered with the numeric keypad.

The **▶** key initiates and advance to the next character in text edit mode or enters a decimal point. The **HELP** key may be pressed at any time for context sensitive help messages. The **ENTER** key stores altered setting values.

4.2.5 MENUS

a) NAVIGATION

Press the **MENU** key to select the desired header display page (top-level menu). The header title appears momentarily followed by a header display page menu item. Each press of the **MENU** key advances through the main heading pages as illustrated below.

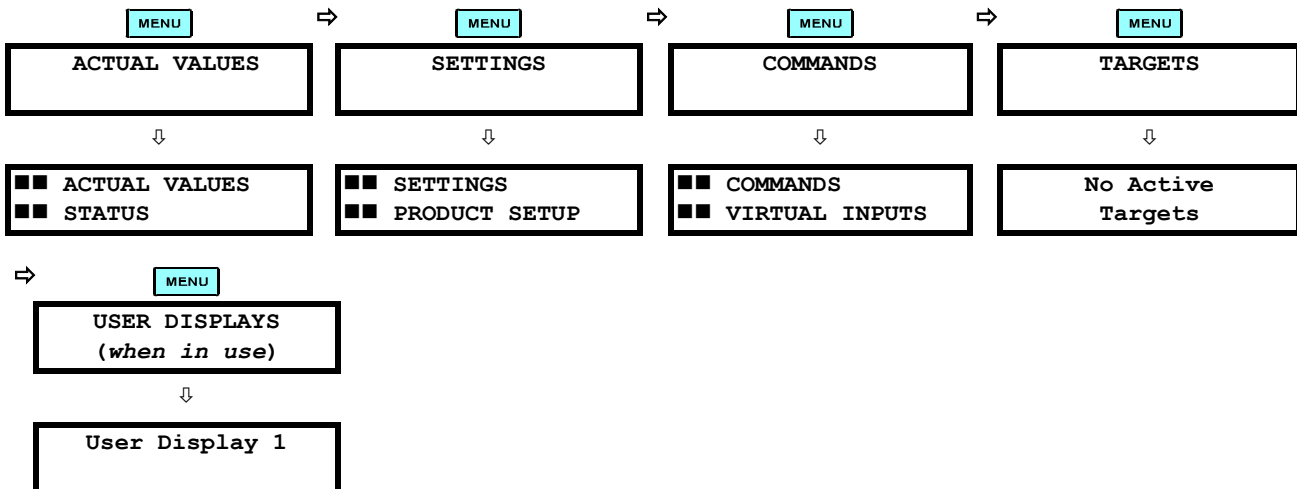

b) HIERARCHY

The setting and actual value messages are arranged hierarchically. The header display pages are indicated by double scroll bar characters (■■), while sub-header pages are indicated by single scroll bar characters (■). The header display pages represent the highest level of the hierarchy and the sub-header display pages fall below this level. The MESSAGE ▲ and ▼ keys move within a group of headers, sub-headers, setting values, or actual values. Continually pressing the MESSAGE ► key from a header display displays specific information for the header category. Conversely, continually pressing the ◀ MESSAGE key from a setting value or actual value display returns to the header display.

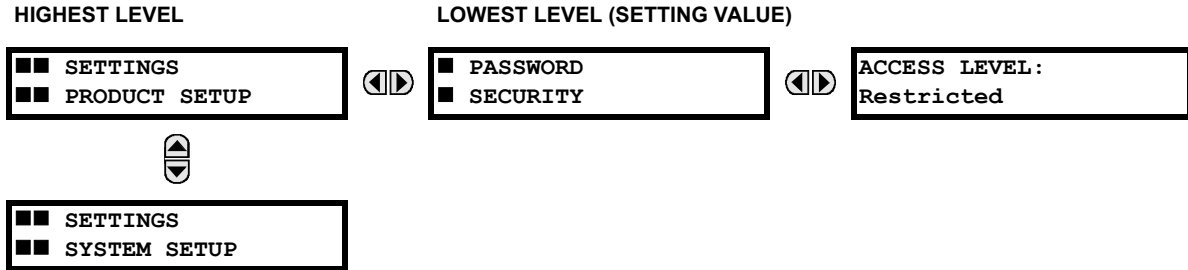

c) EXAMPLE MENU NAVIGATION

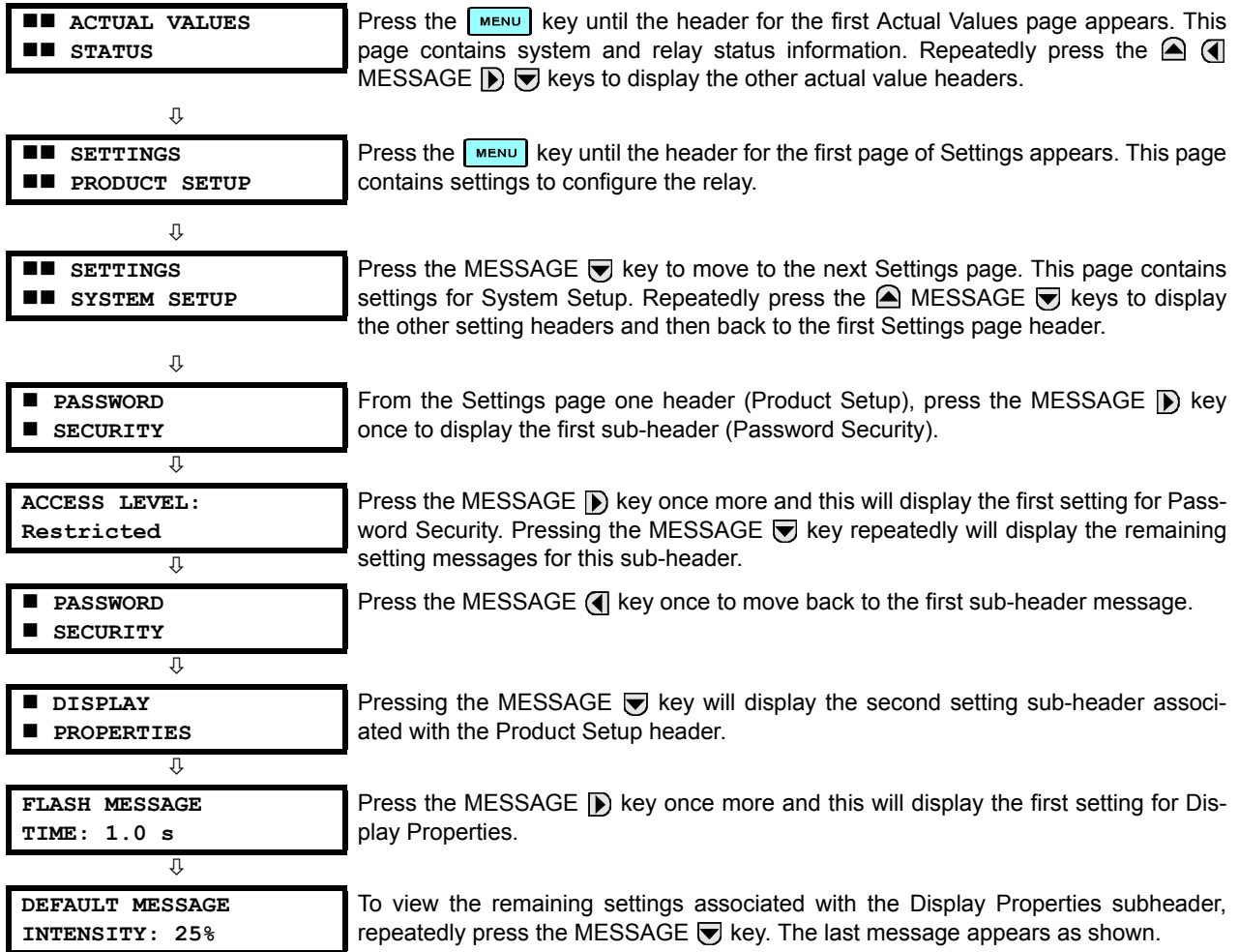

4.2.6 CHANGING SETTINGS

a) ENTERING NUMERICAL DATA

Each numerical setting has its own minimum, maximum, and increment value associated with it. These parameters define what values are acceptable for a setting.

FLASH MESSAGE
TIME: 1.0 s

For example, select the **SETTINGS** ⇒ **PRODUCT SETUP** ⇒ **DISPLAY PROPERTIES** ⇒ **FLASH MESSAGE TIME** setting.



MINIMUM: 0.5
MAXIMUM: 10.0

Press the **HELP** key to view the minimum and maximum values. Press the **HELP** key again to view the next context sensitive help message.

Two methods of editing and storing a numerical setting value are available.

- **0 to 9** and **.** (decimal point): The relay numeric keypad works the same as that of any electronic calculator. A number is entered one digit at a time. The leftmost digit is entered first and the rightmost digit is entered last. Pressing the MESSAGE key or pressing the ESCAPE key, returns the original value to the display.
- **VALUE** (▲▼): The VALUE (▲) key increments the displayed value by the step value, up to the maximum value allowed. While at the maximum value, pressing the VALUE (▲) key again will allow the setting selection to continue upward from the minimum value. The VALUE (▼) key decrements the displayed value by the step value, down to the minimum value. While at the minimum value, pressing the VALUE (▼) key again will allow the setting selection to continue downward from the maximum value.

FLASH MESSAGE
TIME: 2.5 s

As an example, set the flash message time setting to 2.5 seconds. Press the appropriate numeric keys in the sequence "2 . 5". The display message will change as the digits are being entered.



NEW SETTING
HAS BEEN STORED

Until **ENTER** is pressed, editing changes are not registered by the relay. Therefore, press **ENTER** to store the new value in memory. This flash message will momentarily appear as confirmation of the storing process. Numerical values which contain decimal places will be rounded-off if more decimal place digits are entered than specified by the step value.

b) ENTERING ENUMERATION DATA

Enumeration settings have data values which are part of a set, whose members are explicitly defined by a name. A set is comprised of two or more members.

ACCESS LEVEL:
Restricted

For example, the selections available for **ACCESS LEVEL** are "Restricted", "Command", "Setting", and "Factory Service".

Enumeration type values are changed using the VALUE keys. The VALUE (▲) key displays the next selection while the VALUE (▼) key displays the previous selection.

ACCESS LEVEL:
Setting

If the **ACCESS LEVEL** needs to be "Setting", press the VALUE keys until the proper selection is displayed. Press **HELP** at any time for the context sensitive help messages.



NEW SETTING
HAS BEEN STORED

Changes are not registered by the relay until the **ENTER** key is pressed. Pressing **ENTER** stores the new value in memory. This flash message momentarily appears as confirmation of the storing process.

c) ENTERING ALPHANUMERIC TEXT

Text settings have data values which are fixed in length, but user-defined in character. They may be comprised of upper case letters, lower case letters, numerals, and a selection of special characters.

There are several places where text messages may be programmed to allow the relay to be customized for specific applications. One example is the Message Scratchpad. Use the following procedure to enter alphanumeric text messages.

For example: to enter the text, "Breaker #1"

1. Press **•** to enter text edit mode.
2. Press the VALUE keys until the character 'B' appears; press **•** to advance the cursor to the next position.
3. Repeat step 2 for the remaining characters: r,e,a,k,e,r, ,#,1.
4. Press **ENTER** to store the text.
5. If you have any problem, press **HELP** to view context sensitive help. Flash messages will sequentially appear for several seconds each. For the case of a text setting message, pressing **HELP** displays how to edit and store new values.

d) ACTIVATING THE RELAY

**RELAY SETTINGS:
Not Programmed**

When the relay is powered up, the Trouble LED will be on, the In Service LED off, and this message displayed, indicating the relay is in the "Not Programmed" state and is safeguarding (output relays blocked) against the installation of a relay whose settings have not been entered. This message remains until the relay is explicitly put in the "Programmed" state.

To change the RELAY SETTINGS: "Not Programmed" mode to "Programmed", proceed as follows:

1. Press the **MENU** key until the **SETTINGS** header flashes momentarily and the **SETTINGS PRODUCT SETUP** message appears on the display.
2. Press the MESSAGE **▶** key until the **PASSWORD SECURITY** message appears on the display.
3. Press the MESSAGE **▼** key until the **INSTALLATION** message appears on the display.
4. Press the MESSAGE **▶** key until the **RELAY SETTINGS: Not Programmed** message is displayed.

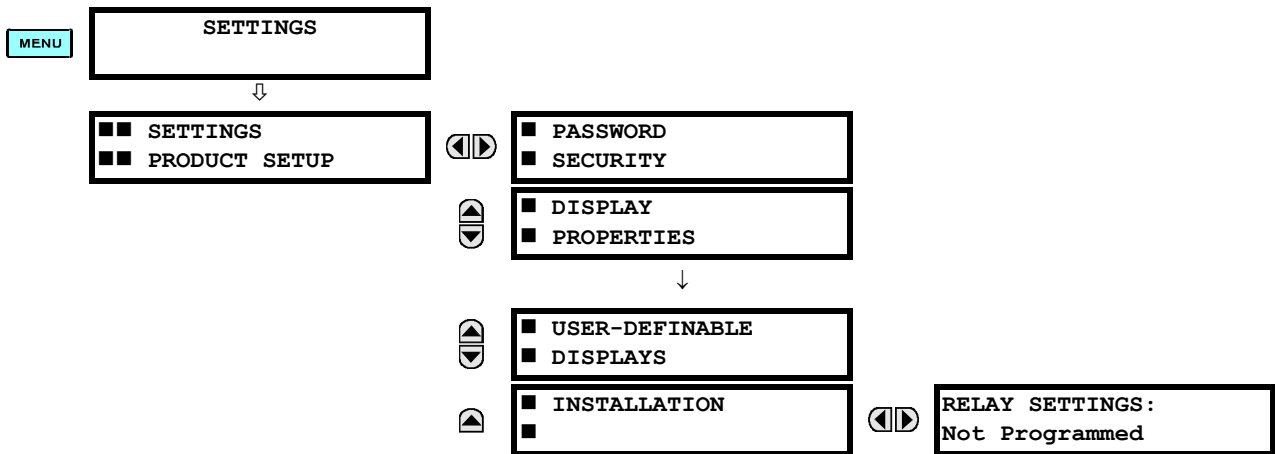

5. After the **RELAY SETTINGS: Not Programmed** message appears on the display, press the VALUE keys change the selection to "Programmed".
6. Press the **ENTER** key.

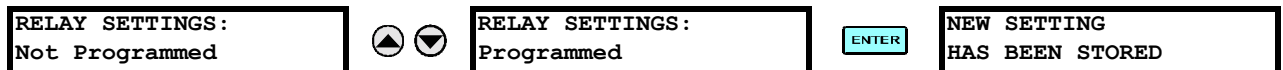

7. When the "NEW SETTING HAS BEEN STORED" message appears, the relay will be in "Programmed" state and the In Service LED will turn on.

e) ENTERING INITIAL PASSWORDS

To enter the initial Setting (or Command) Password, proceed as follows:

1. Press the **MENU** key until the **SETTINGS** header flashes momentarily and the **SETTINGS PRODUCT SETUP** message appears on the display.
2. Press the MESSAGE **▶** key until the **ACCESS LEVEL** message appears on the display.
3. Press the MESSAGE **▼** key until the **CHANGE SETTING (or COMMAND) PASSWORD** message appears on the display.

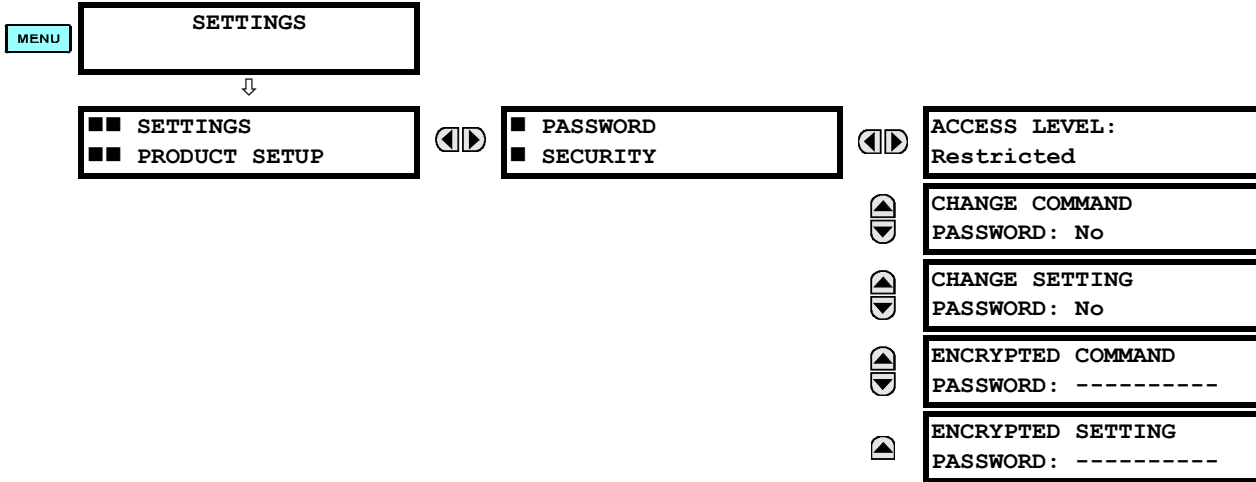

4. After the **CHANGE...PASSWORD** message appears on the display, press the VALUE **▲** key or the VALUE **▼** key to change the selection to "Yes".
5. Press the **ENTER** key and the display will prompt you to **ENTER NEW PASSWORD**.
6. Type in a numerical password (up to 10 characters) and press the **ENTER** key.
7. When the **VERIFY NEW PASSWORD** is displayed, re-type in the same password and press **ENTER**.

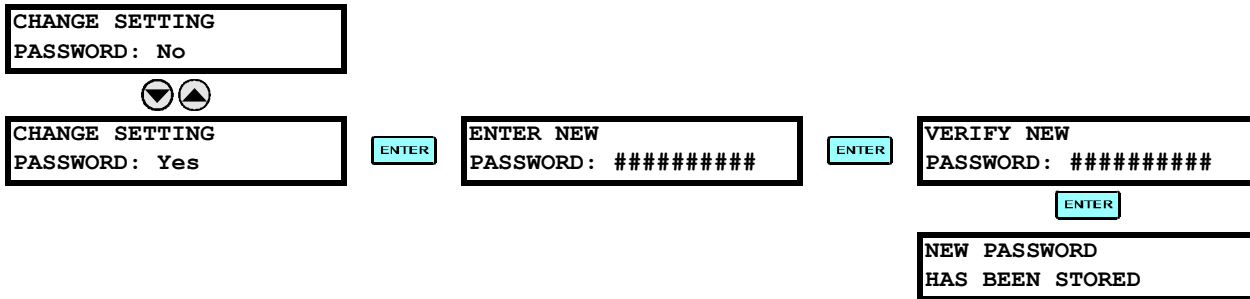























8. When the **NEW PASSWORD HAS BEEN STORED** message appears, your new Setting (or Command) Password will be active.

f) CHANGING EXISTING PASSWORDS

To change an existing password, follow the instructions in the previous section with the following exception. A message will prompt you to type in the existing password (for each security level) before a new password can be entered.

In the event that a password has been lost (forgotten), submit the corresponding Encrypted Password from the **PASSWORD SECURITY** menu to the Factory for decoding.

5.1.1 SETTINGS MAIN MENU

■■ SETTINGS ■■ PRODUCT SETUP		■ PASSWORD ■ SECURITY	See page 5-8.
		■ DISPLAY ■ PROPERTIES	See page 5-9.
		■ CLEAR RELAY ■ RECORDS	See page 5-11.
		■ COMMUNICATIONS ■	See page 5-12.
		■ MODBUS USER MAP ■	See page 5-21.
		■ REAL TIME ■ CLOCK	See page 5-21.
		■ FAULT REPORTS ■	See page 5-22.
		■ OSCILLOGRAPHY ■	See page 5-23.
		■ DATA LOGGER ■	See page 5-25.
		■ DEMAND ■	See page 5-26.
		■ USER-PROGRAMMABLE ■ LEDS	See page 5-27.
		■ USER-PROGRAMMABLE ■ SELF TESTS	See page 5-30.
		■ CONTROL ■ PUSHBUTTONS	See page 5-30.
		■ USER-PROGRAMMABLE ■ PUSHBUTTONS	See page 5-32.
		■ FLEX STATE ■ PARAMETERS	See page 5-33.
		■ USER-DEFINABLE ■ DISPLAYS	See page 5-34.
		■ DIRECT I/O ■	See page 5-36.
		■ INSTALLATION ■	See page 5-41.
		■ AC INPUTS ■	See page 5-42.
■■ SETTINGS ■■ SYSTEM SETUP		■ POWER SYSTEM ■	See page 5-43.
		■ SIGNAL SOURCES ■	See page 5-44.

▲	▲	■ FLEXCURVES ■	See page 5-46.
▲	▲	■ ■ SETTINGS ■ ■ FLEXLOGIC	
▼	◀▶	■ FLEXLOGIC ■ EQUATION EDITOR	See page 5-64.
▼	▲▼	■ FLEXLOGIC ■ TIMERS	See page 5-64.
▲	▲▼	■ FLEXELEMENTS ■	See page 5-65.
▲	▲	■ NON-VOLATILE ■ LATCHES	See page 5-69.
▲	▲	■ ■ SETTINGS ■ ■ GROUPED ELEMENTS	
▼	◀▶	■ SETTING GROUP 1 ■	See page 5-70.
▼	▲▼	■ SETTING GROUP 2 ■	
▲	▲▼	■ SETTING GROUP 3 ■	
▲	▲▼	■ SETTING GROUP 4 ■	
▲	▲▼	■ SETTING GROUP 5 ■	
▲	▲	■ SETTING GROUP 6 ■	
▲	▲	■ ■ SETTINGS ■ ■ CONTROL ELEMENTS	
▼	◀▶	■ SETTING GROUPS ■	See page 5-87.
▼	▲▼	■ SELECTOR SWITCH ■	See page 5-88.
▲	▲▼	■ UNDERFREQUENCY ■	See page 5-93.
▲	▲▼	■ AUTORECLOSE ■	See page 5-94.
▲	▲▼	■ DIGITAL ELEMENTS ■	See page 5-100.
▲	▲▼	■ DIGITAL COUNTERS ■	See page 5-103.
▲	▲▼	■ 8-BIT SWITCHES ■	See page 5-105.
▲	▲	■ MONITORING ■ ELEMENTS	See page 5-106.
▲	▲	■ ■ SETTINGS ■ ■ INPUTS/OUTPUTS	
▼	◀▶	■ CONTACT INPUTS ■	See page 5-109.
▼	▲▼	■ VIRTUAL INPUTS ■	See page 5-111.

	▲	■ CONTACT OUTPUTS	See page 5-112.
	▲▼	■ LATCHING OUTPUTS	See page 5-112.
	▲▼	■ VIRTUAL OUTPUTS	See page 5-114.
	▲▼	■ REMOTE DEVICES	See page 5-115.
	▲▼	■ REMOTE INPUTS	See page 5-116.
	▲▼	■ REMOTE OUTPUTS ■ DNA BIT PAIRS	See page 5-117.
	▲▼	■ REMOTE OUTPUTS ■ UserSt BIT PAIRS	See page 5-118.
	▲▼	■ RESETTING	See page 5-118.
	▲▼	■ DIRECT INPUTS	See page 5-118.
	▲	■ DIRECT OUTPUTS	See page 5-118.
▲			
■ ■ SETTINGS	▲▼	■ DCMA INPUTS	See page 5-122.
■ ■ TRANSDUCER I/O	▲▼	■ RTD INPUTS	See page 5-123.
▼	▲	■ DCMA OUTPUTS	See page 5-123.
▲			
■ ■ SETTINGS	▲▼	TEST MODE FUNCTION: Disabled	See page 5-127.
■ ■ TESTING	▲▼	TEST MODE INITIATE: On	See page 5-127.
	▲▼	■ FORCE CONTACT ■ INPUTS	See page 5-127.
	▲	■ FORCE CONTACT ■ OUTPUTS	See page 5-128.

5.1.2 INTRODUCTION TO ELEMENTS

In the design of UR relays, the term “element” is used to describe a feature that is based around a comparator. The comparator is provided with an input (or set of inputs) that is tested against a programmed setting (or group of settings) to determine if the input is within the defined range that will set the output to logic 1, also referred to as “setting the flag”. A single comparator may make multiple tests and provide multiple outputs; for example, the time overcurrent comparator sets a Pickup flag when the current input is above the setting and sets an Operate flag when the input current has been at a level above the pickup setting for the time specified by the time-current curve settings. All comparators, except the Digital Element which uses a logic state as the input, use analog parameter actual values as the input.

Elements are arranged into two classes, GROUPED and CONTROL. Each element classed as a GROUPED element is provided with six alternate sets of settings, in setting groups numbered 1 through 6. The performance of a GROUPED element is defined by the setting group that is active at a given time. The performance of a CONTROL element is independent of the selected active setting group.

The main characteristics of an element are shown on the element logic diagram. This includes the input(s), settings, fixed logic, and the output operands generated (abbreviations used on scheme logic diagrams are defined in Appendix F).

Some settings for current and voltage elements are specified in per-unit (pu) calculated quantities:

pu quantity = (actual quantity) / (base quantity)

- For current elements, the ‘base quantity’ is the nominal secondary or primary current of the CT. Where the current source is the sum of two CTs with different ratios, the ‘base quantity’ will be the common secondary or primary current to which the sum is scaled (i.e. normalized to the larger of the 2 rated CT inputs). For example, if CT1 = 300 / 5 A and CT2 = 100 / 5 A, then in order to sum these, CT2 is scaled to the CT1 ratio. In this case, the ‘base quantity’ will be 5 A secondary or 300 A primary.
- For voltage elements the ‘base quantity’ is the nominal primary voltage of the protected system which corresponds (based on VT ratio and connection) to secondary VT voltage applied to the relay. For example, on a system with a 13.8 kV nominal primary voltage and with 14400:120 V Delta-connected VTs, the secondary nominal voltage (1 pu) would be:

$$\frac{13800}{14400} \times 120 = 115 \text{ V} \quad (\text{EQ 5.1})$$

For Wye-connected VTs, the secondary nominal voltage (1 pu) would be:

$$\frac{13800}{14400} \times \frac{120}{\sqrt{3}} = 66.4 \text{ V} \quad (\text{EQ 5.2})$$

Many settings are common to most elements and are discussed below:

- FUNCTION setting:** This setting programs the element to be operational when selected as “Enabled”. The factory default is “Disabled”. Once programmed to “Enabled”, any element associated with the Function becomes active and all options become available.
- NAME setting:** This setting is used to uniquely identify the element.
- SOURCE setting:** This setting is used to select the parameter or set of parameters to be monitored.
- PICKUP setting:** For simple elements, this setting is used to program the level of the measured parameter above or below which the pickup state is established. In more complex elements, a set of settings may be provided to define the range of the measured parameters which will cause the element to pickup.
- PICKUP DELAY setting:** This setting sets a time-delay-on-pickup, or on-delay, for the duration between the Pickup and Operate output states.
- RESET DELAY setting:** This setting is used to set a time-delay-on-dropout, or off-delay, for the duration between the Operate output state and the return to logic 0 after the input transits outside the defined pickup range.
- BLOCK setting:** The default output operand state of all comparators is a logic 0 or “flag not set”. The comparator remains in this default state until a logic 1 is asserted at the RUN input, allowing the test to be performed. If the RUN input changes to logic 0 at any time, the comparator returns to the default state. The RUN input is used to supervise the comparator. The BLOCK input is used as one of the inputs to RUN control.

- **TARGET setting:** This setting is used to define the operation of an element target message. When set to Disabled, no target message or illumination of a faceplate LED indicator is issued upon operation of the element. When set to Self-Reset, the target message and LED indication follow the Operate state of the element, and self-resets once the operate element condition clears. When set to Latched, the target message and LED indication will remain visible after the element output returns to logic 0 - until a RESET command is received by the relay.
- **EVENTS setting:** This setting is used to control whether the Pickup, Dropout or Operate states are recorded by the event recorder. When set to Disabled, element pickup, dropout or operate are not recorded as events. When set to Enabled, events are created for:
 - (Element) PKP (pickup)
 - (Element) DPO (dropout)
 - (Element) OP (operate)

The DPO event is created when the measure and decide comparator output transits from the pickup state (logic 1) to the dropout state (logic 0). This could happen when the element is in the operate state if the reset delay time is not '0'.

5.1.3 INTRODUCTION TO AC SOURCES

a) BACKGROUND

The F35 may be used on systems with breaker-and-a-half or ring bus configurations. In these applications, each of the two three-phase sets of individual phase currents (one associated with each breaker) can be used as an input to a breaker failure element. The sum of both breaker phase currents and 3I₀ residual currents may be required for the circuit relaying and metering functions. For a three-winding transformer application, it may be required to calculate watts and vars for each of three windings, using voltage from different sets of VTs. These requirements can be satisfied with a single UR, equipped with sufficient CT and VT input channels, by selecting the parameter to measure. A mechanism is provided to specify the AC parameter (or group of parameters) used as the input to protection/control comparators and some metering elements.

Selection of the parameter(s) to measure is partially performed by the design of a measuring element or protection/control comparator by identifying the type of parameter (fundamental frequency phasor, harmonic phasor, symmetrical component, total waveform RMS magnitude, phase-phase or phase-ground voltage, etc.) to measure. The user completes the process by selecting the instrument transformer input channels to use and some of the parameters calculated from these channels. The input parameters available include the summation of currents from multiple input channels. For the summed currents of phase, 3I₀, and ground current, current from CTs with different ratios are adjusted to a single ratio before summation.

A mechanism called a "Source" configures the routing of CT and VT input channels to measurement sub-systems. Sources, in the context of UR series relays, refer to the logical grouping of current and voltage signals such that one source contains all the signals required to measure the load or fault in a particular power apparatus. A given source may contain all or some of the following signals: three-phase currents, single-phase ground current, three-phase voltages and an auxiliary voltage from a single VT for checking for synchronism.

To illustrate the concept of Sources, as applied to current inputs only, consider the breaker-and-a-half scheme below. In this application, the current flows as shown by the arrows. Some current flows through the upper bus bar to some other location or power equipment, and some current flows into transformer Winding 1. The current into Winding 1 is the phasor sum (or difference) of the currents in CT1 and CT2 (whether the sum or difference is used depends on the relative polarity of the CT connections). The same considerations apply to transformer Winding 2. The protection elements require access to the net current for transformer protection, but some elements may need access to the individual currents from CT1 and CT2.

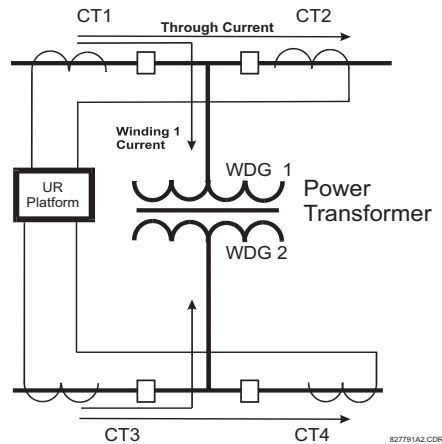

Figure 5–1: BREAKER-AND-A-HALF SCHEME

In conventional analog or electronic relays, the sum of the currents is obtained from an appropriate external connection of all CTs through which any portion of the current for the element being protected could flow. Auxiliary CTs are required to perform ratio matching if the ratios of the primary CTs to be summed are not identical. In the UR series of relays, provisions have been included for all the current signals to be brought to the UR device where grouping, ratio correction and summation are applied internally via configuration settings.

A major advantage of using internal summation is that the individual currents are available to the protection device; for example, as additional information to calculate a restraint current, or to allow the provision of additional protection features that operate on the individual currents such as breaker failure.

Given the flexibility of this approach, it becomes necessary to add configuration settings to the platform to allow the user to select which sets of CT inputs will be added to form the net current into the protected device.

The internal grouping of current and voltage signals forms an internal source. This source can be given a specific name through the settings, and becomes available to protection and metering elements in the UR platform. Individual names can be given to each source to help identify them more clearly for later use. For example, in the scheme shown in the above diagram, the configures one Source to be the sum of CT1 and CT2 and can name this Source as “Wdg 1 Current”.

Once the sources have been configured, the user has them available as selections for the choice of input signal for the protection elements and as metered quantities.

b) CT/VT MODULE CONFIGURATION

CT and VT input channels are contained in CT/VT modules. The type of input channel can be phase/neutral/other voltage, phase/ground current, or sensitive ground current. The CT/VT modules calculate total waveform RMS levels, fundamental frequency phasors, symmetrical components and harmonics for voltage or current, as allowed by the hardware in each channel. These modules may calculate other parameters as directed by the CPU module.

A CT/VT module contains up to eight input channels, numbered 1 through 8. The channel numbering corresponds to the module terminal numbering 1 through 8 and is arranged as follows: Channels 1, 2, 3 and 4 are always provided as a group, hereafter called a “bank,” and all four are either current or voltage, as are Channels 5, 6, 7 and 8. Channels 1, 2, 3 and 5, 6, 7 are arranged as phase A, B and C respectively. Channels 4 and 8 are either another current or voltage.

Banks are ordered sequentially from the block of lower-numbered channels to the block of higher-numbered channels, and from the CT/VT module with the lowest slot position letter to the module with the highest slot position letter, as follows:

INCREASING SLOT POSITION LETTER -->		
CT/VT MODULE 1	CT/VT MODULE 2	CT/VT MODULE 3
< bank 1 >	< bank 3 >	< bank 5 >
< bank 2 >	< bank 4 >	< bank 6 >

The UR platform allows for a maximum of three sets of three-phase voltages and six sets of three-phase currents. The result of these restrictions leads to the maximum number of CT/VT modules in a chassis to three. The maximum number of sources is six. A summary of CT/VT module configurations is shown below.

ITEM	MAXIMUM NUMBER
CT/VT Module	3
CT Bank (3 phase channels, 1 ground channel)	12
VT Bank (3 phase channels, 1 auxiliary channel)	6

c) CT/VT INPUT CHANNEL CONFIGURATION

Upon relay startup, configuration settings for every bank of current or voltage input channels in the relay are automatically generated from the order code. Within each bank, a channel identification label is automatically assigned to each bank of channels in a given product. The 'bank' naming convention is based on the physical location of the channels, required by the user to know how to connect the relay to external circuits. Bank identification consists of the letter designation of the slot in which the CT/VT module is mounted as the first character, followed by numbers indicating the channel, either 1 or 5.

For three-phase channel sets, the number of the lowest numbered channel identifies the set. For example, F1 represents the three-phase channel set of F1/F2/F3, where F is the slot letter and 1 is the first channel of the set of three channels.

Upon startup, the CPU configures the settings required to characterize the current and voltage inputs, and will display them in the appropriate section in the sequence of the banks (as described above) as follows for a maximum configuration: F1, F5, M1, M5, U1, and U5.

The above section explains how the input channels are identified and configured to the specific application instrument transformers and the connections of these transformers. The specific parameters to be used by each measuring element and comparator, and some actual values are controlled by selecting a specific source. The source is a group of current and voltage input channels selected by the user to facilitate this selection. With this mechanism, a user does not have to make multiple selections of voltage and current for those elements that need both parameters, such as a distance element or a watt calculation. It also gathers associated parameters for display purposes.

The basic idea of arranging a source is to select a point on the power system where information is of interest. An application example of the grouping of parameters in a Source is a transformer winding, on which a three phase voltage is measured, and the sum of the currents from CTs on each of two breakers is required to measure the winding current flow.

5.2.1 PASSWORD SECURITY

PATH: SETTINGS ⇨ PRODUCT SETUP ⇨ PASSWORD SECURITY

<ul style="list-style-type: none"> ■ PASSWORD ■ SECURITY 	◀▶	ACCESS LEVEL: Restricted	Range: Restricted, Command, Setting, Factory Service (for factory use only)
MESSAGE	▲▼	CHANGE COMMAND PASSWORD: No	Range: No, Yes
MESSAGE	▲▼	CHANGE SETTING PASSWORD: No	Range: No, Yes
MESSAGE	▲▼	ENCRYPTED COMMAND PASSWORD: -----	Range: 0 to 9999999999 Note: ----- indicates no password
MESSAGE	▲	ENCRYPTED SETTING PASSWORD: -----	Range: 0 to 9999999999 Note: ----- indicates no password

Two levels of password security are provided: **Command** and **Setting**. Operations under password supervision are:

- **COMMAND:** changing the state of virtual inputs, clearing the event records, clearing the oscillography records, changing the date and time, clearing energy records, clearing the data logger, user-programmable pushbuttons
- **SETTING:** changing any setting, test mode operation

The Command and Setting passwords are defaulted to "Null" when the relay is shipped from the factory. When a password is set to "Null", the password security feature is disabled.

Programming a password code is required to enable each access level. A password consists of 1 to 10 numerical characters. When a **CHANGE ... PASSWORD** setting is set to "Yes", the following message sequence is invoked:

1. ENTER NEW PASSWORD: _____
2. VERIFY NEW PASSWORD: _____
3. NEW PASSWORD HAS BEEN STORED

To gain write access to a "Restricted" setting, set **ACCESS LEVEL** to "Setting" and then change the setting, or attempt to change the setting and follow the prompt to enter the programmed password. If the password is correctly entered, access will be allowed. If no keys are pressed for longer than 30 minutes or control power is cycled, accessibility will automatically revert to the "Restricted" level.

If an entered password is lost (or forgotten), consult the factory with the corresponding **ENCRYPTED PASSWORD**.

The F35 provides a means to raise an alarm upon failed password entry. Should password verification fail while accessing a password-protected level of the relay (either settings or commands), the UNAUTHORIZED ACCESS FlexLogic™ operand is asserted. The operand can be programmed to raise an alarm via contact outputs or communications. This feature can be used to protect against both unauthorized and accidental access attempts.

The UNAUTHORIZED ACCESS operand is reset with the **COMMANDS ⇨ CLEAR RECORDS ⇨ RESET UNAUTHORIZED ALARMS** command. Therefore, to apply this feature with security, the command level should be password-protected.

The operand does not generate events or targets. If these are required, the operand can be assigned to a digital element programmed with event logs and/or targets enabled.



If the SETTING and COMMAND passwords are identical, this one password allows access to both commands and settings.

NOTE



NOTE

When enerVista UR Setup is used to access a particular level, the user will continue to have access to that level as long as there are open windows in the enerVista UR Setup software. To re-establish the Password Security feature, all windows must be closed for at least 30 minutes.

5.2.2 DISPLAY PROPERTIES

PATH: SETTINGS ⇒ PRODUCT SETUP ⇒ DISPLAY PROPERTIES

■ DISPLAY		FLASH MESSAGE	Range: 0.5 to 10.0 s in steps of 0.1
■ PROPERTIES	◀▶	TIME: 1.0 s	
MESSAGE	▲▼	DEFAULT MESSAGE	Range: 10 to 900 s in steps of 1
		TIMEOUT: 300 s	
MESSAGE	▲▼	DEFAULT MESSAGE	Range: 25%, 50%, 75%, 100%
		INTENSITY: 25 %	Visible only if a VFD is installed
MESSAGE	▲▼	SCREEN SAVER	Range: Disabled, Enabled
		FEATURE: Disabled	Visible only if an LCD is installed
MESSAGE	▲▼	SCREEN SAVER	Range: 1 to 65535 min. in steps of 1
		WAIT TIME: 30 min	Visible only if an LCD is installed
MESSAGE	▲▼	CURRENT CUT-OFF	Range: 0.002 to 0.020 pu in steps of 0.001
		LEVEL: 0.020 pu	
MESSAGE	▲	VOLTAGE CUT-OFF	Range: 0.1 to 1.0 V secondary in steps of 0.1
		LEVEL: 1.0 V	

Some relay messaging characteristics can be modified to suit different situations using the display properties settings.

- **FLASH MESSAGE TIME:** Flash messages are status, warning, error, or information messages displayed for several seconds in response to certain key presses during setting programming. These messages override any normal messages. The duration of a flash message on the display can be changed to accommodate different reading rates.
- **DEFAULT MESSAGE TIMEOUT:** If the keypad is inactive for a period of time, the relay automatically reverts to a default message. The inactivity time is modified via this setting to ensure messages remain on the screen long enough during programming or reading of actual values.
- **DEFAULT MESSAGE INTENSITY:** To extend phosphor life in the vacuum fluorescent display, the brightness can be attenuated during default message display. During keypad interrogation, the display always operates at full brightness.
- **SCREEN SAVER FEATURE and SCREEN SAVER WAIT TIME:** These settings are only visible if the F35 has a liquid crystal display (LCD) and control its backlighting. When the **SCREEN SAVER FEATURE** is “Enabled”, the LCD backlighting is turned off after the **DEFAULT MESSAGE TIMEOUT** followed by the **SCREEN SAVER WAIT TIME**, providing that no keys have been pressed and no target messages are active. When a keypress occurs or a target becomes active, the LCD backlighting is turned on.
- **CURRENT CUT-OFF LEVEL:** This setting modifies the current cut-off threshold. Very low currents (1 to 2% of the rated value) are very susceptible to noise. Some customers prefer very low currents to display as zero, while others prefer the current be displayed even when the value reflects noise rather than the actual signal. The F35 applies a cut-off value to the magnitudes and angles of the measured currents. If the magnitude is below the cut-off level, it is substituted with zero. This applies to phase and ground current phasors as well as true RMS values and symmetrical components. The cut-off operation applies to quantities used for metering, protection, and control, as well as those used by communications protocols. Note that the cut-off level for the sensitive ground input is 10 times lower than the **CURRENT CUT-OFF LEVEL** setting value. Raw current samples available via oscillography are not subject to cut-off.
- **VOLTAGE CUT-OFF LEVEL:** This setting modifies the voltage cut-off threshold. Very low secondary voltage measurements (at the fractional volt level) can be affected by noise. Some customers prefer these low voltages to be displayed as zero, while others prefer the voltage to be displayed even when the value reflects noise rather than the actual signal. The F35 applies a cut-off value to the magnitudes and angles of the measured voltages. If the magnitude is below the cut-off level, it is substituted with zero. This operation applies to phase and auxiliary voltages, and symmetrical components. The cut-off operation applies to quantities used for metering, protection, and control, as well as those used by communications protocols. Raw samples of the voltages available via oscillography are not subject cut-off. This setting relates to the actual measured voltage at the VT secondary inputs. It can be converted to per-unit values (pu) by dividing by the **PHASE VT SECONDARY** setting value. For example, a **PHASE VT SECONDARY** setting of “66.4 V” and a **VOLTAGE CUT-OFF LEVEL** setting of “1.0 V” gives a cut-off value of $1.0 \text{ V} / 66.4 \text{ V} = 0.015 \text{ pu}$.

The **CURRENT CUT-OFF LEVEL** and the **VOLTAGE CUT-OFF LEVEL** are used to determine the metered power cut-off levels. The power cut-off level is calculated as follows:

$$\text{power cut-off level} = \text{CURRENT CUT-OFF LEVEL} \times \text{VOLTAGE CUT-OFF LEVEL} \times 1.0 \text{ pu current} \times 1.0 \text{ pu voltage} \quad (\text{EQ 5.3})$$

For example, given the following settings:

CURRENT CUT-OFF LEVEL: "0.02 pu"

VOLTAGE CUT-OFF LEVEL: "1.0 V"

PHASE CT PRIMARY: "100 A"

PHASE VT SECONDARY: "66.4 V"

PHASE VT RATIO: "208.00 : 1".

We have:

1.0 pu current = CT primary = "100 A", and

1.0 pu voltage = PHASE VT SECONDARY x PHASE VT RATIO = 66.4 V x 208 = 13811.2 V

The power cut-off is therefore:

$$\begin{aligned} \text{power cut-off} &= \text{CURRENT CUT-OFF LEVEL} \times \text{VOLTAGE CUT-OFF LEVEL} \times 1.0 \text{ pu current} \times 1.0 \text{ pu voltage} \\ &= 0.02 \text{ pu} \times 0.015 \text{ pu} \times 100 \text{ A} \times 13811.2 \text{ V} \\ &= 416 \text{ watts} \end{aligned}$$

Any calculated power value below this cut-off will not be displayed. As well, the three-phase energy data will not accumulate if the total power from all three phases does not exceed the power cut-off.



Lower the VOLTAGE CUT-OFF LEVEL and CURRENT CUT-OFF LEVEL with care as the relay accepts lower signals as valid measurements. Unless dictated otherwise by a specific application, the default settings of "0.02 pu" for CURRENT CUT-OFF LEVEL and "1.0 V" for VOLTAGE CUT-OFF LEVEL are recommended.

5.2.3 CLEAR RELAY RECORDS

PATH: SETTINGS ⇒ PRODUCT SETUP ⇒ CLEAR RELAY RECORDS

■ CLEAR RELAY		◀▶	CLEAR FAULT REPORTS: Off	Range: FlexLogic™ operand
■ RECORDS	MESSAGE	▲▼	CLEAR EVENT RECORDS: Off	Range: FlexLogic™ operand
	MESSAGE	▲▼	CLEAR OSCILLOGRAPHY? No	Range: FlexLogic™ operand
	MESSAGE	▲▼	CLEAR DATA LOGGER: Off	Range: FlexLogic™ operand
	MESSAGE	▲▼	CLEAR ARC AMPS 1: Off	Range: FlexLogic™ operand
	MESSAGE	▲▼	CLEAR ARC AMPS 2: Off	Range: FlexLogic™ operand
	MESSAGE	▲▼	CLEAR DEMAND: Off	Range: FlexLogic™ operand
	MESSAGE	▲▼	CLEAR ENERGY: Off	Range: FlexLogic™ operand
	MESSAGE	▲▼	RESET UNAUTH ACCESS: Off	Range: FlexLogic™ operand
	MESSAGE	▲	CLEAR DIR I/O STATS: Off	Range: FlexLogic™ operand. Valid only for units with Direct I/O module.

Selected records can be cleared from user-programmable conditions with FlexLogic™ operands. Assigning user-programmable pushbuttons to clear specific records are typical applications for these commands. Since the F35 responds to rising edges of the configured FlexLogic™ operands, they must be asserted for at least 50 ms to take effect.

Clearing records with user-programmable operands is not protected by the command password. However, user-programmable pushbuttons are protected by the command password. Thus, if they are used to clear records, the user-programmable pushbuttons can provide extra security if required.

For example, to assign User-Programmable Pushbutton 1 to clear demand records, the following settings should be applied.

- Assign the clear demand function to Pushbutton 1 by making the following change in the **SETTINGS ⇒ PRODUCT SETUP ⇒ CLEAR RELAY RECORDS** menu:
CLEAR DEMAND: "PUSHBUTTON 1 ON"
- Set the properties for User-Programmable Pushbutton 1 by making the following changes in the **SETTINGS ⇒ PRODUCT SETUP ⇒ USER-PROGRAMMABLE PUSHBUTTONS ⇒ USER PUSHBUTTON 1** menu:
PUSHBUTTON 1 FUNCTION: "Self-reset"
PUSHBTN 1 DROP-OUT TIME: "0.20 s"

5.2.4 COMMUNICATIONS

a) MAIN MENU

PATH: SETTINGS ⇒ PRODUCT SETUP ⇨ COMMUNICATIONS

<div style="border: 1px solid black; padding: 2px;"> ■ COMMUNICATIONS ■ </div>	◀▶	<div style="border: 1px solid black; padding: 2px;"> ■ SERIAL PORTS ■ </div>	See below.
MESSAGE	▲▼	<div style="border: 1px solid black; padding: 2px;"> ■ NETWORK ■ </div>	See page 5-13.
MESSAGE	▲▼	<div style="border: 1px solid black; padding: 2px;"> ■ MODBUS PROTOCOL ■ </div>	See page 5-13.
MESSAGE	▲▼	<div style="border: 1px solid black; padding: 2px;"> ■ DNP PROTOCOL ■ </div>	See page 5-14.
MESSAGE	▲▼	<div style="border: 1px solid black; padding: 2px;"> ■ IEC 61850 PROTOCOL ■ </div>	See page 5-16.
MESSAGE	▲▼	<div style="border: 1px solid black; padding: 2px;"> ■ WEB SERVER ■ HTTP PROTOCOL </div>	See page 5-17.
MESSAGE	▲▼	<div style="border: 1px solid black; padding: 2px;"> ■ TFTP PROTOCOL ■ </div>	See page 5-17.
MESSAGE	▲▼	<div style="border: 1px solid black; padding: 2px;"> ■ IEC 60870-5-104 ■ PROTOCOL </div>	See page 5-18.
MESSAGE	▲▼	<div style="border: 1px solid black; padding: 2px;"> ■ Sntp PROTOCOL ■ </div>	See page 5-19.
MESSAGE	▲	<div style="border: 1px solid black; padding: 2px;"> ■ EGD PROTOCOL ■ </div>	See page 5-19.

b) SERIAL PORTS

PATH: SETTINGS ⇒ PRODUCT SETUP ⇨ COMMUNICATIONS ⇨ SERIAL PORTS

<div style="border: 1px solid black; padding: 2px;"> ■ SERIAL PORTS ■ </div>	◀▶	<div style="border: 1px solid black; padding: 2px;"> RS485 COM1 BAUD RATE: 19200 </div>	Range: 300, 1200, 2400, 4800, 9600, 14400, 19200, 28800, 33600, 38400, 57600, 115200. Only active if CPU 9E is ordered.
MESSAGE	▲▼	<div style="border: 1px solid black; padding: 2px;"> RS485 COM1 PARITY: None </div>	Range: None, Odd, Even Only active if CPU Type 9E is ordered
MESSAGE	▲▼	<div style="border: 1px solid black; padding: 2px;"> RS485 COM1 RESPONSE MIN TIME: 0 ms </div>	Range: 0 to 1000 ms in steps of 10 Only active if CPU Type 9E is ordered
MESSAGE	▲▼	<div style="border: 1px solid black; padding: 2px;"> RS485 COM2 BAUD RATE: 19200 </div>	Range: 300, 1200, 2400, 4800, 9600, 14400, 19200, 28800, 33600, 38400, 57600, 115200
MESSAGE	▲▼	<div style="border: 1px solid black; padding: 2px;"> RS485 COM2 PARITY: None </div>	Range: None, Odd, Even
MESSAGE	▲	<div style="border: 1px solid black; padding: 2px;"> RS485 COM2 RESPONSE MIN TIME: 0 ms </div>	Range: 0 to 1000 ms in steps of 10

The F35 is equipped with up to 3 independent serial communication ports. The faceplate RS232 port is intended for local use and is fixed at 19200 baud and no parity. The rear COM1 port type is selected when ordering: either an Ethernet or RS485 port. The rear COM2 port is RS485. The RS485 ports have settings for baud rate and parity. It is important that these parameters agree with the settings used on the computer or other equipment that is connected to these ports. Any of these ports may be connected to a computer running enerVista UR Setup. This software can download and upload setting files, view measured parameters, and upgrade the relay firmware. A maximum of 32 relays can be daisy-chained and connected to a DCS, PLC or PC using the RS485 ports.



For each RS485 port, the minimum time before the port will transmit after receiving data from a host can be set. This feature allows operation with hosts which hold the RS485 transmitter active for some time after each transmission.

c) NETWORK

PATH: SETTINGS ⇒ PRODUCT SETUP ⇒ COMMUNICATIONS ⇒ NETWORK

<input checked="" type="checkbox"/> NETWORK <input type="checkbox"/>		IP ADDRESS: 0.0.0.0	<i>Range: Standard IP address format Only active if CPU Type 9G or 9H is ordered.</i>
MESSAGE		SUBNET IP MASK: 0.0.0.0	<i>Range: Standard IP address format Only active if CPU Type 9G or 9H is ordered.</i>
MESSAGE		GATEWAY IP ADDRESS: 0.0.0.0	<i>Range: Standard IP address format Only active if CPU Type 9G or 9H is ordered.</i>
MESSAGE		<input checked="" type="checkbox"/> OSI NETWORK <input checked="" type="checkbox"/> ADDRESS (NSAP)	<i>Range: Press the MESSAGE ⇌ key to enter the OSI NETWORK ADDRESS. Only active if CPU Type 9G or 9H is ordered.</i>
MESSAGE		ETHERNET OPERATION MODE: Full-Duplex	<i>Range: Half-Duplex, Full-Duplex Only active if CPU Type 9G or 9H is ordered.</i>

These messages appear only if the F35 is ordered with an Ethernet card.

The IP addresses are used with the DNP, Modbus/TCP, IEC 61580, IEC 60870-5-104, TFTP, and HTTP protocols. The NSAP address is used with the IEC 61850 protocol over the OSI (CLNP/TP4) stack only. Each network protocol has a setting for the **TCP/UDP PORT NUMBER**. These settings are used only in advanced network configurations and should normally be left at their default values, but may be changed if required (for example, to allow access to multiple UR-series relays behind a router). By setting a different **TCP/UDP PORT NUMBER** for a given protocol on each UR-series relay, the router can map the relays to the same external IP address. The client software (enerVista UR Setup, for example) must be configured to use the correct port number if these settings are used.



When the NSAP address, any TCP/UDP Port Number, or any User Map setting (when used with DNP) is changed, it will not become active until power to the relay has been cycled (OFF/ON).



Do not set more than one protocol to use the same TCP/UDP PORT NUMBER, as this will result in unreliable operation of those protocols.

d) MODBUS PROTOCOL









































PATH: SETTINGS ⇒ PRODUCT SETUP ⇒ COMMUNICATIONS ⇒ MODBUS PROTOCOL

<input checked="" type="checkbox"/> MODBUS PROTOCOL <input type="checkbox"/>		MODBUS SLAVE ADDRESS: 254	<i>Range: 1 to 254 in steps of 1</i>
MESSAGE		MODBUS TCP PORT NUMBER: 502	<i>Range: 1 to 65535 in steps of 1</i>

The serial communication ports utilize the Modbus protocol, unless configured for DNP operation (see the DNP Protocol description below). This allows the enerVista UR Setup software to be used. The UR operates as a Modbus slave device only. When using Modbus protocol on the RS232 port, the F35 will respond regardless of the **MODBUS SLAVE ADDRESS** programmed. For the RS485 ports each F35 must have a unique address from 1 to 254. Address 0 is the broadcast address which all Modbus slave devices listen to. Addresses do not have to be sequential, but no two devices can have the same address or conflicts resulting in errors will occur. Generally, each device added to the link should use the next higher address starting at 1. Refer to Appendix B for more information on the Modbus protocol.

e) DNP PROTOCOL

PATH: SETTINGS ⇒ PRODUCT SETUP ⇨ COMMUNICATIONS ⇨ DNP PROTOCOL

<input checked="" type="checkbox"/> DNP PROTOCOL <input type="checkbox"/>		DNP PORT: NONE	Range: NONE, COM1 - RS485, COM2 - RS485, FRONT PANEL - RS232, NETWORK
MESSAGE	 	DNP ADDRESS: 255	Range: 0 to 65519 in steps of 1
MESSAGE	 	<input checked="" type="checkbox"/> DNP NETWORK <input checked="" type="checkbox"/> CLIENT ADDRESSES	Range: Press the MESSAGE ⇨ key to enter the DNP NETWORK CLIENT ADDRESSES
MESSAGE	 	DNP TCP/UDP PORT NUMBER: 20000	Range: 1 to 65535 in steps of 1
MESSAGE	 	DNP UNSOL RESPONSE FUNCTION: Disabled	Range: Enabled, Disabled
MESSAGE	 	DNP UNSOL RESPONSE TIMEOUT: 5 s	Range: 0 to 60 s in steps of 1
MESSAGE	 	DNP UNSOL RESPONSE MAX RETRIES: 10	Range: 1 to 255 in steps of 1
MESSAGE	 	DNP UNSOL RESPONSE DEST ADDRESS: 1	Range: 0 to 65519 in steps of 1
MESSAGE	 	USER MAP FOR DNP ANALOGS: Disabled	Range: Enabled, Disabled
MESSAGE	 	NUMBER OF SOURCES IN ANALOG LIST: 1	Range: 1 to 6 in steps of 1
MESSAGE	 	DNP CURRENT SCALE FACTOR: 1	Range: 0.001, 0.01, 0.1, 1, 10, 100, 1000, 10000, 100000
MESSAGE	 	DNP VOLTAGE SCALE FACTOR: 1	Range: 0.001, 0.01, 0.1, 1, 10, 100, 1000, 10000, 100000
MESSAGE	 	DNP POWER SCALE FACTOR: 1	Range: 0.001, 0.01, 0.1, 1, 10, 100, 1000, 10000, 100000
MESSAGE	 	DNP ENERGY SCALE FACTOR: 1	Range: 0.001, 0.01, 0.1, 1, 10, 100, 1000, 10000, 100000
MESSAGE	 	DNP OTHER SCALE FACTOR: 1	Range: 0.001, 0.01, 0.1, 1, 10, 100, 1000, 10000, 100000
MESSAGE	 	DNP CURRENT DEFAULT DEADBAND: 30000	Range: 0 to 65535 in steps of 1
MESSAGE	 	DNP VOLTAGE DEFAULT DEADBAND: 30000	Range: 0 to 65535 in steps of 1
MESSAGE	 	DNP POWER DEFAULT DEADBAND: 30000	Range: 0 to 65535 in steps of 1
MESSAGE	 	DNP ENERGY DEFAULT DEADBAND: 30000	Range: 0 to 65535 in steps of 1
MESSAGE	 	DNP OTHER DEFAULT DEADBAND: 30000	Range: 0 to 65535 in steps of 1
MESSAGE	 	DNP TIME SYNC IIN PERIOD: 1440 min	Range: 1 to 10080 min. in steps of 1

MESSAGE		DNP MESSAGE FRAGMENT SIZE: 240	Range: 30 to 2048 in steps of 1
MESSAGE		<input type="checkbox"/> DNP BINARY INPUTS <input type="checkbox"/> USER MAP	
MESSAGE		DNP OBJECT 1 DEFAULT VARIATION: 2	Range: 1, 2
MESSAGE		DNP OBJECT 2 DEFAULT VARIATION: 2	Range: 1, 2
MESSAGE		DNP OBJECT 20 DEFAULT VARIATION: 1	Range: 1, 2, 5, 6
MESSAGE		DNP OBJECT 21 DEFAULT VARIATION: 1	Range: 1, 2, 9, 10
MESSAGE		DNP OBJECT 22 DEFAULT VARIATION: 1	Range: 1, 2, 5, 6
MESSAGE		DNP OBJECT 23 DEFAULT VARIATION: 2	Range: 1, 2, 5, 6
MESSAGE		DNP OBJECT 30 DEFAULT VARIATION: 1	Range: 1, 2, 3, 4, 5
MESSAGE		DNP OBJECT 32 DEFAULT VARIATION: 1	Range: 1, 2, 3, 4, 5, 7

The F35 supports the Distributed Network Protocol (DNP) version 3.0. The F35 can be used as a DNP slave device connected to a single DNP master (usually an RTU or a SCADA master station). Since the F35 maintains one set of DNP data change buffers and connection information, only one DNP master should actively communicate with the F35 at one time. The **DNP PORT** setting selects the communications port assigned to the DNP protocol; only a single port can be assigned. Once DNP is assigned to a serial port, the Modbus protocol is disabled on that port. Note that COM1 can be used only in non-ethernet UR relays. When this setting is set to “Network”, the DNP protocol can be used over either TCP/IP or UDP/IP. Refer to Appendix E for more information on the DNP protocol. The **DNP ADDRESS** setting is the DNP slave address. This number identifies the F35 on a DNP communications link. Each DNP slave should be assigned a unique address. The **DNP NETWORK CLIENT ADDRESS** setting can force the F35 to respond to a maximum of five specific DNP masters.

The **DNP UNSOL RESPONSE FUNCTION** should be “Disabled” for RS485 applications since there is no collision avoidance mechanism. The **DNP UNSOL RESPONSE TIMEOUT** sets the time the F35 waits for a DNP master to confirm an unsolicited response. The **DNP UNSOL RESPONSE MAX RETRIES** setting determines the number of times the F35 retransmits an unsolicited response without receiving confirmation from the master; a value of “255” allows infinite re-tries. The **DNP UNSOL RESPONSE DEST ADDRESS** is the DNP address to which all unsolicited responses are sent. The IP address to which unsolicited responses are sent is determined by the F35 from the current TCP connection or the most recent UDP message.

The **USER MAP FOR DNP ANALOGS** setting allows the large pre-defined Analog Inputs points list to be replaced by the much smaller Modbus User Map. This can be useful for users wishing to read only selected Analog Input points from the F35. See Appendix E for more information.

The **NUMBER OF SOURCES IN ANALOG LIST** setting allows the selection of the number of current/voltage source values that are included in the Analog Inputs points list. This allows the list to be customized to contain data for only the sources that are configured. This setting is relevant only when the User Map is not used.

The **DNP SCALE FACTOR** settings are numbers used to scale Analog Input point values. These settings group the F35 Analog Input data into types: current, voltage, power, energy, and other. Each setting represents the scale factor for all Analog Input points of that type. For example, if the **DNP VOLTAGE SCALE FACTOR** setting is set to a value of 1000, all DNP Analog Input points that are voltages will be returned with values 1000 times smaller (e.g. a value of 72000 V on the F35 will be returned as 72). These settings are useful when analog input values must be adjusted to fit within certain ranges in DNP masters. Note that a scale factor of 0.1 is equivalent to a multiplier of 10 (i.e. the value will be 10 times larger).

The **DNP DEFAULT DEADBAND** settings determine when to trigger unsolicited responses containing Analog Input data. These settings group the F35 Analog Input data into types: current, voltage, power, energy, and other. Each setting represents the default deadband value for all Analog Input points of that type. For example, to trigger unsolicited responses from the F35

when any current values change by 15 A, the **DNP CURRENT DEFAULT DEADBAND** setting should be set to “15”. Note that these settings are the deadband default values. DNP Object 34 points can be used to change deadband values, from the default, for each individual DNP Analog Input point. Whenever power is removed and re-applied to the F35, the default deadbands will be in effect.

The **DNP TIME SYNC IIN PERIOD** setting determines how often the Need Time Internal Indication (IIN) bit is set by the F35. Changing this time allows the DNP master to send time synchronization commands more or less often, as required.

The **DNP MESSAGE FRAGMENT SIZE** setting determines the size, in bytes, at which message fragmentation occurs. Large fragment sizes allow for more efficient throughput; smaller fragment sizes cause more application layer confirmations to be necessary which can provide for more robust data transfer over noisy communication channels.

The **DNP BINARY INPUTS USER MAP** setting allows for the creation of a custom DNP Binary Inputs points list. The default DNP Binary Inputs list contains 928 points representing various binary states (contact inputs and outputs, virtual inputs and outputs, protection element states, etc.). If not all of these points are required in the DNP master, a custom Binary Inputs points list can be created by selecting up to 58 blocks of 16 points. Each block represents 16 binary input points. Block 1 represents binary input points 0 to 15, block 2 represents binary input points 16 to 31, block 3 represents binary input points 32 to 47, etc. The minimum number of binary input points that can be selected is 16 (1 block). If all of the **BIN INPUT BLOCK X** settings are set to “Not Used”, the standard list of 928 points will be in effect. The F35 will form the binary inputs points list from the **BIN INPUT BLOCK X** settings up to the first occurrence of a setting value of “Not Used”.



When using the User Maps for DNP data points (analog inputs and/or binary inputs) for relays with ethernet installed, check the “DNP Points Lists” F35 web page to ensure the desired points lists are created. This web page can be viewed using a web browser by entering the F35 IP address to access the F35 “Main Menu”, then by selecting the “Device Information Menu” > “DNP Points Lists” menu item.

The **DNP OBJECT N DEFAULT VARIATION** settings allow the user to select the DNP default variation number for object types 1, 2, 20, 21, 22, 23, 30, and 32. The default variation refers to the variation response when variation 0 is requested and/or in class 0, 1, 2, or 3 scans. Refer to the *DNP Implementation* section in Appendix E for additional details.

5

f) IEC 61850 PROTOCOL

PATH: SETTINGS ⇒ PRODUCT SETUP ⇄ COMMUNICATIONS ⇄ IEC 61850 PROTOCOL

<input checked="" type="checkbox"/> IEC 61850 PROTOCOL		DEFAULT GSSE UPDATE TIME: 60 s	Range: 1 to 60 s in steps of 1. See <i>UserSt Bit Pairs</i> in the <i>Remote Outputs</i> section of this Chapter.
MESSAGE		LOGICAL DEVICE NAME: IECDevice	Range: Up to 16 alphanumeric characters representing the name of the IEC 61850 logical device.
MESSAGE		IEC/MMS TCP PORT NUMBER: 102	Range: 1 to 65535 in steps of 1
MESSAGE		GSSE FUNCTION: Enabled	Range: Disabled, Enabled

The F35 supports the Manufacturing Message Specification (MMS) protocol as specified by IEC 61850. MMS is supported over two protocol stacks: TCP/IP over ethernet and TP4/CLNP (OSI) over ethernet. The F35 operates as an IEC 61850 server. The *Remote Inputs/Outputs* section in this chapter describe the peer-to-peer GSSE message scheme.

The **LOGICAL DEVICE NAME** setting represents the MMS domain name (IEC 61850 logical device) where all IEC/MMS objects are located. The **GSSE FUNCTION** setting allows for the blocking of GSSE messages from the F35. This can be used during testing or to prevent the relay from sending GSSE messages during normal operation.



Since GSSE messages are multicast ethernet by specification, router networks must not be used for IEC/MMS.

g) WEB SERVER HTTP PROTOCOL



PATH: SETTINGS ⇒ PRODUCT SETUP ⇒ COMMUNICATIONS ⇒ WEB SERVER HTTP PROTOCOL

<input checked="" type="checkbox"/> WEB SERVER <input checked="" type="checkbox"/> HTTP PROTOCOL		HTTP TCP PORT NUMBER: 80	<i>Range: 1 to 65535 in steps of 1</i>
---	---	-----------------------------	--

The F35 contains an embedded web server and is capable of transferring web pages to a web browser such as Microsoft Internet Explorer or Netscape Navigator. This feature is available only if the F35 has the ethernet option installed. The web pages are organized as a series of menus that can be accessed starting at the F35 “Main Menu”. Web pages are available showing DNP and IEC 60870-5-104 points lists, Modbus registers, Event Records, Fault Reports, etc. The web pages can be accessed by connecting the UR and a computer to an ethernet network. The Main Menu will be displayed in the web browser on the computer simply by entering the IP address of the F35 into the “Address” box on the web browser.

h) TFTP PROTOCOL

PATH: SETTINGS ⇒ PRODUCT SETUP ⇒ COMMUNICATIONS ⇒ TFTP PROTOCOL

<input checked="" type="checkbox"/> TFTP PROTOCOL		TFTP MAIN UDP PORT NUMBER: 69	<i>Range: 1 to 65535 in steps of 1</i>
MESSAGE 		TFTP DATA UDP PORT 1 NUMBER: 0	<i>Range: 0 to 65535 in steps of 1</i>
MESSAGE 		TFTP DATA UDP PORT 2 NUMBER: 0	<i>Range: 0 to 65535 in steps of 1</i>

The Trivial File Transfer Protocol (TFTP) can be used to transfer files from the UR over a network. The F35 operates as a TFTP server. TFTP client software is available from various sources, including Microsoft Windows NT. The `dir.txt` file obtained from the F35 contains a list and description of all available files (event records, oscillography, etc.).

i) IEC 60870-5-104 PROTOCOL

PATH: SETTINGS ⇒ PRODUCT SETUP ⇒ COMMUNICATIONS ⇒ IEC 60870-5-104 PROTOCOL

<input checked="" type="checkbox"/> IEC 60870-5-104 <input checked="" type="checkbox"/> PROTOCOL		IEC 60870-5-104 FUNCTION: Disabled	Range: Enabled, Disabled
MESSAGE		IEC TCP PORT NUMBER: 2404	Range: 1 to 65535 in steps of 1
MESSAGE		<input checked="" type="checkbox"/> IEC NETWORK <input checked="" type="checkbox"/> CLIENT ADDRESSES	
MESSAGE		IEC COMMON ADDRESS OF ASDU: 0	Range: 0 to 65535 in steps of 1
MESSAGE		IEC CYCLIC DATA PERIOD: 60 s	Range: 1 to 65535 s in steps of 1
MESSAGE		NUMBER OF SOURCES IN MMENC1 LIST: 1	Range: 1 to 6 in steps of 1
MESSAGE		IEC CURRENT DEFAULT THRESHOLD: 30000	Range: 0 to 65535 in steps of 1
MESSAGE		IEC VOLTAGE DEFAULT THRESHOLD: 30000	Range: 0 to 65535 in steps of 1
MESSAGE		IEC POWER DEFAULT THRESHOLD: 30000	Range: 0 to 65535 in steps of 1
MESSAGE		IEC ENERGY DEFAULT THRESHOLD: 30000	Range: 0 to 65535 in steps of 1
MESSAGE		IEC OTHER DEFAULT THRESHOLD: 30000	Range: 0 to 65535 in steps of 1

The F35 supports the IEC 60870-5-104 protocol. The F35 can be used as an IEC 60870-5-104 slave device connected to a maximum of two masters (usually either an RTU or a SCADA master station). Since the F35 maintains two sets of IEC 60870-5-104 data change buffers, no more than two masters should actively communicate with the F35 at one time.

The **NUMBER OF SOURCES IN MMENC1 LIST** setting allows the selection of the number of current/voltage source values that are included in the M_ME_NC_1 (measured value, short floating point) Analog points list. This allows the list to be customized to contain data for only the sources that are configured.

The IEC ----- **DEFAULT THRESHOLD** settings are the values used by the UR to determine when to trigger spontaneous responses containing M_ME_NC_1 analog data. These settings group the UR analog data into types: current, voltage, power, energy, and other. Each setting represents the default threshold value for all M_ME_NC_1 analog points of that type. For example, in order to trigger spontaneous responses from the UR when any current values change by 15 A, the **IEC CURRENT DEFAULT THRESHOLD** setting should be set to 15. Note that these settings are the default values of the dead-bands. P_ME_NC_1 (Parameter of measured value, short floating point value) points can be used to change threshold values, from the default, for each individual M_ME_NC_1 analog point. Whenever power is removed and re-applied to the UR, the default thresholds will be in effect.



NOTE The IEC 60870-5-104 and DNP protocols can not be used at the same time. When the IEC 60870-5-104 FUNCTION setting is set to “Enabled”, the DNP protocol will not be operational. When this setting is changed it will not become active until power to the relay has been cycled (Off/On).

j) SNTP PROTOCOL

PATH: SETTINGS ⇒ PRODUCT SETUP ⇒ COMMUNICATIONS ⇒ SNTP PROTOCOL

<input checked="" type="checkbox"/> SNTP PROTOCOL <input checked="" type="checkbox"/>	◀▶	SNTP FUNCTION: Disabled	Range: Enabled, Disabled
	MESSAGE ▲▼	SNTP SERVER IP ADDR: 0.0.0.0	Range: Standard IP address format
	MESSAGE ▲	SNTP UDP PORT NUMBER: 123	Range: 0 to 65535 in steps of 1

The F35 supports the Simple Network Time Protocol specified in RFC-2030. With SNTP, the F35 can obtain clock time over an Ethernet network. The F35 acts as an SNTP client to receive time values from an SNTP/NTP server, usually a dedicated product using a GPS receiver to provide an accurate time. Both unicast and broadcast SNTP are supported.

If SNTP functionality is enabled at the same time as IRIG-B, the IRIG-B signal provides the time value to the F35 clock for as long as a valid signal is present. If the IRIG-B signal is removed, the time obtained from the SNTP server is used. If either SNTP or IRIG-B is enabled, the F35 clock value cannot be changed using the front panel keypad.

To use SNTP in unicast mode, **SNTP SERVER IP ADDR** must be set to the SNTP/NTP server IP address. Once this address is set and **SNTP FUNCTION** is "Enabled", the F35 attempts to obtain time values from the SNTP/NTP server. Since many time values are obtained and averaged, it generally takes three to four minutes until the F35 clock is closely synchronized with the SNTP/NTP server. It may take up to one minute for the F35 to signal an SNTP self-test error if the server is offline.

To use SNTP in broadcast mode, set the **SNTP SERVER IP ADDR** setting to "0.0.0.0" and **SNTP FUNCTION** to "Enabled". The F35 then listens to SNTP messages sent to the "all ones" broadcast address for the subnet. The F35 waits up to eighteen minutes (>1024 seconds) without receiving an SNTP broadcast message before signaling an SNTP self-test error.

The UR-series relays do not support the multicast or anycast SNTP functionality.

k) EGD PROTOCOL

PATH: SETTINGS ⇒ PRODUCT SETUP ⇒ COMMUNICATIONS ⇒ EGD PROTOCOL

<input checked="" type="checkbox"/> EGD PROTOCOL <input checked="" type="checkbox"/>	◀▶	<input checked="" type="checkbox"/> FAST PROD EXCH 1 <input checked="" type="checkbox"/> CONFIGURATION
	MESSAGE ▲▼	<input checked="" type="checkbox"/> SLOW PROD EXCH 1 <input checked="" type="checkbox"/> CONFIGURATION
	MESSAGE ▲	<input checked="" type="checkbox"/> SLOW PROD EXCH 2 <input checked="" type="checkbox"/> CONFIGURATION



The Ethernet Global Data (EGD) protocol settings are only available if CPU Type 9G or 9H is ordered.

NOTE

The relay supports one fast Ethernet Global Data (EGD) exchange and two slow EGD exchanges. There are 20 data items in the fast-produced EGD exchange and 50 data items in each slow-produced exchange.

Ethernet Global Data (EGD) is a suite of protocols used for the real-time transfer of data for display and control purposes. The relay can be configured to 'produce' EGD data exchanges, and other devices can be configured to 'consume' EGD data exchanges. The number of produced exchanges (up to three), the data items in each exchange (up to 50), and the exchange production rate can be configured.

EGD cannot be used to transfer data between UR-series relays. The relay supports EGD production only. An EGD exchange will not be transmitted unless the destination address is non-zero, and at least the first data item address is set to a valid Modbus register address. Note that the default setting value of "0" is considered invalid.

The settings menu for the fast EGD exchange is shown below:

PATH: SETTINGS ⇒ PRODUCT SETUP ⇒ COMMUNICATIONS ⇒ EGD PROTOCOL ⇒ FAST PROD EXCH 1 CONFIGURATION

<div style="border: 1px solid black; padding: 2px;"> ■ FAST PROD EXCH 1 ■ CONFIGURATION </div>		<div style="border: 1px solid black; padding: 2px;"> EXCH 1 FUNCTION: Disable </div>	Range: Disable, Enable
	MESSAGE	<div style="border: 1px solid black; padding: 2px;"> EXCH 1 DESTINATION: 0.0.0.0 </div>	Range: standard IP address
	MESSAGE	<div style="border: 1px solid black; padding: 2px;"> EXCH 1 DATA RATE: 1000 ms </div>	Range: 50 to 1000 ms in steps of 1
	MESSAGE	<div style="border: 1px solid black; padding: 2px;"> EXCH 1 DATA ITEM 1: 0 </div>	Range: 0 to 65535 in steps of 1 (Modbus register address range)
		↓	
MESSAGE	<div style="border: 1px solid black; padding: 2px;"> EXCH 1 DATA ITEM 20: 0 </div>	Range: 0 to 65535 in steps of 1 (Modbus register address range)	

Fast exchanges (50 to 1000 ms) are generally used in control schemes. The F35 has one fast exchange (Exchange 1) and two slow exchanges (Exchanges 2 and 3).

The settings menu for the slow EGD exchanges is shown below:

PATH: SETTINGS ⇒ PRODUCT SETUP ⇒ COMMUNICATIONS ⇒ EGD PROTOCOL ⇒ SLOW PROD EXCH 1(2) CONFIGURATION

<div style="border: 1px solid black; padding: 2px;"> ■ SLOW PROD EXCH 1 ■ CONFIGURATION </div>		<div style="border: 1px solid black; padding: 2px;"> EXCH 1 FUNCTION: Disable </div>	Range: Disable, Enable
	MESSAGE	<div style="border: 1px solid black; padding: 2px;"> EXCH 1 DESTINATION: 0.0.0.0 </div>	Range: standard IP address
	MESSAGE	<div style="border: 1px solid black; padding: 2px;"> EXCH 1 DATA RATE: 1000 ms </div>	Range: 500 to 1000 ms in steps of 1
	MESSAGE	<div style="border: 1px solid black; padding: 2px;"> EXCH 1 DATA ITEM 1: 0 </div>	Range: 0 to 65535 in steps of 1 (Modbus register address range in decimal)
		↓	
MESSAGE	<div style="border: 1px solid black; padding: 2px;"> EXCH 1 DATA ITEM 50: 0 </div>	Range: 0 to 65535 in steps of 1 (Modbus register address range in decimal)	

Slow EGD exchanges (500 to 1000 ms) are generally used for the transfer and display of data items. The settings for the fast and slow exchanges are described below:

- **EXCH 1 DESTINATION:** This setting specifies the destination IP address of the produced EGD exchange. This is usually unicast or broadcast.
- **EXCH 1 DATA RATE:** This setting specifies the rate at which this EGD exchange is transmitted. If the setting is 50 ms, the exchange data will be updated and sent once every 50 ms. If the setting is 1000 ms, the exchange data will be updated and sent once per second. EGD exchange 1 has a setting range of 50 to 1000 ms. Exchanges 2 and 3 have a setting range of 500 to 1000 ms.
- **EXCH 1 DATA ITEM 1 to 20/50:** These settings specify the data items that are part of this EGD exchange. Almost any data from the F35 memory map can be configured to be included in an EGD exchange. The settings are the starting Modbus register address for the data item in decimal format. Refer to Appendix B for the complete Modbus memory map. Note that the Modbus memory map displays shows addresses in hexadecimal format; as such, it will be necessary to convert these values to decimal format before entering them as values for these setpoints.

To select a data item to be part of an exchange, it is only necessary to choose the starting Modbus address of the item. That is, for items occupying more than one Modbus register (e.g. 32 bit integers and floating point values), only the first Modbus address is required. The EGD exchange configured with these settings contains the data items up to the first setting that contains a Modbus address with no data, or 0. That is, if the first three settings contain valid Modbus addresses and the fourth is 0, the produced EGD exchange will contain three data items.

5.2.5 MODBUS USER MAP

PATH: SETTINGS ⇒ PRODUCT SETUP ⇒ MODBUS USER MAP

<input checked="" type="checkbox"/> MODBUS USER MAP <input checked="" type="checkbox"/>	◀▶	ADDRESS 1: 0 VALUE: 0	Range: 0 to 65535 in steps of 1
		↓	
MESSAGE	▲	ADDRESS 256: 0 VALUE: 0	Range: 0 to 65535 in steps of 1

The Modbus User Map provides read-only access for up to 256 registers. To obtain a memory map value, enter the desired address in the **ADDRESS** line (this value must be converted from hex to decimal format). The corresponding value is displayed in the **VALUE** line. A value of "0" in subsequent register **ADDRESS** lines automatically returns values for the previous **ADDRESS** lines incremented by "1". An address value of "0" in the initial register means "none" and values of "0" will be displayed for all registers. Different **ADDRESS** values can be entered as required in any of the register positions.



These settings can also be used with the DNP protocol. See the DNP Analog Input Points section in Appendix E for details.

5.2.6 REAL TIME CLOCK

PATH: SETTINGS ⇒ PRODUCT SETUP ⇒ REAL TIME CLOCK

<input checked="" type="checkbox"/> REAL TIME <input checked="" type="checkbox"/> CLOCK	◀▶	IRIG-B SIGNAL TYPE: None	Range: None, DC Shift, Amplitude Modulated
MESSAGE	▲	REAL TIME CLOCK EVENTS: Disabled	Range: Disabled, Enabled

The date and time for the relay clock can be synchronized to other relays using an IRIG-B signal. It has the same accuracy as an electronic watch, approximately ± 1 minute per month. An IRIG-B signal may be connected to the relay to synchronize the clock to a known time base and to other relays. If an IRIG-B signal is used, only the current year needs to be entered. See also the **COMMANDS** ⇒ SET DATE AND TIME menu for manually setting the relay clock.

The **REAL TIME CLOCK EVENTS** setting allows changes to the date and/or time to be captured in the event record.

5.2.7 FAULT REPORTS

PATH: SETTINGS ⇒ PRODUCT SETUP ⇒ ↓ FAULT REPORTS ⇒ FAULT REPORT 1(5)

■ FAULT REPORT 1	◀▶	FAULT REPORT 1 SOURCE: SRC 1	Range: SRC 1, SRC 2, SRC 3, SRC 4, SRC 5, SRC 6
MESSAGE	▲▼	FAULT REPORT 1 TRIG: Off	Range: FlexLogic™ operand
MESSAGE	▲▼	FAULT REPORT 1 Z1 MAG: 3.00 Ω	Range: 0.01 to 250.00 Ω in steps of 0.01
MESSAGE	▲▼	FAULT REPORT 1 Z1 ANGLE: 75°	Range: 25 to 90° in steps of 1
MESSAGE	▲▼	FAULT REPORT 1 Z0 MAG: 9.00 Ω	Range: 0.01 to 650.00 Ω in steps of 0.01
MESSAGE	▲▼	FAULT REPORT 1 Z0 ANGLE: 75°	Range: 25 to 90° in steps of 1
MESSAGE	▲▼	FAULT REPORT 1 LINE LENGTH UNITS: km	Range: km, miles
MESSAGE	▲	FAULT REP 1 LENGTH (km): 100.0	Range: 0.0 to 2000.0 in steps of 0.1

5

The F35 relay supports one fault report and an associated fault locator per CT bank to a maximum of 5. The signal source and trigger condition, as well as the characteristics of the line or feeder, are entered in this menu.

The fault report stores data, in non-volatile memory, pertinent to an event when triggered. The captured data contained in the `FaultReport.txt` file includes:

- Fault report number
- Name of the relay, programmed by the user
- Firmware revision of the relay
- Date and time of trigger
- Name of trigger (specific operand)
- Line/Feeder ID via the name of a configured signal source
- Active setting group at the time of trigger
- Pre-fault current and voltage phasors (one-quarter cycle before the trigger)
- Fault current and voltage phasors (three-quarter cycle after the trigger)
- Elements operated at the time of triggering
- Events: 9 before trigger and 7 after trigger (only available via the relay webpage)

The captured data also includes the fault type and the distance to the fault location, as well as the reclose shot number (when applicable) The Fault Locator does not report fault type or location if the source VTs are connected in the Delta configuration.

The trigger can be any FlexLogic™ operand, but in most applications it is expected to be the same operand, usually a virtual output, that is used to drive an output relay to trip a breaker. To prevent the overwriting of fault events, the disturbance detector should not be used to trigger a fault report. A FAULT RPT TRIG event is automatically created when the report is triggered.

If a number of protection elements are ORed to create a fault report trigger, the first operation of any element causing the OR gate output to become high triggers a fault report. However, If other elements operate during the fault and the first operated element has not been reset (the OR gate output is still high), the fault report is not triggered again. Considering the reset time of protection elements, there is very little chance that fault report can be triggered twice in this manner. As the fault report must capture a usable amount of pre and post-fault data, it can not be triggered faster than every 20 ms.

Each fault report is stored as a file; the relay capacity is fifteen (15) files. An sixteenth (16th) trigger overwrites the oldest file. Individual fault report features store their files in the same memory space. The sixteenth report will overwrite the first one regardless which fault report feature produced the sixteenth and the first records.

The enerVista UR Setup software is required to view all captured data. The relay faceplate display can be used to view the date and time of trigger, the fault type, the distance location of the fault, and the reclose shot number.

The **FAULT REPORT 1(5) SOURCE** setting selects the source for input currents and voltages and disturbance detection. The **FAULT 1(5) REPORT TRIG** setting assigns the FlexLogic™ operand representing the protection element/elements requiring operational fault location calculations. The distance to fault calculations are initiated by this signal. The **FAULT REPORT 1(5) Z1 MAG** and **FAULT REPORT 1(5) Z0 MAG** impedances are entered in secondary ohms.

See the **ACTUAL VALUES** ⇒ **RECORDS** ⇒ **FAULT REPORTS** menu for additional details.

5.2.8 OSCILLOGRAPHY

a) MAIN MENU

PATH: **SETTINGS** ⇒ **PRODUCT SETUP** ⇒ **OSCILLOGRAPHY**

<input checked="" type="checkbox"/> OSCILLOGRAPHY <input type="checkbox"/>	◀▶	NUMBER OF RECORDS: 15	<i>Range: 1 to 64 in steps of 1</i>
<i>MESSAGE</i>	▲▼	TRIGGER MODE: Automatic Overwrite	<i>Range: Automatic Overwrite, Protected</i>
<i>MESSAGE</i>	▲▼	TRIGGER POSITION: 50%	<i>Range: 0 to 100% in steps of 1</i>
<i>MESSAGE</i>	▲▼	TRIGGER SOURCE: Off	<i>Range: FlexLogic™ operand</i>
<i>MESSAGE</i>	▲▼	AC INPUT WAVEFORMS: 16 samples/cycle	<i>Range: Off, 8, 16, 32, 64 samples/cycle</i>
<i>MESSAGE</i>	▲▼	<input checked="" type="checkbox"/> DIGITAL CHANNELS <input type="checkbox"/>	
<i>MESSAGE</i>	▲	<input checked="" type="checkbox"/> ANALOG CHANNELS <input type="checkbox"/>	



Oscillography records contain waveforms captured at the sampling rate as well as other relay data at the point of trigger. Oscillography records are triggered by a programmable FlexLogic™ operand. Multiple oscillography records may be captured simultaneously.

The **NUMBER OF RECORDS** is selectable, but the number of cycles captured in a single record varies considerably based on other factors such as sample rate and the number of operational CT/VT modules. There is a fixed amount of data storage for oscillography; the more data captured, the less the number of cycles captured per record. See the **ACTUAL VALUES** ⇒ **RECORDS** ⇒ **OSCILLOGRAPHY** menu to view the number of cycles captured per record. The following table provides sample configurations with corresponding cycles/record.

Table 5–1: OSCILLOGRAPHY CYCLES/RECORD EXAMPLE

# RECORDS	# CT/VTS	SAMPLE RATE	# DIGITALS	# ANALOGS	CYCLES/RECORD
1	1	8	0	0	1872.0
1	1	16	16	0	1685.0
8	1	16	16	0	276.0
8	1	16	16	4	219.5
8	2	16	16	4	93.5
8	2	16	64	16	93.5
8	2	32	64	16	57.6
8	2	64	64	16	32.3
32	2	64	64	16	9.5

A new record may automatically overwrite an older record if **TRIGGER MODE** is set to “Automatic Overwrite”.

Set the **TRIGGER POSITION** to a percentage of the total buffer size (e.g. 10%, 50%, 75%, etc.). A trigger position of 25% consists of 25% pre- and 75% post-trigger data. The **TRIGGER SOURCE** is always captured in oscillography and may be any FlexLogic™ parameter (element state, contact input, virtual output, etc.). The relay sampling rate is 64 samples per cycle.

The **AC INPUT WAVEFORMS** setting determines the sampling rate at which AC input signals (i.e. current and voltage) are stored. Reducing the sampling rate allows longer records to be stored. This setting has no effect on the internal sampling rate of the relay which is always 64 samples per cycle, i.e. it has no effect on the fundamental calculations of the device.



When changes are made to the oscillography settings, all existing oscillography records will be CLEARED.

b) DIGITAL CHANNELS

PATH: SETTINGS ⇒ PRODUCT SETUP ⇒ OSCILLOGRAPHY ⇒ DIGITAL CHANNELS

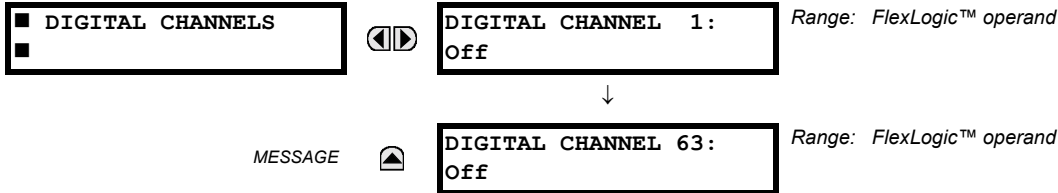

A **DIGITAL CHANNEL** setting selects the FlexLogic™ operand state recorded in an oscillography trace. The length of each oscillography trace depends in part on the number of parameters selected here. Parameters set to “Off” are ignored. Upon startup, the relay will automatically prepare the parameter list.

c) ANALOG CHANNELS

PATH: SETTINGS ⇒ PRODUCT SETUP ⇒ OSCILLOGRAPHY ⇒ ANALOG CHANNELS

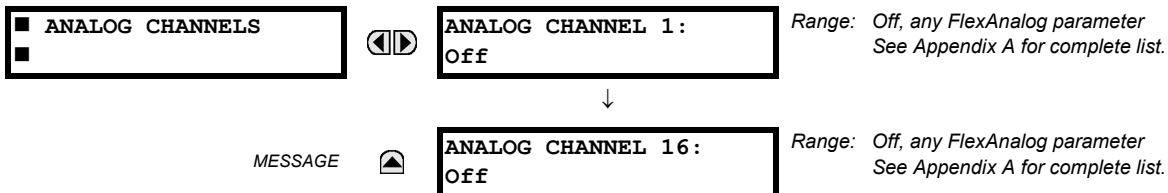

An **ANALOG CHANNEL** setting selects the metering actual value recorded in an oscillography trace. The length of each oscillography trace depends in part on the number of parameters selected here. Parameters set to “Off” are ignored. The parameters available in a given relay are dependent on: (a) the type of relay, (b) the type and number of CT/VT hardware modules installed, and (c) the type and number of Analog Input hardware modules installed. Upon startup, the relay will automatically prepare the parameter list. A list of all possible analog metering actual value parameters is presented in Appendix A: *FlexAnalog Parameters*. The parameter index number shown in any of the tables is used to expedite the selection of the parameter on the relay display. It can be quite time-consuming to scan through the list of parameters via the relay keypad/display - entering this number via the relay keypad will cause the corresponding parameter to be displayed.

All eight CT/VT module channels are stored in the oscillography file. The CT/VT module channels are named as follows:

`<slot_letter><terminal_number>—<I or V><phase A, B, or C, or 4th input>`

The fourth current input in a bank is called IG, and the fourth voltage input in a bank is called VX. For example, F2-IB designates the IB signal on Terminal 2 of the CT/VT module in slot F. If there are no CT/VT modules and Analog Input modules, no analog traces will appear in the file; only the digital traces will appear.



The source harmonic indices appear as oscillography analog channels numbered from 0 to 23. These correspond directly to the 2nd to 25th harmonics in the relay as follows:

Analog channel 0 ↔ 2nd harmonic
 Analog channel 1 ↔ 3rd harmonic
 ...
 Analog channel 23 ↔ 25th harmonic

5.2.9 DATA LOGGER

PATH: SETTINGS ⇒ PRODUCT SETUP ⇒ DATA LOGGER

■ DATA LOGGER	◀▶	DATA LOGGER RATE: 1 min	Range: 1 sec; 1 min, 5 min, 10 min, 15 min, 20 min, 30 min, 60 min
MESSAGE	▲▼	DATA LOGGER CHNL 1: Off	Range: Off, any FlexAnalog parameter. See Appendix A: FlexAnalog Parameters for complete list.
MESSAGE	▲▼	DATA LOGGER CHNL 2: Off	Range: Off, any FlexAnalog parameter. See Appendix A: FlexAnalog Parameters for complete list.
	↓		
MESSAGE	▲▼	DATA LOGGER CHNL 16: Off	Range: Off, any FlexAnalog parameter. See Appendix A: FlexAnalog Parameters for complete list.
MESSAGE	▲	DATA LOGGER CONFIG: 0 CHNL x 0.0 DAYS	Range: Not applicable - shows computed data only

The data logger samples and records up to 16 analog parameters at a user-defined sampling rate. This recorded data may be downloaded to the enerVista UR Setup software and displayed with 'parameters' on the vertical axis and 'time' on the horizontal axis. All data is stored in non-volatile memory, meaning that the information is retained when power to the relay is lost.

For a fixed sampling rate, the data logger can be configured with a few channels over a long period or a larger number of channels for a shorter period. The relay automatically partitions the available memory between the channels in use.



Changing any setting affecting Data Logger operation will clear any data that is currently in the log.

- **DATA LOGGER RATE:** This setting selects the time interval at which the actual value data will be recorded.
- **DATA LOGGER CHNL 1(16):** This setting selects the metering actual value that is to be recorded in Channel 1(16) of the data log. The parameters available in a given relay are dependent on: the type of relay, the type and number of CT/VT hardware modules installed, and the type and number of Analog Input hardware modules installed. Upon startup, the relay will automatically prepare the parameter list. A list of all possible analog metering actual value parameters is shown in Appendix A: FlexAnalog Parameters. The parameter index number shown in any of the tables is used to expedite the selection of the parameter on the relay display. It can be quite time-consuming to scan through the list of parameters via the relay keypad/display – entering this number via the relay keypad will cause the corresponding parameter to be displayed.
- **DATA LOGGER CONFIG:** This display presents the total amount of time the Data Logger can record the channels not selected to "Off" without over-writing old data.

PATH: SETTINGS ⇒ PRODUCT SETUP ⇒ DEMAND

■ DEMAND	◀▶	CRNT DEMAND METHOD: Thermal Exponential	Range: Thermal Exponential, Block Interval, Rolling Demand
MESSAGE	▲▼	POWER DEMAND METHOD: Thermal Exponential	Range: Thermal Exponential, Block Interval, Rolling Demand
MESSAGE	▲▼	DEMAND INTERVAL: 15 MIN	Range: 5, 10, 15, 20, 30, 60 minutes
MESSAGE	▲	DEMAND TRIGGER: Off	Range: FlexLogic™ operand Note: for calculation using Method 2a

The relay measures current demand on each phase, and three-phase demand for real, reactive, and apparent power. Current and Power methods can be chosen separately for the convenience of the user. Settings are provided to allow the user to emulate some common electrical utility demand measuring techniques, for statistical or control purposes. If the **CRNT DEMAND METHOD** is set to "Block Interval" and the **DEMAND TRIGGER** is set to "Off", Method 2 is used (see below). If **DEMAND TRIGGER** is assigned to any other FlexLogic™ operand, Method 2a is used (see below).

The relay can be set to calculate demand by any of three methods as described below:

CALCULATION METHOD 1: THERMAL EXPONENTIAL

This method emulates the action of an analog peak recording thermal demand meter. The relay measures the quantity (RMS current, real power, reactive power, or apparent power) on each phase every second, and assumes the circuit quantity remains at this value until updated by the next measurement. It calculates the 'thermal demand equivalent' based on the following equation:

$$d(t) = D(1 - e^{-kt}) \quad (\text{EQ 5.4})$$

where: d = demand value after applying input quantity for time t (in minutes)
 D = input quantity (constant), and $k = 2.3 / \text{thermal 90\% response time}$.

The 90% thermal response time characteristic of 15 minutes is illustrated below. A setpoint establishes the time to reach 90% of a steady-state value, just as the response time of an analog instrument. A steady state value applied for twice the response time will indicate 99% of the value.

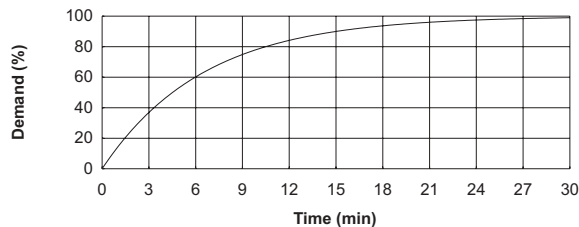

Figure 5-2: THERMAL DEMAND CHARACTERISTIC

CALCULATION METHOD 2: BLOCK INTERVAL

This method calculates a linear average of the quantity (RMS current, real power, reactive power, or apparent power) over the programmed demand time interval, starting daily at 00:00:00 (i.e. 12:00 am). The 1440 minutes per day is divided into the number of blocks as set by the programmed time interval. Each new value of demand becomes available at the end of each time interval.

CALCULATION METHOD 2a: BLOCK INTERVAL (with Start Demand Interval Logic Trigger)

This method calculates a linear average of the quantity (RMS current, real power, reactive power, or apparent power) over the interval between successive Start Demand Interval logic input pulses. Each new value of demand becomes available at the end of each pulse. Assign a FlexLogic™ operand to the **DEMAND TRIGGER** setting to program the input for the new demand interval pulses.



If no trigger is assigned in the **DEMAND TRIGGER** setting and the **CRNT DEMAND METHOD** is "Block Interval", use calculating method #2. If a trigger is assigned, the maximum allowed time between 2 trigger signals is 60 minutes. If no trigger signal appears within 60 minutes, demand calculations are performed and available and the algorithm resets and starts the new cycle of calculations. The minimum required time for trigger contact closure is 20 μ s.

CALCULATION METHOD 3: ROLLING DEMAND

This method calculates a linear average of the quantity (RMS current, real power, reactive power, or apparent power) over the programmed demand time interval, in the same way as Block Interval. The value is updated every minute and indicates the demand over the time interval just preceding the time of update.

5.2.11 USER-PROGRAMMABLE LEDES

a) MAIN MENU

PATH: SETTINGS \Rightarrow PRODUCT SETUP \Rightarrow USER-PROGRAMMABLE LEDES

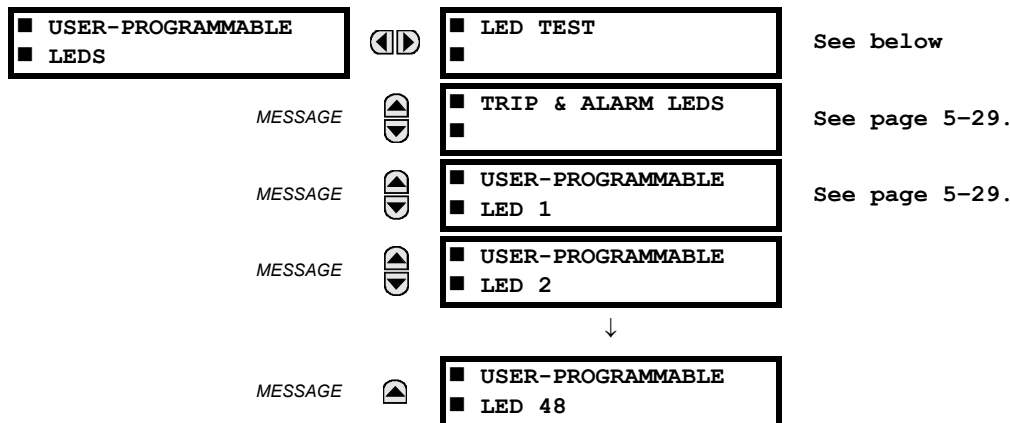

b) LED TEST

PATH: SETTINGS \Rightarrow PRODUCT SETUP \Rightarrow USER-PROGRAMMABLE LEDES \Rightarrow LED TEST

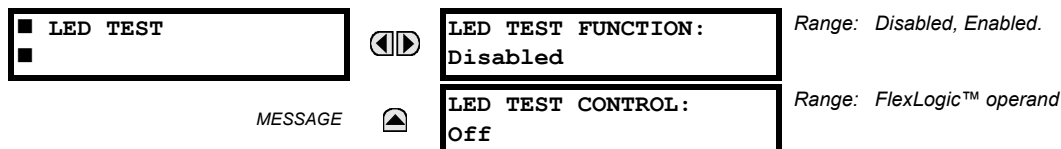

When enabled, the LED Test can be initiated from any digital input or user-programmable condition such as user-programmable pushbutton. The control operand is configured under the **LED TEST CONTROL** setting. The test covers all LEDs, including the LEDs of the optional user-programmable pushbuttons.

The test consists of three stages.

Stage 1: All 62 LEDs on the relay are illuminated. This is a quick test to verify if any of the LEDs is "burned". This stage lasts as long as the control input is on, up to a maximum of 1 minute. After 1 minute, the test will end.

Stage 2: All the LEDs are turned off, and then one LED at a time turns on for 1 second, then back off. The test routine starts at the top left panel, moving from the top to bottom of each LED column. This test checks for hardware failures that lead to more than one LED being turned on from a single logic point. This stage can be interrupted at any time.

Stage 3: All the LEDs are turned on. One LED at a time turns off for 1 second, then back on. The test routine starts at the top left panel moving from top to bottom of each column of the LEDs. This test checks for hardware failures that lead to more than one LED being turned off from a single logic point. This stage can be interrupted at any time.

When testing is in progress, the LEDs are controlled by the test sequence, rather than the protection, control, and monitoring features. However, the LED control mechanism accepts all the changes to LED states generated by the relay and stores the actual LED states (On or Off) in memory. When the test completes, the LEDs reflect the actual state resulting from relay response during testing. The Reset pushbutton will not clear any targets when the LED Test is in progress.

A dedicated FlexLogic™ operand, LED TEST IN PROGRESS, is set for the duration of the test. When the test sequence is initiated, the LED Test Initiated event is stored in the Event Recorder.

The entire test procedure is user-controlled. In particular, Stage 1 can last as long as necessary, and Stages 2 and 3 can be interrupted. The test responds to the position and rising edges of the control input defined by the LED TEST CONTROL setting. The control pulses must last at least 250 ms to take effect. The following diagram explains how the test is executed.

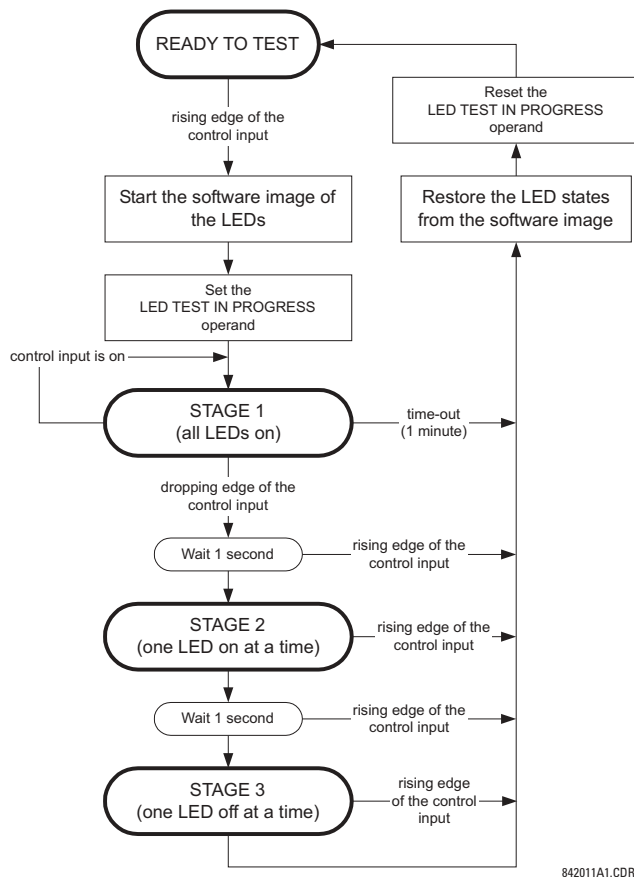

Figure 5–3: LED TEST SEQUENCE

APPLICATION EXAMPLE 1:

Assume one needs to check if any of the LEDs is “burned” through User-Programmable Pushbutton 1. The following settings should be applied. Configure User-Programmable Pushbutton 1 by making the following entries in the **SETTINGS** ⇒ **PRODUCT SETUP** ⇒ **USER-PROGRAMMABLE PUSHBUTTONS** ⇒ **USER PUSHBUTTON 1** menu:

PUSHBUTTON 1 FUNCTION: “Self-reset”
PUSHBTN 1 DROP-OUT TIME: “0.10 s”

Configure the LED test to recognize User-Programmable Pushbutton 1 by making the following entries in the **SETTINGS** ⇒ **PRODUCT SETUP** ⇒ **USER-PROGRAMMABLE LEDs** ⇒ **LED TEST** menu:

LED TEST FUNCTION: “Enabled”
LED TEST CONTROL: “PUSHBUTTON 1 ON”

The test will be initiated when the User-Programmable Pushbutton 1 is pressed. The pushbutton should remain pressed for as long as the LEDs are being visually inspected. When finished, the pushbutton should be released. The relay will then automatically start Stage 2. At this point forward, test may be aborted by pressing the pushbutton.

APPLICATION EXAMPLE 2:

Assume one needs to check if any LEDs are “burned” as well as exercise one LED at a time to check for other failures. This is to be performed via User-Programmable Pushbutton 1.

After applying the settings in Application Example 1, hold down the pushbutton as long as necessary to test all LEDs. Next, release the pushbutton to automatically start Stage 2. Once Stage 2 has started, the pushbutton can be released. When Stage 2 is completed, Stage 3 will automatically start. The test may be aborted at any time by pressing the pushbutton.

c) TRIP AND ALARM LEDES

PATH: SETTINGS ⇒ PRODUCT SETUP ⇒ USER-PROGRAMMABLE LEDES ⇒ TRIP & ALARM LEDES

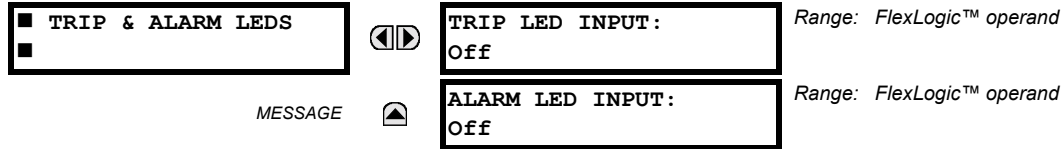

The Trip and Alarm LEDs are on LED Panel 1. Each indicator can be programmed to become illuminated when the selected FlexLogic™ operand is in the Logic 1 state.

d) USER-PROGRAMMABLE LED 1(48)

PATH: SETTINGS ⇒ PRODUCT SETUP ⇒ USER-PROGRAMMABLE LEDES ⇒ USER-PROGRAMMABLE LED 1(48)

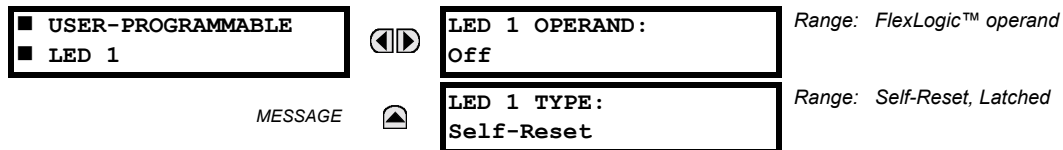

There are 48 amber LEDs across the relay faceplate LED panels. Each of these indicators can be programmed to illuminate when the selected FlexLogic™ operand is in the Logic 1 state.

- LEDs 1 through 24 inclusive are on LED Panel 2; LEDs 25 through 48 inclusive are on LED Panel 3.

Refer to the LED Indicators section in Chapter 4 for the locations of these indexed LEDs. This menu selects the operands to control these LEDs. Support for applying user-customized labels to these LEDs is provided. If the **LED X TYPE** setting is "Self-Reset" (default setting), the LED illumination will track the state of the selected LED operand. If the **LED X TYPE** setting is 'Latched', the LED, once lit, remains so until reset by the faceplate RESET button, from a remote device via a communications channel, or from any programmed operand, even if the LED operand state de-asserts.

Table 5–2: RECOMMENDED SETTINGS FOR LED PANEL 2 LABELS

SETTING	PARAMETER	SETTING	PARAMETER
LED 1 Operand	SETTING GROUP ACT 1	LED 13 Operand	Off
LED 2 Operand	SETTING GROUP ACT 2	LED 14 Operand	BREAKER 2 OPEN
LED 3 Operand	SETTING GROUP ACT 3	LED 15 Operand	BREAKER 2 CLOSED
LED 4 Operand	SETTING GROUP ACT 4	LED 16 Operand	BREAKER 2 TROUBLE
LED 5 Operand	SETTING GROUP ACT 5	LED 17 Operand	SYNC 1 SYNC OP
LED 6 Operand	SETTING GROUP ACT 6	LED 18 Operand	SYNC 2 SYNC OP
LED 7 Operand	Off	LED 19 Operand	Off
LED 8 Operand	Off	LED 20 Operand	Off
LED 9 Operand	BREAKER 1 OPEN	LED 21 Operand	AR ENABLED
LED 10 Operand	BREAKER 1 CLOSED	LED 22 Operand	AR DISABLED
LED 11 Operand	BREAKER 1 TROUBLE	LED 23 Operand	AR RIP
LED 12 Operand	Off	LED 24 Operand	AR LO

Refer to the *Control of Setting Groups* example in the *Control Elements* section of this chapter for group activation.

5.2.12 USER-PROGRAMMABLE SELF TESTS

PATH: SETTINGS ⇒ PRODUCT SETUP ⇒ USER-PROGRAMMABLE SELF TESTS

<div style="border: 1px solid black; padding: 2px;"> ■ USER-PROGRAMMABLE ■ SELF TESTS </div>		<div style="border: 1px solid black; padding: 2px;"> DIRECT RING BREAK FUNCTION: Enabled </div>	Range: Disabled, Enabled. Valid for units equipped with Direct I/O Module.
MESSAGE	▲▼	<div style="border: 1px solid black; padding: 2px;"> DIRECT DEVICE OFF FUNCTION: Enabled </div>	Range: Disabled, Enabled. Valid for units equipped with Direct I/O Module.
MESSAGE	▲▼	<div style="border: 1px solid black; padding: 2px;"> REMOTE DEVICE OFF FUNCTION: Enabled </div>	Range: Disabled, Enabled. Valid for units equipped with CPU Type C or D.
MESSAGE	▲▼	<div style="border: 1px solid black; padding: 2px;"> PRI. ETHERNET FAIL FUNCTION: Disabled </div>	Range: Disabled, Enabled. Valid for units equipped with CPU Type C or D.
MESSAGE	▲▼	<div style="border: 1px solid black; padding: 2px;"> SEC. ETHERNET FAIL FUNCTION: Disabled </div>	Range: Disabled, Enabled. Valid for units equipped with CPU Type D.
MESSAGE	▲▼	<div style="border: 1px solid black; padding: 2px;"> BATTERY FAIL FUNCTION: Enabled </div>	Range: Disabled, Enabled.
MESSAGE	▲▼	<div style="border: 1px solid black; padding: 2px;"> SNTP FAIL FUNCTION: Enabled </div>	Range: Disabled, Enabled. Valid for units equipped with CPU Type C or D.
MESSAGE	▲	<div style="border: 1px solid black; padding: 2px;"> IRIG-B FAIL FUNCTION: Enabled </div>	Range: Disabled, Enabled.

5

All major self-test alarms are reported automatically with their corresponding FlexLogic™ operands, events, and targets. Most of the Minor Alarms can be disabled if desired.

When in the “Disabled” mode, minor alarms will not assert a FlexLogic™ operand, write to the event recorder, display target messages. Moreover, they will not trigger the **ANY MINOR ALARM** or **ANY SELF-TEST** messages. When in the “Enabled” mode, minor alarms continue to function along with other major and minor alarms. Refer to the Relay Self-Tests section in Chapter 7 for additional information on major and minor self-test alarms.

5.2.13 CONTROL PUSHBUTTONS

PATH: SETTINGS ⇒ PRODUCT SETUP ⇒ CONTROL PUSHBUTTONS ⇒ CONTROL PUSHBUTTON 1(7)

<div style="border: 1px solid black; padding: 2px;"> ■ CONTROL ■ PUSHBUTTON 1 </div>		<div style="border: 1px solid black; padding: 2px;"> CONTROL PUSHBUTTON 1 FUNCTION: Disabled </div>	Range: Disabled, Enabled
MESSAGE	▲	<div style="border: 1px solid black; padding: 2px;"> CONTROL PUSHBUTTON 1 EVENTS: Disabled </div>	Range: Disabled, Enabled

The three standard pushbuttons located on the top left panel of the faceplate are user-programmable and can be used for various applications such as performing an LED test, switching setting groups, and invoking and scrolling through user-programmable displays, etc. The location of the control pushbuttons in the following figure.

An additional four control pushbuttons are included when the F35 is ordered with twelve user programmable pushbuttons.

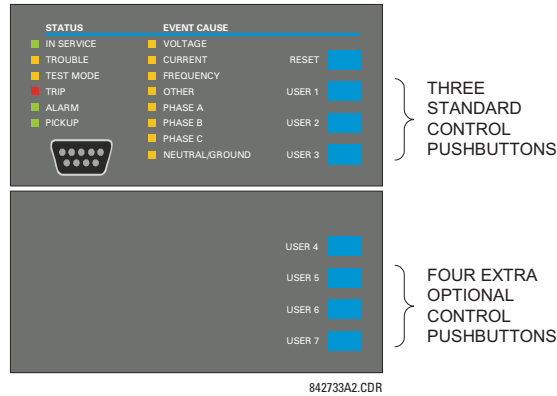

Figure 5-4: CONTROL PUSHBUTTONS

The control pushbuttons are typically not used for critical operations. As such, they are not protected by the control password. However, by supervising their output operands, the user can dynamically enable or disable the control pushbuttons for security reasons.

Each control pushbutton asserts its own FlexLogic™ operand, CONTROL PUSHBTN 1(7) ON. These operands should be configured appropriately to perform the desired function. The operand remains asserted as long as the pushbutton is pressed and resets when the pushbutton is released. A dropout delay of 100 ms is incorporated to ensure fast pushbutton manipulation will be recognized by various features that may use control pushbuttons as inputs.

An event is logged in the Event Record (as per user setting) when a control pushbutton is pressed; no event is logged when the pushbutton is released. The faceplate keys (including control keys) cannot be operated simultaneously – a given key must be released before the next one can be pressed.

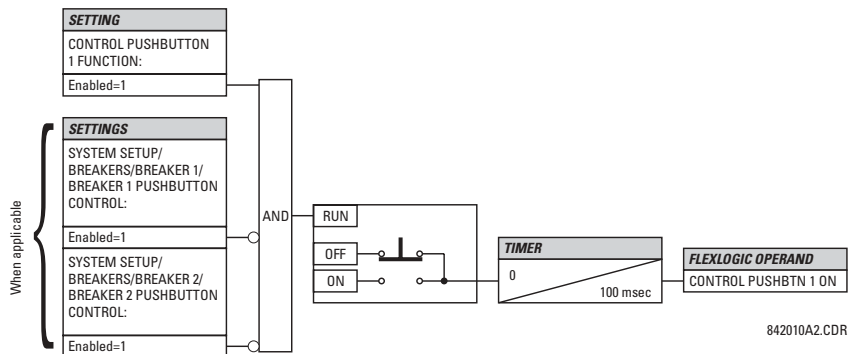

Figure 5-5: CONTROL PUSHBUTTON LOGIC

5.2.14 USER-PROGRAMMABLE PUSHBUTTONS

PATH: SETTINGS ⇒ PRODUCT SETUP ⇒ USER-PROGRAMMABLE PUSHBUTTONS ⇒ USER PUSHBUTTON 1(12)

■ USER PUSHBUTTON 1	◀▶	PUSHBUTTON 1 FUNCTION: Disabled	Range: Self-Reset, Latched, Disabled
MESSAGE	▲▼	PUSHBTN 1 ID TEXT:	Range: Up to 20 alphanumeric characters
MESSAGE	▲▼	PUSHBTN 1 ON TEXT:	Range: Up to 20 alphanumeric characters
MESSAGE	▲▼	PUSHBTN 1 OFF TEXT:	Range: Up to 20 alphanumeric characters
MESSAGE	▲▼	PUSHBTN 1 DROP-OUT TIME: 0.00 s	Range: 0 to 60.00 s in steps of 0.01
MESSAGE	▲▼	PUSHBUTTON 1 TARGETS: Disabled	Range: Self-Reset, Latched, Disabled
MESSAGE	▲	PUSHBUTTON 1 EVENTS: Disabled	Range: Disabled, Enabled

The F35 has 12 optional user-programmable pushbuttons available, each configured via 12 identical menus. The pushbuttons provide an easy and error-free method of manually entering digital information (On, Off) into FlexLogic™ equations as well as protection and control elements. Typical applications include breaker control, autorecloser blocking, ground protection blocking, and setting groups changes.

The user-configurable pushbuttons are shown below. They can be custom labeled with a factory-provided template, available online at <http://www.GEindustrial.com/multilin>.



Figure 5-6: USER-PROGRAMMABLE PUSHBUTTONS

Each pushbutton asserts its own On and Off FlexLogic™ operands, respectively. FlexLogic™ operands should be used to program desired pushbutton actions. The operand names are PUSHBUTTON 1 ON and PUSHBUTTON 1 OFF.

A pushbutton may be programmed to latch or self-reset. An indicating LED next to each pushbutton signals the present status of the corresponding "On" FlexLogic™ operand. When set to "Latched", the state of each pushbutton is stored in non-volatile memory which is maintained during any supply power loss.

Pushbuttons states can be logged by the Event Recorder and displayed as target messages. User-defined messages can also be associated with each pushbutton and displayed when the pushbutton is ON.

- PUSHBUTTON 1 FUNCTION:** This setting selects the characteristic of the pushbutton. If set to "Disabled", the pushbutton is deactivated and the corresponding FlexLogic™ operands (both "On" and "Off") are de-asserted. If set to "Self-reset", the control logic of the pushbutton asserts the "On" corresponding FlexLogic™ operand as long as the pushbutton is being pressed. As soon as the pushbutton is released, the FlexLogic™ operand is de-asserted. The "Off" operand is asserted/de-asserted accordingly.

If set to "Latched", the control logic alternates the state of the corresponding FlexLogic™ operand between "On" and "Off" on each push of the button. When operating in "Latched" mode, FlexLogic™ operand states are stored in non-volatile memory. Should power be lost, the correct pushbutton state is retained upon subsequent power up of the relay.

- **PUSHBTN 1 ID TEXT:** This setting specifies the top 20-character line of the user-programmable message and is intended to provide ID information of the pushbutton. Refer to the User-Definable Displays section for instructions on how to enter alphanumeric characters from the keypad.
- **PUSHBTN 1 ON TEXT:** This setting specifies the bottom 20-character line of the user-programmable message and is displayed when the pushbutton is in the “on” position. Refer to the User-Definable Displays section for instructions on entering alphanumeric characters from the keypad.
- **PUSHBTN 1 OFF TEXT:** This setting specifies the bottom 20-character line of the user-programmable message and is displayed when the pushbutton is activated from the On to the Off position and the **PUSHBUTTON 1 FUNCTION** is “Latched”. This message is not displayed when the **PUSHBUTTON 1 FUNCTION** is “Self-reset” as the pushbutton operand status is implied to be “Off” upon its release. All user text messaging durations for the pushbuttons are configured with the **PRODUCT SETUP** ⇒ **DISPLAY PROPERTIES** ⇒ **FLASH MESSAGE TIME** setting.
- **PUSHBTN 1 DROP-OUT TIME:** This setting specifies a drop-out time delay for a pushbutton in the self-reset mode. A typical applications for this setting is providing a select-before-operate functionality. The selecting pushbutton should have the drop-out time set to a desired value. The operating pushbutton should be logically ANDed with the selecting pushbutton in FlexLogic™. The selecting pushbutton LED remains on for the duration of the drop-out time, signaling the time window for the intended operation.

For example, consider a relay with the following settings: **PUSHBTN 1 ID TEXT:** “AUTORECLOSER”, **PUSHBTN 1 ON TEXT:** “DISABLED - CALL 2199”, and **PUSHBTN 1 OFF TEXT:** “ENABLED”. When Pushbutton 1 changes its state to the “On” position, the following **AUTOCLOSER DISABLED – Call 2199** message is displayed: When Pushbutton 1 changes its state to the “Off” position, the message will change to **AUTORECLOSER ENABLED**.



User-programmable pushbuttons require a type HP relay faceplate. If an HP-type faceplate was ordered separately, the relay order code must be changed to indicate the HP faceplate option. This can be done via enerVista UR Setup with the **Maintenance > Enable Pushbutton** command.

5.2.15 FLEX STATE PARAMETERS

PATH: **SETTINGS** ⇒ **PRODUCT SETUP** ⇒ **FLEX STATE PARAMETERS**

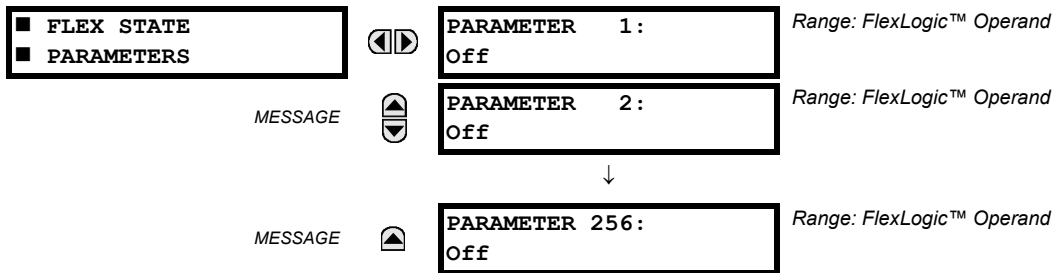

This feature provides a mechanism where any of 256 selected FlexLogic™ operand states can be used for efficient monitoring. The feature allows user-customized access to the FlexLogic™ operand states in the relay. The state bits are packed so that 16 states may be read out in a single Modbus register. The state bits can be configured so that all of the states which are of interest to the user are available in a minimum number of Modbus registers.

The state bits may be read out in the "Flex States" register array beginning at Modbus address 900 hex. 16 states are packed into each register, with the lowest-numbered state in the lowest-order bit. There are 16 registers in total to accommodate the 256 state bits.

5.2.16 USER-DEFINABLE DISPLAYS

a) MAIN MENU

PATH: SETTINGS ⇒ PRODUCT SETUP ⇒ USER-DEFINABLE DISPLAYS

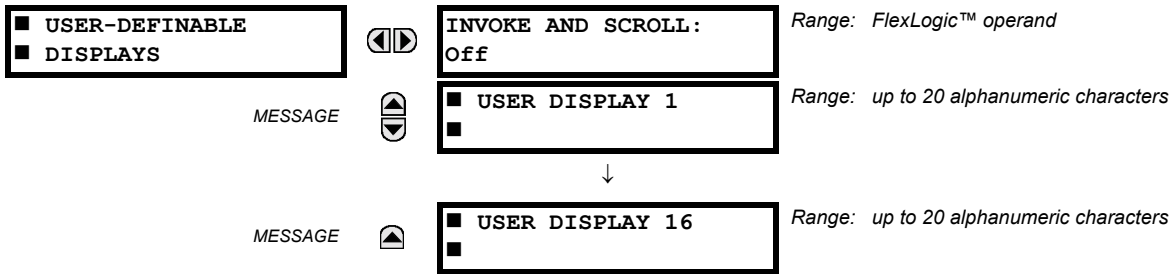

This menu provides a mechanism for manually creating up to 16 user-defined information displays in a convenient viewing sequence in the **USER DISPLAYS** menu (between the **TARGETS** and **ACTUAL VALUES** top-level menus). The sub-menus facilitate text entry and Modbus Register data pointer options for defining the User Display content.

Once programmed, the user-definable displays can be viewed in two ways.

- **KEYPAD:** Use the Menu key to select the **USER DISPLAYS** menu item to access the first user-definable display (note that only the programmed screens are displayed). The screens can be scrolled using the Up and Down keys. The display disappears after the default message time-out period specified by the **PRODUCT SETUP** ⇒ **DISPLAY PROPERTIES** ⇒ **DEFAULT MESSAGE TIMEOUT** setting.
- **USER-PROGRAMMABLE CONTROL INPUT:** The user-definable displays also respond to the **INVOKE AND SCROLL** setting. Any FlexLogic™ operand (in particular, the user-programmable pushbutton operands), can be used to navigate the programmed displays.

On the rising edge of the configured operand (such as when the pushbutton is pressed), the displays are invoked by showing the last user-definable display shown during the previous activity. From this moment onward, the operand acts exactly as the Down key and allows scrolling through the configured displays. The last display wraps up to the first one. The **INVOKE AND SCROLL** input and the Down keypad key operate concurrently.

When the default timer expires (set by the **DEFAULT MESSAGE TIMEOUT** setting), the relay will start to cycle through the user displays. The next activity of the **INVOKE AND SCROLL** input stops the cycling at the currently displayed user display, not at the first user-defined display. The **INVOKE AND SCROLL** pulses must last for at least 250 ms to take effect.

b) USER DISPLAY 1(16)

PATH: SETTINGS ⇒ PRODUCT SETUP ⇒ USER-DEFINABLE DISPLAYS ⇒ USER DISPLAY 1(16)

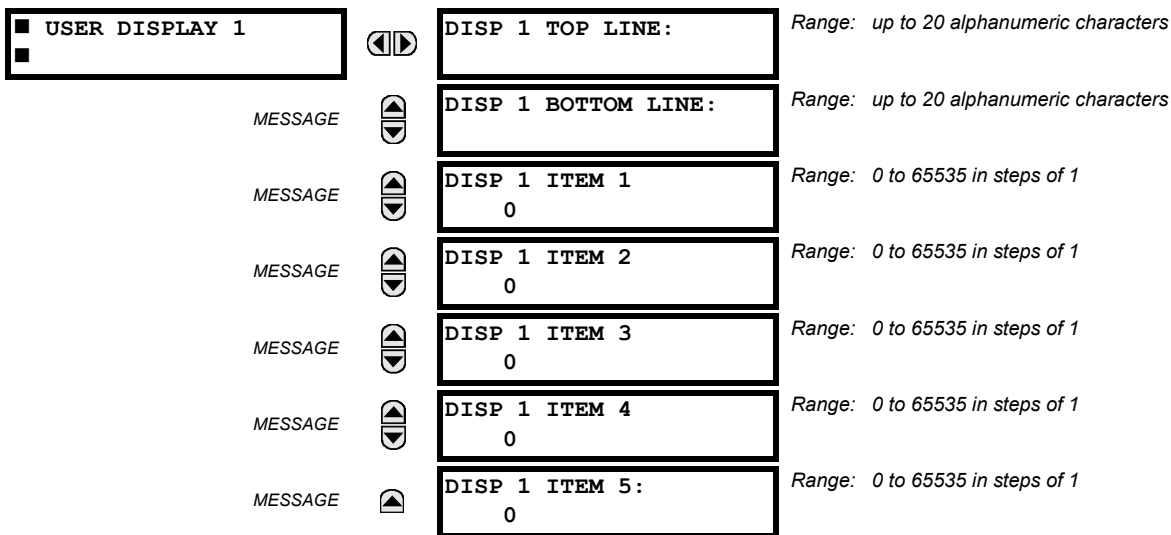

Any existing system display can be automatically copied into an available user display by selecting the existing display and pressing the **ENTER** key. The display will then prompt **ADD TO USER DISPLAY LIST?**. After selecting “Yes”, a message indicates that the selected display has been added to the user display list. When this type of entry occurs, the sub-menus are automatically configured with the proper content – this content may subsequently be edited.

This menu is used to enter user-defined text and/or user-selected Modbus-registered data fields into the particular user display. Each user display consists of two 20-character lines (top and bottom). The tilde (~) character is used to mark the start of a data field - the length of the data field needs to be accounted for. Up to 5 separate data fields (**ITEM 1(5)**) can be entered in a user display - the *n*th tilde (~) refers to the *n*th item.

A User Display may be entered from the faceplate keypad or the enerVista UR Setup interface (preferred for convenience). The following procedure shows how to enter text characters in the top and bottom lines from the faceplate keypad:

1. Select the line to be edited.
2. Press the **▲** key to enter text edit mode.
3. Use either Value key to scroll through the characters. A space is selected like a character.
4. Press the **▲** key to advance the cursor to the next position.
5. Repeat step 3 and continue entering characters until the desired text is displayed.
6. The **HELP** key may be pressed at any time for context sensitive help information.
7. Press the **ENTER** key to store the new settings.

To enter a numerical value for any of the 5 items (the *decimal form* of the selected Modbus address) from the faceplate keypad, use the number keypad. Use the value of '0' for any items not being used. Use the **HELP** key at any selected system display (setting, actual value, or command) which has a Modbus address, to view the *hexadecimal form* of the Modbus address, then manually convert it to decimal form before entering it (enerVista UR Setup usage conveniently facilitates this conversion).

Use the **MENU** key to go to the user displays menu to view the user-defined content. The current user displays will show in sequence, changing every 4 seconds. While viewing a user display, press the **ENTER** key and then select the “Yes” option to remove the display from the user display list. Use the **MENU** key again to exit the user displays menu.

An example User Display setup and result is shown below:

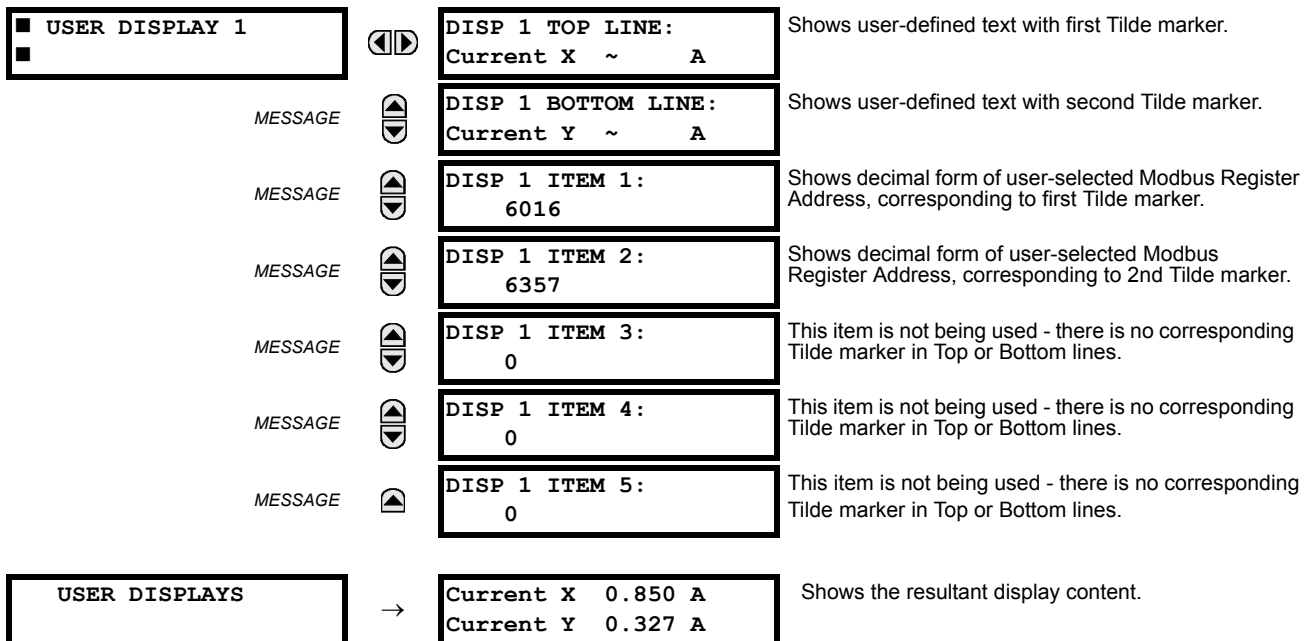

5.2.17 DIRECT INPUTS/OUTPUTS

a) MAIN MENU

PATH: SETTINGS ⇒ PRODUCT SETUP ⇨ DIRECT I/O

■ DIRECT I/O	◀▶	DIRECT OUTPUT DEVICE ID: 1	Range: 1 to 16
MESSAGE	▲▼	DIRECT I/O CH1 RING CONFIGURATION: Yes	Range: Yes, No
MESSAGE	▲▼	DIRECT I/O CH2 RING CONFIGURATION: Yes	Range: Yes, No
MESSAGE	▲▼	DIRECT I/O DATA RATE: 64 kbps	Range: 64 kbps, 128 kbps
MESSAGE	▲▼	DIRECT I/O CHANNEL CROSSOVER: Disabled	Range: Disabled, Enabled
MESSAGE	▲▼	■ CRC ALARM CH1 ■	See page 5-40.
MESSAGE	▲▼	■ CRC ALARM CH2 ■	See page 5-40.
MESSAGE	▲▼	■ UNRETURNED ■ MESSAGES ALARM CH1	See page 5-41.
MESSAGE	▲	■ UNRETURNED ■ MESSAGES ALARM CH2	See page 5-41.

Direct inputs/outputs are intended for exchange of status information (inputs and outputs) between UR-series relays connected directly via Type-7 digital communications cards. The mechanism is very similar to IEC 61850 GSSE, except that communications takes place over a non-switchable isolated network and is optimized for speed. On Type 7 cards that support two channels, direct output messages are sent from both channels simultaneously. This effectively sends direct output messages both ways around a ring configuration. On Type 7 cards that support one channel, direct output messages are sent only in one direction. Messages will be resent (forwarded) when it is determined that the message did not originate at the receiver.

Direct output message timing is similar to GSSE message timing. Integrity messages (with no state changes) are sent at least every 1000 ms. Messages with state changes are sent within the main pass scanning the inputs and asserting the outputs unless the communication channel bandwidth has been exceeded. Two Self-Tests are performed and signaled by the following FlexLogic™ operands:

1. DIRECT RING BREAK (direct input/output ring break). This FlexLogic™ operand indicates that direct output messages sent from a UR-series relay are not being received back by the relay.
2. DIRECT DEVICE 1(16) OFF (direct device offline). This FlexLogic™ operand indicates that direct output messages from at least one direct device are not being received.

Direct input/output settings are similar to remote input/output settings. The equivalent of the remote device name strings for direct inputs/outputs is the **DIRECT OUTPUT DEVICE ID**. The **DIRECT OUTPUT DEVICE ID** identifies the relay in all direct output messages. All UR-series IEDs in a ring should have unique numbers assigned. The IED ID is used to identify the sender of the direct input/output message.

If the direct input/output scheme is configured to operate in a ring (**DIRECT I/O RING CONFIGURATION**: "Yes"), all direct output messages should be received back. If not, the Direct Input/Output Ring Break self-test is triggered. The self-test error is signaled by the DIRECT RING BREAK FlexLogic™ operand.

Select the **DIRECT I/O DATA RATE** to match the data capabilities of the communications channel. Back-to-back connections of the local relays configured with the 7A, 7B, 7C, 7D, 7H, 7I, 7J, 7K, 72 and 73 fiber optic communication cards may be set to 128 kbps. For local relays configured with all other communication cards (i.e. 7E, 7F, 7G, 7L, 7M, 7N, 7P, 7R, 7S, 7T, 7W, 74, 75, 76 and 77), the baud rate will be set to 64 kbps. All IEDs communicating over direct inputs/outputs must be set to

the same data rate. UR-series IEDs equipped with dual-channel communications cards apply the same data rate to both channels. Delivery time for direct input/output messages is approximately 0.2 of a power system cycle at 128 kbps and 0.4 of a power system cycle at 64 kbps, per each 'bridge'.



The G.703 and RS422 modules are fixed at 64 kbps only. The SETTINGS ⇒ PRODUCT SETUP ⇒ DIRECT I/O ⇒ DIRECT I/O DATA RATE setting is not applicable to these modules.

The **DIRECT I/O CHANNEL CROSSOVER** setting applies to F35s with dual-channel communication cards and allows crossing over messages from Channel 1 to Channel 2. This places all UR-series IEDs into one direct input/output network regardless of the physical media of the two communication channels.

The following application examples illustrate the basic concepts for direct input/output configuration. Please refer to the *Inputs/Outputs* section in this chapter for information on configuring FlexLogic™ operands (flags, bits) to be exchanged.

EXAMPLE 1: EXTENDING THE INPUT/OUTPUT CAPABILITIES OF A UR-SERIES RELAY

Consider an application that requires additional quantities of digital inputs and/or output contacts and/or lines of programmable logic that exceed the capabilities of a single UR-series chassis. The problem is solved by adding an extra UR-series IED, such as the C30, to satisfy the additional input/output and programmable logic requirements. The two IEDs are connected via single-channel digital communication cards as shown in the figure below.

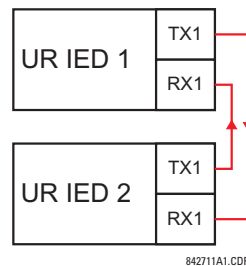

Figure 5–7: INPUT/OUTPUT EXTENSION VIA DIRECT I/Os

In the above application, the following settings should be applied:

UR IED 1: **DIRECT OUTPUT DEVICE ID:** "1"
DIRECT I/O RING CONFIGURATION: "Yes"
DIRECT I/O DATA RATE: "128 kbps"

UR IED 2: **DIRECT OUTPUT DEVICE ID:** "2"
DIRECT I/O RING CONFIGURATION: "Yes"
DIRECT I/O DATA RATE: "128 kbps"

The message delivery time is about 0.2 of power cycle in both ways (at 128 kbps); i.e., from Device 1 to Device 2, and from Device 2 to Device 1. Different communications cards can be selected by the user for this back-to-back connection (fiber, G.703, or RS422).

EXAMPLE 2: INTERLOCKING BUSBAR PROTECTION

A simple interlocking busbar protection scheme could be accomplished by sending a blocking signal from downstream devices, say 2, 3, and 4, to the upstream device that monitors a single incomer of the busbar, as shown below.

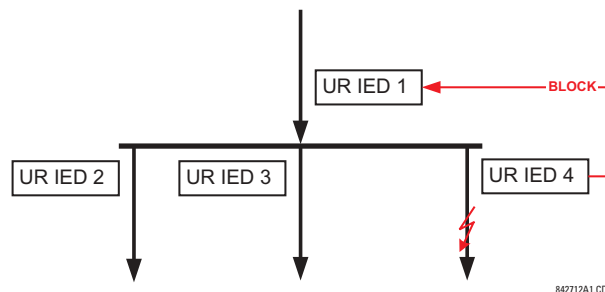

Figure 5–8: SAMPLE INTERLOCKING BUSBAR PROTECTION SCHEME

For increased reliability, a dual-ring configuration (shown below) is recommended for this application.

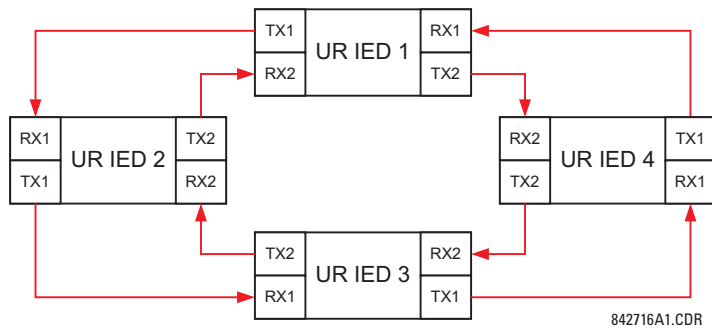

Figure 5-9: INTERLOCKING BUS PROTECTION SCHEME VIA DIRECT I/O

In the above application, the following settings should be applied:

UR IED 1:	DIRECT OUTPUT DEVICE ID: "1"	UR IED 2:	DIRECT OUTPUT DEVICE ID: "2"
	DIRECT I/O RING CONFIGURATION: "Yes"		DIRECT I/O RING CONFIGURATION: "Yes"
UR IED 3:	DIRECT OUTPUT DEVICE ID: "3"	UR IED 4:	DIRECT OUTPUT DEVICE ID: "4"
	DIRECT I/O RING CONFIGURATION: "Yes"		DIRECT I/O RING CONFIGURATION: "Yes"

Message delivery time is approximately 0.2 of power system cycle (at 128 kbps) times number of 'bridges' between the origin and destination. Dual-ring configuration effectively reduces the maximum 'communications distance' by a factor of two.

In this configuration the following delivery times are expected (at 128 kbps) if both rings are healthy:

IED 1 to IED 2: 0.2 of power system cycle; IED 1 to IED 3: 0.4 of power system cycle;
 IED 1 to IED 4: 0.2 of power system cycle; IED 2 to IED 3: 0.2 of power system cycle;
 IED 2 to IED 4: 0.4 of power system cycle; IED 3 to IED 4: 0.2 of power system cycle

If one ring is broken (say TX2/RX2) the delivery times are as follows:

IED 1 to IED 2: 0.2 of power system cycle; IED 1 to IED 3: 0.4 of power system cycle;
 IED 1 to IED 4: 0.6 of power system cycle; IED 2 to IED 3: 0.2 of power system cycle;
 IED 2 to IED 4: 0.4 of power system cycle; IED 3 to IED 4: 0.2 of power system cycle

A coordinating timer for this bus protection scheme could be selected to cover the worst case scenario (0.4 of power system cycle). Upon detecting a broken ring, the coordination time should be adaptively increased to 0.6 of power system cycle. The complete application requires addressing a number of issues such as failure of both the communications rings, failure or out-of-service conditions of one of the relays, etc. Self-monitoring flags of the direct inputs/outputs feature would be primarily used to address these concerns.

EXAMPLE 3: PILOT-AIDED SCHEMES

Consider the three-terminal line protection application shown below:

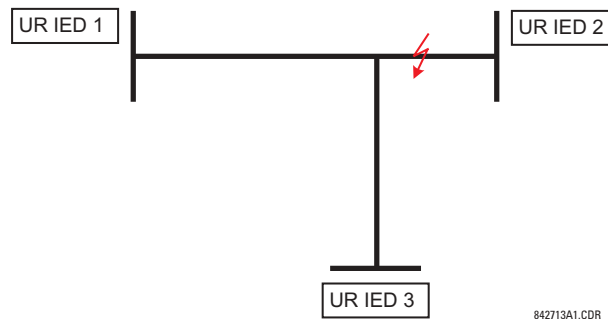

Figure 5-10: THREE-TERMINAL LINE APPLICATION

A permissive pilot-aided scheme could be implemented in a two-ring configuration as shown below (IEDs 1 and 2 constitute a first ring, while IEDs 2 and 3 constitute a second ring):

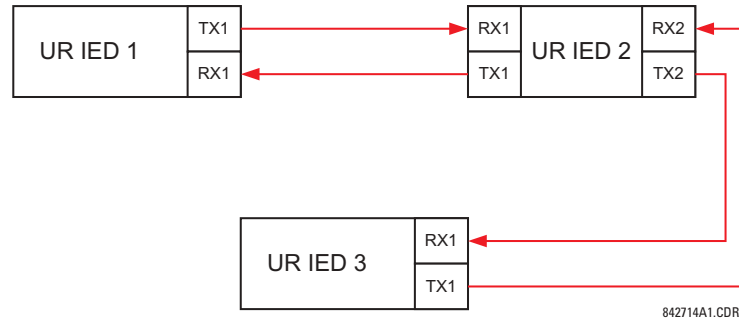

Figure 5-11: SINGLE-CHANNEL OPEN LOOP CONFIGURATION

In the above application, the following settings should be applied:

- | | | | |
|-----------|---|-----------|---|
| UR IED 1: | DIRECT OUTPUT DEVICE ID: "1" | UR IED 2: | DIRECT OUTPUT DEVICE ID: "2" |
| | DIRECT I/O RING CONFIGURATION: "Yes" | | DIRECT I/O RING CONFIGURATION: "Yes" |
| UR IED 3: | DIRECT OUTPUT DEVICE ID: "3" | | |
| | DIRECT I/O RING CONFIGURATION: "Yes" | | |

In this configuration the following delivery times are expected (at 128 kbps):

- IED 1 to IED 2: 0.2 of power system cycle; IED 1 to IED 3: 0.5 of power system cycle;
- IED 2 to IED 3: 0.2 of power system cycle

In the above scheme, IEDs 1 and 3 do not communicate directly. IED 2 must be configured to forward the messages as explained in the *Inputs/Outputs* section. A blocking pilot-aided scheme should be implemented with more security and, ideally, faster message delivery time. This could be accomplished using a dual-ring configuration as shown below.

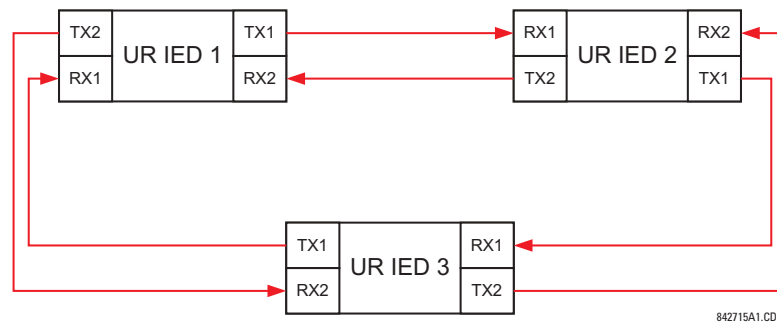

Figure 5-12: DUAL-CHANNEL CLOSED LOOP (DUAL-RING) CONFIGURATION

In the above application, the following settings should be applied:

- | | | | |
|-----------|---|-----------|---|
| UR IED 1: | DIRECT OUTPUT DEVICE ID: "1" | UR IED 2: | DIRECT OUTPUT DEVICE ID: "2" |
| | DIRECT I/O RING CONFIGURATION: "Yes" | | DIRECT I/O RING CONFIGURATION: "Yes" |
| UR IED 3: | DIRECT OUTPUT DEVICE ID: "3" | | |
| | DIRECT I/O RING CONFIGURATION: "Yes" | | |

In this configuration the following delivery times are expected (at 128 kbps) if both the rings are healthy:

- IED 1 to IED 2: 0.2 of power system cycle; IED 1 to IED 3: 0.2 of power system cycle;
- IED 2 to IED 3: 0.2 of power system cycle

The two communications configurations could be applied to both permissive and blocking schemes. Speed, reliability and cost should be taken into account when selecting the required architecture.

b) CRC ALARM CH1(2)

PATH: SETTINGS ⇒ PRODUCT SETUP ⇒ DIRECT I/O ⇒ CRC ALARM CH1(2)

■ CRC ALARM CH1	◀▶	CRC ALARM CH1 FUNCTION: Disabled	Range: Enabled, Disabled
MESSAGE	▲▼	CRC ALARM CH1 MESSAGE COUNT: 600	Range: 100 to 10000 in steps of 1
MESSAGE	▲▼	CRC ALARM CH1 THRESHOLD: 10	Range: 1 to 1000 in steps of 1
MESSAGE	▲	CRC ALARM CH1 EVENTS: Disabled	Range: Enabled, Disabled

The F35 checks integrity of the incoming direct input/output messages using a 32-bit CRC. The CRC Alarm function is available for monitoring the communication medium noise by tracking the rate of messages failing the CRC check. The monitoring function counts all incoming messages, including messages that failed the CRC check. A separate counter adds up messages that failed the CRC check. When the failed CRC counter reaches the user-defined level specified by the **CRC ALARM CH1 THRESHOLD** setting within the user-defined message count **CRC ALARM 1 CH1 COUNT**, the DIR IO CH1 CRC ALARM FlexLogic™ operand is set.

When the total message counter reaches the user-defined maximum specified by the **CRC ALARM CH1 MESSAGE COUNT** setting, both the counters reset and the monitoring process is restarted.

The operand shall be configured to drive an output contact, user-programmable LED, or selected communication-based output. Latching and acknowledging conditions - if required - should be programmed accordingly.

The CRC Alarm function is available on a per-channel basis. The total number of direct input/output messages that failed the CRC check is available as the **ACTUAL VALUES ⇒ STATUS ⇒ DIRECT INPUTS ⇒ CRC FAIL COUNT CH1(2)** actual value.

Message Count and Length of the Monitoring Window:

To monitor communications integrity, the relay sends 1 message per second (at 64 kbps) or 2 messages per second (128 kbps) even if there is no change in the direct outputs. For example, setting the **CRC ALARM CH1 MESSAGE COUNT** to “10000”, corresponds a time window of about 160 minutes at 64 kbps and 80 minutes at 128 kbps. If the messages are sent faster as a result of direct outputs activity, the monitoring time interval will shorten. This should be taken into account when determining the **CRC ALARM CH1 MESSAGE COUNT** setting. For example, if the requirement is a maximum monitoring time interval of 10 minutes at 64 kbps, then the **CRC ALARM CH1 MESSAGE COUNT** should be set to $10 \times 60 \times 1 = 600$.

Correlation of Failed CRC and Bit Error Rate (BER):

The CRC check may fail if one or more bits in a packet are corrupted. Therefore, an exact correlation between the CRC fail rate and the BER is not possible. Under certain assumptions an approximation can be made as follows. A direct input/output packet containing 20 bytes results in 160 bits of data being sent and therefore, a transmission of 63 packets is equivalent to 10,000 bits. A BER of 10^{-4} implies 1 bit error for every 10,000 bits sent/received. Assuming the best case of only 1 bit error in a failed packet, having 1 failed packet for every 63 received is about equal to a BER of 10^{-4} .

c) UNRETURNED MESSAGES ALARM CH1(2)

PATH: SETTINGS ⇒ PRODUCT SETUP ⇒ DIRECT I/O ⇒ UNRETURNED MESSAGES ALARM CH1(2)

■ UNRETURNED ■ MESSAGES ALARM CH1	◀▶	UNRET MSGS ALARM CH1 FUNCTION: Disabled	Range: Enabled, Disabled
MESSAGE	▲▼	UNRET MSGS ALARM CH1 MESSAGE COUNT: 600	Range: 100 to 10000 in steps of 1
MESSAGE	▲▼	UNRET MSGS ALARM CH1 THRESHOLD: 10	Range: 1 to 1000 in steps of 1
MESSAGE	▲	UNRET MSGS ALARM CH1 EVENTS: Disabled	Range: Enabled, Disabled

The F35 checks integrity of the direct input/output communication ring by counting unreturned messages. In the ring configuration, all messages originating at a given device should return within a pre-defined period of time. The Unreturned Messages Alarm function is available for monitoring the integrity of the communication ring by tracking the rate of unreturned messages. This function counts all the outgoing messages and a separate counter adds the messages have failed to return. When the unreturned messages counter reaches the user-definable level specified by the **UNRET MSGS ALARM CH1 THRESHOLD** setting and within the user-defined message count **UNRET MSGS ALARM CH1 COUNT**, the DIR IO CH1 UNRET ALM FlexLogic™ operand is set.

When the total message counter reaches the user-defined maximum specified by the **UNRET MSGS ALARM CH1 MESSAGE COUNT** setting, both the counters reset and the monitoring process is restarted.

The operand shall be configured to drive an output contact, user-programmable LED, or selected communication-based output. Latching and acknowledging conditions, if required, should be programmed accordingly.

The Unreturned Messages Alarm function is available on a per-channel basis and is active only in the ring configuration. The total number of unreturned input/output messages is available as the **ACTUAL VALUES ⇒ STATUS ⇒ DIRECT INPUTS ⇒ UNRETURNED MSG COUNT CH1(2)** actual value.

5

5.2.18 INSTALLATION

PATH: SETTINGS ⇒ PRODUCT SETUP ⇒ INSTALLATION

■ INSTALLATION	◀▶	RELAY SETTINGS: Not Programmed	Range: Not Programmed, Programmed
MESSAGE	▲	RELAY NAME: Relay-1	Range: up to 20 alphanumeric characters

To safeguard against the installation of a relay without any entered settings, the unit will not allow signaling of any output relay until **RELAY SETTINGS** is set to "Programmed". This setting is defaulted to "Not Programmed" when at the factory. The **UNIT NOT PROGRAMMED** self-test error message is displayed until the relay is put into the "Programmed" state.

The **RELAY NAME** setting allows the user to uniquely identify a relay. This name will appear on generated reports. This name is also used to identify specific devices which are engaged in automatically sending/receiving data over the Ethernet communications channel using the IEC 61850 protocol.

5.3.1 AC INPUTS

a) CURRENT BANKS

PATH: SETTINGS ⇌ SYSTEM SETUP ⇌ AC INPUTS ⇌ CURRENT BANK F1(U5)

■ CURRENT BANK F1	◀▶	PHASE CT F1 PRIMARY: 1 A	Range: 1 to 65000 A in steps of 1
MESSAGE	▲▼	PHASE CT F1 SECONDARY: 1 A	Range: 1 A, 5 A
MESSAGE	▲▼	GROUND CT F1 PRIMARY: 1 A	Range: 1 to 65000 A in steps of 1
MESSAGE	▲	GROUND CT F1 SECONDARY: 1 A	Range: 1 A, 5 A



Because energy parameters are accumulated, these values should be recorded and then reset immediately prior to changing CT characteristics.

Six banks of phase/ground CTs can be set, where the current banks are denoted in the following format (X represents the module slot position letter):

Xa , where $X = \{F, M, U\}$ and $a = \{1, 5\}$.

See the *Introduction to AC Sources* section at the beginning of this chapter for additional details.

These settings are critical for all features that have settings dependent on current measurements. When the relay is ordered, the CT module must be specified to include a standard or sensitive ground input. As the phase CTs are connected in Wye (star), the calculated phasor sum of the three phase currents ($I_A + I_B + I_C = \text{Neutral Current} = 3I_o$) is used as the input for the neutral overcurrent elements. In addition, a zero-sequence (core balance) CT which senses current in all of the circuit primary conductors, or a CT in a neutral grounding conductor may also be used. For this configuration, the ground CT primary rating must be entered. To detect low level ground fault currents, the sensitive ground input may be used. In this case, the sensitive ground CT primary rating must be entered. Refer to Chapter 3 for more details on CT connections.

Enter the rated CT primary current values. For both 1000:5 and 1000:1 CTs, the entry would be 1000. For correct operation, the CT secondary rating must match the setting (which must also correspond to the specific CT connections used).

The following example illustrates how multiple CT inputs (current banks) are summed as one source current. Given If the following current banks:

F1: CT bank with 500:1 ratio; F5: CT bank with 1000: ratio; M1: CT bank with 800:1 ratio

The following rule applies:

$$\text{SRC 1} = F1 + F5 + M1 \quad (\text{EQ 5.5})$$

1 pu is the highest primary current. In this case, 1000 is entered and the secondary current from the 500:1 ratio CT will be adjusted to that created by a 1000:1 CT before summation. If a protection element is set up to act on SRC 1 currents, then a pickup level of 1 pu will operate on 1000 A primary.

The same rule applies for current sums from CTs with different secondary taps (5 A and 1 A).

b) VOLTAGE BANKS

PATH: SETTINGS ⇒ SYSTEM SETUP ⇒ AC INPUTS ⇒ VOLTAGE BANK F5(U5)

<input checked="" type="checkbox"/> VOLTAGE BANK F5	◀▶	PHASE VT F5 CONNECTION: Wye	Range: Wye, Delta
MESSAGE	▲▼	PHASE VT F5 SECONDARY: 66.4 V	Range: 50.0 to 240.0 V in steps of 0.1
MESSAGE	▲▼	PHASE VT F5 RATIO: 1.00 :1	Range: 1.00 to 24000.00 in steps of 0.01
MESSAGE	▲▼	AUXILIARY VT F5 CONNECTION: Vag	Range: Vn, Vag, Vbg, Vcg, Vab, Vbc, Vca
MESSAGE	▲▼	AUXILIARY VT F5 SECONDARY: 66.4 V	Range: 50.0 to 240.0 V in steps of 0.1
MESSAGE	▲	AUXILIARY VT F5 RATIO: 1.00 :1	Range: 1.00 to 24000.00 in steps of 0.01



Because energy parameters are accumulated, these values should be recorded and then reset immediately prior to changing VT characteristics.

Three banks of phase/auxiliary VTs can be set, where voltage banks are denoted in the following format (X represents the module slot position letter):

Xa, where **X** = {F, M, U} and **a** = {5}.

See the *Introduction to AC Sources* section at the beginning of this chapter for additional details.

With VTs installed, the relay can perform voltage measurements as well as power calculations. Enter the **PHASE VT F5 CONNECTION** made to the system as “Wye” or “Delta”. An open-delta source VT connection would be entered as “Delta”. See the *Typical Wiring Diagram* in Chapter 3 for details.



The nominal **PHASE VT F5 SECONDARY** voltage setting is the voltage across the relay input terminals when nominal voltage is applied to the VT primary.

For example, on a system with a 13.8 kV nominal primary voltage and with a 14400:120 volt VT in a Delta connection, the secondary voltage would be 115, i.e. $(13800 / 14400) \times 120$. For a Wye connection, the voltage value entered must be the phase to neutral voltage which would be $115 / \sqrt{3} = 66.4$.

On a 14.4 kV system with a Delta connection and a VT primary to secondary turns ratio of 14400:120, the voltage value entered would be 120, i.e. $14400 / 120$.

5.3.2 POWER SYSTEM

PATH: SETTINGS ⇒ SYSTEM SETUP ⇒ POWER SYSTEM

<input checked="" type="checkbox"/> POWER SYSTEM	◀▶	NOMINAL FREQUENCY: 60 Hz	Range: 25 to 60 Hz in steps of 1
MESSAGE	▲▼	PHASE ROTATION: ABC	Range: ABC, ACB
MESSAGE	▲▼	FREQUENCY AND PHASE REFERENCE: SRC 1	Range: SRC 1, SRC 2, SRC 3, SRC 4, SRC 5, SRC 6
MESSAGE	▲	FREQUENCY TRACKING: Enabled	Range: Disabled, Enabled

The power system **NOMINAL FREQUENCY** value is used as a default to set the digital sampling rate if the system frequency cannot be measured from available signals. This may happen if the signals are not present or are heavily distorted. Before reverting to the nominal frequency, the frequency tracking algorithm holds the last valid frequency measurement for a safe period of time while waiting for the signals to reappear or for the distortions to decay.

The phase sequence of the power system is required to properly calculate sequence components and power parameters. The **PHASE ROTATION** setting matches the power system phase sequence. Note that this setting informs the relay of the actual system phase sequence, either ABC or ACB. CT and VT inputs on the relay, labeled as A, B, and C, must be connected to system phases A, B, and C for correct operation.

The **FREQUENCY AND PHASE REFERENCE** setting determines which signal source is used (and hence which AC signal) for phase angle reference. The AC signal used is prioritized based on the AC inputs that are configured for the signal source: phase voltages takes precedence, followed by auxiliary voltage, then phase currents, and finally ground current.

For three phase selection, phase A is used for angle referencing ($V_{\text{ANGLE REF}} = V_A$), while Clarke transformation of the phase signals is used for frequency metering and tracking ($V_{\text{FREQUENCY}} = (2V_A - V_B - V_C)/3$) for better performance during fault, open pole, and VT and CT fail conditions.

The phase reference and frequency tracking AC signals are selected based upon the Source configuration, regardless of whether or not a particular signal is actually applied to the relay.

Phase angle of the reference signal will always display zero degrees and all other phase angles will be relative to this signal. If the pre-selected reference signal is not measurable at a given time, the phase angles are not referenced.

The phase angle referencing is done via a phase locked loop, which can synchronize independent UR-series relays if they have the same AC signal reference. These results in very precise correlation of time tagging in the event recorder between different UR-series relays provided the relays have an IRIG-B connection.



FREQUENCY TRACKING should only be set to "Disabled" in very unusual circumstances; consult the factory for special variable-frequency applications.

5.3.3 SIGNAL SOURCES

5

PATH: SETTINGS ⇄ SYSTEM SETUP ⇄ SIGNAL SOURCES ⇄ SOURCE 1(6)

SOURCE 1	◀▶	SOURCE 1 NAME: SRC 1	Range: up to 6 alphanumeric characters
MESSAGE	▲▼	SOURCE 1 PHASE CT: None	Range: None, F1, F5, F1+F5,... up to a combination of any 5 CTs. Only Phase CT inputs are displayed.
MESSAGE	▲▼	SOURCE 1 GROUND CT: None	Range: None, F1, F5, F1+F5,... up to a combination of any 5 CTs. Only Ground CT inputs are displayed.
MESSAGE	▲▼	SOURCE 1 PHASE VT: None	Range: None, F1, F5, M1, M5, U1, U5 Only phase voltage inputs will be displayed.
MESSAGE	▲	SOURCE 1 AUX VT: None	Range: None, F1, F5, M1, M5, U1, U5 Only auxiliary voltage inputs will be displayed.

Six identical source menus are available. The "SRC 1" text can be replaced by with a user-defined name appropriate for the associated source.

"F", "M", and "U" represent the module slot position. The number directly following these letters represents either the first bank of four channels (1, 2, 3, 4) called "1" or the second bank of four channels (5, 6, 7, 8) called "5" in a particular CT/VT module. Refer to the Introduction to AC Sources section at the beginning of this chapter for additional details on this concept.

It is possible to select the sum of up to five (5) CTs. The first channel displayed is the CT to which all others will be referred. For example, the selection "F1+F5" indicates the sum of each phase from channels "F1" and "F5", scaled to whichever CT has the higher ratio. Selecting "None" hides the associated actual values.

The approach used to configure the AC sources consists of several steps; first step is to specify the information about each CT and VT input. For CT inputs, this is the nominal primary and secondary current. For VTs, this is the connection type, ratio and nominal secondary voltage. Once the inputs have been specified, the configuration for each Source is entered, including specifying which CTs will be summed together.

User Selection of AC Parameters for Comparator Elements:

CT/VT modules automatically calculate all current and voltage parameters from the available inputs. Users must select the specific input parameters to be measured by every element in the relevant settings menu. The internal design of the element specifies which type of parameter to use and provides a setting for Source selection. In elements where the parameter may be either fundamental or RMS magnitude, such as phase time overcurrent, two settings are provided. One setting specifies the Source, the second setting selects between fundamental phasor and RMS.

AC Input Actual Values:

The calculated parameters associated with the configured voltage and current inputs are displayed in the current and voltage sections of actual values. Only the phasor quantities associated with the actual AC physical input channels will be displayed here. All parameters contained within a configured source are displayed in the sources section of the actual values.

EXAMPLE USE OF SOURCES:

An example of the use of sources, with a relay with CT/VT modules, is shown in the diagram below. A relay could have the following hardware configuration:

INCREASING SLOT POSITION LETTER -->		
CT/VT MODULE 1	CT/VT MODULE 2	CT/VT MODULE 3
CTs	CTs	VTs

This configuration could be used on a two winding transformer, with one winding connected into a breaker-and-a-half system. The following figure shows the arrangement of sources used to provide the functions required in this application, and the CT/VT inputs that are used to provide the data.

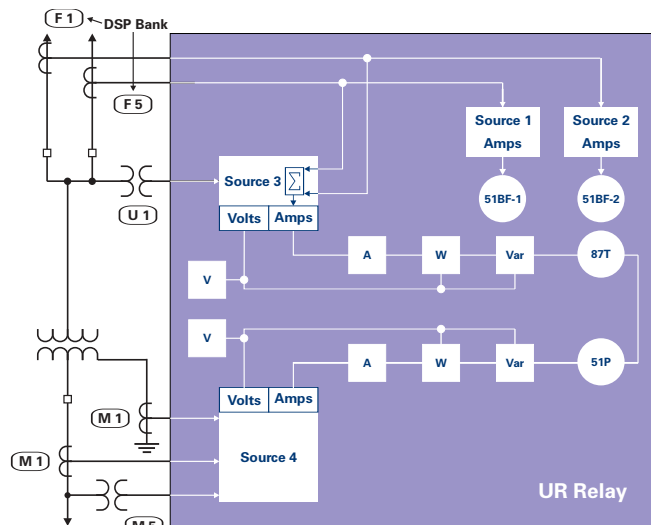

Figure 5-13: EXAMPLE USE OF SOURCES

5.3.4 FLEXCURVES™

a) SETTINGS

PATH: SETTINGS ⇨ SYSTEM SETUP ⇨ FLEXCURVES ⇨ FLEXCURVE A(D)

 FLEXCURVE A

 FLEXCURVE A TIME AT
 0.00 xPKP: 0 ms

Range: 0 to 65535 ms in steps of 1

FlexCurves™ A through D have settings for entering times to Reset/Operate at the following pickup levels: 0.00 to 0.98 / 1.03 to 20.00. This data is converted into 2 continuous curves by linear interpolation between data points. To enter a custom FlexCurve™, enter the Reset/Operate time (using the ▲ VALUE ▼ keys) for each selected pickup point (using the ▲ MESSAGE ▼ keys) for the desired protection curve (A, B, C, or D).

Table 5–3: FLEXCURVE™ TABLE

RESET	TIME MS	RESET	TIME MS	OPERATE	TIME MS	OPERATE	TIME MS	OPERATE	TIME MS	OPERATE	TIME MS
0.00		0.68		1.03		2.9		4.9		10.5	
0.05		0.70		1.05		3.0		5.0		11.0	
0.10		0.72		1.1		3.1		5.1		11.5	
0.15		0.74		1.2		3.2		5.2		12.0	
0.20		0.76		1.3		3.3		5.3		12.5	
0.25		0.78		1.4		3.4		5.4		13.0	
0.30		0.80		1.5		3.5		5.5		13.5	
0.35		0.82		1.6		3.6		5.6		14.0	
0.40		0.84		1.7		3.7		5.7		14.5	
0.45		0.86		1.8		3.8		5.8		15.0	
0.48		0.88		1.9		3.9		5.9		15.5	
0.50		0.90		2.0		4.0		6.0		16.0	
0.52		0.91		2.1		4.1		6.5		16.5	
0.54		0.92		2.2		4.2		7.0		17.0	
0.56		0.93		2.3		4.3		7.5		17.5	
0.58		0.94		2.4		4.4		8.0		18.0	
0.60		0.95		2.5		4.5		8.5		18.5	
0.62		0.96		2.6		4.6		9.0		19.0	
0.64		0.97		2.7		4.7		9.5		19.5	
0.66		0.98		2.8		4.8		10.0		20.0	



The relay using a given FlexCurve™ applies linear approximation for times between the user-entered points. Special care must be applied when setting the two points that are close to the multiple of pickup of 1, i.e. 0.98 pu and 1.03 pu. It is recommended to set the two times to a similar value; otherwise, the linear approximation may result in undesired behavior for the operating quantity that is close to 1.00 pu.

b) FLEXCURVE™ CONFIGURATION WITH ENERVISTA UR SETUP

The enerVista UR Setup software allows for easy configuration and management of FlexCurves™ and their associated data points. Prospective FlexCurves™ can be configured from a selection of standard curves to provide the best approximate fit, then specific data points can be edited afterwards. Alternately, curve data can be imported from a specified file (.csv format) by selecting the **Import Data From** enerVista UR Setup setting.

Curves and data can be exported, viewed, and cleared by clicking the appropriate buttons. FlexCurves™ are customized by editing the operating time (ms) values at pre-defined per-unit current multiples. Note that the pickup multiples start at zero (implying the "reset time"), operating time below pickup, and operating time above pickup.

c) RECLOSER CURVE EDITING

Recloser Curve selection is special in that recloser curves can be shaped into a composite curve with a minimum response time and a fixed time above a specified pickup multiples. There are 41 recloser curve types supported. These definite operating times are useful to coordinate operating times, typically at higher currents and where upstream and downstream protective devices have different operating characteristics. The Recloser Curve configuration window shown below appears when the Initialize From enerVista UR Setup setting is set to "Recloser Curve" and the Initialize FlexCurve button is clicked.

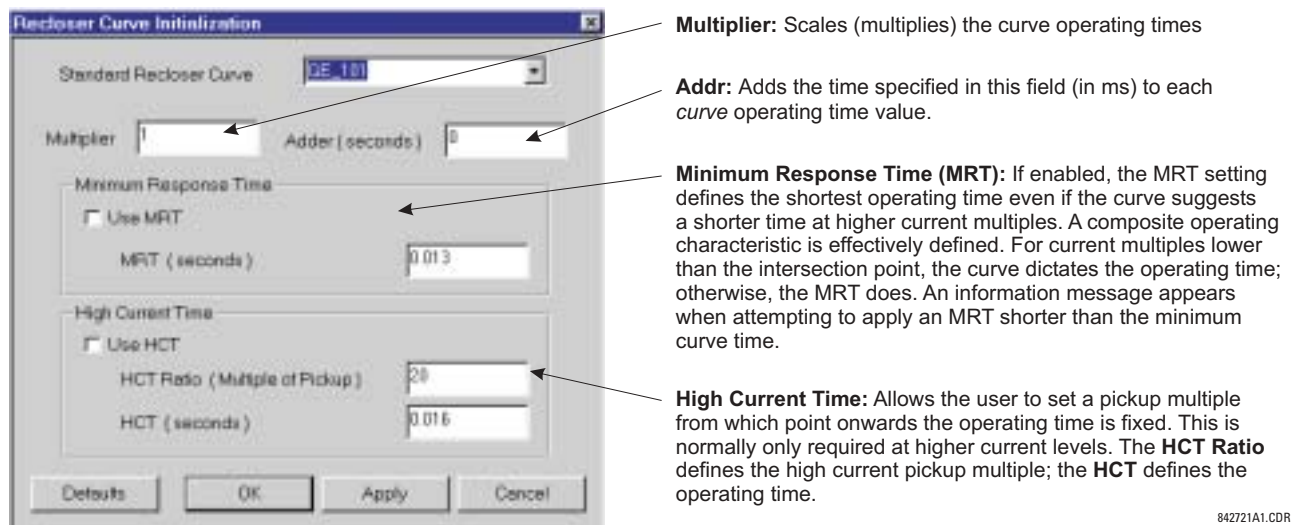

Figure 5–14: RECLOSER CURVE INITIALIZATION



NOTE

Multiplier and Adder settings only affect the curve portion of the characteristic and not the MRT and HCT settings. The HCT settings override the MRT settings for multiples of pickup greater than the HCT Ratio.

d) EXAMPLE

A composite curve can be created from the GE_111 standard with MRT = 200 ms and HCT initially disabled and then enabled at 8 times pickup with an operating time of 30 ms. At approximately 4 times pickup, the curve operating time is equal to the MRT and from then onwards the operating time remains at 200 ms (see below).

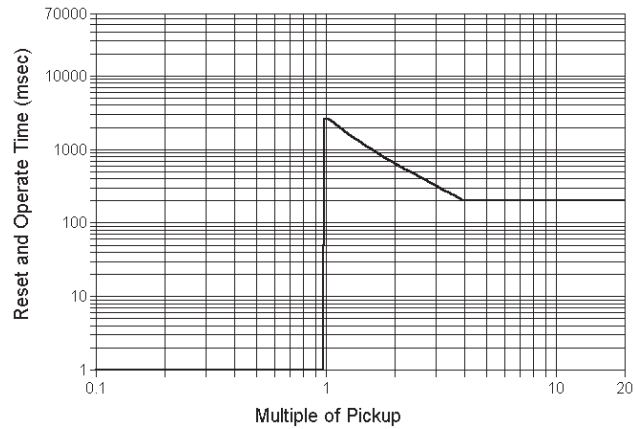

842719A1.CDR

Figure 5–15: COMPOSITE RECLOSER CURVE WITH HCT DISABLED

With the HCT feature enabled, the operating time reduces to 30 ms for pickup multiples exceeding 8 times pickup.

5

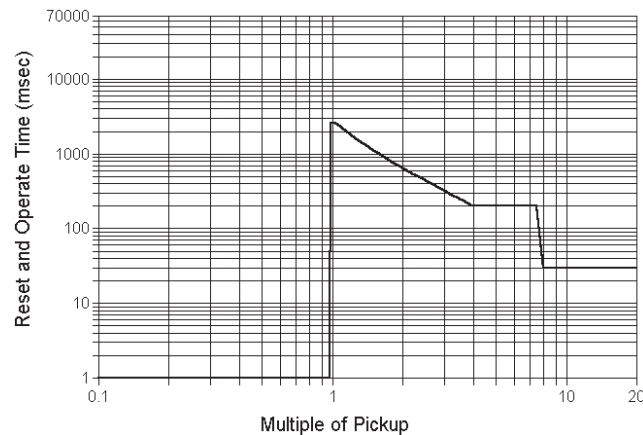

842720A1.CDR

Figure 5–16: COMPOSITE RECLOSER CURVE WITH HCT ENABLED



Configuring a composite curve with an increase in operating time at increased pickup multiples is not allowed. If this is attempted, the enerVista UR Setup software generates an error message and discards the proposed changes.

e) STANDARD RECLOSER CURVES

The standard Recloser curves available for the F35 are displayed in the following graphs.

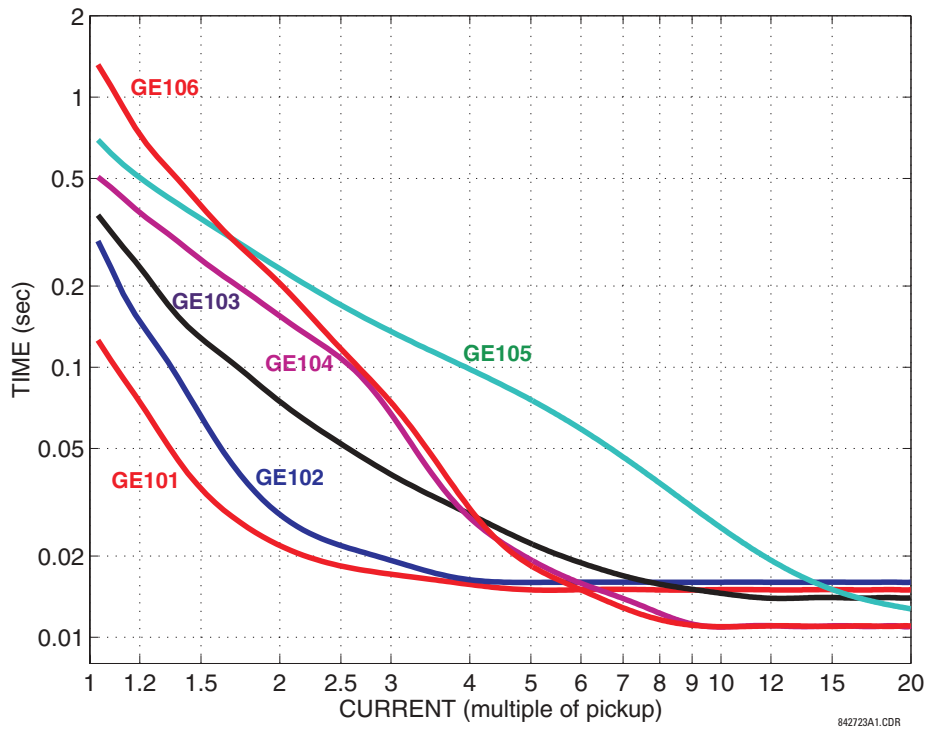

Figure 5-17: RECLOSER CURVES GE101 TO GE106

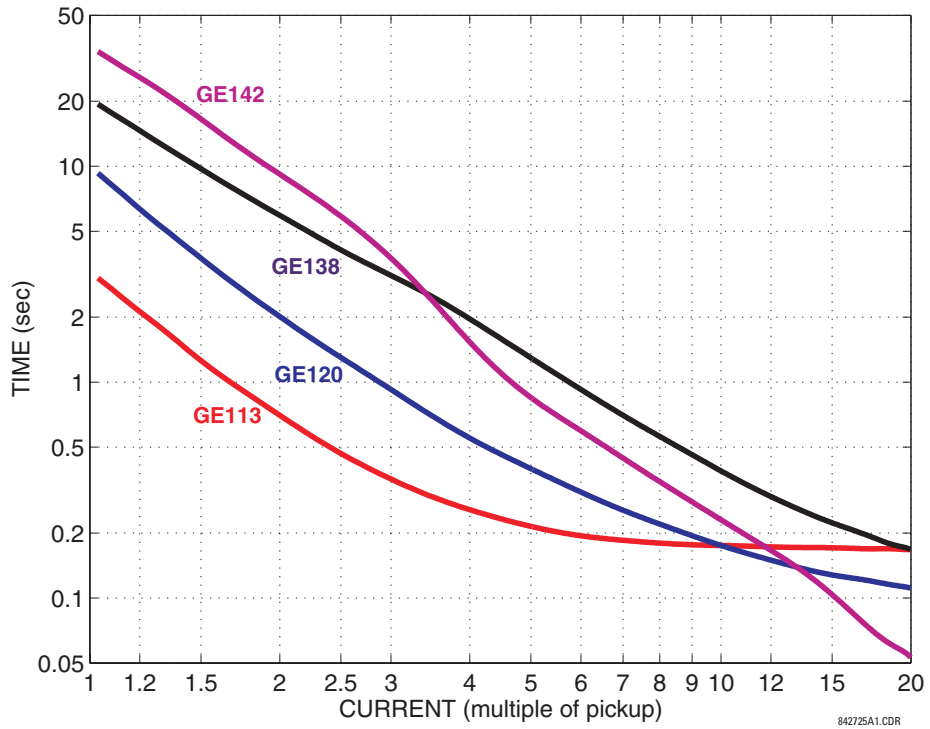

Figure 5-18: RECLOSER CURVES GE113, GE120, GE138 AND GE142

5

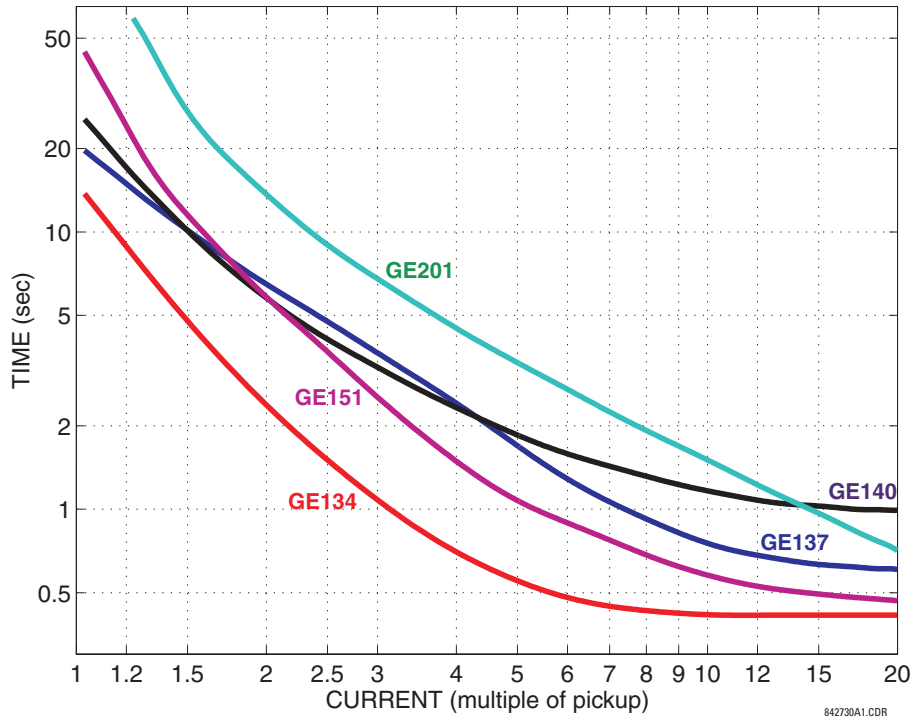

Figure 5-19: RECLOSER CURVES GE134, GE137, GE140, GE151 AND GE201

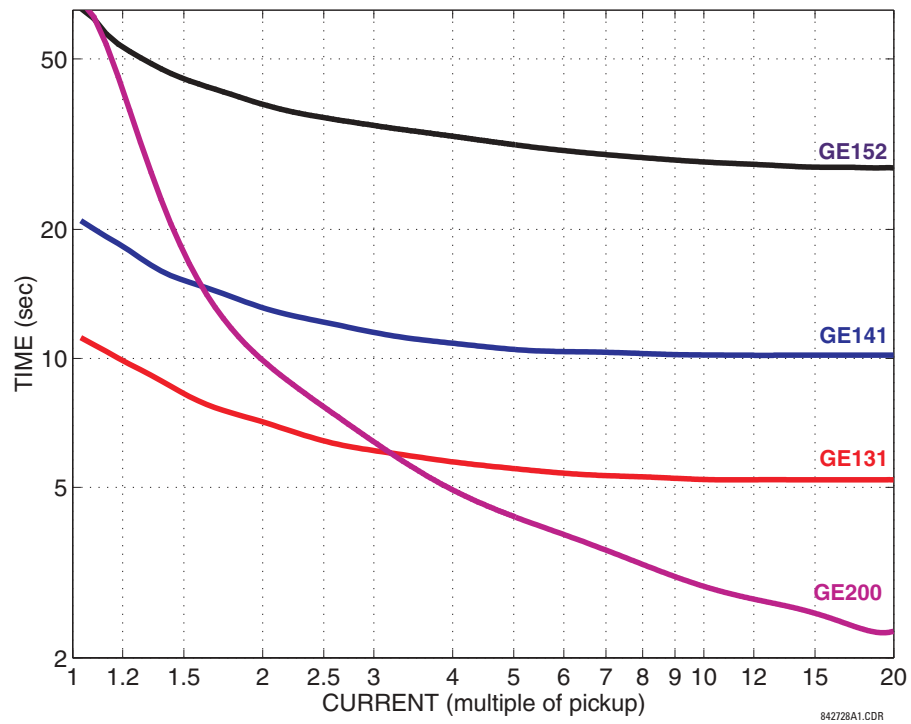

Figure 5-20: RECLOSER CURVES GE131, GE141, GE152, AND GE200

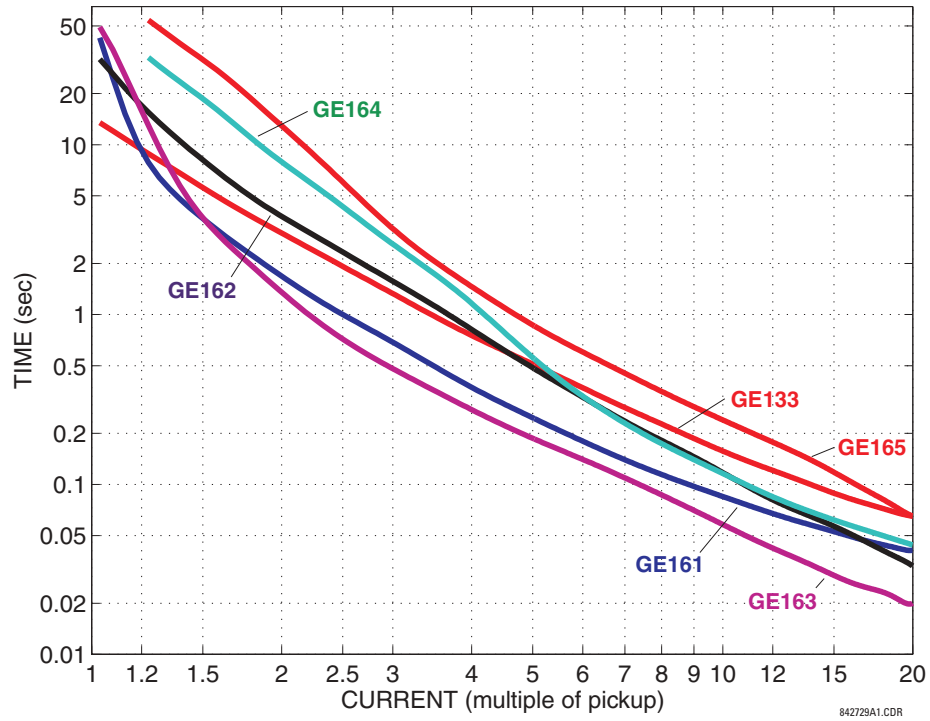

Figure 5-21: RECLOSER CURVES GE133, GE161, GE162, GE163, GE164 AND GE165

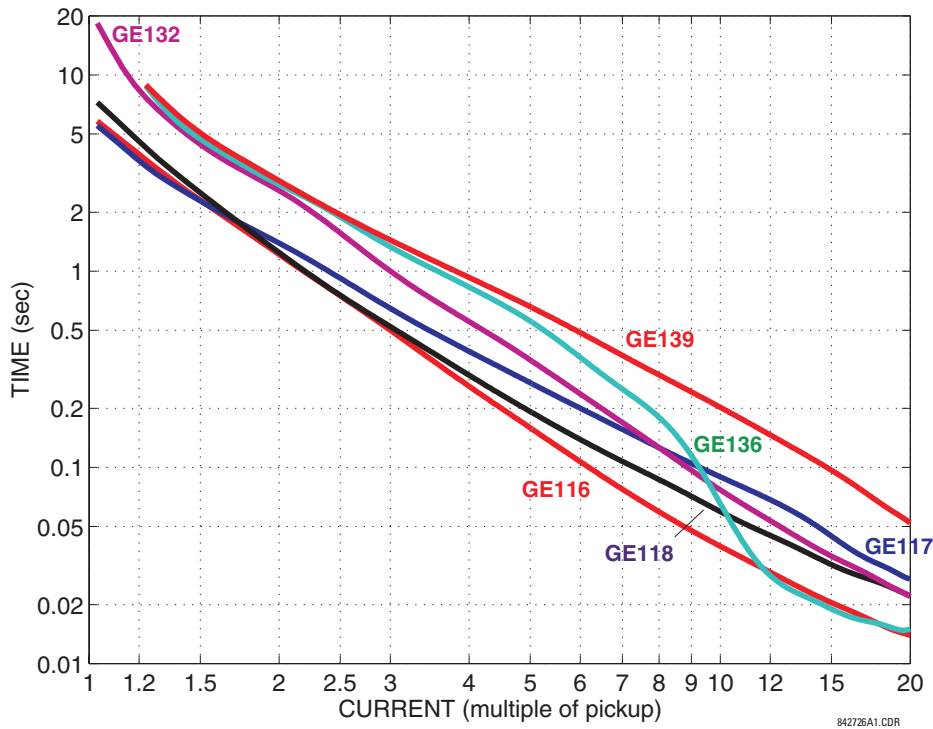

Figure 5-22: RECLOSER CURVES GE116, GE117, GE118, GE132, GE136, AND GE139

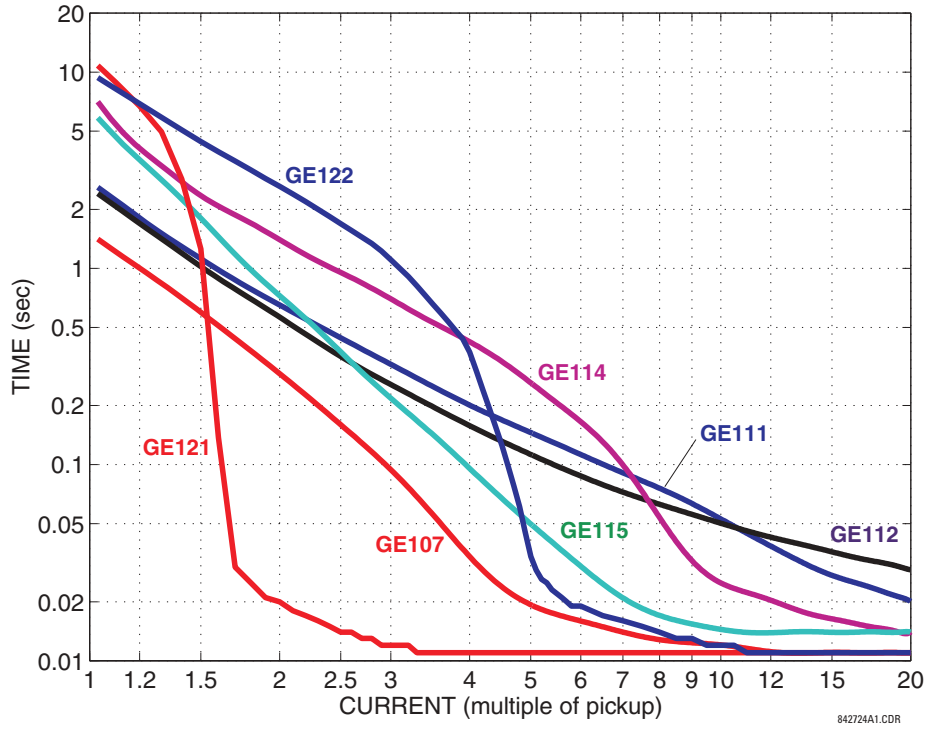

Figure 5-23: RECLOSER CURVES GE107, GE111, GE112, GE114, GE115, GE121, AND GE122

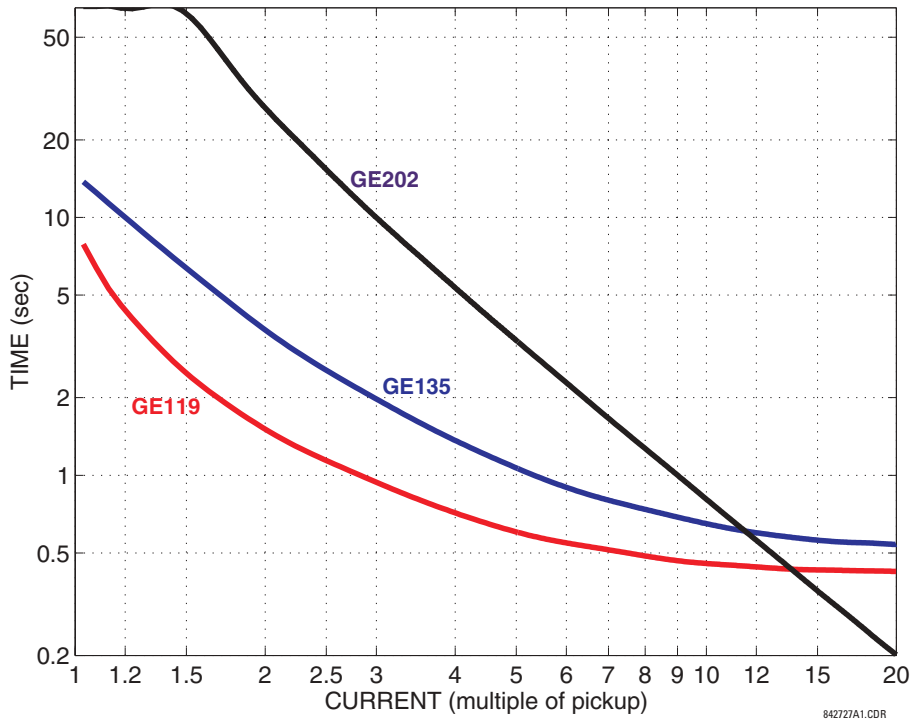

Figure 5-24: RECLOSER CURVES GE119, GE135, AND GE202

5.4.1 INTRODUCTION TO FLEXLOGIC™

To provide maximum flexibility to the user, the arrangement of internal digital logic combines fixed and user-programmed parameters. Logic upon which individual features are designed is fixed, and all other logic, from digital input signals through elements or combinations of elements to digital outputs, is variable. The user has complete control of all variable logic through FlexLogic™. In general, the system receives analog and digital inputs which it uses to produce analog and digital outputs. The major sub-systems of a generic UR-series relay involved in this process are shown below.

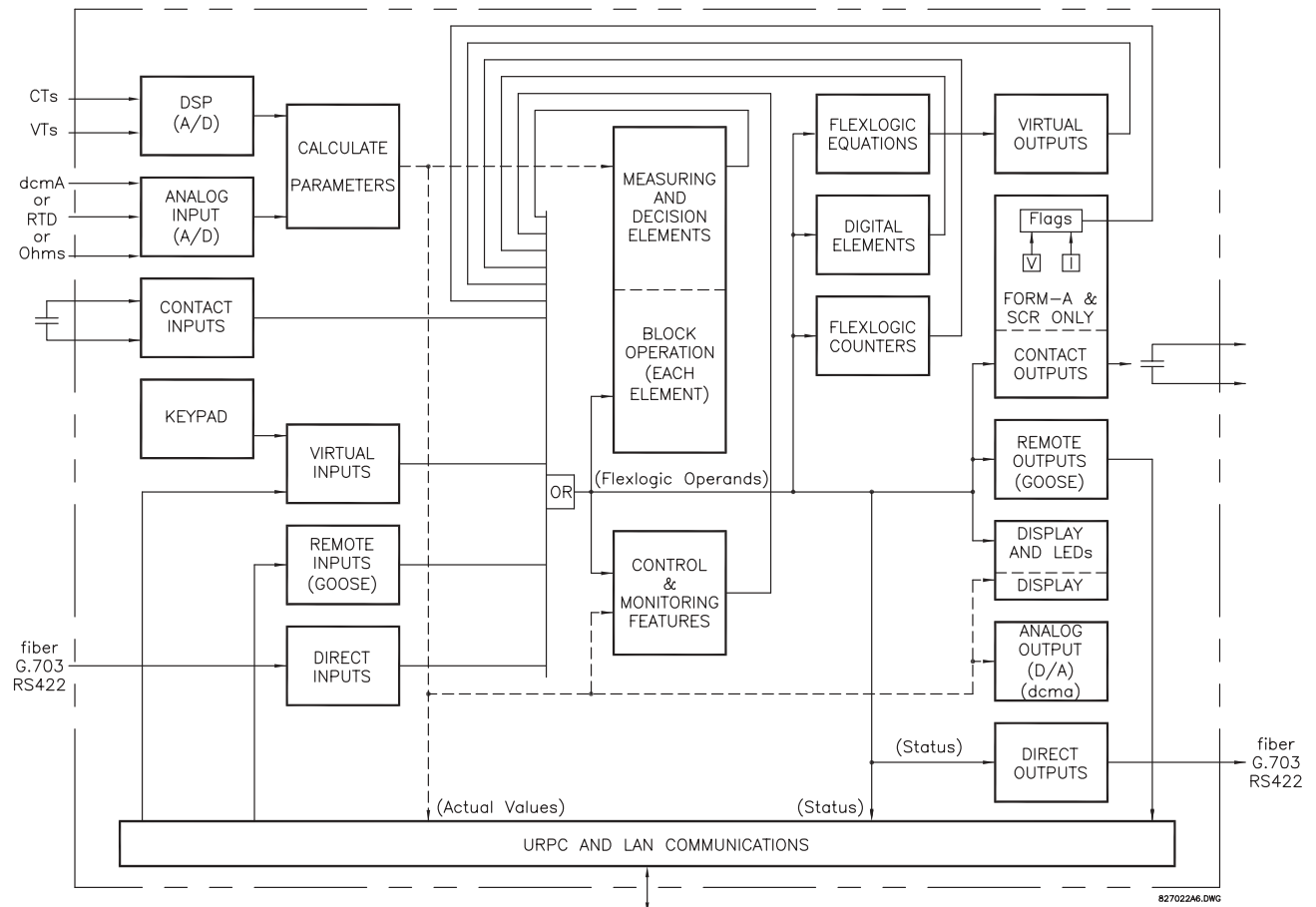

Figure 5-25: UR ARCHITECTURE OVERVIEW

The states of all digital signals used in the F35 are represented by flags (or FlexLogic™ operands, which are described later in this section). A digital “1” is represented by a 'set' flag. Any external contact change-of-state can be used to block an element from operating, as an input to a control feature in a FlexLogic™ equation, or to operate a contact output. The state of the contact input can be displayed locally or viewed remotely via the communications facilities provided. If a simple scheme where a contact input is used to block an element is desired, this selection is made when programming the element. This capability also applies to the other features that set flags: elements, virtual inputs, remote inputs, schemes, and human operators.

If more complex logic than presented above is required, it is implemented via FlexLogic™. For example, if it is desired to have the closed state of contact input H7a and the operated state of the phase undervoltage element block the operation of the phase time overcurrent element, the two control input states are programmed in a FlexLogic™ equation. This equation ANDs the two control inputs to produce a 'virtual output' which is then selected when programming the phase time overcurrent to be used as a blocking input. Virtual outputs can only be created by FlexLogic™ equations.

Traditionally, protective relay logic has been relatively limited. Any unusual applications involving interlocks, blocking, or supervisory functions had to be hard-wired using contact inputs and outputs. FlexLogic™ minimizes the requirement for auxiliary components and wiring while making more complex schemes possible.

The logic that determines the interaction of inputs, elements, schemes and outputs is field programmable through the use of logic equations that are sequentially processed. The use of virtual inputs and outputs in addition to hardware is available internally and on the communication ports for other relays to use (distributed FlexLogic™).

FlexLogic™ allows users to customize the relay through a series of equations that consist of operators and operands. The operands are the states of inputs, elements, schemes and outputs. The operators are logic gates, timers and latches (with set and reset inputs). A system of sequential operations allows any combination of specified operands to be assigned as inputs to specified operators to create an output. The final output of an equation is a numbered register called a virtual output. Virtual outputs can be used as an input operand in any equation, including the equation that generates the output, as a seal-in or other type of feedback.

A FlexLogic™ equation consists of parameters that are either operands or operators. Operands have a logic state of 1 or 0. Operators provide a defined function, such as an AND gate or a Timer. Each equation defines the combinations of parameters to be used to set a Virtual Output flag. Evaluation of an equation results in either a 1 (=ON, i.e. flag set) or 0 (=OFF, i.e. flag not set). Each equation is evaluated at least 4 times every power system cycle.

Some types of operands are present in the relay in multiple instances; e.g. contact and remote inputs. These types of operands are grouped together (for presentation purposes only) on the faceplate display. The characteristics of the different types of operands are listed in the table below.

Table 5–4: F35 FLEXLOGIC™ OPERAND TYPES

OPERAND TYPE	STATE	EXAMPLE FORMAT	CHARACTERISTICS [INPUT IS '1' (= ON) IF...]
Contact Input	On	Cont Ip On	Voltage is presently applied to the input (external contact closed).
	Off	Cont Ip Off	Voltage is presently not applied to the input (external contact open).
Contact Output (type Form-A contact only)	Voltage On	Cont Op 1 VOn	Voltage exists across the contact.
	Voltage Off	Cont Op 1 VOff	Voltage does not exist across the contact.
	Current On	Cont Op 1 IOOn	Current is flowing through the contact.
	Current Off	Cont Op 1 IOOff	Current is not flowing through the contact.
Direct Input	On	DIRECT INPUT 1 On	The direct input is presently in the ON state.
Element (Analog)	Pickup	PHASE TOC1 PKP	The tested parameter is presently above the pickup setting of an element which responds to rising values or below the pickup setting of an element which responds to falling values.
	Dropout	PHASE TOC1 DPO	This operand is the logical inverse of the above PKP operand.
	Operate	PHASE TOC1 OP	The tested parameter has been above/below the pickup setting of the element for the programmed delay time, or has been at logic 1 and is now at logic 0 but the reset timer has not finished timing.
	Block	PH DIR1 BLK	The output of the comparator is set to the block function.
Element (Digital)	Pickup	Dig Element 1 PKP	The input operand is at logic 1.
	Dropout	Dig Element 1 DPO	This operand is the logical inverse of the above PKP operand.
	Operate	Dig Element 1 OP	The input operand has been at logic 1 for the programmed pickup delay time, or has been at logic 1 for this period and is now at logic 0 but the reset timer has not finished timing.
Element (Digital Counter)	Higher than	Counter 1 HI	The number of pulses counted is above the set number.
	Equal to	Counter 1 EQL	The number of pulses counted is equal to the set number.
	Lower than	Counter 1 LO	The number of pulses counted is below the set number.
Fixed	On	On	Logic 1
	Off	Off	Logic 0
Remote Input	On	REMOTE INPUT 1 On	The remote input is presently in the ON state.
Virtual Input	On	Virt Ip 1 On	The virtual input is presently in the ON state.
Virtual Output	On	Virt Op 1 On	The virtual output is presently in the set state (i.e. evaluation of the equation which produces this virtual output results in a "1").

The operands available for this relay are listed alphabetically by types in the following table.

Table 5–5: F35 FLEXLOGIC™ OPERANDS (Sheet 1 of 4)

OPERAND TYPE	OPERAND SYNTAX	OPERAND DESCRIPTION
CONTROL PUSHBUTTONS	CONTROL PUSHBTN n ON	Control Pushbutton n ($n = 1$ to 7) is being pressed.
DIRECT DEVICES	DIRECT DEVICE 1On ↓ DIRECT DEVICE 16On DIRECT DEVICE 1Off ↓ DIRECT DEVICE 16Off	Flag is set, logic=1 ↓ Flag is set, logic=1 Flag is set, logic=1 ↓ Flag is set, logic=1
DIRECT INPUT/ OUTPUT CHANNEL MONITORING	DIR IO CH1(2) CRC ALARM DIR IO CRC ALARM DIR IO CH1(2) UNRET ALM DIR IO UNRET ALM	The rate of Direct Input messages received on Channel 1(2) and failing the CRC exceeded the user-specified level. The rate of Direct Input messages failing the CRC exceeded the user-specified level on Channel 1 or 2. The rate of returned direct input/output messages on Channel 1(2) exceeded the user-specified level (ring configurations only). The rate of returned direct input/output messages exceeded the user-specified level on Channel 1 or 2 (ring configurations only).
ELEMENT: 8-Bit Switch	8BIT SWITCH 1 BIT 0 8BIT SWITCH 1 BIT 1 8BIT SWITCH 1 BIT 2 8BIT SWITCH 1 BIT 3 8BIT SWITCH 1 BIT 4 8BIT SWITCH 1 BIT 5 8BIT SWITCH 1 BIT 6 8BIT SWITCH 1 BIT 7 8BIT SWITCH 2 to 8BIT SWITCH 6	Bit 0 of Eight-Bit Switch 1 asserted (the least significant bit) Bit 1 of Eight-Bit Switch 1 asserted Bit 2 of Eight-Bit Switch 1 asserted Bit 3 of Eight-Bit Switch 1 asserted Bit 4 of Eight-Bit Switch 1 asserted Bit 5 of Eight-Bit Switch 1 asserted Bit 6 of Eight-Bit Switch 1 asserted Bit 7 of Eight-Bit Switch 1 asserted (the most significant bit) Same set of operands as shown for 8 BIT SWITCH 1 above
ELEMENT: Autoreclose (per CT bank)	AR 1 ENABLED AR 1 RIP AR 1 LO AR 1 BLK FROM MAN CL AR 1 CLOSE AR 1 SHOT CNT=0 ↓ AR 1 SHOT CNT=4 AR 1 DISABLED AR 2 to AR3	Autoreclose 1 is enabled Autoreclose 1 is in progress Autoreclose 1 is locked out Autoreclose 1 is temporarily disabled Autoreclose 1 close command is issued Autoreclose 1 shot count is 0 Autoreclose 1 shot count is 4 Autoreclose 1 is disabled Same set of operands as shown for AR 1
ELEMENT: Auxiliary Overvoltage	AUX OV1 PKP AUX OV1 DPO AUX OV1 OP	Auxiliary Overvoltage element has picked up Auxiliary Overvoltage element has dropped out Auxiliary Overvoltage element has operated
ELEMENT: Auxiliary Undervoltage	AUX UV1 PKP AUX UV1 DPO AUX UV1 OP	Auxiliary Undervoltage element has picked up Auxiliary Undervoltage element has dropped out Auxiliary Undervoltage element has operated
ELEMENT: Breaker Arcing	BKR ARC 1 OP BKR ARC 2 OP	Breaker Arcing Current 1 has operated Breaker Arcing Current 2 has operated
ELEMENT: Digital Counters	Counter 1 HI Counter 1 EQL Counter 1 LO ↓ Counter 8 HI Counter 8 EQL Counter 8 LO	Digital Counter 1 output is 'more than' comparison value Digital Counter 1 output is 'equal to' comparison value Digital Counter 1 output is 'less than' comparison value ↓ Digital Counter 8 output is 'more than' comparison value Digital Counter 8 output is 'equal to' comparison value Digital Counter 8 output is 'less than' comparison value
ELEMENT: Digital Elements	Dig Element 1 PKP Dig Element 1 OP Dig Element 1 DPO ↓ Dig Element 16 PKP Dig Element 16 OP Dig Element 16 DPO	Digital Element 1 is picked up Digital Element 1 is operated Digital Element 1 is dropped out ↓ Digital Element 16 is picked up Digital Element 16 is operated Digital Element 16 is dropped out
ELEMENT: FlexElements™	FxE 1 PKP FxE 1 OP FxE 1 DPO ↓ FxE 8 PKP FxE 8 OP FxE 8 DPO	FlexElement™ 1 has picked up FlexElement™ 1 has operated FlexElement™ 1 has dropped out ↓ FlexElement™ 8 has picked up FlexElement™ 8 has operated FlexElement™ 8 has dropped out

Table 5–5: F35 FLEXLOGIC™ OPERANDS (Sheet 2 of 4)

OPERAND TYPE	OPERAND SYNTAX	OPERAND DESCRIPTION
ELEMENT: Ground Instantaneous Overcurrent	GROUND IOC1 PKP GROUND IOC1 OP GROUND IOC1 DPO	Ground Instantaneous Overcurrent 1 has picked up Ground Instantaneous Overcurrent 1 has operated Ground Instantaneous Overcurrent 1 has dropped out
	GROUND IOC2 to IOC12	Same set of operands as shown for GROUND IOC 1
ELEMENT: Ground Time Overcurrent	GROUND TOC1 PKP GROUND TOC1 OP GROUND TOC1 DPO	Ground Time Overcurrent 1 has picked up Ground Time Overcurrent 1 has operated Ground Time Overcurrent 1 has dropped out
	GROUND TOC2 to TOC6	Same set of operands as shown for GROUND TOC1
ELEMENT Non-Volatile Latches	LATCH 1 ON LATCH 1 OFF ↓ LATCH 16 ON LATCH 16 OFF	Non-Volatile Latch 1 is ON (Logic = 1) Non-Voltage Latch 1 is OFF (Logic = 0) ↓ Non-Volatile Latch 16 is ON (Logic = 1) Non-Voltage Latch 16 is OFF (Logic = 0)
	NEUTRAL IOC1 PKP NEUTRAL IOC1 OP NEUTRAL IOC1 DPO	Neutral Instantaneous Overcurrent 1 has picked up Neutral Instantaneous Overcurrent 1 has operated Neutral Instantaneous Overcurrent 1 has dropped out
	NEUTRAL IOC2 to IOC12	Same set of operands as shown for NEUTRAL IOC1
ELEMENT: Neutral Overvoltage	NEUTRAL OV1 PKP NEUTRAL OV1 DPO NEUTRAL OV1 OP	Neutral Overvoltage element has picked up Neutral Overvoltage element has dropped out Neutral Overvoltage element has operated
ELEMENT: Neutral Time Overcurrent	NEUTRAL TOC1 PKP NEUTRAL TOC1 OP NEUTRAL TOC1 DPO	Neutral Time Overcurrent 1 has picked up Neutral Time Overcurrent 1 has operated Neutral Time Overcurrent 1 has dropped out
	NEUTRAL TOC2 to TOC6	Same set of operands as shown for NEUTRAL TOC1
ELEMENT: Phase Instantaneous Overcurrent	PHASE IOC1 PKP PHASE IOC1 OP PHASE IOC1 DPO PHASE IOC1 PKP A PHASE IOC1 PKP B PHASE IOC1 PKP C PHASE IOC1 OP A PHASE IOC1 OP B PHASE IOC1 OP C PHASE IOC1 DPO A PHASE IOC1 DPO B PHASE IOC1 DPO C	At least one phase of PHASE IOC1 has picked up At least one phase of PHASE IOC1 has operated At least one phase of PHASE IOC1 has dropped out Phase A of PHASE IOC1 has picked up Phase B of PHASE IOC1 has picked up Phase C of PHASE IOC1 has picked up Phase A of PHASE IOC1 has operated Phase B of PHASE IOC1 has operated Phase C of PHASE IOC1 has operated Phase A of PHASE IOC1 has dropped out Phase B of PHASE IOC1 has dropped out Phase C of PHASE IOC1 has dropped out
	PHASE IOC2 to IOC12	Same set of operands as shown for PHASE IOC1
ELEMENT: Phase Time Overcurrent	PHASE TOC1 PKP PHASE TOC1 OP PHASE TOC1 DPO PHASE TOC1 PKP A PHASE TOC1 PKP B PHASE TOC1 PKP C PHASE TOC1 OP A PHASE TOC1 OP B PHASE TOC1 OP C PHASE TOC1 DPO A PHASE TOC1 DPO B PHASE TOC1 DPO C	At least one phase of PHASE TOC1 has picked up At least one phase of PHASE TOC1 has operated At least one phase of PHASE TOC1 has dropped out Phase A of PHASE TOC1 has picked up Phase B of PHASE TOC1 has picked up Phase C of PHASE TOC1 has picked up Phase A of PHASE TOC1 has operated Phase B of PHASE TOC1 has operated Phase C of PHASE TOC1 has operated Phase A of PHASE TOC1 has dropped out Phase B of PHASE TOC1 has dropped out Phase C of PHASE TOC1 has dropped out
	PHASE TOC2 to TOC6	Same set of operands as shown for PHASE TOC1
ELEMENT: Phase Undervoltage	PHASE UV1 PKP PHASE UV1 OP PHASE UV1 DPO PHASE UV1 PKP A PHASE UV1 PKP B PHASE UV1 PKP C PHASE UV1 OP A PHASE UV1 OP B PHASE UV1 OP C PHASE UV1 DPO A PHASE UV1 DPO B PHASE UV1 DPO C	At least one phase of UV1 has picked up At least one phase of UV1 has operated At least one phase of UV1 has dropped out Phase A of UV1 has picked up Phase B of UV1 has picked up Phase C of UV1 has picked up Phase A of UV1 has operated Phase B of UV1 has operated Phase C of UV1 has operated Phase A of UV1 has dropped out Phase B of UV1 has dropped out Phase C of UV1 has dropped out
	PHASE UV2	Same set of operands as shown for PHASE UV1

Table 5–5: F35 FLEXLOGIC™ OPERANDS (Sheet 3 of 4)

OPERAND TYPE	OPERAND SYNTAX	OPERAND DESCRIPTION
ELEMENT: Selector Switch	SELECTOR 1 POS Y SELECTOR 1 BIT 0 SELECTOR 1 BIT 1 SELECTOR 1 BIT 2 SELECTOR 1 STP ALARM SELECTOR 1 BIT ALARM SELECTOR 1 ALARM SELECTOR 1 PWR ALARM	Selector Switch 1 is in Position Y (mutually exclusive operands). First bit of the 3-bit word encoding position of Selector 1. Second bit of the 3-bit word encoding position of Selector 1. Third bit of the 3-bit word encoding position of Selector 1. Position of Selector 1 has been pre-selected with the stepping up control input but not acknowledged. Position of Selector 1 has been pre-selected with the 3-bit control input but not acknowledged. Position of Selector 1 has been pre-selected but not acknowledged. Position of Selector Switch 1 is undetermined when the relay powers up and synchronizes to the 3-bit input.
	SELECTOR 2	Same set of operands as shown above for SELECTOR 1
ELEMENT: Setting Group	SETTING GROUP ACT 1 ↓ SETTING GROUP ACT 6	Setting Group 1 is active ↓ Setting Group 6 is active
	UNDERFREQ 1 PKP UNDERFREQ 1 OP UNDERFREQ 1 DPO	Underfrequency 1 has picked up Underfrequency 1 has operated Underfrequency 1 has dropped out
FIXED OPERANDS	Off	Logic = 0. Does nothing and may be used as a delimiter in an equation list; used as 'Disable' by other features.
	On	Logic = 1. Can be used as a test setting.
INPUTS/OUTPUTS: Contact Inputs	Cont Ip 1 On Cont Ip 2 On ↓ Cont Ip 1 Off Cont Ip 2 Off	(will not appear unless ordered) (will not appear unless ordered) ↓ (will not appear unless ordered) (will not appear unless ordered)
	Cont Op 1 IOn Cont Op 2 IOn ↓ Cont Op 1 IOff Cont Op 2 IOff	(will not appear unless ordered) (will not appear unless ordered) ↓ (will not appear unless ordered) (will not appear unless ordered)
INPUTS/OUTPUTS: Contact Outputs, Current (from detector on Form-A output only)	Cont Op 1 VOn Cont Op 2 VOn ↓ Cont Op 1 VOff Cont Op 2 VOff	(will not appear unless ordered) (will not appear unless ordered) ↓ (will not appear unless ordered) (will not appear unless ordered)
	DIRECT INPUT 1 On ↓ DIRECT INPUT 32 On	Flag is set, logic=1 ↓ Flag is set, logic=1
INPUTS/OUTPUTS: Remote Inputs	REMOTE INPUT 1 On ↓ REMOTE INPUT 32 On	Flag is set, logic=1 ↓ Flag is set, logic=1
INPUTS/OUTPUTS: Virtual Inputs	Virt Ip 1 On ↓ Virt Ip 32 On	Flag is set, logic=1 ↓ Flag is set, logic=1
INPUTS/OUTPUTS: Virtual Outputs	Virt Op 1 On ↓ Virt Op 64 On	Flag is set, logic=1 ↓ Flag is set, logic=1
LED TEST	LED TEST IN PROGRESS	An LED test has been initiated and has not finished.
REMOTE DEVICES	REMOTE DEVICE 1 On ↓ REMOTE DEVICE 16 On	Flag is set, logic=1 ↓ Flag is set, logic=1
	REMOTE DEVICE 1 Off ↓ REMOTE DEVICE 16 Off	Flag is set, logic=1 ↓ Flag is set, logic=1
RESETTING	RESET OP RESET OP (COMMS) RESET OP (OPERAND) RESET OP (PUSHBUTTON)	Reset command is operated (set by all 3 operands below) Communications source of the reset command Operand (assigned in the INPUTS/OUTPUTS ⇌ RESETTING menu) source of the reset command Reset key (pushbutton) source of the reset command

Table 5–5: F35 FLEXLOGIC™ OPERANDS (Sheet 4 of 4)

OPERAND TYPE	OPERAND SYNTAX	OPERAND DESCRIPTION
SELF-DIAGNOSTICS	ANY MAJOR ERROR ANY MINOR ERROR ANY SELF-TEST BATTERY FAIL DIRECT DEVICE OFF DIRECT RING BREAK DSP ERROR EEPROM DATA ERROR EQUIPMENT MISMATCH FLEXLOGIC ERR TOKEN IRIG-B FAILURE LATCHING OUT ERROR LOW ON MEMORY NO DSP INTERRUPTS PRI ETHERNET FAIL PROGRAM MEMORY PROTOTYPE FIRMWARE REMOTE DEVICE OFF SEC ETHERNET FAIL SNTP FAILURE SYSTEM EXCEPTION UNIT NOT CALIBRATED UNIT NOT PROGRAMMED WATCHDOG ERROR	Any of the major self-test errors generated (major error) Any of the minor self-test errors generated (minor error) Any self-test errors generated (generic, any error) See description in Chapter 7: Commands and Targets.
UNAUTHORIZED ACCESS ALARM	UNAUTHORIZED ACCESS	Asserted when a password entry fails while accessing a password-protected level of the relay.
USER-PROGRAMMABLE PUSHBUTTONS	PUSHBUTTON x ON PUSHBUTTON x OFF	Pushbutton Number x is in the 'On' position Pushbutton Number x is in the 'Off' position

5

Some operands can be re-named by the user. These are the names of the breakers in the breaker control feature, the ID (identification) of contact inputs, the ID of virtual inputs, and the ID of virtual outputs. If the user changes the default name/ID of any of these operands, the assigned name will appear in the relay list of operands. The default names are shown in the FlexLogic™ operands table above.

The characteristics of the logic gates are tabulated below, and the operators available in FlexLogic™ are listed in the Flex-Logic™ operators table.

Table 5–6: FLEXLOGIC™ GATE CHARACTERISTICS

GATES	NUMBER OF INPUTS	OUTPUT IS '1' (= ON) IF...
NOT	1	input is '0'
OR	2 to 16	any input is '1'
AND	2 to 16	all inputs are '1'
NOR	2 to 16	all inputs are '0'
NAND	2 to 16	any input is '0'
XOR	2	only one input is '1'

Table 5-7: FLEXLOGIC™ OPERATORS

TYPE	SYNTAX	DESCRIPTION	NOTES
Editor	INSERT	Insert a parameter in an equation list.	
	DELETE	Delete a parameter from an equation list.	
End	END	The first END encountered signifies the last entry in the list of processed FlexLogic™ parameters.	
One Shot	POSITIVE ONE SHOT	One shot that responds to a positive going edge.	A 'one shot' refers to a single input gate that generates a pulse in response to an edge on the input. The output from a 'one shot' is True (positive) for only one pass through the FlexLogic™ equation. There is a maximum of 32 'one shots'.
	NEGATIVE ONE SHOT	One shot that responds to a negative going edge.	
	DUAL ONE SHOT	One shot that responds to both the positive and negative going edges.	
Logic Gate	NOT	Logical Not	Operates on the previous parameter.
	OR(2)	2 input OR gate	Operates on the 2 previous parameters.
	OR(16)	16 input OR gate	Operates on the 16 previous parameters.
	AND(2)	2 input AND gate	Operates on the 2 previous parameters.
	AND(16)	16 input AND gate	Operates on the 16 previous parameters.
	NOR(2)	2 input NOR gate	Operates on the 2 previous parameters.
	NOR(16)	16 input NOR gate	Operates on the 16 previous parameters.
	NAND(2)	2 input NAND gate	Operates on the 2 previous parameters.
NAND(16)	16 input NAND gate	Operates on the 16 previous parameters.	
Timer	TIMER 1	Timer set with FlexLogic™ Timer 1 settings.	The timer is started by the preceding parameter. The output of the timer is TIMER #.
	TIMER 32	Timer set with FlexLogic™ Timer 32 settings.	
Assign Virtual Output	= Virt Op 1	Assigns previous FlexLogic™ parameter to Virtual Output 1.	The virtual output is set by the preceding parameter
	= Virt Op 64	Assigns previous FlexLogic™ parameter to Virtual Output 64.	

5.4.2 FLEXLOGIC™ RULES

When forming a FlexLogic™ equation, the sequence in the linear array of parameters must follow these general rules:

1. Operands must precede the operator which uses the operands as inputs.
2. Operators have only one output. The output of an operator must be used to create a virtual output if it is to be used as an input to two or more operators.
3. Assigning the output of an operator to a Virtual Output terminates the equation.
4. A timer operator (e.g. "TIMER 1") or virtual output assignment (e.g. "= Virt Op 1") may only be used once. If this rule is broken, a syntax error will be declared.

5.4.3 FLEXLOGIC™ EVALUATION

Each equation is evaluated in the order in which the parameters have been entered.



FlexLogic™ provides latches which by definition have a memory action, remaining in the set state after the set input has been asserted. However, they are *volatile*; i.e. they reset on the re-application of control power.

When making changes to settings, all FlexLogic™ equations are re-compiled whenever any new setting value is entered, so all latches are automatically reset. If it is necessary to re-initialize FlexLogic™ during testing, for example, it is suggested to power the unit down and then back up.

5.4.4 FLEXLOGIC™ EXAMPLE

This section provides an example of implementing logic for a typical application. The sequence of the steps is quite important as it should minimize the work necessary to develop the relay settings. Note that the example presented in the figure below is intended to demonstrate the procedure, not to solve a specific application situation.

In the example below, it is assumed that logic has already been programmed to produce Virtual Outputs 1 and 2, and is only a part of the full set of equations used. When using FlexLogic™, it is important to make a note of each Virtual Output used – a Virtual Output designation (1 to 64) can only be properly assigned once.

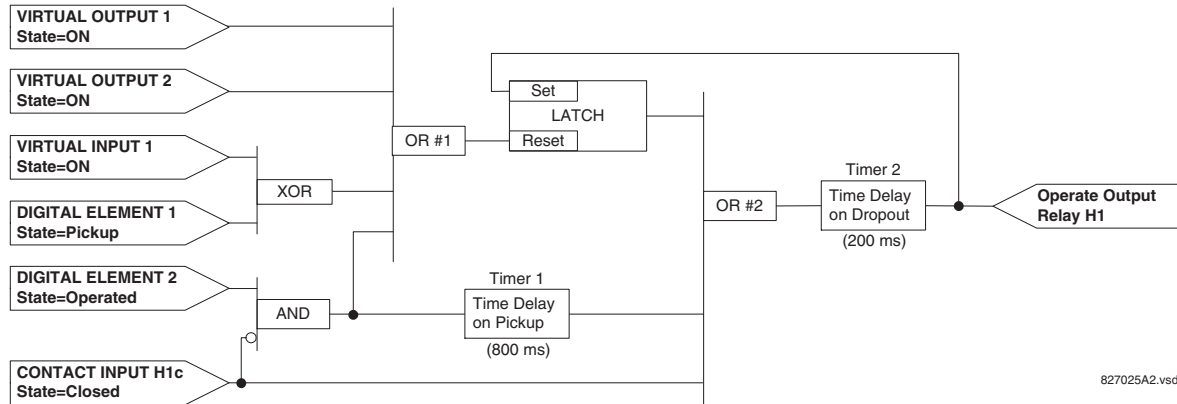

Figure 5-26: EXAMPLE LOGIC SCHEME

5

1. Inspect the example logic diagram to determine if the required logic can be implemented with the FlexLogic™ operators. If this is not possible, the logic must be altered until this condition is satisfied. Once this is done, count the inputs to each gate to verify that the number of inputs does not exceed the FlexLogic™ limits, which is unlikely but possible. If the number of inputs is too high, subdivide the inputs into multiple gates to produce an equivalent. For example, if 25 inputs to an AND gate are required, connect Inputs 1 through 16 to AND(16), 17 through 25 to AND(9), and the outputs from these two gates to AND(2).

Inspect each operator between the initial operands and final virtual outputs to determine if the output from the operator is used as an input to more than one following operator. If so, the operator output must be assigned as a Virtual Output.

For the example shown above, the output of the AND gate is used as an input to both OR#1 and Timer 1, and must therefore be made a Virtual Output and assigned the next available number (i.e. Virtual Output 3). The final output must also be assigned to a Virtual Output as Virtual Output 4, which will be programmed in the contact output section to operate relay H1 (i.e. Output Contact H1).

Therefore, the required logic can be implemented with two FlexLogic™ equations with outputs of Virtual Output 3 and Virtual Output 4 as shown below.

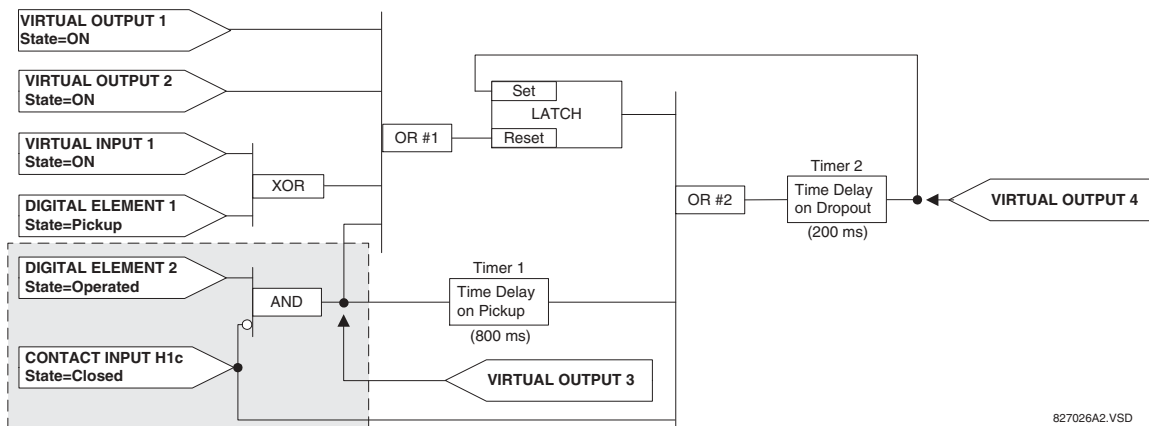

Figure 5-27: LOGIC EXAMPLE WITH VIRTUAL OUTPUTS

2. Prepare a logic diagram for the equation to produce Virtual Output 3, as this output will be used as an operand in the Virtual Output 4 equation (create the equation for every output that will be used as an operand first, so that when these operands are required they will already have been evaluated and assigned to a specific Virtual Output). The logic for Virtual Output 3 is shown below with the final output assigned.

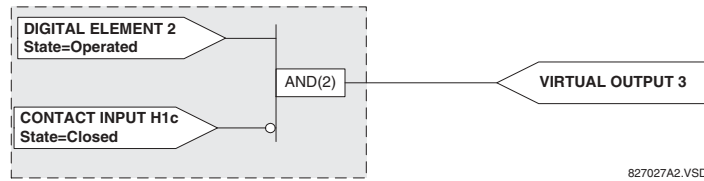

Figure 5–28: LOGIC FOR VIRTUAL OUTPUT 3

3. Prepare a logic diagram for Virtual Output 4, replacing the logic ahead of Virtual Output 3 with a symbol identified as Virtual Output 3, as shown below.

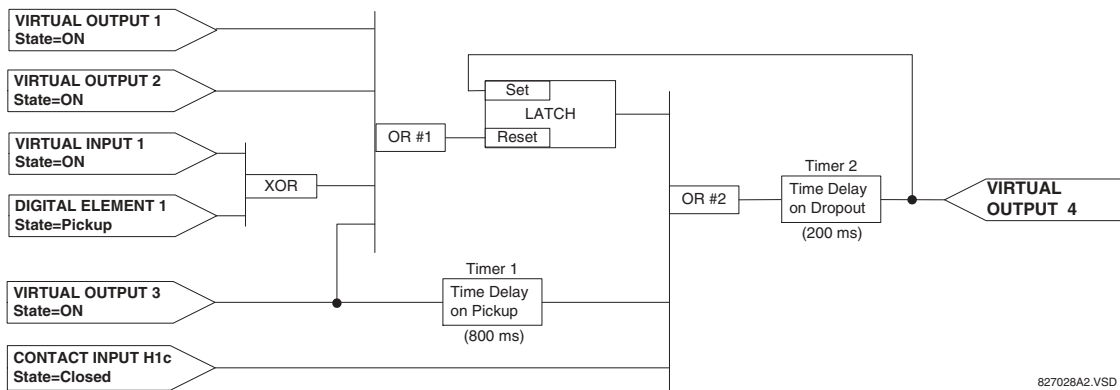

Figure 5–29: LOGIC FOR VIRTUAL OUTPUT 4

4. Program the FlexLogic™ equation for Virtual Output 3 by translating the logic into available FlexLogic™ parameters. The equation is formed one parameter at a time until the required logic is complete. It is generally easier to start at the output end of the equation and work back towards the input, as shown in the following steps. It is also recommended to list operator inputs from bottom to top. For demonstration, the final output will be arbitrarily identified as parameter 99, and each preceding parameter decremented by one in turn. Until accustomed to using FlexLogic™, it is suggested that a worksheet with a series of cells marked with the arbitrary parameter numbers be prepared, as shown below.

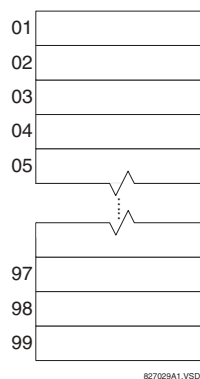

Figure 5–30: FLEXLOGIC™ WORKSHEET

5. Following the procedure outlined, start with parameter 99, as follows:
 - 99: The final output of the equation is Virtual Output 3, which is created by the operator "= Virt Op n". This parameter is therefore "= Virt Op 3."

- 98: The gate preceding the output is an AND, which in this case requires two inputs. The operator for this gate is a 2-input AND so the parameter is "AND(2)". Note that FlexLogic™ rules require that the number of inputs to most types of operators must be specified to identify the operands for the gate. As the 2-input AND will operate on the two operands preceding it, these inputs must be specified, starting with the lower.
- 97: This lower input to the AND gate must be passed through an inverter (the NOT operator) so the next parameter is "NOT". The NOT operator acts upon the operand immediately preceding it, so specify the inverter input next.
- 96: The input to the NOT gate is to be contact input H1c. The ON state of a contact input can be programmed to be set when the contact is either open or closed. Assume for this example the state is to be ON for a closed contact. The operand is therefore "Cont Ip H1c On".
- 95: The last step in the procedure is to specify the upper input to the AND gate, the operated state of digital element 2. This operand is "DIG ELEM 2 OP".

Writing the parameters in numerical order can now form the equation for VIRTUAL OUTPUT 3:

```
[95] DIG ELEM 2 OP
[96] Cont Ip H1c On
[97] NOT
[98] AND (2)
[99] = Virt Op 3
```

It is now possible to check that this selection of parameters will produce the required logic by converting the set of parameters into a logic diagram. The result of this process is shown below, which is compared to the Logic for Virtual Output 3 diagram as a check.

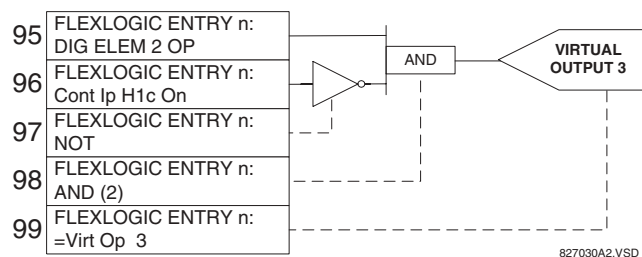

Figure 5–31: FLEXLOGIC™ EQUATION FOR VIRTUAL OUTPUT 3

6. Repeating the process described for VIRTUAL OUTPUT 3, select the FlexLogic™ parameters for Virtual Output 4.
- 99: The final output of the equation is VIRTUAL OUTPUT 4 which is parameter "= Virt Op 4".
- 98: The operator preceding the output is Timer 2, which is operand "TIMER 2". Note that the settings required for the timer are established in the timer programming section.
- 97: The operator preceding Timer 2 is OR #2, a 3-input OR, which is parameter "OR(3)".
- 96: The lowest input to OR #2 is operand "Cont Ip H1c On".
- 95: The center input to OR #2 is operand "TIMER 1".
- 94: The input to Timer 1 is operand "Virt Op 3 On".
- 93: The upper input to OR #2 is operand "LATCH (S,R)".
- 92: There are two inputs to a latch, and the input immediately preceding the latch reset is OR #1, a 4-input OR, which is parameter "OR(4)".
- 91: The lowest input to OR #1 is operand "Virt Op 3 On".
- 90: The input just above the lowest input to OR #1 is operand "XOR(2)".
- 89: The lower input to the XOR is operand "DIG ELEM 1 PKP".
- 88: The upper input to the XOR is operand "Virt Ip 1 On".
- 87: The input just below the upper input to OR #1 is operand "Virt Op 2 On".
- 86: The upper input to OR #1 is operand "Virt Op 1 On".
- 85: The last parameter is used to set the latch, and is operand "Virt Op 4 On".

The equation for VIRTUAL OUTPUT 4 is:

```
[85] Virt Op 4 On
[86] Virt Op 1 On
[87] Virt Op 2 On
[88] Virt Ip 1 On
[89] DIG ELEM 1 PKP
[90] XOR(2)
[91] Virt Op 3 On
[92] OR(4)
[93] LATCH (S,R)
[94] Virt Op 3 On
[95] TIMER 1
[96] Cont Ip H1c On
[97] OR(3)
[98] TIMER 2
[99] = Virt Op 4
```

It is now possible to check that the selection of parameters will produce the required logic by converting the set of parameters into a logic diagram. The result of this process is shown below, which is compared to the Logic for Virtual Output 4 diagram as a check.

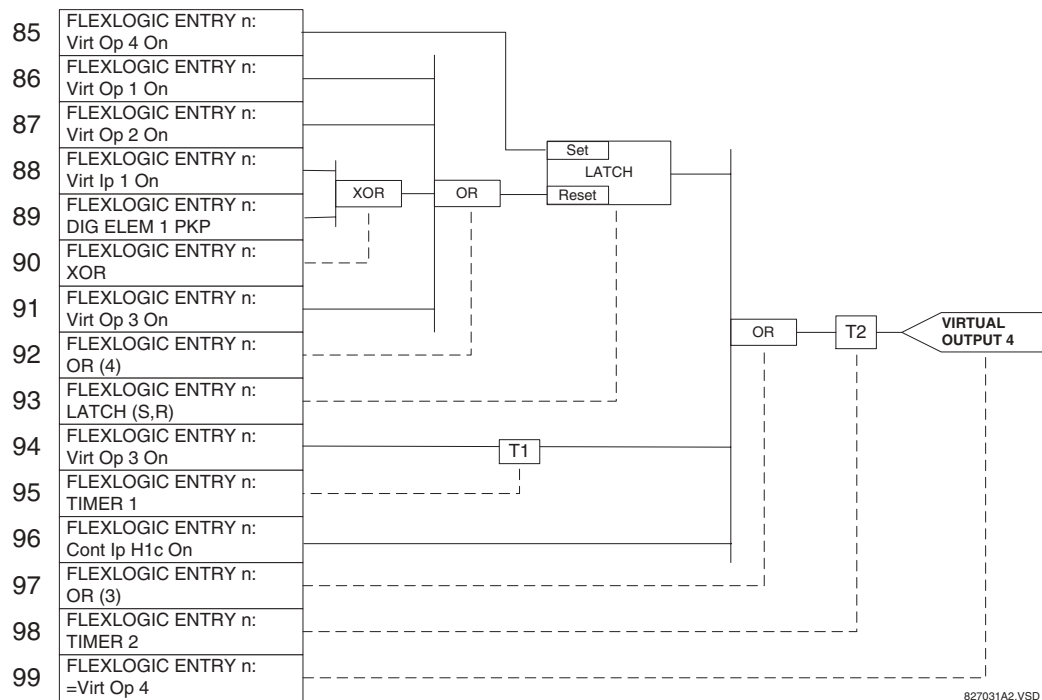

Figure 5–32: FLEXLOGIC™ EQUATION FOR VIRTUAL OUTPUT 4

- Now write the complete FlexLogic™ expression required to implement the logic, making an effort to assemble the equation in an order where Virtual Outputs that will be used as inputs to operators are created before needed. In cases where a lot of processing is required to perform logic, this may be difficult to achieve, but in most cases will not cause problems as all logic is calculated at least 4 times per power frequency cycle. The possibility of a problem caused by sequential processing emphasizes the necessity to test the performance of FlexLogic™ before it is placed in service.

In the following equation, Virtual Output 3 is used as an input to both Latch 1 and Timer 1 as arranged in the order shown below:

```
DIG ELEM 2 OP
Cont Ip H1c On
NOT
AND(2)
```

```

= Virt Op 3
Virt Op 4 On
Virt Op 1 On
Virt Op 2 On
Virt Ip 1 On
DIG ELEM 1 PKP
XOR(2)
Virt Op 3 On
OR(4)
LATCH (S,R)
Virt Op 3 On
TIMER 1
Cont Ip H1c On
OR(3)
TIMER 2
= Virt Op 4
END

```

In the expression above, the Virtual Output 4 input to the 4-input OR is listed before it is created. This is typical of a form of feedback, in this case, used to create a seal-in effect with the latch, and is correct.

- The logic should always be tested after it is loaded into the relay, in the same fashion as has been used in the past. Testing can be simplified by placing an "END" operator within the overall set of FlexLogic™ equations. The equations will then only be evaluated up to the first "END" operator.

The "On" and "Off" operands can be placed in an equation to establish a known set of conditions for test purposes, and the "INSERT" and "DELETE" commands can be used to modify equations.

5.4.5 FLEXLOGIC™ EQUATION EDITOR

PATH: SETTINGS ⇒ FLEXLOGIC ⇒ FLEXLOGIC EQUATION EDITOR

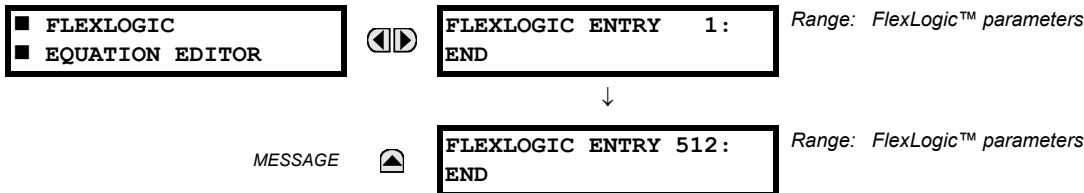

There are 512 FlexLogic™ entries available, numbered from 1 to 512, with default 'END' entry settings. If a "Disabled" Element is selected as a FlexLogic™ entry, the associated state flag will never be set to '1'. The '+/-' key may be used when editing FlexLogic™ equations from the keypad to quickly scan through the major parameter types.

5.4.6 FLEXLOGIC™ TIMERS

PATH: SETTINGS ⇒ FLEXLOGIC ⇒ FLEXLOGIC TIMERS ⇒ FLEXLOGIC TIMER 1(32)

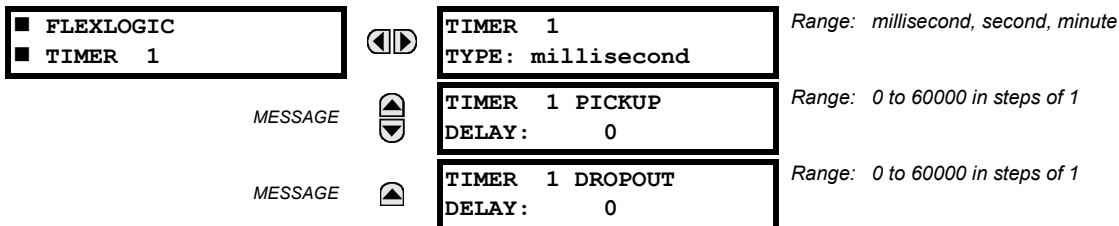

There are 32 identical FlexLogic™ timers available. These timers can be used as operators for FlexLogic™ equations.

- TIMER 1 TYPE:** This setting is used to select the time measuring unit.
- TIMER 1 PICKUP DELAY:** Sets the time delay to pickup. If a pickup delay is not required, set this function to "0".
- TIMER 1 DROPOUT DELAY:** Sets the time delay to dropout. If a dropout delay is not required, set this function to "0".

5.4.7 FLEXELEMENTS™

PATH: SETTING ⇨ ↓ FLEXLOGIC ⇨ ↓ FLEXELEMENTS ⇨ FLEXELEMENT 1(8)

■ FLEXELEMENT 1	◀▶	FLEXELEMENT 1 FUNCTION: Disabled	Range: Disabled, Enabled
MESSAGE	▲▼	FLEXELEMENT 1 NAME: FxE1	Range: up to 6 alphanumeric characters
MESSAGE	▲▼	FLEXELEMENT 1 +IN: Off	Range: Off, any analog actual value parameter
MESSAGE	▲▼	FLEXELEMENT 1 -IN: Off	Range: Off, any analog actual value parameter
MESSAGE	▲▼	FLEXELEMENT 1 INPUT MODE: Signed	Range: Signed, Absolute
MESSAGE	▲▼	FLEXELEMENT 1 COMP MODE: Level	Range: Level, Delta
MESSAGE	▲▼	FLEXELEMENT 1 DIRECTION: Over	Range: Over, Under
MESSAGE	▲▼	FLEXELEMENT 1 PICKUP: 1.000 pu	Range: -90.000 to 90.000 pu in steps of 0.001
MESSAGE	▲▼	FLEXELEMENT 1 HYSTERESIS: 3.0%	Range: 0.1 to 50.0% in steps of 0.1
MESSAGE	▲▼	FLEXELEMENT 1 dt UNIT: milliseconds	Range: milliseconds, seconds, minutes
MESSAGE	▲▼	FLEXELEMENT 1 dt: 20	Range: 20 to 86400 in steps of 1
MESSAGE	▲▼	FLEXELEMENT 1 PKP DELAY: 0.000 s	Range: 0.000 to 65.535 s in steps of 0.001
MESSAGE	▲▼	FLEXELEMENT 1 RST DELAY: 0.000 s	Range: 0.000 to 65.535 s in steps of 0.001
MESSAGE	▲▼	FLEXELEMENT 1 BLK: Off	Range: FlexLogic™ operand
MESSAGE	▲▼	FLEXELEMENT 1 TARGET: Self-reset	Range: Self-reset, Latched, Disabled
MESSAGE	▲	FLEXELEMENT 1 EVENTS: Disabled	Range: Disabled, Enabled

A FlexElement™ is a universal comparator that can be used to monitor any analog actual value calculated by the relay or a net difference of any two analog actual values of the same type. The effective operating signal could be treated as a signed number or its absolute value could be used as per user's choice.

The element can be programmed to respond either to a signal level or to a rate-of-change (delta) over a pre-defined period of time. The output operand is asserted when the operating signal is higher than a threshold or lower than a threshold as per user's choice.

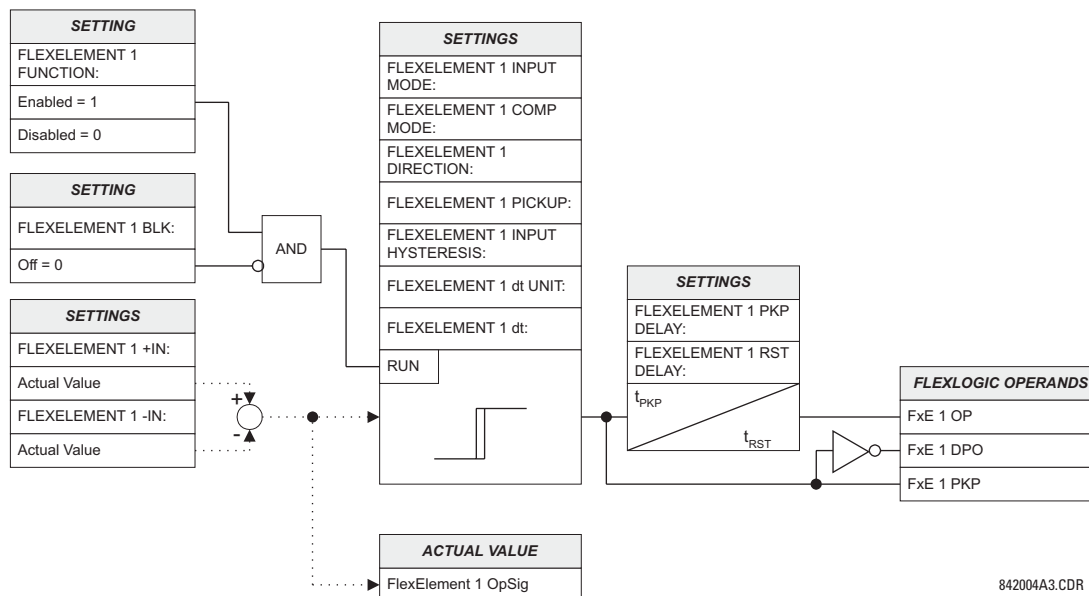

Figure 5-33: FLEXELEMENT™ SCHEME LOGIC

The **FLEXELEMENT 1 +IN** setting specifies the first (non-inverted) input to the FlexElement™. Zero is assumed as the input if this setting is set to “Off”. For proper operation of the element at least one input must be selected. Otherwise, the element will not assert its output operands.

This **FLEXELEMENT 1 –IN** setting specifies the second (inverted) input to the FlexElement™. Zero is assumed as the input if this setting is set to “Off”. For proper operation of the element at least one input must be selected. Otherwise, the element will not assert its output operands. This input should be used to invert the signal if needed for convenience, or to make the element respond to a differential signal such as for a top-bottom oil temperature differential alarm. The element will not operate if the two input signals are of different types, for example if one tries to use active power and phase angle to build the effective operating signal.

The element responds directly to the differential signal if the **FLEXELEMENT 1 INPUT MODE** setting is set to “Signed”. The element responds to the absolute value of the differential signal if this setting is set to “Absolute”. Sample applications for the “Absolute” setting include monitoring the angular difference between two phasors with a symmetrical limit angle in both directions; monitoring power regardless of its direction, or monitoring a trend regardless of whether the signal increases or decreases.

The element responds directly to its operating signal – as defined by the **FLEXELEMENT 1 +IN**, **FLEXELEMENT 1 –IN** and **FLEXELEMENT 1 INPUT MODE** settings – if the **FLEXELEMENT 1 COMP MODE** setting is set to “Threshold”. The element responds to the rate of change of its operating signal if the **FLEXELEMENT 1 COMP MODE** setting is set to “Delta”. In this case the **FLEXELEMENT 1 dt UNIT** and **FLEXELEMENT 1 dt** settings specify how the rate of change is derived.

The **FLEXELEMENT 1 DIRECTION** setting enables the relay to respond to either high or low values of the operating signal. The following figure explains the application of the **FLEXELEMENT 1 DIRECTION**, **FLEXELEMENT 1 PICKUP** and **FLEXELEMENT 1 HYSTERESIS** settings.

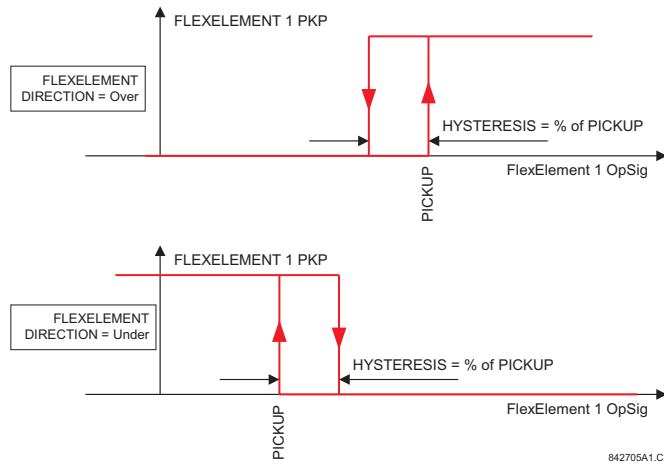

Figure 5–34: FLEXELEMENT™ DIRECTION, PICKUP, AND HYSTERESIS

In conjunction with the FLEXELEMENT 1 INPUT MODE setting the element could be programmed to provide two extra characteristics as shown in the figure below.

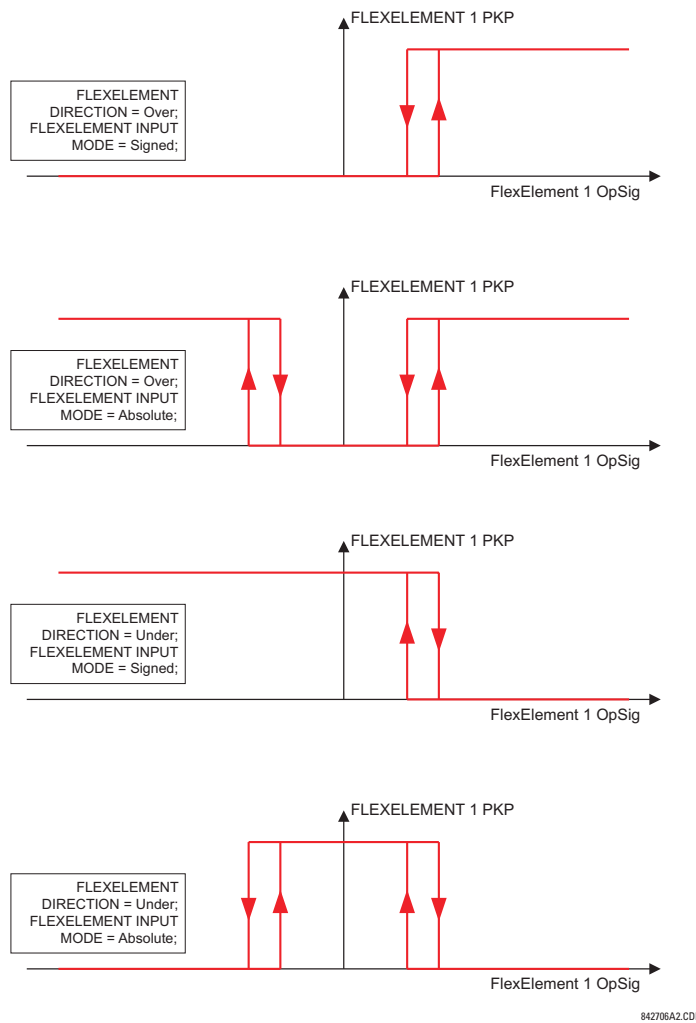

Figure 5–35: FLEXELEMENT™ INPUT MODE SETTING

The **FLEXELEMENT 1 PICKUP** setting specifies the operating threshold for the effective operating signal of the element. If set to “Over”, the element picks up when the operating signal exceeds the **FLEXELEMENT 1 PICKUP** value. If set to “Under”, the element picks up when the operating signal falls below the **FLEXELEMENT 1 PICKUP** value.

The **FLEXELEMENT 1 HYSTERESIS** setting controls the element dropout. It should be noticed that both the operating signal and the pickup threshold can be negative facilitating applications such as reverse power alarm protection. The FlexElement™ can be programmed to work with all analog actual values measured by the relay. The **FLEXELEMENT 1 PICKUP** setting is entered in per-unit values using the following definitions of the base units:

Table 5–8: FLEXELEMENT™ BASE UNITS

dcmA	BASE = maximum value of the DCMA INPUT MAX setting for the two transducers configured under the +IN and –IN inputs.
FREQUENCY	$f_{BASE} = 1 \text{ Hz}$
PHASE ANGLE	$\phi_{BASE} = 360 \text{ degrees}$ (see the UR angle referencing convention)
POWER FACTOR	$PF_{BASE} = 1.00$
RTDs	BASE = 100°C
SOURCE CURRENT	$I_{BASE} = \text{maximum nominal primary RMS value of the +IN and –IN inputs}$
SOURCE ENERGY (Positive and Negative Watthours, Positive and Negative Varhours)	$E_{BASE} = 10000 \text{ MWh or MVAh, respectively}$
SOURCE POWER	$P_{BASE} = \text{maximum value of } V_{BASE} \times I_{BASE} \text{ for the +IN and –IN inputs}$
SOURCE VOLTAGE	$V_{BASE} = \text{maximum nominal primary RMS value of the +IN and –IN inputs}$

5

The **FLEXELEMENT 1 HYSTERESIS** setting defines the pickup–dropout relation of the element by specifying the width of the hysteresis loop as a percentage of the pickup value as shown in the FlexElement™ Direction, Pickup, and Hysteresis diagram.

The **FLEXELEMENT 1 DT UNIT** setting specifies the time unit for the setting **FLEXELEMENT 1 dt**. This setting is applicable only if **FLEXELEMENT 1 COMP MODE** is set to “Delta”. The **FLEXELEMENT 1 DT** setting specifies duration of the time interval for the rate of change mode of operation. This setting is applicable only if **FLEXELEMENT 1 COMP MODE** is set to “Delta”.

This **FLEXELEMENT 1 PKP DELAY** setting specifies the pickup delay of the element. The **FLEXELEMENT 1 RST DELAY** setting specifies the reset delay of the element.

5.4.8 NON-VOLATILE LATCHES

PATH: SETTINGS ⇨ FLEXLOGIC ⇨ NON-VOLATILE LATCHES ⇨ LATCH 1(16)

<div style="border: 1px solid black; padding: 2px;"> ■ LATCH 1 ■ </div>	<div style="border: 1px solid black; padding: 2px;"> LATCH 1 FUNCTION: Disabled </div>	Range: Disabled, Enabled
MESSAGE	<div style="border: 1px solid black; padding: 2px;"> LATCH 1 TYPE: Reset Dominant </div>	Range: Reset Dominant, Set Dominant
MESSAGE	<div style="border: 1px solid black; padding: 2px;"> LATCH 1 SET: Off </div>	Range: FlexLogic™ operand
MESSAGE	<div style="border: 1px solid black; padding: 2px;"> LATCH 1 RESET: Off </div>	Range: FlexLogic™ operand
MESSAGE	<div style="border: 1px solid black; padding: 2px;"> LATCH 1 TARGET: Self-reset </div>	Range: Self-reset, Latched, Disabled
MESSAGE	<div style="border: 1px solid black; padding: 2px;"> LATCH 1 EVENTS: Disabled </div>	Range: Disabled, Enabled

The non-volatile latches provide a permanent logical flag that is stored safely and will not reset upon reboot after the relay is powered down. Typical applications include sustaining operator commands or permanently block relay functions, such as Autorecloser, until a deliberate HMI action resets the latch. The settings, logic, and element operation are described below:

- **LATCH 1 TYPE:** This setting characterizes Latch 1 to be Set- or Reset-dominant.
- **LATCH 1 SET:** If asserted, the specified FlexLogic™ operands 'sets' Latch 1.
- **LATCH 1 RESET:** If asserted, the specified FlexLogic™ operand 'resets' Latch 1.

LATCH N TYPE	LATCH N SET	LATCH N RESET	LATCH N ON	LATCH N OFF
Reset Dominant	ON	OFF	ON	OFF
	OFF	OFF	Previous State	Previous State
	ON	ON	OFF	ON
	OFF	ON	OFF	ON
Set Dominant	ON	OFF	ON	OFF
	ON	ON	ON	OFF
	OFF	OFF	Previous State	Previous State
	OFF	ON	OFF	ON

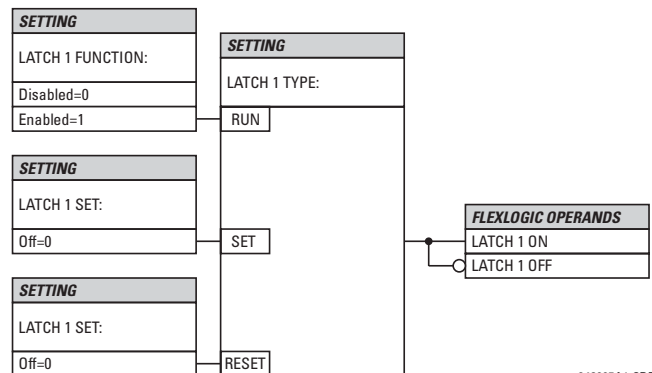

842005A1.CDR

Figure 5–36: NON-VOLATILE LATCH OPERATION TABLE (N=1 to 16) AND LOGIC

5.5.1 OVERVIEW

Each protection element can be assigned up to six different sets of settings according to Setting Group designations 1 to 6. The performance of these elements is defined by the active Setting Group at a given time. Multiple setting groups allow the user to conveniently change protection settings for different operating situations (e.g. altered power system configuration, season of the year). The active setting group can be preset or selected via the **SETTING GROUPS** menu (see the *Control Elements* section later in this chapter). See also the *Introduction to Elements* section at the beginning of this chapter.

5.5.2 SETTING GROUP

PATH: SETTINGS ↓ GROUPED ELEMENTS ⇨ SETTING GROUP 1(6)

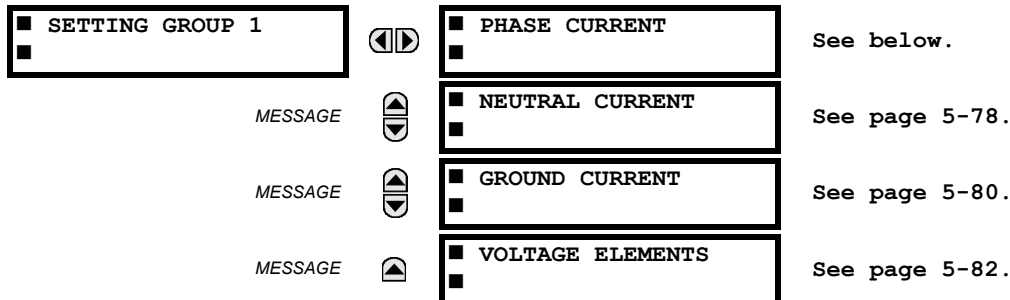

Each of the six Setting Group menus is identical. **SETTING GROUP 1** (the default active group) automatically becomes active if no other group is active (see the Control Elements section for additional details).

5

5.5.3 PHASE CURRENT

a) INVERSE TOC CURVE CHARACTERISTICS

The inverse time overcurrent curves used by the time overcurrent elements are the IEEE, IEC, GE Type IAC, and I^2t standard curve shapes. This allows for simplified coordination with downstream devices. If however, none of these curve shapes is adequate, FlexCurves™ may be used to customize the inverse time curve characteristics. The Definite Time curve is also an option that may be appropriate if only simple protection is required.

Table 5-9: OVERCURRENT CURVE TYPES

IEEE	IEC	GE TYPE IAC	OTHER
IEEE Extremely Inv.	IEC Curve A (BS142)	IAC Extremely Inv.	I^2t
IEEE Very Inverse	IEC Curve B (BS142)	IAC Very Inverse	FlexCurves™ A, B, C, and D
IEEE Moderately Inv.	IEC Curve C (BS142)	IAC Inverse	Recloser Curves
	IEC Short Inverse	IAC Short Inverse	Definite Time

A time dial multiplier setting allows selection of a multiple of the base curve shape (where the time dial multiplier = 1) with the curve shape (**CURVE**) setting. Unlike the electromechanical time dial equivalent, operate times are directly proportional to the time multiplier (**TD MULTIPLIER**) setting value. For example, all times for a multiplier of 10 are 10 times the multiplier 1 or base curve values. Setting the multiplier to zero results in an instantaneous response to all current levels above pickup.

Time overcurrent time calculations are made with an internal ‘energy capacity’ memory variable. When this variable indicates that the energy capacity has reached 100%, a time overcurrent element will operate. If less than 100% energy capacity is accumulated in this variable and the current falls below the dropout threshold of 97 to 98% of the pickup value, the variable must be reduced. Two methods of this resetting operation are available: “Instantaneous” and “Timed”. The “Instantaneous” selection is intended for applications with other relays, such as most static relays, which set the energy capacity directly to zero when the current falls below the reset threshold. The “Timed” selection can be used where the relay must coordinate with electromechanical relays.



Graphs of standard time-current curves on 11” × 17” log-log graph paper are available upon request from the GE Multilin literature department. The original files are also available in PDF format on the enerVista CD and the GE Multilin website at <http://www.GEindustrial.com/multilin>.

IEEE CURVES:

The IEEE time overcurrent curve shapes conform to industry standards and the IEEE C37.112-1996 curve classifications for extremely, very, and moderately inverse. The IEEE curves are derived from the formulae:

$$T = TDM \times \left[\frac{A}{\left(\frac{I}{I_{pickup}}\right)^p - 1} + B \right], T_{RESET} = TDM \times \left[\frac{t_r}{\left(\frac{I}{I_{pickup}}\right)^2 - 1} \right] \quad (\text{EQ 5.6})$$

where: T = operate time (in seconds), TDM = Multiplier setting, I = input current, I_{pickup} = Pickup Current setting
 A, B, p = constants, T_{RESET} = reset time in seconds (assuming energy capacity is 100% and RESET is "Timed"),
 t_r = characteristic constant

Table 5-10: IEEE INVERSE TIME CURVE CONSTANTS

IEEE CURVE SHAPE	A	B	P	T _R
IEEE Extremely Inverse	28.2	0.1217	2.0000	29.1
IEEE Very Inverse	19.61	0.491	2.0000	21.6
IEEE Moderately Inverse	0.0515	0.1140	0.02000	4.85

Table 5-11: IEEE CURVE TRIP TIMES (IN SECONDS)

MULTIPLIER (TDM)	CURRENT (I / I_{pickup})									
	1.5	2.0	3.0	4.0	5.0	6.0	7.0	8.0	9.0	10.0
IEEE EXTREMELY INVERSE										
0.5	11.341	4.761	1.823	1.001	0.648	0.464	0.355	0.285	0.237	0.203
1.0	22.682	9.522	3.647	2.002	1.297	0.927	0.709	0.569	0.474	0.407
2.0	45.363	19.043	7.293	4.003	2.593	1.855	1.418	1.139	0.948	0.813
4.0	90.727	38.087	14.587	8.007	5.187	3.710	2.837	2.277	1.897	1.626
6.0	136.090	57.130	21.880	12.010	7.780	5.564	4.255	3.416	2.845	2.439
8.0	181.454	76.174	29.174	16.014	10.374	7.419	5.674	4.555	3.794	3.252
10.0	226.817	95.217	36.467	20.017	12.967	9.274	7.092	5.693	4.742	4.065
IEEE VERY INVERSE										
0.5	8.090	3.514	1.471	0.899	0.654	0.526	0.450	0.401	0.368	0.345
1.0	16.179	7.028	2.942	1.798	1.308	1.051	0.900	0.802	0.736	0.689
2.0	32.358	14.055	5.885	3.597	2.616	2.103	1.799	1.605	1.472	1.378
4.0	64.716	28.111	11.769	7.193	5.232	4.205	3.598	3.209	2.945	2.756
6.0	97.074	42.166	17.654	10.790	7.849	6.308	5.397	4.814	4.417	4.134
8.0	129.432	56.221	23.538	14.387	10.465	8.410	7.196	6.418	5.889	5.513
10.0	161.790	70.277	29.423	17.983	13.081	10.513	8.995	8.023	7.361	6.891
IEEE MODERATELY INVERSE										
0.5	3.220	1.902	1.216	0.973	0.844	0.763	0.706	0.663	0.630	0.603
1.0	6.439	3.803	2.432	1.946	1.688	1.526	1.412	1.327	1.260	1.207
2.0	12.878	7.606	4.864	3.892	3.377	3.051	2.823	2.653	2.521	2.414
4.0	25.756	15.213	9.729	7.783	6.753	6.102	5.647	5.307	5.041	4.827
6.0	38.634	22.819	14.593	11.675	10.130	9.153	8.470	7.960	7.562	7.241
8.0	51.512	30.426	19.458	15.567	13.507	12.204	11.294	10.614	10.083	9.654
10.0	64.390	38.032	24.322	19.458	16.883	15.255	14.117	13.267	12.604	12.068

IEC CURVES

For European applications, the relay offers three standard curves defined in IEC 255-4 and British standard BS142. These are defined as IEC Curve A, IEC Curve B, and IEC Curve C. The formulae for these curves are:

$$T = TDM \times \left[\frac{K}{(I/I_{pickup})^E - 1} \right], T_{RESET} = TDM \times \left[\frac{t_r}{(I/I_{pickup})^2 - 1} \right] \quad (\text{EQ 5.7})$$

where: T = operate time (in seconds), TDM = Multiplier setting, I = input current, I_{pickup} = Pickup Current setting, K , E = constants, t_r = characteristic constant, and T_{RESET} = reset time in seconds (assuming energy capacity is 100% and RESET is "Timed")

Table 5–12: IEC (BS) INVERSE TIME CURVE CONSTANTS

IEC (BS) CURVE SHAPE	K	E	T _R
IEC Curve A (BS142)	0.140	0.020	9.7
IEC Curve B (BS142)	13.500	1.000	43.2
IEC Curve C (BS142)	80.000	2.000	58.2
IEC Short Inverse	0.050	0.040	0.500

Table 5–13: IEC CURVE TRIP TIMES (IN SECONDS)

MULTIPLIER (TDM)	CURRENT (I / I _{pickup})									
	1.5	2.0	3.0	4.0	5.0	6.0	7.0	8.0	9.0	10.0
IEC CURVE A										
0.05	0.860	0.501	0.315	0.249	0.214	0.192	0.176	0.165	0.156	0.149
0.10	1.719	1.003	0.630	0.498	0.428	0.384	0.353	0.330	0.312	0.297
0.20	3.439	2.006	1.260	0.996	0.856	0.767	0.706	0.659	0.623	0.594
0.40	6.878	4.012	2.521	1.992	1.712	1.535	1.411	1.319	1.247	1.188
0.60	10.317	6.017	3.781	2.988	2.568	2.302	2.117	1.978	1.870	1.782
0.80	13.755	8.023	5.042	3.984	3.424	3.070	2.822	2.637	2.493	2.376
1.00	17.194	10.029	6.302	4.980	4.280	3.837	3.528	3.297	3.116	2.971
IEC CURVE B										
0.05	1.350	0.675	0.338	0.225	0.169	0.135	0.113	0.096	0.084	0.075
0.10	2.700	1.350	0.675	0.450	0.338	0.270	0.225	0.193	0.169	0.150
0.20	5.400	2.700	1.350	0.900	0.675	0.540	0.450	0.386	0.338	0.300
0.40	10.800	5.400	2.700	1.800	1.350	1.080	0.900	0.771	0.675	0.600
0.60	16.200	8.100	4.050	2.700	2.025	1.620	1.350	1.157	1.013	0.900
0.80	21.600	10.800	5.400	3.600	2.700	2.160	1.800	1.543	1.350	1.200
1.00	27.000	13.500	6.750	4.500	3.375	2.700	2.250	1.929	1.688	1.500
IEC CURVE C										
0.05	3.200	1.333	0.500	0.267	0.167	0.114	0.083	0.063	0.050	0.040
0.10	6.400	2.667	1.000	0.533	0.333	0.229	0.167	0.127	0.100	0.081
0.20	12.800	5.333	2.000	1.067	0.667	0.457	0.333	0.254	0.200	0.162
0.40	25.600	10.667	4.000	2.133	1.333	0.914	0.667	0.508	0.400	0.323
0.60	38.400	16.000	6.000	3.200	2.000	1.371	1.000	0.762	0.600	0.485
0.80	51.200	21.333	8.000	4.267	2.667	1.829	1.333	1.016	0.800	0.646
1.00	64.000	26.667	10.000	5.333	3.333	2.286	1.667	1.270	1.000	0.808
IEC SHORT TIME										
0.05	0.153	0.089	0.056	0.044	0.038	0.034	0.031	0.029	0.027	0.026
0.10	0.306	0.178	0.111	0.088	0.075	0.067	0.062	0.058	0.054	0.052
0.20	0.612	0.356	0.223	0.175	0.150	0.135	0.124	0.115	0.109	0.104
0.40	1.223	0.711	0.445	0.351	0.301	0.269	0.247	0.231	0.218	0.207
0.60	1.835	1.067	0.668	0.526	0.451	0.404	0.371	0.346	0.327	0.311
0.80	2.446	1.423	0.890	0.702	0.602	0.538	0.494	0.461	0.435	0.415
1.00	3.058	1.778	1.113	0.877	0.752	0.673	0.618	0.576	0.544	0.518

IAC CURVES:

The curves for the General Electric type IAC relay family are derived from the formulae:

$$T = TDM \times \left(A + \frac{B}{(I/I_{pkp}) - C} + \frac{D}{((I/I_{pkp}) - C)^2} + \frac{E}{((I/I_{pkp}) - C)^3} \right), T_{RESET} = TDM \times \left[\frac{t_r}{(I/I_{pkp})^2 - 1} \right] \quad \text{(EQ 5.8)}$$

where: T = operate time (in seconds), TDM = Multiplier setting, I = Input current, I_{pkp} = Pickup Current setting, A to E = constants, t_r = characteristic constant, and T_{RESET} = reset time in seconds (assuming energy capacity is 100% and RESET is "Timed")

Table 5-14: GE TYPE IAC INVERSE TIME CURVE CONSTANTS

IAC CURVE SHAPE	A	B	C	D	E	T _R
IAC Extreme Inverse	0.0040	0.6379	0.6200	1.7872	0.2461	6.008
IAC Very Inverse	0.0900	0.7955	0.1000	-1.2885	7.9586	4.678
IAC Inverse	0.2078	0.8630	0.8000	-0.4180	0.1947	0.990
IAC Short Inverse	0.0428	0.0609	0.6200	-0.0010	0.0221	0.222

Table 5-15: IAC CURVE TRIP TIMES

MULTIPLIER (TDM)	CURRENT (I / I _{pickup})									
	1.5	2.0	3.0	4.0	5.0	6.0	7.0	8.0	9.0	10.0
IAC EXTREMELY INVERSE										
0.5	1.699	0.749	0.303	0.178	0.123	0.093	0.074	0.062	0.053	0.046
1.0	3.398	1.498	0.606	0.356	0.246	0.186	0.149	0.124	0.106	0.093
2.0	6.796	2.997	1.212	0.711	0.491	0.372	0.298	0.248	0.212	0.185
4.0	13.591	5.993	2.423	1.422	0.983	0.744	0.595	0.495	0.424	0.370
6.0	20.387	8.990	3.635	2.133	1.474	1.115	0.893	0.743	0.636	0.556
8.0	27.183	11.987	4.846	2.844	1.966	1.487	1.191	0.991	0.848	0.741
10.0	33.979	14.983	6.058	3.555	2.457	1.859	1.488	1.239	1.060	0.926
IAC VERY INVERSE										
0.5	1.451	0.656	0.269	0.172	0.133	0.113	0.101	0.093	0.087	0.083
1.0	2.901	1.312	0.537	0.343	0.266	0.227	0.202	0.186	0.174	0.165
2.0	5.802	2.624	1.075	0.687	0.533	0.453	0.405	0.372	0.349	0.331
4.0	11.605	5.248	2.150	1.374	1.065	0.906	0.810	0.745	0.698	0.662
6.0	17.407	7.872	3.225	2.061	1.598	1.359	1.215	1.117	1.046	0.992
8.0	23.209	10.497	4.299	2.747	2.131	1.813	1.620	1.490	1.395	1.323
10.0	29.012	13.121	5.374	3.434	2.663	2.266	2.025	1.862	1.744	1.654
IAC INVERSE										
0.5	0.578	0.375	0.266	0.221	0.196	0.180	0.168	0.160	0.154	0.148
1.0	1.155	0.749	0.532	0.443	0.392	0.360	0.337	0.320	0.307	0.297
2.0	2.310	1.499	1.064	0.885	0.784	0.719	0.674	0.640	0.614	0.594
4.0	4.621	2.997	2.128	1.770	1.569	1.439	1.348	1.280	1.229	1.188
6.0	6.931	4.496	3.192	2.656	2.353	2.158	2.022	1.921	1.843	1.781
8.0	9.242	5.995	4.256	3.541	3.138	2.878	2.695	2.561	2.457	2.375
10.0	11.552	7.494	5.320	4.426	3.922	3.597	3.369	3.201	3.072	2.969
IAC SHORT INVERSE										
0.5	0.072	0.047	0.035	0.031	0.028	0.027	0.026	0.026	0.025	0.025
1.0	0.143	0.095	0.070	0.061	0.057	0.054	0.052	0.051	0.050	0.049
2.0	0.286	0.190	0.140	0.123	0.114	0.108	0.105	0.102	0.100	0.099
4.0	0.573	0.379	0.279	0.245	0.228	0.217	0.210	0.204	0.200	0.197
6.0	0.859	0.569	0.419	0.368	0.341	0.325	0.314	0.307	0.301	0.296
8.0	1.145	0.759	0.559	0.490	0.455	0.434	0.419	0.409	0.401	0.394
10.0	1.431	0.948	0.699	0.613	0.569	0.542	0.524	0.511	0.501	0.493

I²t CURVES:

The curves for the I²t are derived from the formulae:

$$T = \text{TDM} \times \left[\frac{100}{\left(\frac{I}{I_{pickup}}\right)^2} \right], T_{RESET} = \text{TDM} \times \left[\frac{100}{\left(\frac{I}{I_{pickup}}\right)^{-2}} \right] \quad (\text{EQ 5.9})$$

where: T = Operate Time (sec.); TDM = Multiplier Setting; I = Input Current; I_{pickup} = Pickup Current Setting;
 T_{RESET} = Reset Time in sec. (assuming energy capacity is 100% and RESET: Timed)

Table 5–16: I²T CURVE TRIP TIMES

MULTIPLIER (TDM)	CURRENT (I / I_{pickup})									
	1.5	2.0	3.0	4.0	5.0	6.0	7.0	8.0	9.0	10.0
0.01	0.44	0.25	0.11	0.06	0.04	0.03	0.02	0.02	0.01	0.01
0.10	4.44	2.50	1.11	0.63	0.40	0.28	0.20	0.16	0.12	0.10
1.00	44.44	25.00	11.11	6.25	4.00	2.78	2.04	1.56	1.23	1.00
10.00	444.44	250.00	111.11	62.50	40.00	27.78	20.41	15.63	12.35	10.00
100.00	4444.4	2500.0	1111.1	625.00	400.00	277.78	204.08	156.25	123.46	100.00
600.00	26666.7	15000.0	6666.7	3750.0	2400.0	1666.7	1224.5	937.50	740.74	600.00

FLEXCURVES™:

The custom FlexCurves™ are described in detail in the FlexCurves™ section of this chapter. The curve shapes for the FlexCurves™ are derived from the formulae:

$$T = \text{TDM} \times \left[\text{FlexCurve Time at } \left(\frac{I}{I_{pickup}}\right) \right] \quad \text{when } \left(\frac{I}{I_{pickup}}\right) \geq 1.00 \quad (\text{EQ 5.10})$$

$$T_{RESET} = \text{TDM} \times \left[\text{FlexCurve Time at } \left(\frac{I}{I_{pickup}}\right) \right] \quad \text{when } \left(\frac{I}{I_{pickup}}\right) \leq 0.98 \quad (\text{EQ 5.11})$$

where: T = Operate Time (sec.), TDM = Multiplier setting
 I = Input Current, I_{pickup} = Pickup Current setting
 T_{RESET} = Reset Time in seconds (assuming energy capacity is 100% and RESET: Timed)

DEFINITE TIME CURVE:

The Definite Time curve shape operates as soon as the pickup level is exceeded for a specified period of time. The base definite time curve delay is in seconds. The curve multiplier of 0.00 to 600.00 makes this delay adjustable from instantaneous to 600.00 seconds in steps of 10 ms.

$$T = \text{TDM} \quad \text{in seconds, when } I > I_{pickup} \quad (\text{EQ 5.12})$$

$$T_{RESET} = -\text{TDM} \quad \text{in seconds} \quad (\text{EQ 5.13})$$

where: T = Operate Time (sec.), TDM = Multiplier setting
 I = Input Current, I_{pickup} = Pickup Current setting
 T_{RESET} = Reset Time in seconds (assuming energy capacity is 100% and RESET: Timed)

RECLOSER CURVES:

The F35 uses the FlexCurve™ feature to facilitate programming of 41 recloser curves. Please refer to the FlexCurve™ section in this chapter for additional details.

b) PHASE TIME OVERCURRENT (ANSI 51P)

PATH: SETTINGS ⇒ ↓ GROUPED ELEMENTS ⇒ SETTING GROUP 1(6) ⇒ PHASE CURRENT ⇒ PHASE TOC1(6)

■ PHASE TOC1	◀▶	PHASE TOC1 FUNCTION: Disabled	Range: Disabled, Enabled
MESSAGE	▲▼	PHASE TOC1 SIGNAL SOURCE: SRC 1	Range: SRC 1, SRC 2, SRC 3, SRC 4, SRC 5, SRC 6
MESSAGE	▲▼	PHASE TOC1 INPUT: Phasor	Range: Phasor, RMS
MESSAGE	▲▼	PHASE TOC1 PICKUP: 1.000 pu	Range: 0.000 to 30.000 pu in steps of 0.001
MESSAGE	▲▼	PHASE TOC1 CURVE: IEEE Mod Inv	Range: See Overcurrent Curve Types table
MESSAGE	▲▼	PHASE TOC1 TD MULTIPLIER: 1.00	Range: 0.00 to 600.00 in steps of 0.01
MESSAGE	▲▼	PHASE TOC1 RESET: Instantaneous	Range: Instantaneous, Timed
MESSAGE	▲▼	PHASE TOC1 VOLTAGE RESTRAINT: Disabled	Range: Disabled, Enabled
MESSAGE	▲▼	PHASE TOC1 BLOCK A: Off	Range: FlexLogic™ operand
MESSAGE	▲▼	PHASE TOC1 BLOCK B: Off	Range: FlexLogic™ operand
MESSAGE	▲▼	PHASE TOC1 BLOCK C: Off	Range: FlexLogic™ operand
MESSAGE	▲▼	PHASE TOC1 TARGET: Self-reset	Range: Self-reset, Latched, Disabled
MESSAGE	▲	PHASE TOC1 EVENTS: Disabled	Range: Disabled, Enabled

The phase time overcurrent element can provide a desired time-delay operating characteristic versus the applied current or be used as a simple Definite Time element. The phase current input quantities may be programmed as fundamental phasor magnitude or total waveform RMS magnitude as required by the application.

Two methods of resetting operation are available: “Timed” and “Instantaneous” (refer to the *Inverse TOC Curves Characteristic* sub-section earlier for details on curve setup, trip times and reset operation). When the element is blocked, the time accumulator will reset according to the reset characteristic. For example, if the element reset characteristic is set to “Instantaneous” and the element is blocked, the time accumulator will be cleared immediately.

The **PHASE TOC1 PICKUP** setting can be dynamically reduced by a voltage restraint feature (when enabled). This is accomplished via the multipliers (Mvr) corresponding to the phase-phase voltages of the voltage restraint characteristic curve (see the figure below); the pickup level is calculated as ‘Mvr’ times the **PHASE TOC1 PICKUP** setting. If the voltage restraint feature is disabled, the pickup level always remains at the setting value.

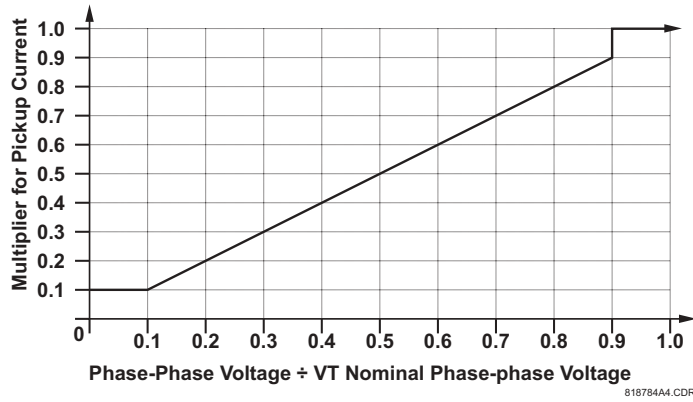

Figure 5-37: PHASE TOC VOLTAGE RESTRAINT CHARACTERISTIC

5

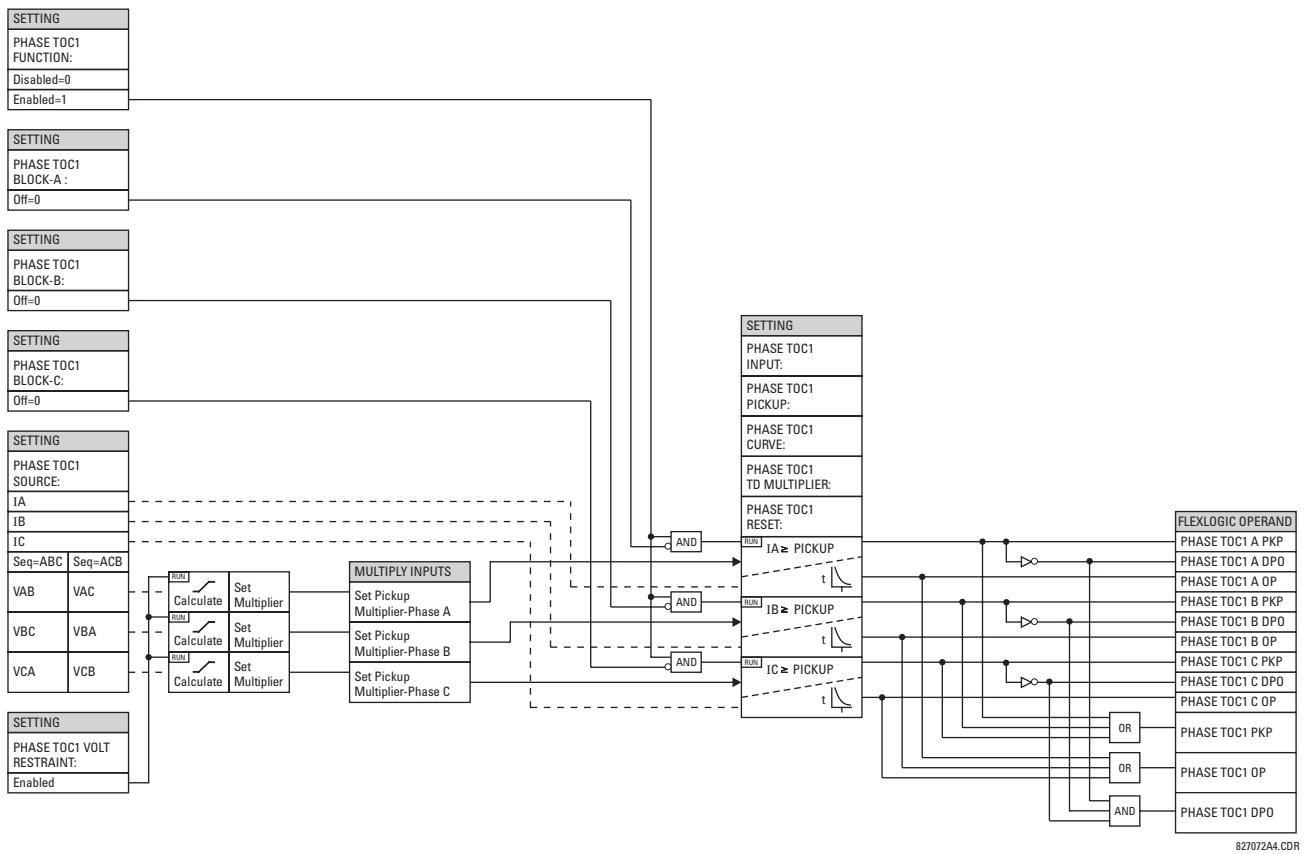

Figure 5-38: PHASE TOC1 SCHEME LOGIC

c) PHASE INSTANTANEOUS OVERCURRENT (ANSI 50P)

PATH: SETTINGS ⇨ GROUPED ELEMENTS ⇨ SETTING GROUP 1(6) ⇨ PHASE CURRENT ⇨ PHASE IOC 1(12)

<div style="border: 1px solid black; padding: 2px;"> ■ PHASE IOC1 ■ </div>	<div style="border: 1px solid black; padding: 2px;"> PHASE IOC1 FUNCTION: Disabled </div>	Range: Disabled, Enabled
MESSAGE	<div style="border: 1px solid black; padding: 2px;"> PHASE IOC1 SIGNAL SOURCE: SRC 1 </div>	Range: SRC 1, SRC 2, SRC 3, SRC 4, SRC 5, SRC 6
MESSAGE	<div style="border: 1px solid black; padding: 2px;"> PHASE IOC1 PICKUP: 1.000 pu </div>	Range: 0.000 to 30.000 pu in steps of 0.001
MESSAGE	<div style="border: 1px solid black; padding: 2px;"> PHASE IOC1 PICKUP DELAY: 0.00 s </div>	Range: 0.00 to 600.00 s in steps of 0.01
MESSAGE	<div style="border: 1px solid black; padding: 2px;"> PHASE IOC1 RESET DELAY: 0.00 s </div>	Range: 0.00 to 600.00 s in steps of 0.01
MESSAGE	<div style="border: 1px solid black; padding: 2px;"> PHASE IOC1 BLOCK A: Off </div>	Range: FlexLogic™ operand
MESSAGE	<div style="border: 1px solid black; padding: 2px;"> PHASE IOC1 BLOCK B: Off </div>	Range: FlexLogic™ operand
MESSAGE	<div style="border: 1px solid black; padding: 2px;"> PHASE IOC1 BLOCK C: Off </div>	Range: FlexLogic™ operand
MESSAGE	<div style="border: 1px solid black; padding: 2px;"> PHASE IOC1 TARGET: Self-reset </div>	Range: Self-reset, Latched, Disabled
MESSAGE	<div style="border: 1px solid black; padding: 2px;"> PHASE IOC1 EVENTS: Disabled </div>	Range: Disabled, Enabled

The phase instantaneous overcurrent element may be used as an instantaneous element with no intentional delay or as a Definite Time element. The input current is the fundamental phasor magnitude.

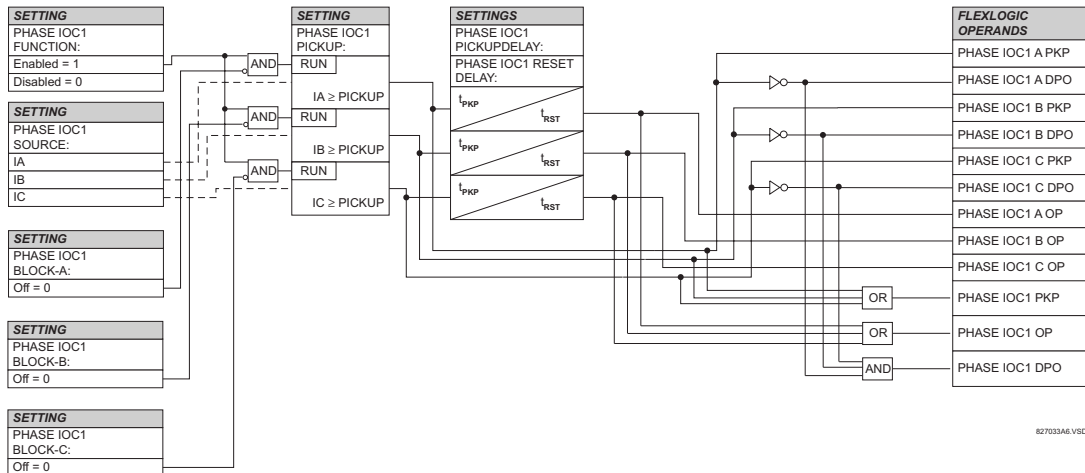

Figure 5-39: PHASE IOC1 SCHEME LOGIC

5.5.4 NEUTRAL CURRENT

a) NEUTRAL TIME OVERCURRENT (ANSI 51N)

PATH: SETTINGS ⇌ GROUPED ELEMENTS ⇌ SETTING GROUP 1(6) ⇌ NEUTRAL CURRENT ⇌ NEUTRAL TOC1(6)

■ NEUTRAL TOC1	◀▶	NEUTRAL TOC1 FUNCTION: Disabled	Range: Disabled, Enabled
MESSAGE	▲▼	NEUTRAL TOC1 SIGNAL SOURCE: SRC 1	Range: SRC 1, SRC 2, SRC 3, SRC 4, SRC 5, SRC 6
MESSAGE	▲▼	NEUTRAL TOC1 INPUT: Phasor	Range: Phasor, RMS
MESSAGE	▲▼	NEUTRAL TOC1 PICKUP: 1.000 pu	Range: 0.000 to 30.000 pu in steps of 0.001
MESSAGE	▲▼	NEUTRAL TOC1 CURVE: IEEE Mod Inv	Range: See OVERCURRENT CURVE TYPES table
MESSAGE	▲▼	NEUTRAL TOC1 TD MULTIPLIER: 1.00	Range: 0.00 to 600.00 in steps of 0.01
MESSAGE	▲▼	NEUTRAL TOC1 RESET: Instantaneous	Range: Instantaneous, Timed
MESSAGE	▲▼	NEUTRAL TOC1 BLOCK: Off	Range: FlexLogic™ operand
MESSAGE	▲▼	NEUTRAL TOC1 TARGET: Self-reset	Range: Self-reset, Latched, Disabled
MESSAGE	▲	NEUTRAL TOC1 EVENTS: Disabled	Range: Disabled, Enabled

5

The Neutral Time Overcurrent element can provide a desired time-delay operating characteristic versus the applied current or be used as a simple Definite Time element. The neutral current input value is a quantity calculated as 3I₀ from the phase currents and may be programmed as fundamental phasor magnitude or total waveform RMS magnitude as required by the application.

Two methods of resetting operation are available: “Timed” and “Instantaneous” (refer to the *Inverse TOC Curve Characteristics* section for details on curve setup, trip times and reset operation). When the element is blocked, the time accumulator will reset according to the reset characteristic. For example, if the element reset characteristic is set to “Instantaneous” and the element is blocked, the time accumulator will be cleared immediately.

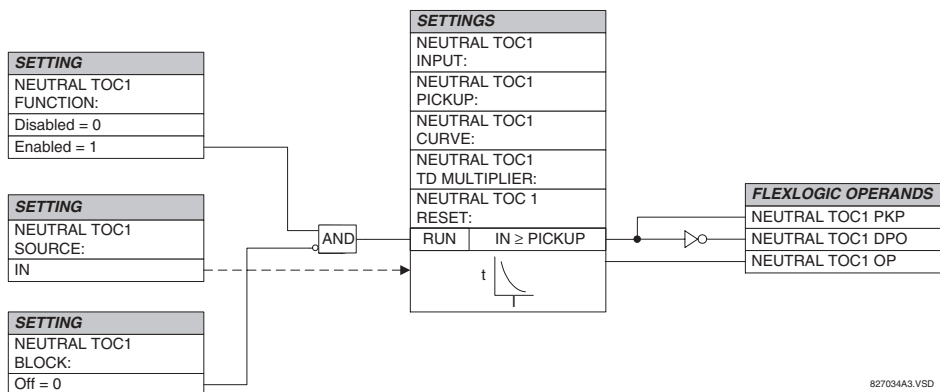

Figure 5-40: NEUTRAL TOC1 SCHEME LOGIC

b) NEUTRAL INSTANTANEOUS OVERCURRENT (ANSI 50N)

PATH: SETTINGS ⇒ GROUPED ELEMENTS ⇒ SETTING GROUP 1(6) ⇒ NEUTRAL CURRENT ⇒ NEUTRAL IOC1(12)

■ NEUTRAL IOC1	◀▶	NEUTRAL IOC1 FUNCTION: Disabled	Range: Disabled, Enabled
MESSAGE	▲▼	NEUTRAL IOC1 SIGNAL SOURCE: SRC 1	Range: SRC 1, SRC 2, SRC 3, SRC 4, SRC 5, SRC 6
MESSAGE	▲▼	NEUTRAL IOC1 PICKUP: 1.000 pu	Range: 0.000 to 30.000 pu in steps of 0.001
MESSAGE	▲▼	NEUTRAL IOC1 PICKUP DELAY: 0.00 s	Range: 0.00 to 600.00 s in steps of 0.01
MESSAGE	▲▼	NEUTRAL IOC1 RESET DELAY: 0.00 s	Range: 0.00 to 600.00 s in steps of 0.01
MESSAGE	▲▼	NEUTRAL IOC1 BLOCK: Off	Range: FlexLogic™ operand
MESSAGE	▲▼	NEUTRAL IOC1 TARGET: Self-reset	Range: Self-reset, Latched, Disabled
MESSAGE	▲	NEUTRAL IOC1 EVENTS: Disabled	Range: Disabled, Enabled

The Neutral Instantaneous Overcurrent element may be used as an instantaneous function with no intentional delay or as a Definite Time function. The element essentially responds to the magnitude of a neutral current fundamental frequency phasor calculated from the phase currents. A “positive-sequence restraint” is applied for better performance. A small portion (6.25%) of the positive-sequence current magnitude is subtracted from the zero-sequence current magnitude when forming the operating quantity of the element as follows:

$$I_{op} = 3 \times (|I_0| - K \cdot |I_1|) \quad \text{where } K = 1/16 \quad \text{(EQ 5.14)}$$

The positive-sequence restraint allows for more sensitive settings by counterbalancing spurious zero-sequence currents resulting from:

- system unbalances under heavy load conditions
- transformation errors of current transformers (CTs) during double-line and three-phase faults
- switch-off transients during double-line and three-phase faults

The positive-sequence restraint must be considered when testing for pickup accuracy and response time (multiple of pickup). The operating quantity depends on how test currents are injected into the relay (single-phase injection: $I_{op} = 0.9375 \cdot I_{injected}$; three-phase pure zero-sequence injection: $I_{op} = 3 \times I_{injected}$).

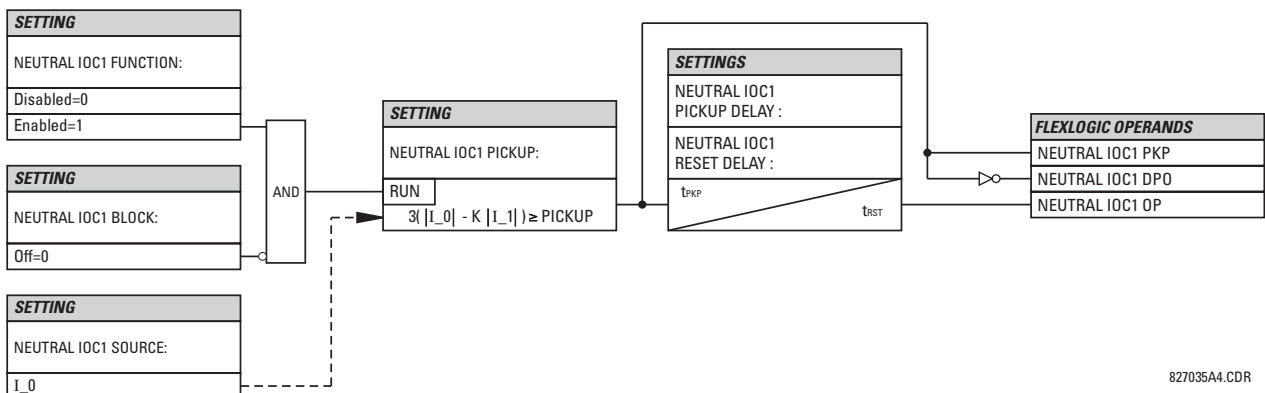

Figure 5-41: NEUTRAL IOC1 SCHEME LOGIC

5.5.5 GROUND CURRENT

a) GROUND TIME OVERCURRENT (ANSI 51G)

PATH: SETTINGS ⇨ ↓ GROUPED ELEMENTS ⇨ SETTING GROUP 1(6) ⇨ ↓ GROUND CURRENT ⇨ GROUND TOC1(6)

■ GROUND TOC1	◀▶	GROUND TOC1 FUNCTION: Disabled	Range: Disabled, Enabled
MESSAGE	▲▼	GROUND TOC1 SIGNAL SOURCE: SRC 1	Range: SRC 1, SRC 2, SRC 3, SRC 4, SRC 5, SRC 6
MESSAGE	▲▼	GROUND TOC1 INPUT: Phasor	Range: Phasor, RMS
MESSAGE	▲▼	GROUND TOC1 PICKUP: 1.000 pu	Range: 0.000 to 30.000 pu in steps of 0.001
MESSAGE	▲▼	GROUND TOC1 CURVE: IEEE Mod Inv	Range: see the Overcurrent Curve Types table
MESSAGE	▲▼	GROUND TOC1 TD MULTIPLIER: 1.00	Range: 0.00 to 600.00 in steps of 0.01
MESSAGE	▲▼	GROUND TOC1 RESET: Instantaneous	Range: Instantaneous, Timed
MESSAGE	▲▼	GROUND TOC1 BLOCK: Off	Range: FlexLogic™ operand
MESSAGE	▲▼	GROUND TOC1 TARGET: Self-reset	Range: Self-reset, Latched, Disabled
MESSAGE	▲	GROUND TOC1 EVENTS: Disabled	Range: Disabled, Enabled

5

This element can provide a desired time-delay operating characteristic versus the applied current or be used as a simple Definite Time element. The ground current input value is the quantity measured by the ground input CT and is the fundamental phasor or RMS magnitude. Two methods of resetting operation are available; “Timed” and “Instantaneous” (refer to the *Inverse Time Overcurrent Curve Characteristics* section for details). When the element is blocked, the time accumulator will reset according to the reset characteristic. For example, if the element reset characteristic is set to “Instantaneous” and the element is blocked, the time accumulator will be cleared immediately.



These elements measure the current that is connected to the ground channel of a CT/VT module. This channel may be equipped with a standard or sensitive input. The conversion range of a standard channel is from 0.02 to 46 times the CT rating. The conversion range of a sensitive channel is from 0.002 to 4.6 times the CT rating.

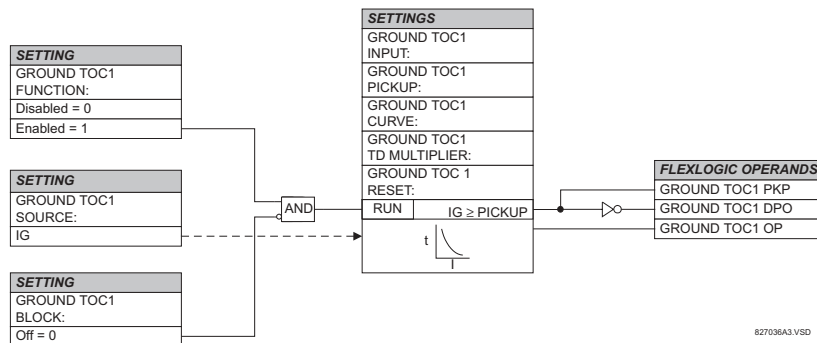

Figure 5-42: GROUND TOC1 SCHEME LOGIC

b) GROUND INSTANTANEOUS OVERCURRENT (ANSI 50G)

PATH: SETTINGS ⇒ GROUPED ELEMENTS ⇒ SETTING GROUP 1(6) ⇒ GROUND CURRENT ⇒ GROUND IOC1(12)

<div style="border: 1px solid black; padding: 2px;"> ■ GROUND IOC1 ■ </div>	<div style="border: 1px solid black; padding: 2px;"> GROUND IOC1 FUNCTION: Disabled </div>	Range: Disabled, Enabled
MESSAGE	<div style="border: 1px solid black; padding: 2px;"> GROUND IOC1 SIGNAL SOURCE: SRC 1 </div>	Range: SRC 1, SRC 2, SRC 3, SRC 4, SRC 5, SRC 6
MESSAGE	<div style="border: 1px solid black; padding: 2px;"> GROUND IOC1 PICKUP: 1.000 pu </div>	Range: 0.000 to 30.000 pu in steps of 0.001
MESSAGE	<div style="border: 1px solid black; padding: 2px;"> GROUND IOC1 PICKUP DELAY: 0.00 s </div>	Range: 0.00 to 600.00 s in steps of 0.01
MESSAGE	<div style="border: 1px solid black; padding: 2px;"> GROUND IOC1 RESET DELAY: 0.00 s </div>	Range: 0.00 to 600.00 s in steps of 0.01
MESSAGE	<div style="border: 1px solid black; padding: 2px;"> GROUND IOC1 BLOCK: Off </div>	Range: FlexLogic™ operand
MESSAGE	<div style="border: 1px solid black; padding: 2px;"> GROUND IOC1 TARGET: Self-reset </div>	Range: Self-reset, Latched, Disabled
MESSAGE	<div style="border: 1px solid black; padding: 2px;"> GROUND IOC1 EVENTS: Disabled </div>	Range: Disabled, Enabled

The Ground Instantaneous Overcurrent element may be used as an instantaneous element with no intentional delay or as a Definite Time element. The ground current input is the quantity measured by the ground input CT and is the fundamental phasor magnitude.

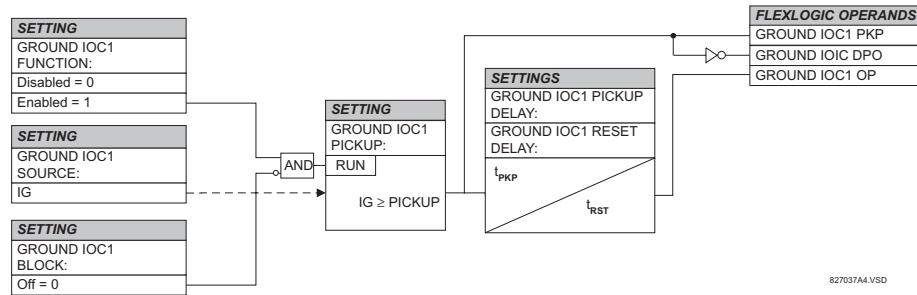

Figure 5-43: GROUND IOC1 SCHEME LOGIC



These elements measure the current that is connected to the ground channel of a CT/VT module. This channel may be equipped with a standard or sensitive input. The conversion range of a standard channel is from 0.02 to 46 times the CT rating. The conversion range of a sensitive channel is from 0.002 to 4.6 times the CT rating.

a) MAIN MENU

PATH: SETTINGS ⇄ GROUPED ELEMENTS ⇄ SETTING GROUP 1(6) ⇄ VOLTAGE ELEMENTS

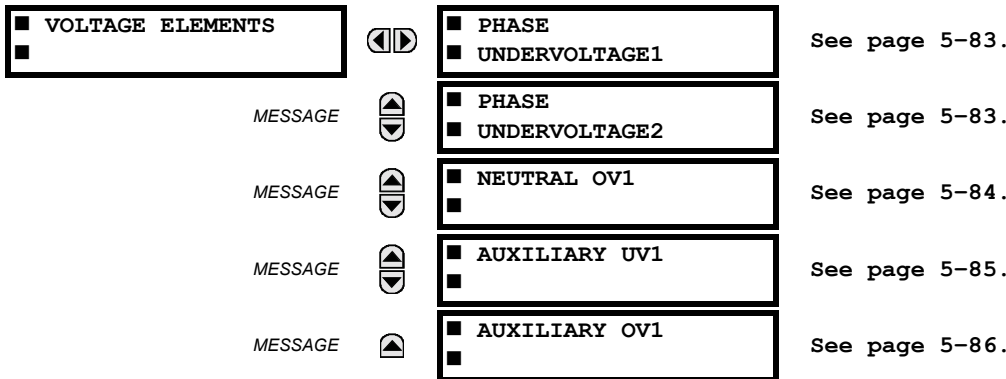

These protection elements can be used for a variety of applications such as:

Undervoltage Protection: For voltage sensitive loads, such as induction motors, a drop in voltage increases the drawn current which may cause dangerous overheating in the motor. The undervoltage protection feature can be used to either cause a trip or generate an alarm when the voltage drops below a specified voltage setting for a specified time delay.

Permissive Functions: The undervoltage feature may be used to block the functioning of external devices by operating an output relay when the voltage falls below the specified voltage setting. The undervoltage feature may also be used to block the functioning of other elements through the block feature of those elements.

Source Transfer Schemes: In the event of an undervoltage, a transfer signal may be generated to transfer a load from its normal source to a standby or emergency power source.

The undervoltage elements can be programmed to have a Definite Time delay characteristic. The Definite Time curve operates when the voltage drops below the pickup level for a specified period of time. The time delay is adjustable from 0 to 600.00 seconds in steps of 10 ms. The undervoltage elements can also be programmed to have an inverse time delay characteristic. The undervoltage delay setting defines the family of curves shown below.

$$T = \frac{D}{\left(1 - \frac{V}{V_{pickup}}\right)}$$

where: *T* = Operating Time
D = Undervoltage Delay Setting
 (*D* = 0.00 operates instantaneously)
V = Secondary Voltage applied to the relay
V_{pickup} = Pickup Level



At 0% of pickup, the operating time equals the UNDERVOLTAGE DELAY setting.

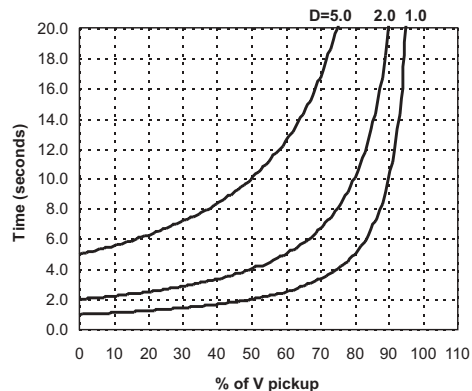

Figure 5-44: INVERSE TIME UNDERVOLTAGE CURVES

b) PHASE UNDERVOLTAGE (ANSI 27P)

PATH: SETTINGS ⇒ GROUPED ELEMENTS ⇒ SETTING GROUP 1(6) ⇒ VOLTAGE ELEMENTS ⇒ PHASE UNDERVOLTAGE1(2)

<ul style="list-style-type: none"> ■ PHASE ■ UNDERVOLTAGE1 	<div style="border: 1px solid black; padding: 2px;"> PHASE UV1 FUNCTION: Disabled </div>	Range: Disabled, Enabled
MESSAGE	<div style="border: 1px solid black; padding: 2px;"> PHASE UV1 SIGNAL SOURCE: SRC 1 </div>	Range: SRC 1, SRC 2, SRC 3, SRC 4, SRC 5, SRC 6
MESSAGE	<div style="border: 1px solid black; padding: 2px;"> PHASE UV1 MODE: Phase to Ground </div>	Range: Phase to Ground, Phase to Phase
MESSAGE	<div style="border: 1px solid black; padding: 2px;"> PHASE UV1 PICKUP: 1.000 pu </div>	Range: 0.000 to 3.000 pu in steps of 0.001
MESSAGE	<div style="border: 1px solid black; padding: 2px;"> PHASE UV1 CURVE: Definite Time </div>	Range: Definite Time, Inverse Time
MESSAGE	<div style="border: 1px solid black; padding: 2px;"> PHASE UV1 DELAY: 1.00 s </div>	Range: 0.00 to 600.00 s in steps of 0.01
MESSAGE	<div style="border: 1px solid black; padding: 2px;"> PHASE UV1 MINIMUM VOLTAGE: 0.100 pu </div>	Range: 0.000 to 3.000 pu in steps of 0.001
MESSAGE	<div style="border: 1px solid black; padding: 2px;"> PHASE UV1 BLOCK: Off </div>	Range: FlexLogic™ operand
MESSAGE	<div style="border: 1px solid black; padding: 2px;"> PHASE UV1 TARGET: Self-reset </div>	Range: Self-reset, Latched, Disabled
MESSAGE	<div style="border: 1px solid black; padding: 2px;"> PHASE UV1 EVENTS: Disabled </div>	Range: Disabled, Enabled

This element may be used to give a desired time-delay operating characteristic versus the applied fundamental voltage (phase-to-ground or phase-to-phase for Wye VT connection, or phase-to-phase for Delta VT connection) or as a Definite Time element. The element resets instantaneously if the applied voltage exceeds the dropout voltage. The delay setting selects the minimum operating time of the phase undervoltage. The minimum voltage setting selects the operating voltage below which the element is blocked (a setting of "0" will allow a dead source to be considered a fault condition).

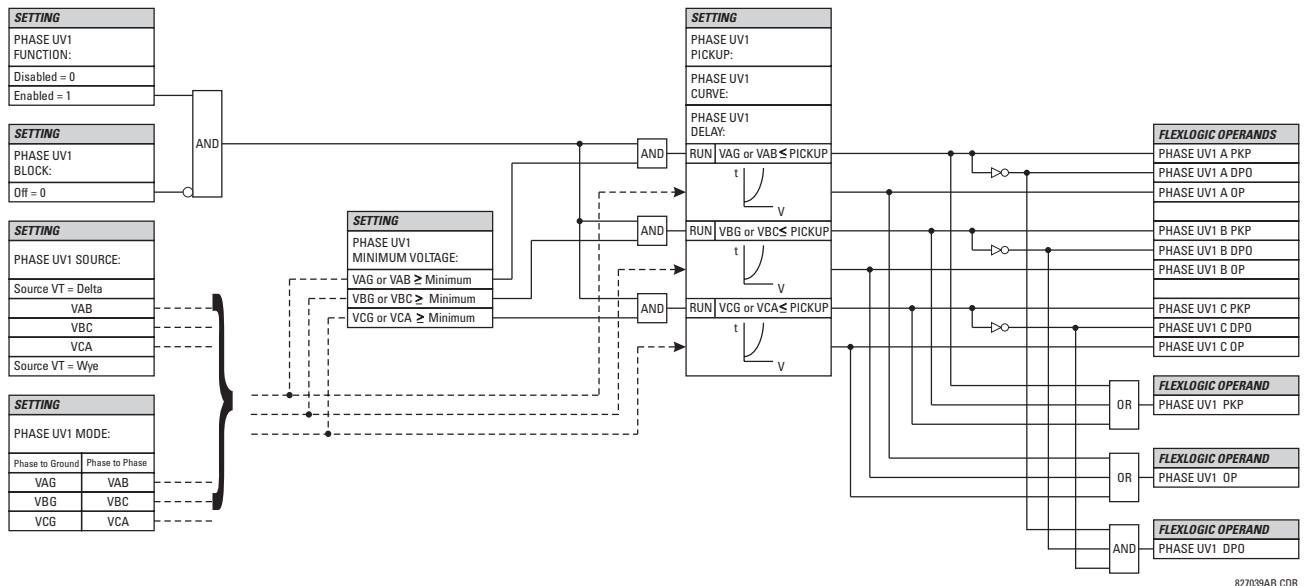

Figure 5-45: PHASE UNDERVOLTAGE1 SCHEME LOGIC

c) NEUTRAL OVERVOLTAGE (ANSI 59N)

PATH: SETTINGS ⇒ GROUPED ELEMENTS ⇒ SETTING GROUP 1(6) ⇒ VOLTAGE ELEMENTS ⇒ NEUTRAL OV1

■ NEUTRAL OV1	◀▶	NEUTRAL OV1 FUNCTION: Disabled	Range: Disabled, Enabled
MESSAGE	▲▼	NEUTRAL OV1 SIGNAL SOURCE: SRC 1	Range: SRC 1, SRC 2, SRC 3, SRC 4, SRC 5, SRC 6
MESSAGE	▲▼	NEUTRAL OV1 PICKUP: 0.300 pu	Range: 0.000 to 1.250 pu in steps of 0.001
MESSAGE	▲▼	NEUTRAL OV1 PICKUP: DELAY: 1.00 s	Range: 0.00 to 600.00 s in steps of 0.01
MESSAGE	▲▼	NEUTRAL OV1 RESET: DELAY: 1.00 s	Range: 0.00 to 600.00 s in steps of 0.01
MESSAGE	▲▼	NEUTRAL OV1 BLOCK: Off	Range: FlexLogic™ operand
MESSAGE	▲▼	NEUTRAL OV1 TARGET: Self-reset	Range: Self-reset, Latched, Disabled
MESSAGE	▲	NEUTRAL OV1 EVENTS: Disabled	Range: Disabled, Enabled

5

The Neutral Overvoltage element can be used to detect asymmetrical system voltage condition due to a ground fault or to the loss of one or two phases of the source. The element responds to the system neutral voltage (3V_0), calculated from the phase voltages. The nominal secondary voltage of the phase voltage channels entered under **SETTINGS** ⇒ **SYSTEM SETUP** ⇒ **AC INPUTS** ⇒ **VOLTAGE BANK** ⇒ **PHASE VT SECONDARY** is the p.u. base used when setting the pickup level.

VT errors and normal voltage unbalance must be considered when setting this element. This function requires the VTs to be Wye connected.

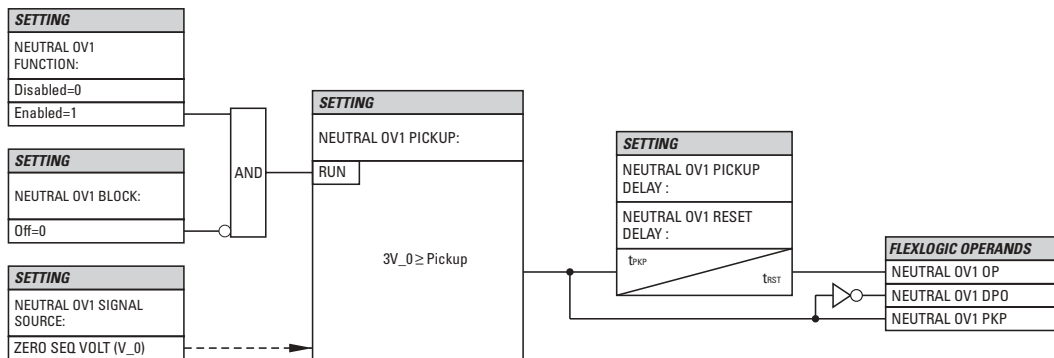

827848A1.CDR

Figure 5–46: NEUTRAL OVERVOLTAGE1 SCHEME LOGIC

d) AUXILIARY UNDERVOLTAGE (ANSI 27X)

PATH: SETTINGS ⇒ GROUPED ELEMENTS ⇒ SETTING GROUP 1(6) ⇒ VOLTAGE ELEMENTS ⇒ AUXILIARY UV1

<input checked="" type="checkbox"/> AUXILIARY UV1	◀▶	AUX UV1 FUNCTION: Disabled	Range: Disabled, Enabled
MESSAGE	▲▼	AUX UV1 SIGNAL SOURCE: SRC 1	Range: SRC 1, SRC 2, SRC 3, SRC 4, SRC 5, SRC 6
MESSAGE	▲▼	AUX UV1 PICKUP: 0.700 pu	Range: 0.000 to 3.000 pu in steps of 0.001
MESSAGE	▲▼	AUX UV1 CURVE: Definite Time	Range: Definite Time, Inverse Time
MESSAGE	▲▼	AUX UV1 DELAY: 1.00 s	Range: 0.00 to 600.00 s in steps of 0.01
MESSAGE	▲▼	AUX UV1 MINIMUM: VOLTAGE: 0.100 pu	Range: 0.000 to 3.000 pu in steps of 0.001
MESSAGE	▲▼	AUX UV1 BLOCK: Off	Range: FlexLogic™ operand
MESSAGE	▲▼	AUX UV1 TARGET: Self-reset	Range: Self-reset, Latched, Disabled
MESSAGE	▲	AUX UV1 EVENTS: Disabled	Range: Disabled, Enabled

This element is intended for monitoring undervoltage conditions of the auxiliary voltage. The **AUX UV1 PICKUP** selects the voltage level at which the time undervoltage element starts timing. The nominal secondary voltage of the auxiliary voltage channel entered under **SETTINGS ⇒ SYSTEM SETUP ⇒ AC INPUTS ⇒ VOLTAGE BANK X5 ⇒ AUXILIARY VT X5 SECONDARY** is the p.u. base used when setting the pickup level.

The **AUX UV1 DELAY** setting selects the minimum operating time of the auxiliary undervoltage element. Both **AUX UV1 PICKUP** and **AUX UV1 DELAY** settings establish the operating curve of the undervoltage element. The auxiliary undervoltage element can be programmed to use either Definite Time Delay or Inverse Time Delay characteristics. The operating characteristics and equations for both Definite and Inverse Time Delay are as for the Phase Undervoltage element.

The element resets instantaneously. The minimum voltage setting selects the operating voltage below which the element is blocked.

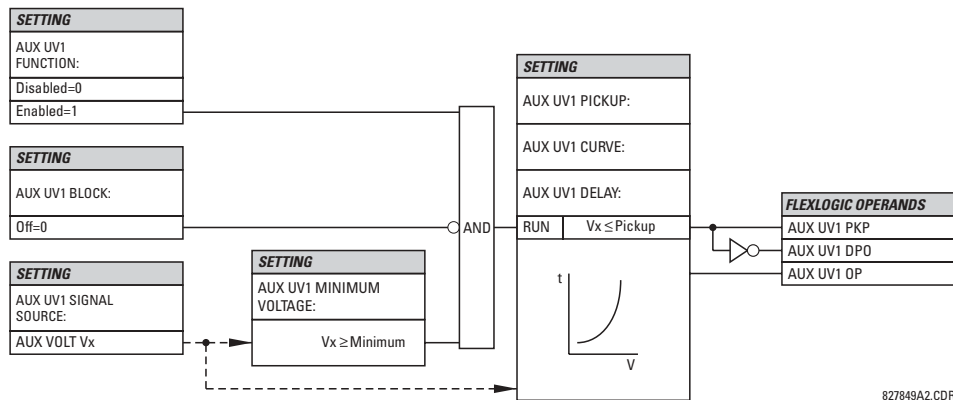

Figure 5-47: AUXILIARY UNDERVOLTAGE SCHEME LOGIC

e) AUXILIARY OVERVOLTAGE (ANSI 59X)

PATH: SETTINGS ⇒ GROUPED ELEMENTS ⇒ SETTING GROUP 1(6) ⇒ VOLTAGE ELEMENTS ⇒ AUXILIARY OV1

AUXILIARY OV1		AUX OV1	Range: Disabled, Enabled
		FUNCTION: Disabled	
MESSAGE		AUX OV1 SIGNAL	Range: SRC 1, SRC 2, SRC 3, SRC 4, SRC 5, SRC 6
		SOURCE: SRC 1	
MESSAGE		AUX OV1 PICKUP:	Range: 0.000 to 3.000 pu in steps of 0.001
		0.300 pu	
MESSAGE		AUX OV1 PICKUP	Range: 0.00 to 600.00 s in steps of 0.01
		DELAY: 1.00 s	
MESSAGE		AUX OV1 RESET	Range: 0.00 to 600.00 s in steps of 0.01
		DELAY: 1.00 s	
MESSAGE		AUX OV1 BLOCK:	Range: FlexLogic™ operand
		Off	
MESSAGE		AUX OV1 TARGET:	Range: Self-reset, Latched, Disabled
		Self-reset	
MESSAGE		AUX OV1 EVENTS:	Range: Disabled, Enabled
		Disabled	

5

This element is intended for monitoring overvoltage conditions of the auxiliary voltage. The nominal secondary voltage of the auxiliary voltage channel entered under **SYSTEM SETUP ⇒ AC INPUTS** ⇒ **VOLTAGE BANK X5** ⇒ **AUXILIARY VT X5 SECONDARY** is the p.u. base used when setting the pickup level.

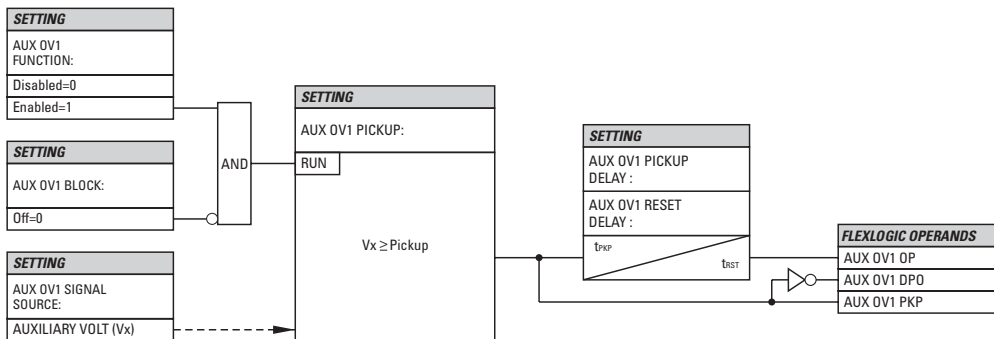

827836A2.CDR

Figure 5-48: AUXILIARY OVERVOLTAGE SCHEME LOGIC

5.6.1 OVERVIEW

Control elements are generally used for control rather than protection. See the *Introduction to Elements* section at the beginning of this chapter for further information.

5.6.2 SETTING GROUPS

PATH: SETTINGS ⇄ CONTROL ELEMENTS ⇄ SETTINGS GROUPS

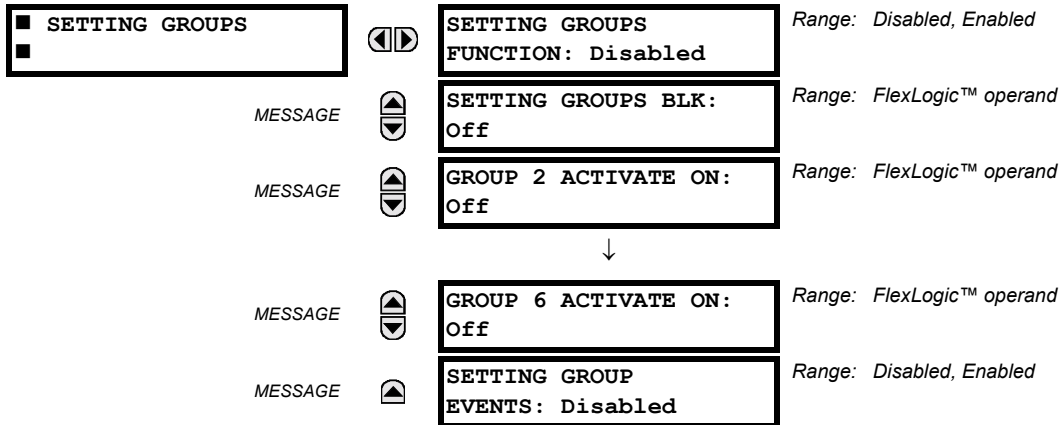

The Setting Groups menu controls the activation/deactivation of up to six possible groups of settings in the **GROUPED ELEMENTS** settings menu. The faceplate ‘Settings In Use’ LEDs indicate which active group (with a non-flashing energized LED) is in service.

The **SETTING GROUPS BLK** setting prevents the active setting group from changing when the FlexLogic™ parameter is set to “On”. This can be useful in applications where it is undesirable to change the settings under certain conditions, such as the breaker being open.

Each **GROUP n ACTIVATE ON** setting selects a FlexLogic™ operand which, when set, will make the particular setting group active for use by any grouped element. A priority scheme ensures that only one group is active at a given time – the highest-numbered group which is activated by its **GROUP n ACTIVATE ON** parameter takes priority over the lower-numbered groups. There is no “activate on” setting for Group 1 (the default active group), because Group 1 automatically becomes active if no other group is active.

The relay can be set up via a FlexLogic™ equation to receive requests to activate or de-activate a particular non-default settings group. The following FlexLogic™ equation (see the figure below) illustrates requests via remote communications (e.g. VIRTUAL INPUT 1) or from a local contact input (e.g. H7a) to initiate the use of a particular settings group, and requests from several overcurrent pickup measuring elements to inhibit the use of the particular settings group. The assigned VIRTUAL OUTPUT 1 operand is used to control the “On” state of a particular settings group.

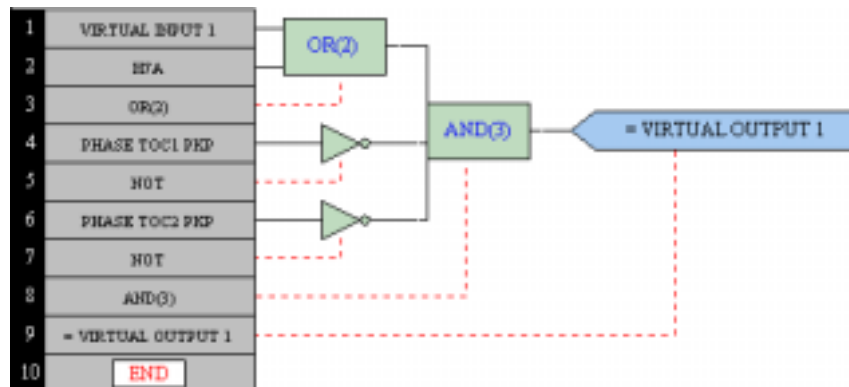

Figure 5–49: EXAMPLE FLEXLOGIC™ CONTROL OF A SETTINGS GROUP

5.6.3 SELECTOR SWITCH

PATH: SETTINGS ⇨ CONTROL ELEMENTS ⇨ SELECTOR SWITCH ⇨ SELECTOR SWITCH 1(2)

■ SELECTOR SWITCH 1	◀▶	SELECTOR 1 FUNCTION: Disabled	Range: Disabled, Enabled
MESSAGE	▲▼	SELECTOR 1 FULL RANGE: 7	Range: 1 to 7 in steps of 1
MESSAGE	▲▼	SELECTOR 1 TIME-OUT: 5.0 s	Range: 3.0 to 60.0 s in steps of 0.1
MESSAGE	▲▼	SELECTOR 1 STEP-UP: Off	Range: FlexLogic™ operand
MESSAGE	▲▼	SELECTOR 1 STEP-UP MODE: Time-out	Range: Time-out, Acknowledge
MESSAGE	▲▼	SELECTOR 1 ACK: Off	Range: FlexLogic™ operand
MESSAGE	▲▼	SELECTOR 1 3BIT A0: Off	Range: FlexLogic™ operand
MESSAGE	▲▼	SELECTOR 1 3BIT A1: Off	Range: FlexLogic™ operand
MESSAGE	▲▼	SELECTOR 1 3BIT A2: Off	Range: FlexLogic™ operand
MESSAGE	▲▼	SELECTOR 1 3BIT MODE: Time-out	Range: Time-out, Acknowledge
MESSAGE	▲▼	SELECTOR 1 3BIT ACK: Off	Range: FlexLogic™ operand
MESSAGE	▲▼	SELECTOR 1 POWER-UP MODE: Restore	Range: Restore, Synchronize, Sync/Restore
MESSAGE	▲▼	SELECTOR 1 TARGETS: Self-reset	Range: Self-reset, Latched, Disabled
MESSAGE	▲	SELECTOR 1 EVENTS: Disabled	Range: Disabled, Enabled

The Selector Switch element is intended to replace a mechanical selector switch. Typical applications include setting group control or control of multiple logic sub-circuits in user-programmable logic.

The element provides for two control inputs. The step-up control allows stepping through selector position one step at a time with each pulse of the control input, such as a user-programmable pushbutton. The 3-bit control input allows setting the selector to the position defined by a 3-bit word.

The element allows pre-selecting a new position without applying it. The pre-selected position gets applied either after time-out or upon acknowledgement via separate inputs (user setting). The selector position is stored in non-volatile memory. Upon power-up, either the previous position is restored or the relay synchronizes to the current 3-bit word (user setting). Basic alarm functionality alerts the user under abnormal conditions; e.g. the 3-bit control input being out of range.

- **SELECTOR 1 FULL RANGE:** This setting defines the upper position of the selector. When stepping up through available positions of the selector, the upper position wraps up to the lower position (Position 1). When using a direct 3-bit control word for programming the selector to a desired position, the change would take place only if the control word is within the range of 1 to the **SELECTOR FULL RANGE**. If the control word is outside the range, an alarm is established by setting the **SELECTOR ALARM** FlexLogic™ operand for 3 seconds.
- **SELECTOR 1 TIME-OUT:** This setting defines the time-out period for the selector. This value is used by the relay in the following two ways. When the **SELECTOR STEP-UP MODE** is "Time-out", the setting specifies the required period of

inactivity of the control input after which the pre-selected position is automatically applied. When the **SELECTOR STEP-UP MODE** is “Acknowledge”, the setting specifies the period of time for the acknowledging input to appear. The timer is re-started by any activity of the control input. The acknowledging input must come before the **SELECTOR 1 TIME-OUT** timer expires; otherwise, the change will not take place and an alarm will be set.

- **SELECTOR 1 STEP-UP:** This setting specifies a control input for the selector switch. The switch is shifted to a new position at each rising edge of this signal. The position changes incrementally, wrapping up from the last (**SELECTOR 1 FULL RANGE**) to the first (Position 1). Consecutive pulses of this control operand must not occur faster than every 50 ms. After each rising edge of the assigned operand, the time-out timer is restarted and the **SELECTOR SWITCH 1: POS Z CHNG INITIATED** target message is displayed, where **Z** the pre-selected position. The message is displayed for the time specified by the **FLASH MESSAGE TIME** setting. The pre-selected position is applied after the selector times out (“Time-out” mode), or when the acknowledging signal appears before the element times out (“Acknowledge” mode). When the new position is applied, the relay displays the **SELECTOR SWITCH 1: POSITION Z IN USE** message. Typically, a user-programmable pushbutton is configured as the stepping up control input.
- **SELECTOR 1 STEP-UP MODE:** This setting defines the selector mode of operation. When set to “Time-out”, the selector will change its position after a pre-defined period of inactivity at the control input. The change is automatic and does not require any explicit confirmation of the intent to change the selector’s position. When set to “Acknowledge”, the selector will change its position only after the intent is confirmed through a separate acknowledging signal. If the acknowledging signal does not appear within a pre-defined period of time, the selector does not accept the change and an alarm is established by setting the **SELECTOR STP ALARM** output FlexLogic™ operand for 3 seconds.
- **SELECTOR 1 ACK:** This setting specifies an acknowledging input for the stepping up control input. The pre-selected position is applied on the rising edge of the assigned operand. This setting is active only under “Acknowledge” mode of operation. The acknowledging signal must appear within the time defined by the **SELECTOR 1 TIME-OUT** setting after the last activity of the control input. A user-programmable pushbutton is typically configured as the acknowledging input.
- **SELECTOR 1 3BIT A0, A1, and A2:** These settings specify a 3-bit control input of the selector. The 3-bit control word pre-selects the position using the following encoding convention:

A2	A1	A0	POSITION
0	0	0	rest
0	0	1	1
0	1	0	2
0	1	1	3
1	0	0	4
1	0	1	5
1	1	0	6
1	1	1	7

The “rest” position (0, 0, 0) does not generate an action and is intended for situations when the device generating the 3-bit control word is having a problem. When **SELECTOR 1 3BIT MODE** is “Time-out”, the pre-selected position is applied in **SELECTOR 1 TIME-OUT** seconds after the last activity of the 3-bit input. When **SELECTOR 1 3BIT MODE** is “Acknowledge”, the pre-selected position is applied on the rising edge of the **SELECTOR 1 3BIT ACK** acknowledging input.

The stepping up control input (**SELECTOR 1 STEP-UP**) and the 3-bit control inputs (**SELECTOR 1 3BIT A0** through **A2**) lock-out mutually: once the stepping up sequence is initiated, the 3-bit control input is inactive; once the 3-bit control sequence is initiated, the stepping up input is inactive.

- **SELECTOR 1 3BIT MODE:** This setting defines the selector mode of operation. When set to “Time-out”, the selector changes its position after a pre-defined period of inactivity at the control input. The change is automatic and does not require explicit confirmation to change the selector position. When set to “Acknowledge”, the selector changes its position only after confirmation via a separate acknowledging signal. If the acknowledging signal does not appear within a pre-defined period of time, the selector rejects the change and an alarm established by invoking the **SELECTOR BIT ALARM** FlexLogic™ operand for 3 seconds.
- **SELECTOR 1 3BIT ACK:** This setting specifies an acknowledging input for the 3-bit control input. The pre-selected position is applied on the rising edge of the assigned FlexLogic™ operand. This setting is active only under the “Acknowledge” mode of operation. The acknowledging signal must appear within the time defined by the **SELECTOR TIME-OUT** setting after the last activity of the 3-bit control inputs. Note that the stepping up control input and 3-bit control input have independent acknowledging signals (**SELECTOR 1 ACK** and **SELECTOR 1 3BIT ACK**, accordingly).

- SELECTOR 1 POWER-UP MODE:** This setting specifies behavior of the element on power up of the relay. When set to “Restore”, the last selector position, stored in non-volatile memory, is restored after powering up the relay. When set to “Synchronize”, the selector sets to the current 3-bit control input after powering up the relay. This operation does not wait for time-out or the acknowledging input. When powering up, the rest position (0, 0, 0) and the out-of-range 3-bit control words are also ignored, the output is set to Position 0 (no output operand selected), and an alarm is established (SELECTOR 1 PWR ALARM). If the position restored from memory is out-of-range, Position 0 (no output operand selected) is applied and an alarm is set (SELECTOR 1 PWR ALARM).
- SELECTOR 1 EVENTS:** If enabled, the following events are logged:

EVENT NAME	DESCRIPTION
SELECTOR 1 POS Z	Selector 1 changed its position to Z.
SELECTOR 1 STP ALARM	The selector position pre-selected via the stepping up control input has not been confirmed before the time out.
SELECTOR 1 BIT ALARM	The selector position pre-selected via the 3-bit control input has not been confirmed before the time out.

The following figures illustrate the operation of the Selector Switch. In these diagrams, “T” represents a time-out setting.

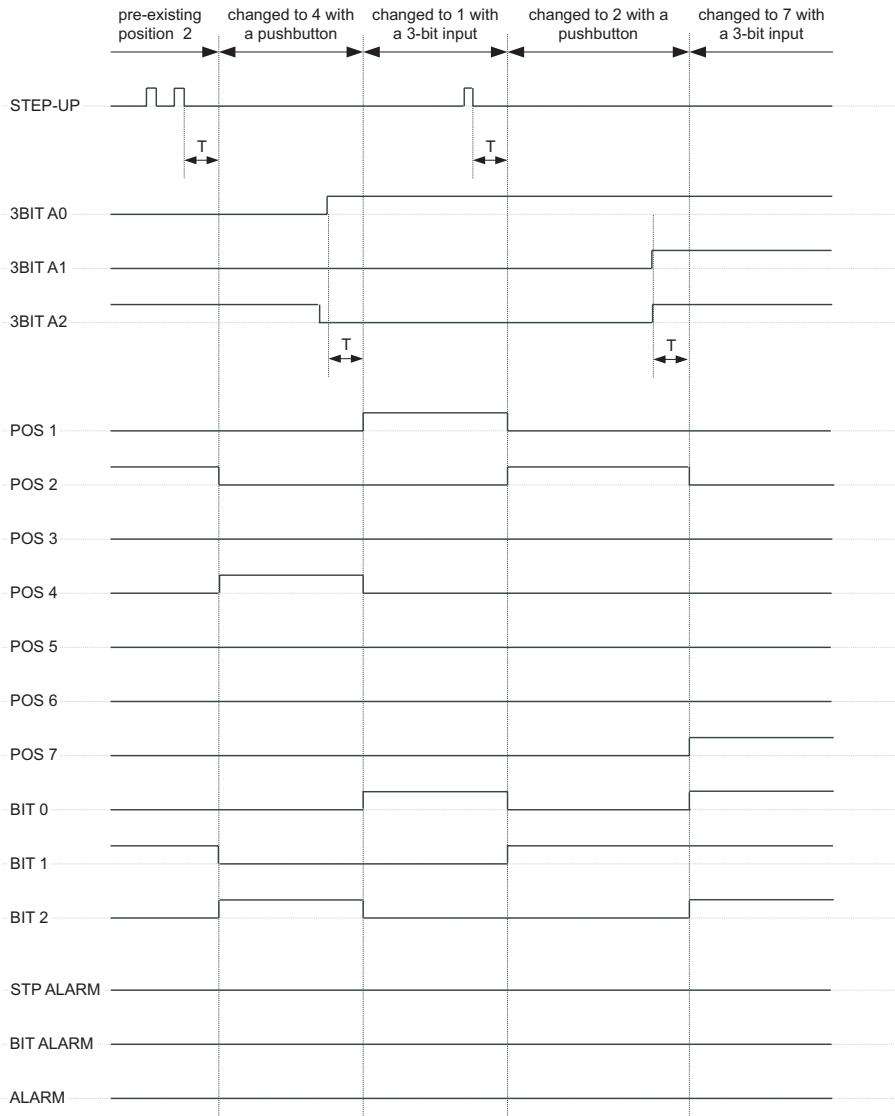
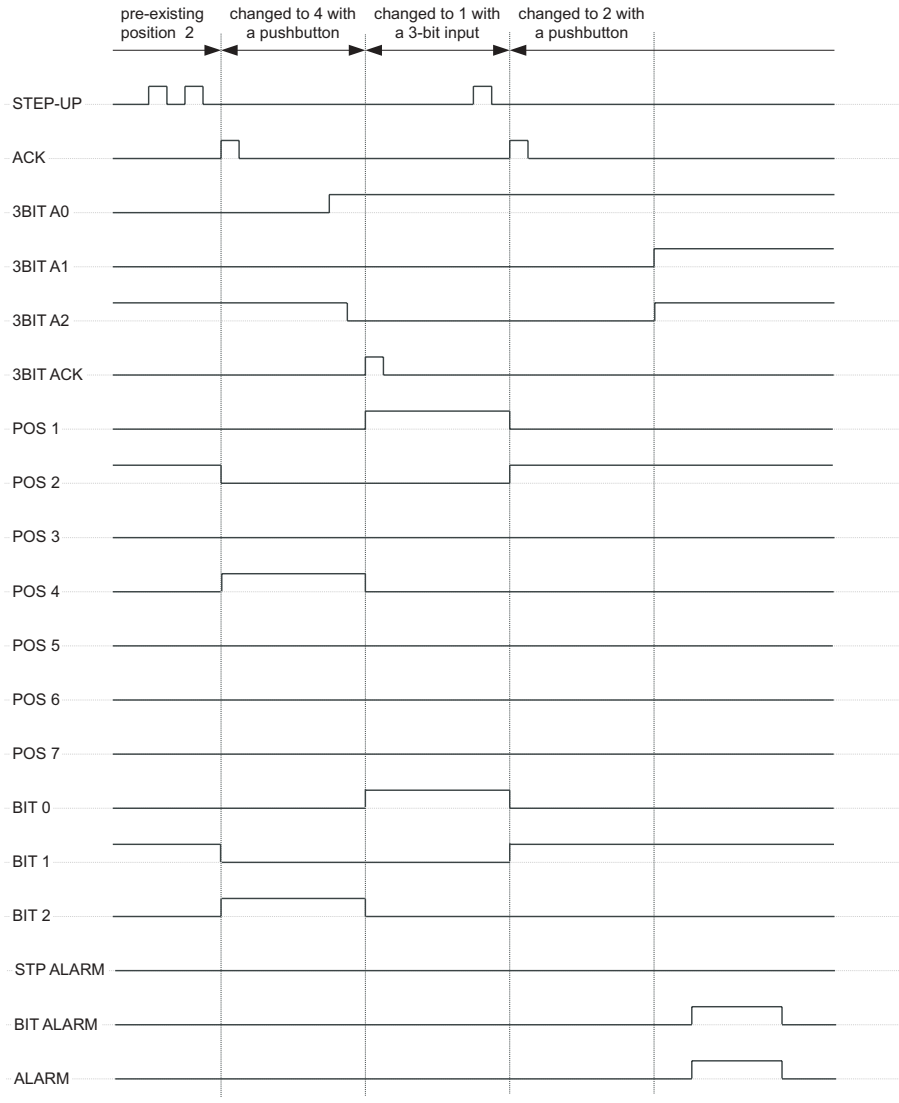

Figure 5–50: TIME-OUT MODE

842737A1.CDR



842736A1.CDR

Figure 5–51: ACKNOWLEDGE MODE

APPLICATION EXAMPLE

Consider an application where the selector switch is used to control Setting Groups 1 through 4 in the relay. The setting groups are to be controlled from both User-Programmable Pushbutton 1 and from an external device via Contact Inputs 1 through 3. The active setting group shall be available as an encoded 3-bit word to the external device and SCADA via output contacts 1 through 3. The pre-selected setting group shall be applied automatically after 5 seconds of inactivity of the control inputs. When the relay powers up, it should synchronize the setting group to the 3-bit control input.

Make the following changes to Setting Group Control in the **SETTINGS** ⇨ **CONTROL ELEMENTS** ⇨ **SETTING GROUPS** menu:

- SETTING GROUPS FUNCTION: "Enabled"
- SETTING GROUPS BLK: "Off"
- GROUP 2 ACTIVATE ON: "SELECTOR 1 POS 2"
- GROUP 3 ACTIVATE ON: "SELECTOR 1 POS 3"
- GROUP 4 ACTIVATE ON: "SELECTOR 1 POS 4"
- GROUP 5 ACTIVATE ON: "Off"
- GROUP 6 ACTIVATE ON: "Off"

Make the following changes to Selector Switch element in the **SETTINGS** ⇨ **CONTROL ELEMENTS** ⇨ **SELECTOR SWITCH** ⇨ **SELECTOR SWITCH 1** menu to assign control to User Programmable Pushbutton 1 and Contact Inputs 1 through 3:

- SELECTOR 1 FUNCTION: "Enabled"
- SELECTOR 1 FULL-RANGE: "4"
- SELECTOR 1 STEP-UP MODE: "Time-out"
- SELECTOR 1 TIME-OUT: "5.0 s"
- SELECTOR 1 STEP-UP: "PUSHBUTTON 1 ON"
- SELECTOR 1 ACK: "Off"
- SELECTOR 1 3BIT A0: "CONT IP 1 ON"
- SELECTOR 1 3BIT A1: "CONT IP 2 ON"
- SELECTOR 1 3BIT A2: "CONT IP 3 ON"
- SELECTOR 1 3BIT MODE: "Time-out"
- SELECTOR 1 3BIT ACK: "Off"
- SELECTOR 1 POWER-UP MODE: "Synchronize"

Now, assign the contact output operation (assume the H6E module) to the Selector Switch element by making the following changes in the **SETTINGS** ⇨ **INPUTS/OUTPUTS** ⇨ **CONTACT OUTPUTS** menu:

- OUTPUT H1 OPERATE: "SELECTOR 1 BIT 0"
- OUTPUT H2 OPERATE: "SELECTOR 1 BIT 1"
- OUTPUT H3 OPERATE: "SELECTOR 1 BIT 2"

Finally, assign configure User-Programmable Pushbutton 1 by making the following changes in the **SETTINGS** ⇨ **PRODUCT SETUP** ⇨ **USER-PROGRAMMABLE PUSHBUTTONS** ⇨ **USER PUSHBUTTON 1** menu:

- PUSHBUTTON 1 FUNCTION: "Self-reset"
- PUSHBUTTON 1 DROP-OUT TIME: "0.10 s"

The logic for the selector switch is shown below:

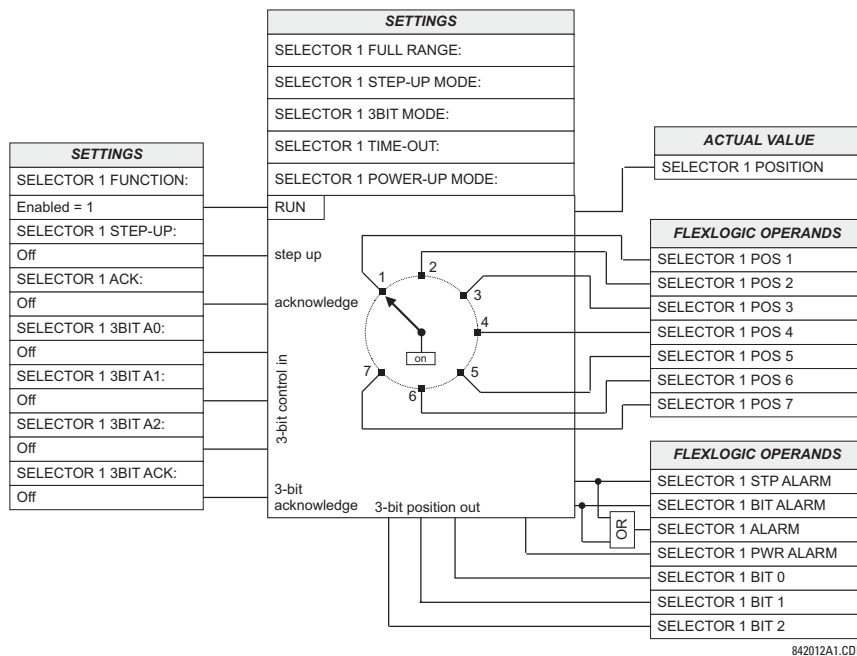

Figure 5-52: SELECTOR SWITCH LOGIC

5.6.4 UNDERFREQUENCY

PATH: SETTINGS ⇄ CONTROL ELEMENTS ⇄ UNDERFREQUENCY ⇄ UNDERFREQUENCY 1(6)

■ UNDERFREQUENCY 1	◀▶	UND FREQ 1 FUNCTION: Disabled	Range: Disabled, Enabled
MESSAGE	▲▼	UND FREQ 1 BLOCK: Off	Range: FlexLogic™ operand
MESSAGE	▲▼	UND FREQ 1 SOURCE: SRC 1	Range: SRC 1, SRC 2, SRC 3, SRC 4, SRC 5, SRC 6
MESSAGE	▲▼	UND FREQ 1 MIN VOLT/AMP: 0.10 pu	Range: 0.10 to 1.25 pu in steps of 0.01
MESSAGE	▲▼	UND FREQ 1 PICKUP: 59.50 Hz	Range: 20.00 to 65.00 Hz in steps of 0.01
MESSAGE	▲▼	UND FREQ 1 PICKUP DELAY: 2.000 s	Range: 0.000 to 65.535 s in steps of 0.001
MESSAGE	▲▼	UND FREQ 1 RESET DELAY : 2.000 s	Range: 0.000 to 65.535 s in steps of 0.001
MESSAGE	▲▼	UND FREQ 1 TARGET: Self-reset	Range: Self-reset, Latched, Disabled
MESSAGE	▲	UND FREQ 1 EVENTS: Disabled	Range: Disabled, Enabled

There are six identical underfrequency elements, numbered from 1 through 6 inclusive.

The steady-state frequency of a power system is a certain indicator of the existing balance between the generated power and the load. Whenever this balance is disrupted through the loss of an important generating unit or the isolation of part of the system from the rest of the system, the effect will be a reduction in frequency. If the control systems of the system generators do not respond fast enough, the system may collapse. A reliable method to quickly restore the balance between load and generation is to automatically disconnect selected loads, based on the actual system frequency. This technique, called "load-shedding", maintains system integrity and minimize widespread outages. After the frequency returns to normal, the load may be automatically or manually restored.

The **UND FREQ 1 SOURCE** setting is used to select the source for the signal to be measured. The element first checks for a live phase voltage available from the selected Source. If voltage is not available, the element attempts to use a phase current. If neither voltage nor current is available, the element will not operate, as it will not measure a parameter above the minimum voltage/current setting.

The **UND FREQ 1 MIN VOLT/AMP** setting selects the minimum per unit voltage or current level required to allow the underfrequency element to operate. This threshold is used to prevent an incorrect operation because there is no signal to measure.

This **UND FREQ 1 PICKUP** setting is used to select the level at which the underfrequency element is to pickup. For example, if the system frequency is 60 Hz and the load shedding is required at 59.5 Hz, the setting will be 59.50 Hz.

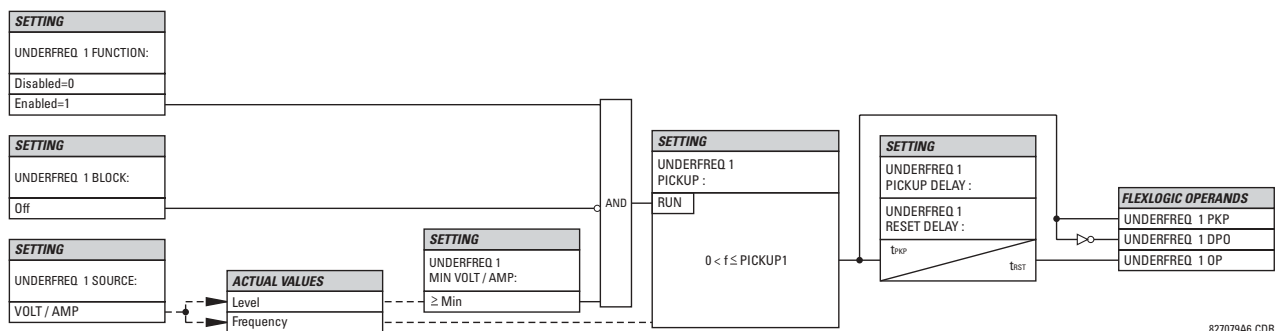







Figure 5-53: UNDERFREQUENCY SCHEME LOGIC

5.6.5 AUTORECLOSE

PATH: SETTINGS ⇨ CONTROL ELEMENTS ⇨ AUTORECLOSE ⇨ AUTORECLOSE 1(6)

<div style="border: 1px solid black; padding: 2px;"> ■ AUTORECLOSE 1 </div>			AR1 FUNCTION: Disabled	Range: Disabled, Enabled
MESSAGE		AR1 INITIATE: Off	Range: FlexLogic™ operand	
MESSAGE		AR1 BLOCK: Off	Range: FlexLogic™ operand	
MESSAGE		AR1 MAX NUMBER OF SHOTS: 1	Range: 1, 2, 3, 4	
MESSAGE		AR1 REDUCE MAX TO 1: Off	Range: FlexLogic™ operand	
MESSAGE		AR1 REDUCE MAX TO 2: Off	Range: FlexLogic™ operand	
MESSAGE		AR1 REDUCE MAX TO 3: Off	Range: FlexLogic™ operand	
MESSAGE		AR1 MANUAL CLOSE: Off	Range: FlexLogic™ operand	
MESSAGE		AR1 MNL RST FRM LO: Off	Range: FlexLogic™ operand	
MESSAGE		AR1 RESET LOCKOUT IF BREAKER CLOSED: Off	Range: Off, On	
MESSAGE		AR1 RESET LOCKOUT ON MANUAL CLOSE: Off	Range: Off, On	
MESSAGE		AR1 BKR CLOSED: Off	Range: FlexLogic™ operand	
MESSAGE		AR1 BKR OPEN: Off	Range: FlexLogic™ operand	
MESSAGE		AR1 BLK TIME UPON MNL CLS: 10.000 s	Range: 0.00 to 655.35 s in steps of 0.01	
MESSAGE		AR1 DEAD TIME 1: 1.000 s	Range: 0.00 to 655.35 s in steps of 0.01	
MESSAGE		AR1 DEAD TIME 2: 2.000 s	Range: 0.00 to 655.35 s in steps of 0.01	
MESSAGE		AR1 DEAD TIME 3: 3.000 s	Range: 0.00 to 655.35 s in steps of 0.01	
MESSAGE		AR1 DEAD TIME 4: 4.000 s	Range: 0.00 to 655.35 s in steps of 0.01	
MESSAGE		AR1 ADD DELAY 1: Off	Range: FlexLogic™ operand	
MESSAGE		AR1 DELAY 1: 0.000 s	Range: 0.00 to 655.35 s in steps of 0.01	
MESSAGE		AR1 ADD DELAY 2: Off	Range: FlexLogic™ operand	

MESSAGE		AR1 DELAY 2 : 0.000 s	Range: 0.00 to 655.35 s in steps of 0.01
MESSAGE		AR1 RESET LOCKOUT DELAY: 60.000	Range: 0.00 to 655.35 s in steps of 0.01
MESSAGE		AR1 RESET TIME : 60.000 s	Range: 0.00 to 655.35 s in steps of 0.01
MESSAGE		AR1 INCOMPLETE SEQ TIME: 5.000 s	Range: 0.00 to 655.35 s in steps of 0.01
MESSAGE		AR1 EVENTS: Disabled	Range: Disabled, Enabled

The maximum number of autoreclosure elements available is equal to the number of installed CT banks.

The autoreclosure feature is intended for use with transmission and distribution lines, in three-pole tripping schemes for single breaker applications. Up to four selectable reclosures ‘shots’ are possible prior to locking out. Each shot has an independently settable dead time. The protection settings can be changed between shots if so desired, using FlexLogic™. Logic inputs are available for disabling or blocking the scheme.

Faceplate panel LEDs indicate the state of the autoreclose scheme as follows:

- Reclose Enabled: The scheme is enabled and may reclose if initiated.
- Reclose Disabled: The scheme is disabled.
- Reclose In Progress: An autoreclosure has been initiated but the breaker has not yet been signaled to close.
- Reclose Locked Out: The scheme has generated the maximum number of breaker closures allowed and, as the fault persists, will not close the breaker again; known as ‘Lockout’. The scheme may also be sent in ‘Lockout’ when the incomplete sequence timer times out or when a block signal occurs while in ‘reclose in progress’. The scheme must be reset from Lockout in order to perform reclose for further faults.

The reclosure scheme is considered *enabled* when all of the following conditions are true:

- The **AR1(6) FUNCTION** is set to “Enabled”.
- The scheme is not in the ‘Lockout’ state.
- The ‘Block’ input is not asserted.
- The **AR1(6) BLK TIME UPON MNL CLS** timer is not active.

The autoreclose scheme is initiated by a trip signal from any selected protection feature operand. The scheme is initiated provided the circuit breaker is in the closed state before protection operation.

The reclose-in-progress (RIP) is set when a reclosing cycle begins following a reclose initiate signal. Once the cycle is successfully initiated, the RIP signal will seal-in and the scheme will continue through its sequence until one of the following conditions is satisfied:

- The close signal is issued when the dead timer times out, or
- The scheme goes to lockout.

While RIP is active, the scheme checks that the breaker is open and the shot number is below the limit, and then begins measuring the dead time.

Each of the four possible shots has an independently settable dead time. Two additional timers can be used to increase the initial set dead times 1 to 4 by a delay equal to **AR1(6) DELAY 1** or **AR1(6) DELAY 2** or the sum of these two delays depending on the selected settings. This offers enhanced setting flexibility using FlexLogic™ operands to turn the two additional timers “on” and “off”. These operands may possibly include AR1 SHOT CNT =n, SETTING GROUP ACT 1, etc. The autoreclose provides up to maximum 4 selectable shots. Maximum number of shots can be dynamically modified through the settings **AR1(6) REDUCE MAX TO 1 (2, 3)**, using the appropriate FlexLogic™ operand.

Scheme lockout blocks all phases of the reclosing cycle, preventing automatic reclosure, if any of the following occurs:

- The maximum shot number was reached.
- A ‘Block’ input is in effect (for instance; Breaker Failure, bus differential protection operated, etc.).

- The 'Incomplete Sequence' timer times out.

The recloser will be latched in the Lockout state until a 'Reset from lockout' signal is asserted, either from a manual close of the breaker or from a manual reset command (local or remote). The reset from lockout can be accomplished by operator command, by manually closing the breaker, or whenever the breaker has been closed and stays closed for a preset time.

After the dead time elapses, the scheme issues the close signal. The close signal is latched until the breaker closes or the scheme goes to Lockout.

A reset timer output resets the recloser following a successful reclosure sequence. The reset time is based on the breaker 'reclaim time' which is the minimum time required between successive reclose sequences.

SETTINGS:

- **AR1(6) INITIATE:** Selects the FlexLogic™ operand that initiates the scheme, typically the trip signal from protection.
- **AR1(6) BLOCK:** Selects the FlexLogic™ operand that blocks the autoreclosure initiate (it could be from the breaker failure, bus differential protection, etc.).
- **AR1(6) MAX NUMBER OF SHOTS:** Specifies the number of reclosures that can be attempted before reclosure goes to "Lockout" because the fault is permanent.
- **AR1(6) REDUCE MAX TO 1(3):** Selects the FlexLogic™ operand that changes the maximum number of shots from the initial setting to 1, 2, or 3, respectively.
- **AR1(6) MANUAL CLOSE:** Selects the logic input set when the breaker is manually closed.
- **AR1(6) MNL RST FRM LO:** Selects the FlexLogic™ operand that resets the autoreclosure from Lockout condition. Typically this is a manual reset from lockout, local or remote.
- **AR1(6) RESET LOCKOUT IF BREAKER CLOSED:** This setting allows the autoreclosure scheme to reset from Lockout if the breaker has been manually closed and stays closed for a preset time. In order for this setting to be effective, the next setting (**AR1(6) RESET LOCKOUT ON MANUAL CLOSE**) should be disabled.
- **AR1(6) RESET LOCKOUT ON MANUAL CLOSE:** This setting allows the autoreclosure scheme to reset from Lockout when the breaker is manually closed regardless if the breaker remains closed or not. This setting overrides the previous setting (**AR1 RESET LOCKOUT IF BREAKER CLOSED**).
- **AR1(6) BLK TIME UPON MNL CLS:** The autoreclosure scheme can be disabled for a programmable time delay after the associated circuit breaker is manually closed. This prevents reclosing onto a fault after a manual close. This delay must be longer than the slowest expected trip from any protection not blocked after manual closing. If no overcurrent trips occur after a manual close and this time expires, the autoreclosure scheme is enabled.
- **AR1(6) DEAD TIME 1 to AR1(6) DEAD TIME 4:** These are the intentional delays before first, second, third, and fourth breaker automatic reclosures (1st, 2nd, and 3rd shots), respectively, and should be set longer than the estimated deionizing time following a three pole trip.
- **AR1(6) ADD DELAY 1:** This setting selects the FlexLogic™ operand that introduces an additional delay (Delay 1) to the initial set Dead Time (1 to 4). When this setting is "Off", Delay 1 is by-passed.
- **AR1(6) DELAY 1:** This setting establishes the extent of the additional dead time Delay 1.
- **AR1(6) ADD DELAY 2:** This setting selects the FlexLogic™ operand that introduces an additional delay (Delay 2) to the initial set Dead Time (1 to 4). When this setting is "Off", Delay 2 is by-passed.
- **AR1(6) DELAY 2:** This setting establishes the extent of the additional dead time Delay 2.
- **AR1(6) RESET LOCKOUT DELAY:** This setting establishes how long the breaker should stay closed after a manual close command, in order for the autorecloser to reset from Lockout.
- **AR1(6) RESET TIME:** A reset timer output resets the recloser following a successful reclosure sequence. The setting is based on the breaker 'reclaim time' which is the minimum time required between successive reclose sequences.
- **AR1(6) INCOMPLETE SEQ TIME:** This timer defines the maximum time interval allowed for a single reclose shot. It is started whenever a reclosure is initiated and is active when the scheme is in the 'reclose-in-progress' state. If all conditions allowing a breaker closure are not satisfied when this time expires, the scheme goes to "Lockout".



This timer must be set to a delay less than the reset timer.

NOTE

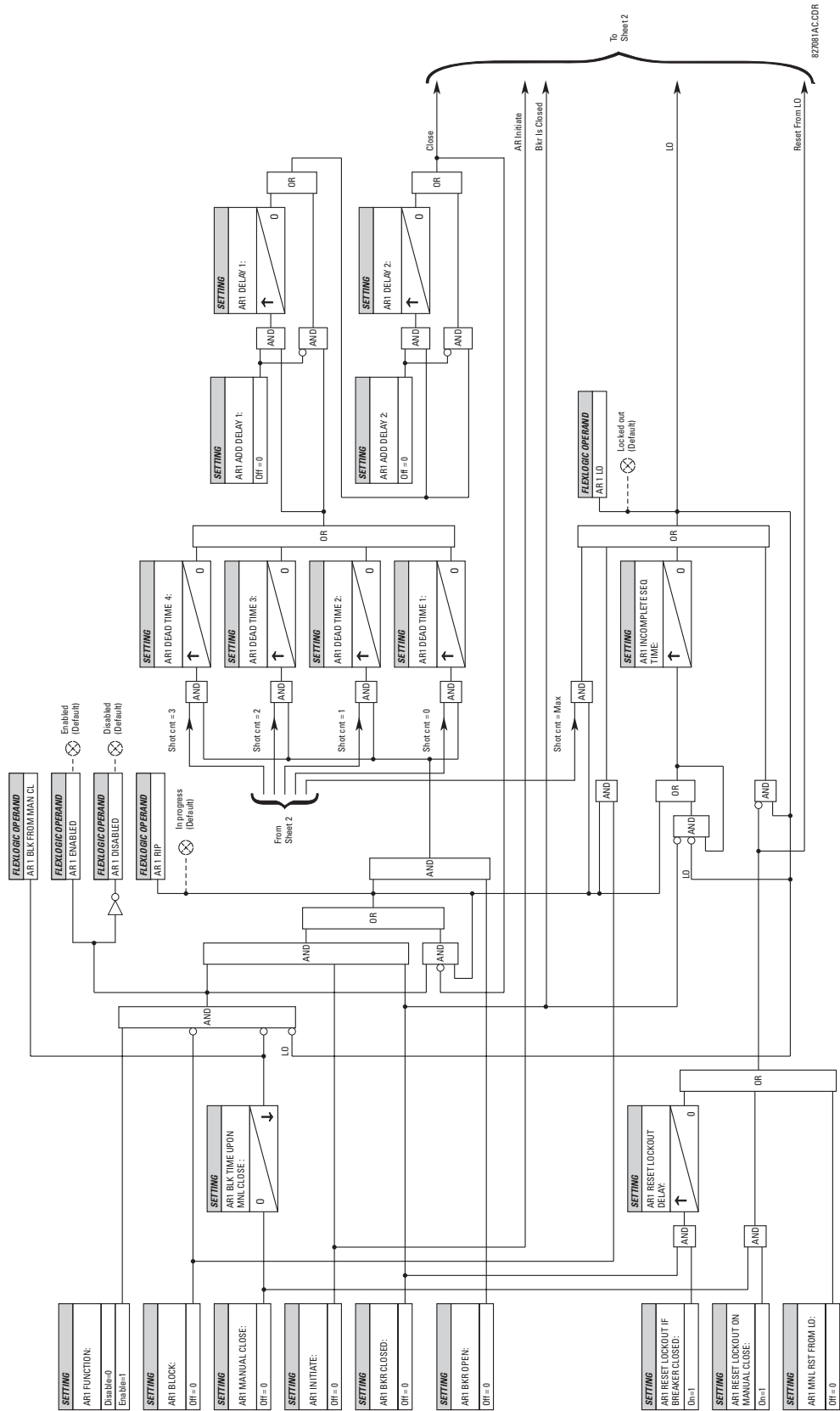
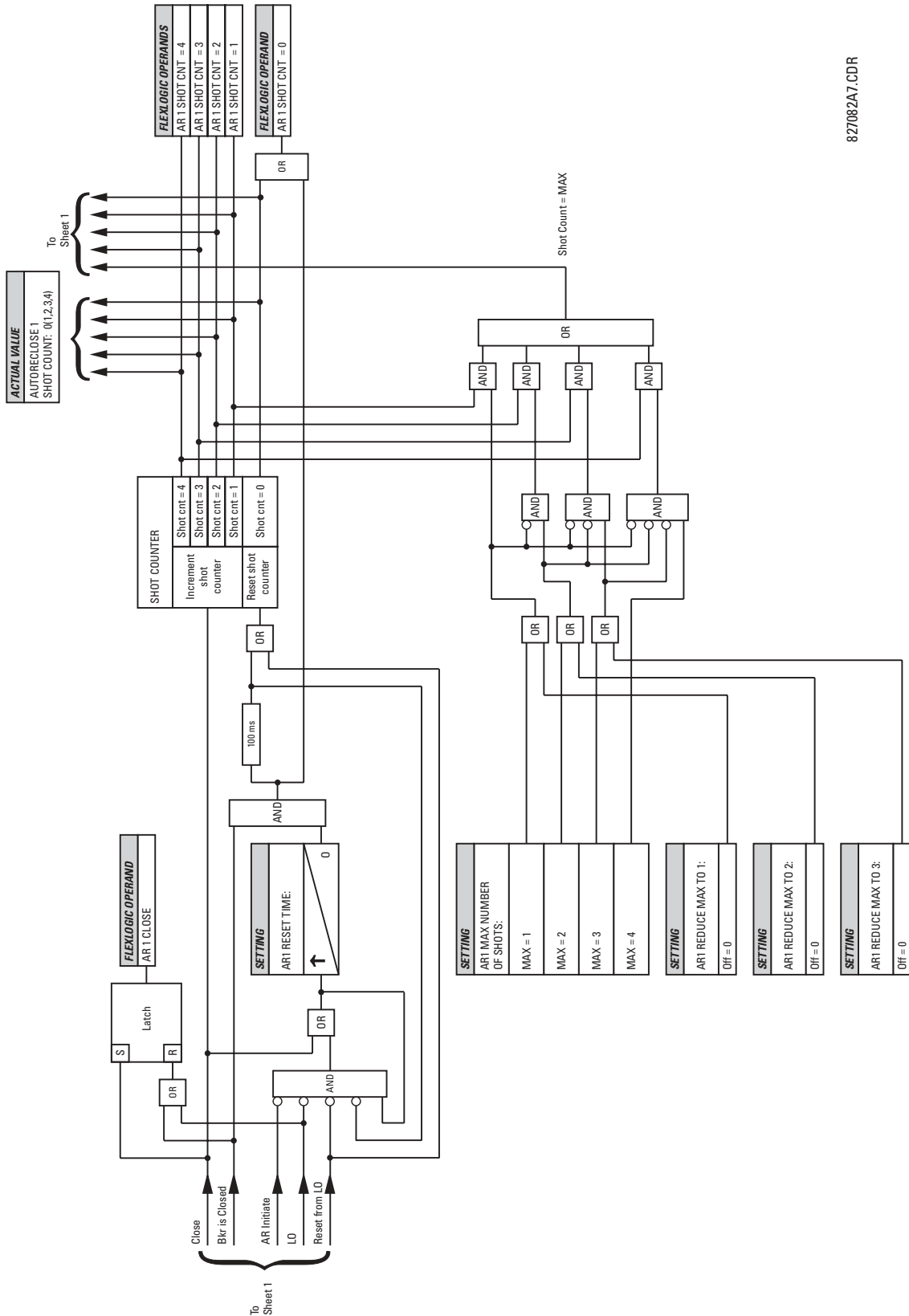

Figure 5-54: AUTORECLOSURE SCHEME LOGIC (Sheet 1 of 2)



827082A7.CDR

Figure 5-55: AUTORECLOSE SCHEME LOGIC (Sheet 2 of 2)

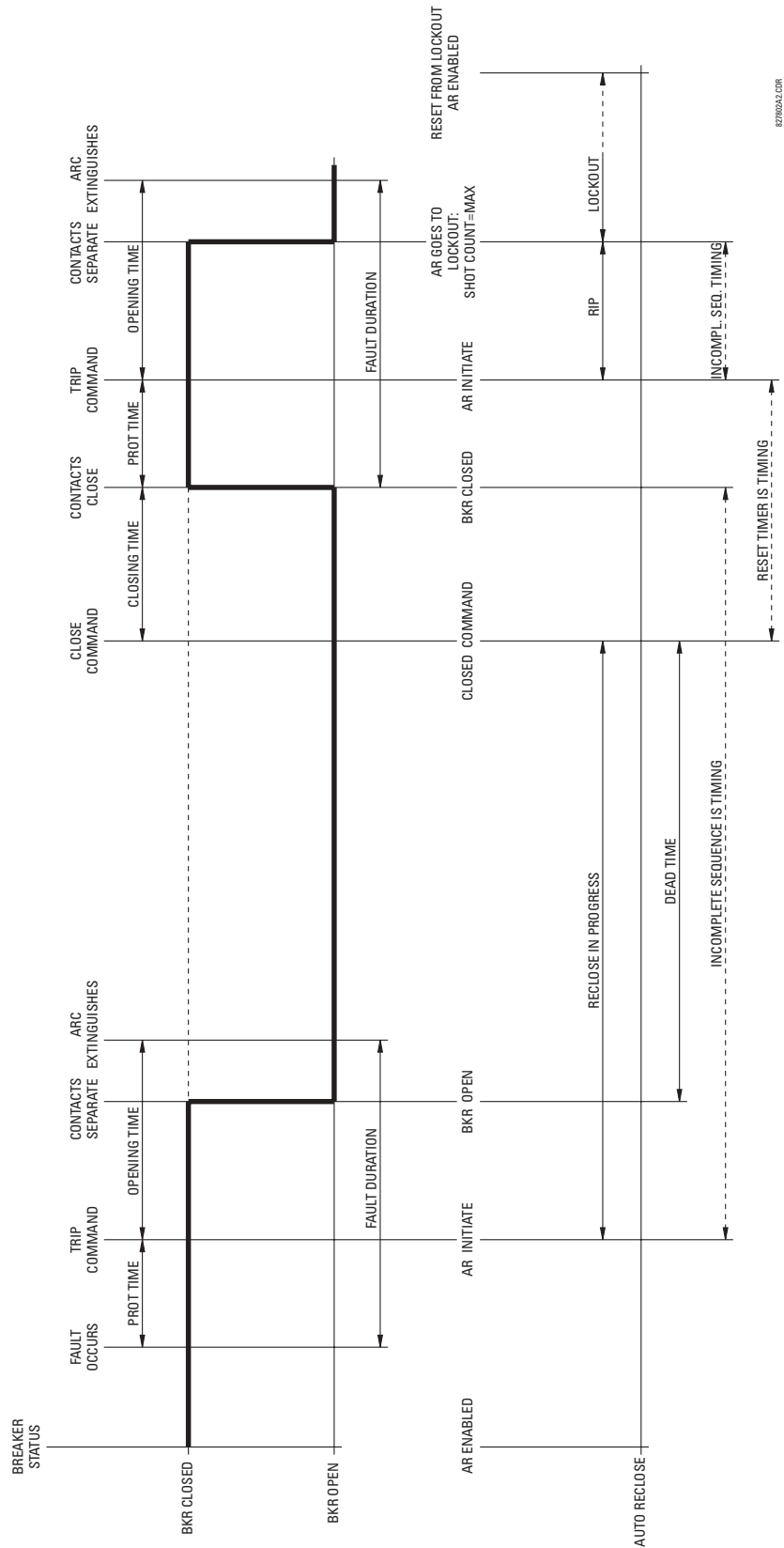

Figure 5-56: SINGLE SHOT AUTORECLOSING SEQUENCE - PERMANENT FAULT

5.6.6 DIGITAL ELEMENTS

PATH: SETTINGS ⇌ CONTROL ELEMENTS ⇌ DIGITAL ELEMENTS ⇌ DIGITAL ELEMENT 1(16)

DIGITAL ELEMENT 1		DIGITAL ELEMENT 1 FUNCTION: Disabled	Range: Disabled, Enabled
MESSAGE	▲▼	DIG ELEM 1 NAME: Dig Element 1	Range: 16 alphanumeric characters
MESSAGE	▲▼	DIG ELEM 1 INPUT: Off	Range: FlexLogic™ operand
MESSAGE	▲▼	DIG ELEM 1 PICKUP DELAY: 0.000 s	Range: 0.000 to 999999.999 s in steps of 0.001
MESSAGE	▲▼	DIG ELEM 1 RESET DELAY: 0.000 s	Range: 0.000 to 999999.999 s in steps of 0.001
MESSAGE	▲▼	DIG ELEM 1 BLOCK: Off	Range: FlexLogic™ operand
MESSAGE	▲▼	DIGITAL ELEMENT 1 TARGET: Self-reset	Range: Self-reset, Latched, Disabled
MESSAGE	▲	DIGITAL ELEMENT 1 EVENTS: Disabled	Range: Disabled, Enabled

5

There are 16 identical Digital Elements available, numbered 1 to 16. A digital element can monitor any FlexLogic™ operand and present a target message and/or enable events recording depending on the output operand state. The digital element settings include a 'name' which will be referenced in any target message, a blocking input from any selected FlexLogic™ operand, and a timer for pickup and reset delays for the output operand.

- **DIGITAL ELEMENT 1 INPUT:** Selects a FlexLogic™ operand to be monitored by the digital element.
- **DIGITAL ELEMENT 1 PICKUP DELAY:** Sets the time delay to pickup. If a pickup delay is not required, set to "0".
- **DIGITAL ELEMENT 1 RESET DELAY:** Sets the time delay to reset. If a reset delay is not required, set to "0".

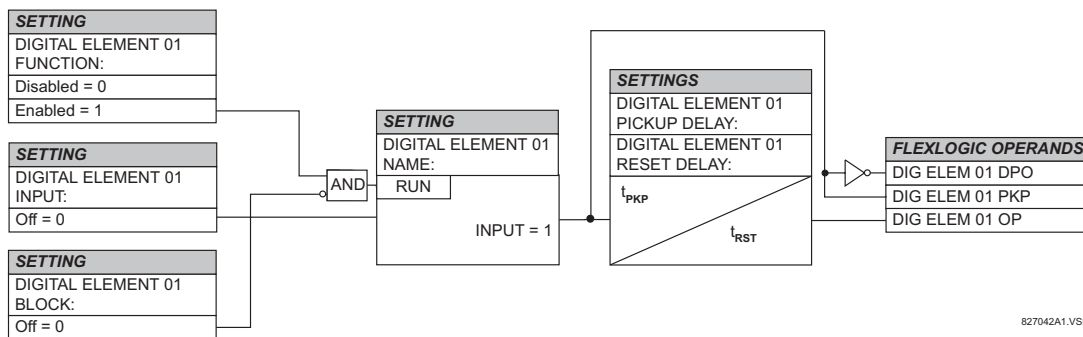

Figure 5-57: DIGITAL ELEMENT SCHEME LOGIC

CIRCUIT MONITORING APPLICATIONS:

Some versions of the digital input modules include an active Voltage Monitor circuit connected across Form-A contacts. The voltage monitor circuit limits the trickle current through the output circuit (see technical specifications for Form-A).

As long as the current through the Voltage Monitor is above a threshold (see technical specifications for Form-A), the Flex-Logic™ operand "Cont Op # VOn" will be set. (# represents the output contact number). If the output circuit has a high resistance or the DC current is interrupted, the trickle current will drop below the threshold and the FlexLogic™ operand "Cont Op # VOff" will be set. Consequently, the state of these operands can be used as indicators of the integrity of the circuits in which Form-A contacts are inserted.

EXAMPLE 1: BREAKER TRIP CIRCUIT INTEGRITY MONITORING

In many applications it is desired to monitor the breaker trip circuit integrity so problems can be detected before a trip operation is required. The circuit is considered to be healthy when the voltage monitor connected across the trip output contact detects a low level of current, well below the operating current of the breaker trip coil. If the circuit presents a high resistance, the trickle current will fall below the monitor threshold and an alarm would be declared.

In most breaker control circuits, the trip coil is connected in series with a breaker auxiliary contact which is open when the breaker is open (see diagram below). To prevent unwanted alarms in this situation, the trip circuit monitoring logic must include the breaker position.

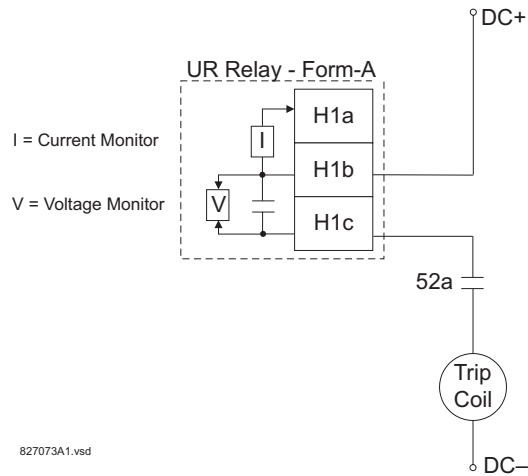

Figure 5-58: TRIP CIRCUIT EXAMPLE 1

Assume the output contact H1 is a trip contact. Using the contact output settings, this output will be given an ID name, e.g. "Cont Op 1". Assume a 52a breaker auxiliary contact is connected to contact input H7a to monitor breaker status. Using the contact input settings, this input will be given an ID name, e.g. "Cont Ip 1" and will be set "On" when the breaker is closed. Using Digital Element 1 to monitor the breaker trip circuit, the settings will be:

■ DIGITAL ELEMENT 1	◀▶	DIGITAL ELEMENT 1 FUNCTION: Enabled
MESSAGE	▲▼	DIG ELEM 1 NAME: Bkr Trip Cct Out
MESSAGE	▲▼	DIG ELEM 1 INPUT: Cont Op 1 VOff
MESSAGE	▲▼	DIG ELEM 1 PICKUP DELAY: 0.200 s
MESSAGE	▲▼	DIG ELEM 1 RESET DELAY: 0.100 s
MESSAGE	▲▼	DIG ELEM 1 BLOCK: Cont Ip 1 Off
MESSAGE	▲▼	DIGITAL ELEMENT 1 TARGET: Self-reset
MESSAGE	▲	DIGITAL ELEMENT 1 EVENTS: Enabled



The PICKUP DELAY setting should be greater than the operating time of the breaker to avoid nuisance alarms.

EXAMPLE 2: BREAKER TRIP CIRCUIT INTEGRITY MONITORING

If it is required to monitor the trip circuit continuously, independent of the breaker position (open or closed), a method to maintain the monitoring current flow through the trip circuit when the breaker is open must be provided (as shown in the figure below). This can be achieved by connecting a suitable resistor (see figure below) across the auxiliary contact in the trip circuit. In this case, it is not required to supervise the monitoring circuit with the breaker position – the **BLOCK** setting is selected to “Off”. In this case, the settings will be:

■ DIGITAL ELEMENT 1	◀▶	DIGITAL ELEMENT 1 FUNCTION: Enabled
MESSAGE	▲▼	DIG ELEM 1 NAME: Bkr Trip Cct Out
MESSAGE	▲▼	DIG ELEM 1 INPUT: Cont Op 1 Voff
MESSAGE	▲▼	DIG ELEM 1 PICKUP DELAY: 0.200 s
MESSAGE	▲▼	DIG ELEM 1 RESET DELAY: 0.100 s
MESSAGE	▲▼	DIG ELEM 1 BLOCK: Off
MESSAGE	▲▼	DIGITAL ELEMENT 1 TARGET: Self-reset
MESSAGE	▲	DIGITAL ELEMENT 1 EVENTS: Enabled

5

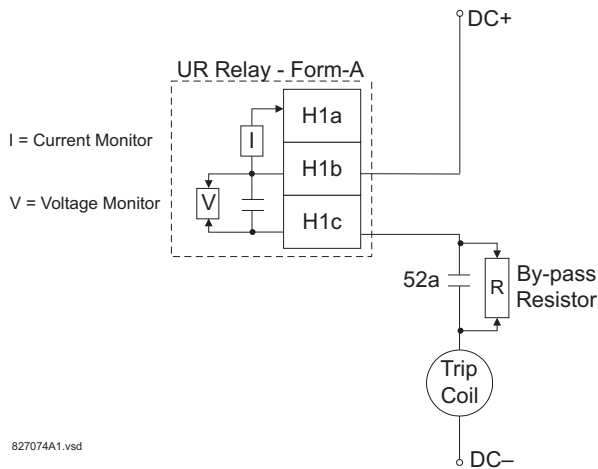

Table 5-17: VALUES OF RESISTOR 'R'

POWER SUPPLY (V DC)	RESISTANCE (OHMS)	POWER (WATTS)
24	1000	2
30	5000	2
48	10000	2
110	25000	5
125	25000	5
250	50000	5

Figure 5-59: TRIP CIRCUIT EXAMPLE 2

5.6.7 DIGITAL COUNTERS

PATH: SETTINGS ⇨ CONTROL ELEMENTS ⇨ DIGITAL COUNTERS ⇨ COUNTER 1(8)

■ COUNTER 1	◀▶	COUNTER 1 FUNCTION: Disabled	Range: Disabled, Enabled
MESSAGE	▲▼	COUNTER 1 NAME: Counter 1	Range: 12 alphanumeric characters
MESSAGE	▲▼	COUNTER 1 UNITS:	Range: 6 alphanumeric characters
MESSAGE	▲▼	COUNTER 1 PRESET: 0	Range: -2,147,483,648 to +2,147,483,647
MESSAGE	▲▼	COUNTER 1 COMPARE: 0	Range: -2,147,483,648 to +2,147,483,647
MESSAGE	▲▼	COUNTER 1 UP: Off	Range: FlexLogic™ operand
MESSAGE	▲▼	COUNTER 1 DOWN: Off	Range: FlexLogic™ operand
MESSAGE	▲▼	COUNTER 1 BLOCK: Off	Range: FlexLogic™ operand
MESSAGE	▲▼	CNT1 SET TO PRESET: Off	Range: FlexLogic™ operand
MESSAGE	▲▼	COUNTER 1 RESET: Off	Range: FlexLogic™ operand
MESSAGE	▲▼	COUNT1 FREEZE/RESET: Off	Range: FlexLogic™ operand
MESSAGE	▲	COUNT1 FREEZE/COUNT: Off	Range: FlexLogic™ operand

There are 8 identical digital counters, numbered from 1 to 8. A digital counter counts the number of state transitions from Logic 0 to Logic 1. The counter is used to count operations such as the pickups of an element, the changes of state of an external contact (e.g. breaker auxiliary switch), or pulses from a watt-hour meter.

- **COUNTER 1 UNITS:** Assigns a label to identify the unit of measure pertaining to the digital transitions to be counted. The units label will appear in the corresponding actual values status.
- **COUNTER 1 PRESET:** Sets the count to a required preset value before counting operations begin, as in the case where a substitute relay is to be installed in place of an in-service relay, or while the counter is running.
- **COUNTER 1 COMPARE:** Sets the value to which the accumulated count value is compared. Three FlexLogic™ output operands are provided to indicate if the present value is 'more than (HI)', 'equal to (EQL)', or 'less than (LO)' the set value.
- **COUNTER 1 UP:** Selects the FlexLogic™ operand for incrementing the counter. If an enabled UP input is received when the accumulated value is at the limit of +2,147,483,647 counts, the counter will rollover to -2,147,483,648.
- **COUNTER 1 DOWN:** Selects the FlexLogic™ operand for decrementing the counter. If an enabled DOWN input is received when the accumulated value is at the limit of -2,147,483,648 counts, the counter will rollover to +2,147,483,647.
- **COUNTER 1 BLOCK:** Selects the FlexLogic™ operand for blocking the counting operation. All counter operands are blocked.

- CNT1 SET TO PRESET:** Selects the FlexLogic™ operand used to set the count to the preset value. The counter will be set to the preset value in the following situations:
 - When the counter is enabled and the **CNT1 SET TO PRESET** operand has the value 1 (when the counter is enabled and **CNT1 SET TO PRESET** operand is 0, the counter will be set to 0).
 - When the counter is running and the **CNT1 SET TO PRESET** operand changes the state from 0 to 1 (**CNT1 SET TO PRESET** changing from 1 to 0 while the counter is running has no effect on the count).
 - When a reset or reset/freeze command is sent to the counter and the **CNT1 SET TO PRESET** operand has the value 1 (when a reset or reset/freeze command is sent to the counter and the **CNT1 SET TO PRESET** operand has the value 0, the counter will be set to 0).
- COUNTER 1 RESET:** Selects the FlexLogic™ operand for setting the count to either “0” or the preset value depending on the state of the **CNT1 SET TO PRESET** operand.
- COUNTER 1 FREEZE/RESET:** Selects the FlexLogic™ operand for capturing (freezing) the accumulated count value into a separate register with the date and time of the operation, and resetting the count to “0”.
- COUNTER 1 FREEZE/COUNT:** Selects the FlexLogic™ operand for capturing (freezing) the accumulated count value into a separate register with the date and time of the operation, and continuing counting. The present accumulated value and captured frozen value with the associated date/time stamp are available as actual values. If control power is interrupted, the accumulated and frozen values are saved into non-volatile memory during the power down operation.

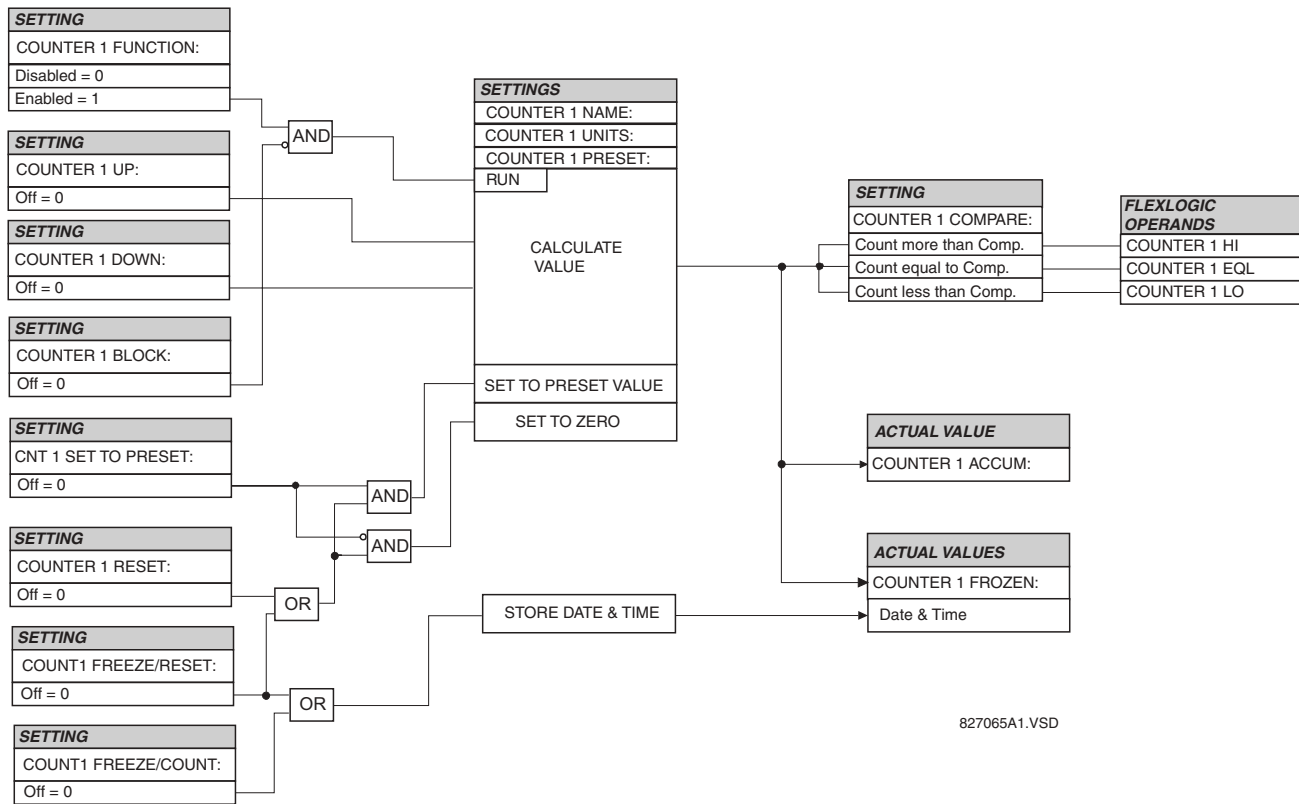









Figure 5-60: DIGITAL COUNTER SCHEME LOGIC

5.6.8 8-BIT SWITCHES

PATH: SETTINGS ⇨ CONTROL ELEMENTS ⇨ 8-BIT SWITCHES ⇨ 8-BIT SWITCH 1(6)

<ul style="list-style-type: none"> ■ 8-BIT ■ SWITCH 1 		8BIT SWITCH 1 FUNCTION: Disabled	Range: Disabled, Enabled
MESSAGE		8BIT SW 1 ARG A0: Off	Range: FlexLogic™ operand
MESSAGE		8BIT SW 1 ARG A1: Off	Range: FlexLogic™ operand
↓			
MESSAGE		8BIT SW 1 ARG A7: Off	Range: FlexLogic™ operand
MESSAGE		8BIT SW 1 ARG B0: Off	Range: FlexLogic™ operand
MESSAGE		8BIT SW 1 ARG B1: Off	Range: FlexLogic™ operand
↓			
MESSAGE		8BIT SW 1 ARG B7: Off	Range: FlexLogic™ operand
MESSAGE		8BIT SW 1 CONTROL: Off	Range: FlexLogic™ operand

This feature allows switching between two input arguments defined by 8 bits each. The bits are specified by FlexLogic™ operands. The feature could be viewed as an integrated two-position switch for 8 logic signals.

Typically this element is applied in conjunction with the Digitizer and 8-bit Comparator features.

- **8BIT SW 1 ARG A0 to 8BIT SW 1 ARG A7:** These settings specify FlexLogic™ operands that constitute the first (A) input of the switch. These operands are routed to the output operands if the control input is in the "Off" position.
- **8BIT SW 1 ARG B0 to 8BIT SW 1 ARG B7:** These settings specify FlexLogic™ operands that constitute the second (B) input of the switch. These operands are routed to the output operands if the control input is in the "On" position.
- **8BIT SW 1 CONTROL:** This setting specifies FlexLogic™ operands to control the routing between the A and B inputs of the switch. If the control operand is in the "Off" state, the first (A) input is switched to the output. If the control operand is in the "On" state, the second (B) input is switched to the output. The switching takes place instantaneously.

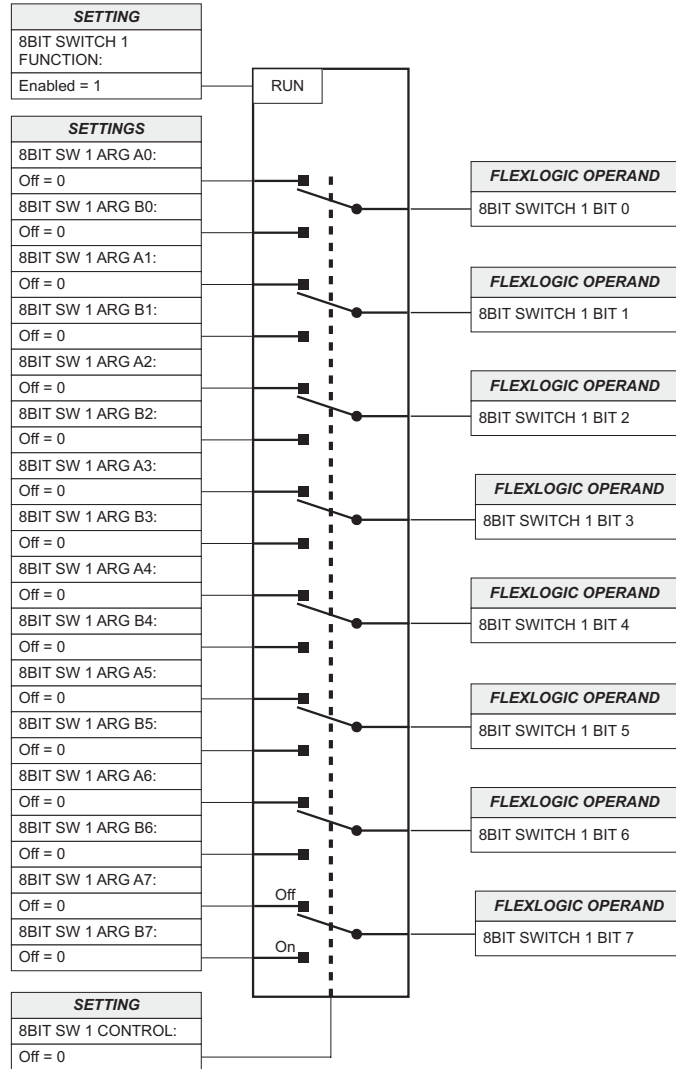

842017A1.CDR

Figure 5-61: 8-BIT SWITCH LOGIC

5.6.9 MONITORING ELEMENTS

a) MAIN MENU

PATH: SETTINGS ⇨ CONTROL ELEMENTS ⇨ MONITORING ELEMENTS

■ MONITORING
■ ELEMENTS



■ BREAKER 1
■ ARCING CURRENT

See page 5-107.

MESSAGE



■ BREAKER 2
■ ARCING CURRENT

See page 5-107.

b) BREAKER ARCING CURRENT

PATH: SETTINGS ⇒ CONTROL ELEMENTS ⇒ MONITORING ELEMENTS ⇒ BREAKER 1(6) ARCING CURRENT

■ BREAKER 1	◀▶	BKR 1 ARC AMP	Range: Disabled, Enabled
■ ARCING CURRENT		FUNCTION: Disabled	
MESSAGE	▲▼	BKR 1 ARC AMP	Range: SRC 1, SRC 2, SRC 3, SRC 4, SRC 5, SRC 6
		SOURCE: SRC 1	
MESSAGE	▲▼	BKR 1 ARC AMP INIT-A:	Range: FlexLogic™ operand
		Off	
MESSAGE	▲▼	BKR 1 ARC AMP INIT-B:	Range: FlexLogic™ operand
		Off	
MESSAGE	▲▼	BKR 1 ARC AMP INIT-C:	Range: FlexLogic™ operand
		Off	
MESSAGE	▲▼	BKR 1 ARC AMP	Range: 0.000 to 65.535 s in steps of 0.001
		DELAY: 0.000 s	
MESSAGE	▲▼	BKR 1 ARC AMP LIMIT:	Range: 0 to 50000 kA ² -cycle in steps of 1
		1000 kA ² -cyc	
MESSAGE	▲▼	BKR 1 ARC AMP BLOCK:	Range: FlexLogic™ operand
		Off	
MESSAGE	▲▼	BKR 1 ARC AMP	Range: Self-reset, Latched, Disabled
		TARGET: Self-reset	
MESSAGE	▲	BKR 1 ARC AMP	Range: Disabled, Enabled
		EVENTS: Disabled	

There is one Breaker Arcing Current element available per CT bank, with a minimum of 2 elements. This element calculates an estimate of the per-phase wear on the breaker contacts by measuring and integrating the current squared passing through the breaker contacts as an arc. These per-phase values are added to accumulated totals for each phase and compared to a programmed threshold value. When the threshold is exceeded in any phase, the relay can set an output operand to "1". The accumulated value for each phase can be displayed as an actual value.

The operation of the scheme is shown in the following logic diagram. The same output operand that is selected to operate the output relay used to trip the breaker, indicating a tripping sequence has begun, is used to initiate this feature. A time delay is introduced between initiation and the starting of integration to prevent integration of current flow through the breaker before the contacts have parted. This interval includes the operating time of the output relay, any other auxiliary relays and the breaker mechanism. For maximum measurement accuracy, the interval between change-of-state of the operand (from 0 to 1) and contact separation should be measured for the specific installation. Integration of the measured current continues for 100 ms, which is expected to include the total arcing period.

The feature is programmed to perform fault duration calculations. Fault duration is defined as a time between operation of the disturbance detector occurring before initiation of this feature, and reset of an internal low-set overcurrent function. Correction is implemented to account for a non-zero reset time of the overcurrent function.

Breaker arcing currents and fault duration values are available under the **ACTUAL VALUES** ⇒ **RECORDS** ⇒ **MAINTENANCE** ⇒ **BREAKER 1(6)** menus.

- **BKR 1(6) ARC AMP INIT-A(C):** Select the same output operands that are configured to operate the output relays used to trip the breaker. In three-pole tripping applications, the same operand should be configured to initiate arcing current calculations for poles A, B and C of the breaker. In single-pole tripping applications, per-pole tripping operands should be configured to initiate the calculations for the poles that are actually tripped.
- **BKR 1(6) ARC AMP DELAY:** This setting is used to program the delay interval between the time the tripping sequence is initiated and the time the breaker contacts are expected to part, starting the integration of the measured current.
- **BKR 1(6) ARC AMP LIMIT:** Selects the threshold value above which the output operand is set.

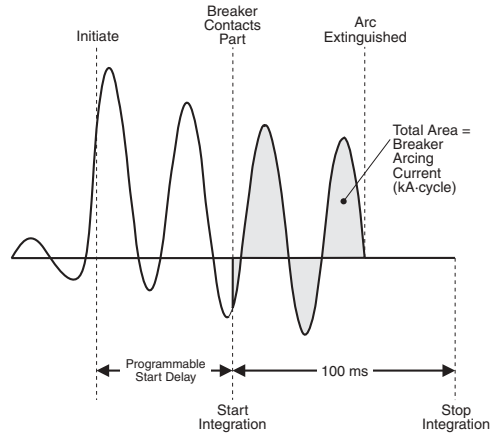

Figure 5-62: ARcing Current Measurement

5

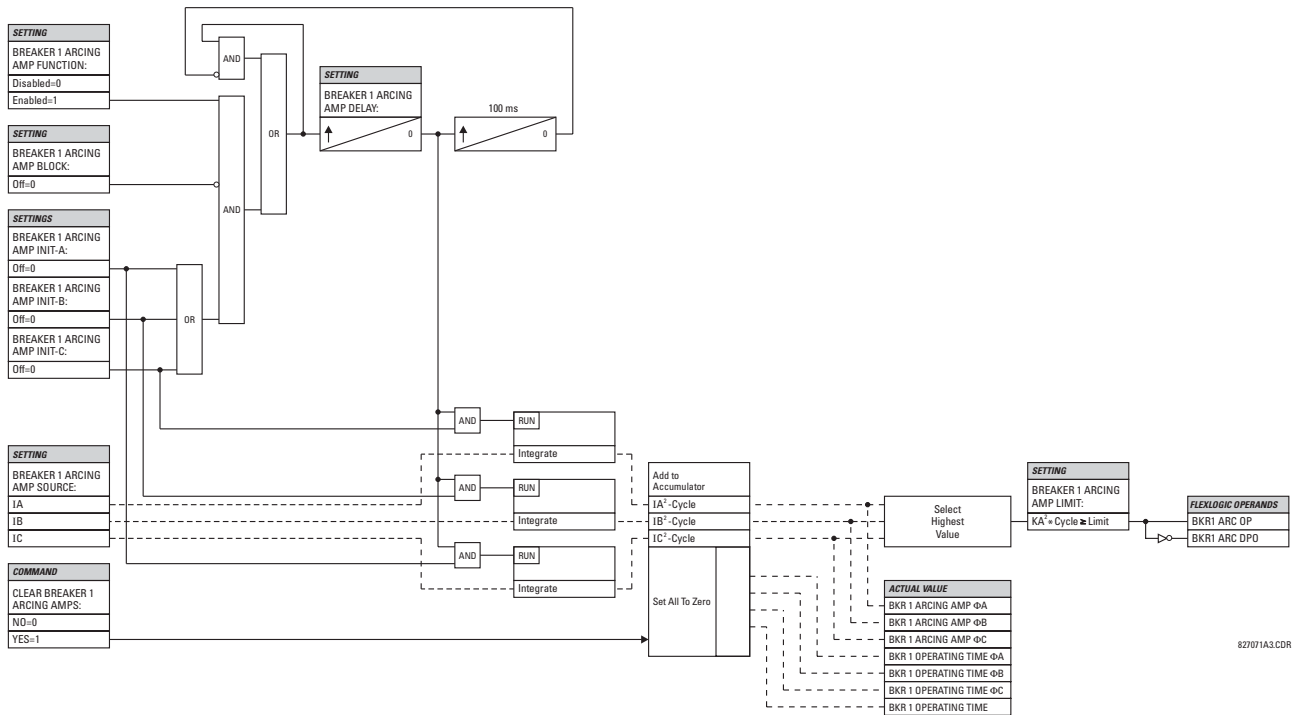
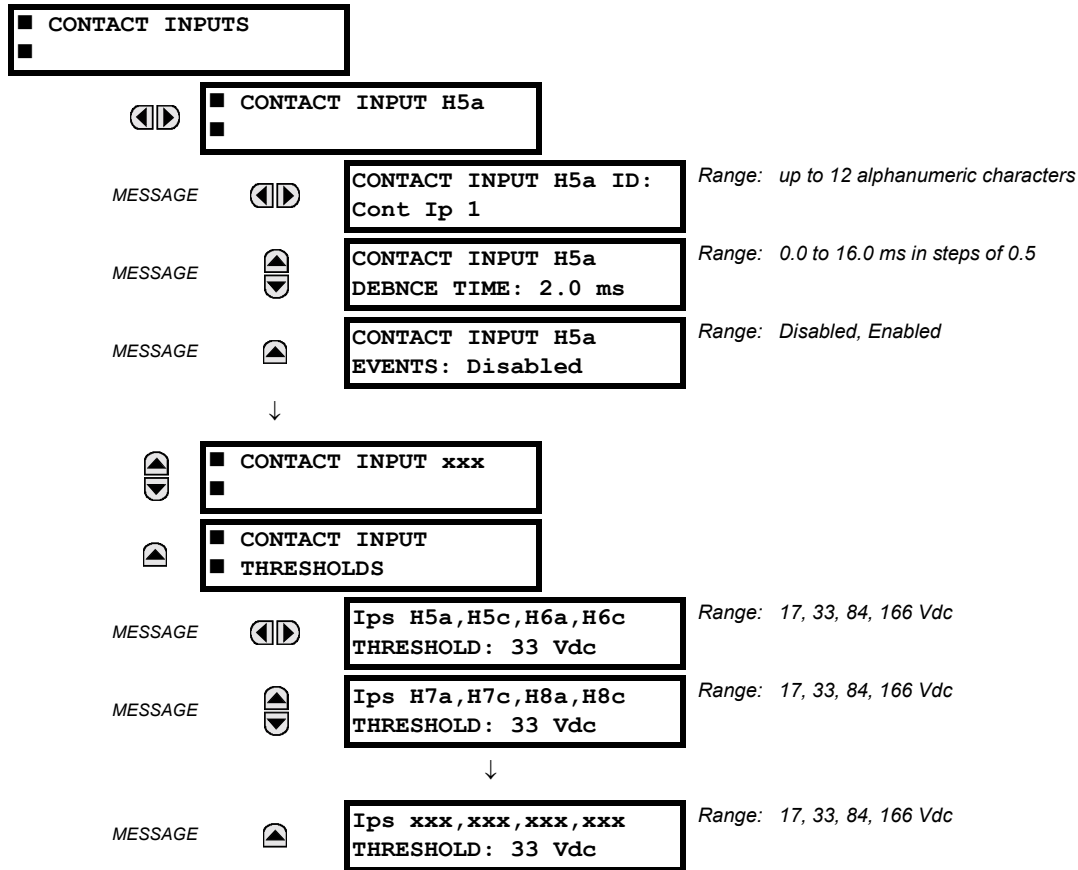

Figure 5-63: Breaker Arcing Current Scheme Logic

5.7.1 CONTACT INPUTS

PATH: SETTINGS ⇒ INPUTS/OUTPUTS ⇒ CONTACT INPUTS



The contact inputs menu contains configuration settings for each contact input as well as voltage thresholds for each group of four contact inputs. Upon startup, the relay processor determines (from an assessment of the installed modules) which contact inputs are available and then display settings for only those inputs.

An alphanumeric ID may be assigned to a contact input for diagnostic, setting, and event recording purposes. The CONTACT IP X On™ (Logic 1) FlexLogic™ operand corresponds to contact input “X” being closed, while CONTACT IP X Off corresponds to contact input “X” being open. The **CONTACT INPUT DEBNCE TIME** defines the time required for the contact to overcome ‘contact bouncing’ conditions. As this time differs for different contact types and manufacturers, set it as a maximum contact debounce time (per manufacturer specifications) plus some margin to ensure proper operation. If **CONTACT INPUT EVENTS** is set to “Enabled”, every change in the contact input state will trigger an event.

A raw status is scanned for all Contact Inputs synchronously at the constant rate of 0.5 ms as shown in the figure below. The DC input voltage is compared to a user-settable threshold. A new contact input state must be maintained for a user-settable debounce time in order for the F35 to validate the new contact state. In the figure below, the debounce time is set at 2.5 ms; thus the 6th sample in a row validates the change of state (mark no. 1 in the diagram). Once validated (debounced), the contact input asserts a corresponding FlexLogic™ operand and logs an event as per user setting.

A time stamp of the first sample in the sequence that validates the new state is used when logging the change of the contact input into the Event Recorder (mark no. 2 in the diagram).

Protection and control elements, as well as FlexLogic™ equations and timers, are executed eight times in a power system cycle. The protection pass duration is controlled by the frequency tracking mechanism. The FlexLogic™ operand reflecting the debounced state of the contact is updated at the protection pass following the validation (marks no. 3 and 4 on the figure below). The update is performed at the beginning of the protection pass so all protection and control functions, as well as FlexLogic™ equations, are fed with the updated states of the contact inputs.

The FlexLogic™ operand response time to the contact input change is equal to the debounce time setting plus up to one protection pass (variable and depending on system frequency if frequency tracking enabled). If the change of state occurs just after a protection pass, the recognition is delayed until the subsequent protection pass; that is, by the entire duration of the protection pass. If the change occurs just prior to a protection pass, the state is recognized immediately. Statistically a delay of half the protection pass is expected. Owing to the 0.5 ms scan rate, the time resolution for the input contact is below 1msec.

For example, 8 protection passes per cycle on a 60 Hz system correspond to a protection pass every 2.1 ms. With a contact debounce time setting of 3.0 ms, the FlexLogic™ operand-assert time limits are: $3.0 + 0.0 = 3.0$ ms and $3.0 + 2.1 = 5.1$ ms. These time limits depend on how soon the protection pass runs after the debouncing time.

Regardless of the contact debounce time setting, the contact input event is time-stamped with a 1 μs accuracy using the time of the first scan corresponding to the new state (mark no. 2 below). Therefore, the time stamp reflects a change in the DC voltage across the contact input terminals that was not accidental as it was subsequently validated using the debounce timer. Keep in mind that the associated FlexLogic™ operand is asserted/de-asserted later, after validating the change.

The debounce algorithm is symmetrical: the same procedure and debounce time are used to filter the LOW-HIGH (marks no.1, 2, 3, and 4 in the figure below) and HIGH-LOW (marks no. 5, 6, 7, and 8 below) transitions.

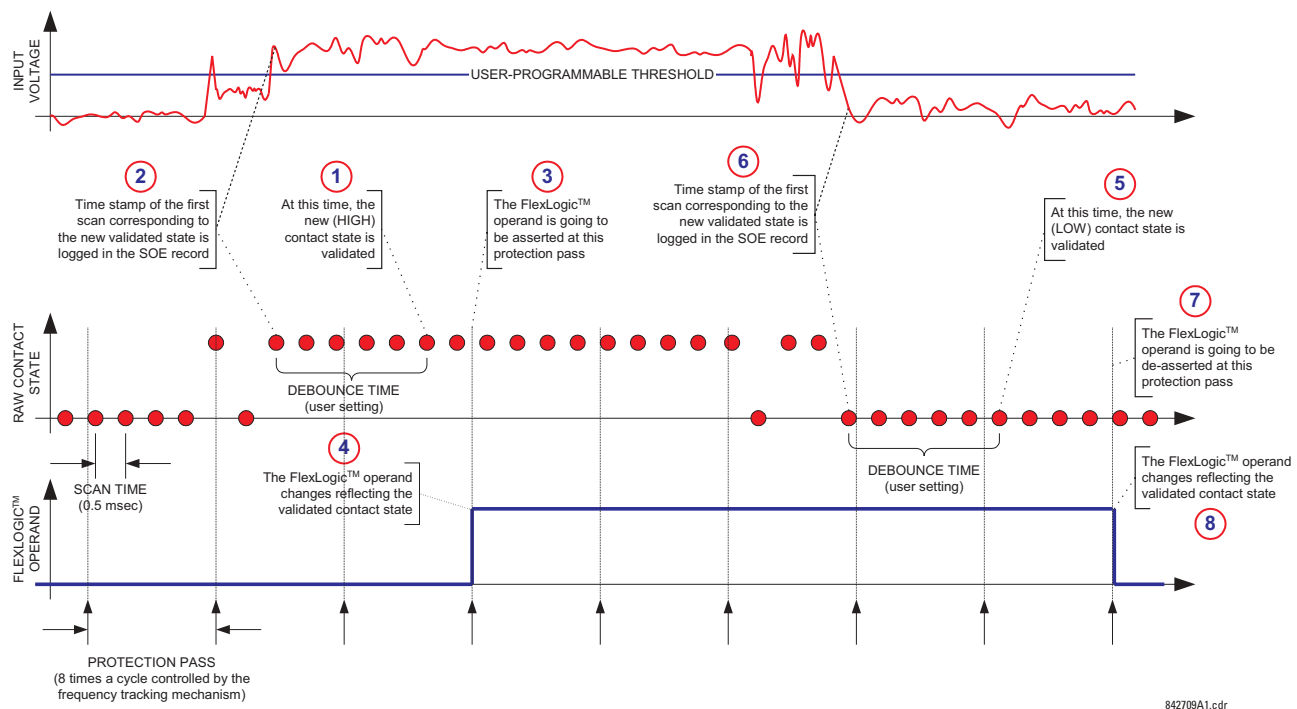

Figure 5-64: INPUT CONTACT DEBOUNCING MECHANISM AND TIME-STAMPING SAMPLE TIMING

Contact inputs are isolated in groups of four to allow connection of wet contacts from different voltage sources for each group. The **CONTACT INPUT THRESHOLDS** determine the minimum voltage required to detect a closed contact input. This value should be selected according to the following criteria: 17 for 24 V sources, 33 for 48 V sources, 84 for 110 to 125 V sources and 166 for 250 V sources.

For example, to use contact input H5a as a status input from the breaker 52b contact to seal-in the trip relay and record it in the Event Records menu, make the following settings changes:

CONTACT INPUT H5A ID: "Breaker Closed (52b)"

CONTACT INPUT H5A EVENTS: "Enabled"

Note that the 52b contact is closed when the breaker is open and open when the breaker is closed.

5.7.2 VIRTUAL INPUTS

PATH: SETTINGS ⇨ INPUTS/OUTPUTS ⇨ VIRTUAL INPUTS ⇨ VIRTUAL INPUT 1(32)

<p>■ VIRTUAL INPUT 1</p> <p>MESSAGE</p> <p>MESSAGE</p> <p>MESSAGE</p>	<p>◀▶</p> <p>▲▼</p> <p>▲▼</p> <p>▲</p>	<p>VIRTUAL INPUT 1 FUNCTION: Disabled</p> <p>VIRTUAL INPUT 1 ID: Virt Ip 1</p> <p>VIRTUAL INPUT 1 TYPE: Latched</p> <p>VIRTUAL INPUT 1 EVENTS: Disabled</p>	<p>Range: Disabled, Enabled</p> <p>Range: Up to 12 alphanumeric characters</p> <p>Range: Self-Reset, Latched</p> <p>Range: Disabled, Enabled</p>
---	--	---	--

There are 32 virtual inputs that can be individually programmed to respond to input signals from the keypad (Commands menu) and communications protocols. All virtual input operands are defaulted to OFF = 0 unless the appropriate input signal is received. **Virtual input states are preserved through a control power loss.**

If the **VIRTUAL INPUT x FUNCTION** is to “Disabled”, the input will be forced to 'Off' (Logic 0) regardless of any attempt to alter the input. If set to “Enabled”, the input operates as shown on the logic diagram and generates output FlexLogic™ operands in response to received input signals and the applied settings.

There are two types of operation: Self-Reset and Latched. If **VIRTUAL INPUT x TYPE** is “Self-Reset”, when the input signal transits from OFF = 0 to ON = 1, the output operand will be set to ON = 1 for only one evaluation of the FlexLogic™ equations and then return to OFF = 0. If set to “Latched”, the virtual input sets the state of the output operand to the same state as the most recent received input, ON =1 or OFF = 0.



The “Self-Reset” operating mode generates the output operand for a single evaluation of the FlexLogic™ equations. If the operand is to be used anywhere other than internally in a FlexLogic™ equation, it will likely have to be lengthened in time. A FlexLogic™ timer with a delayed reset can perform this function.

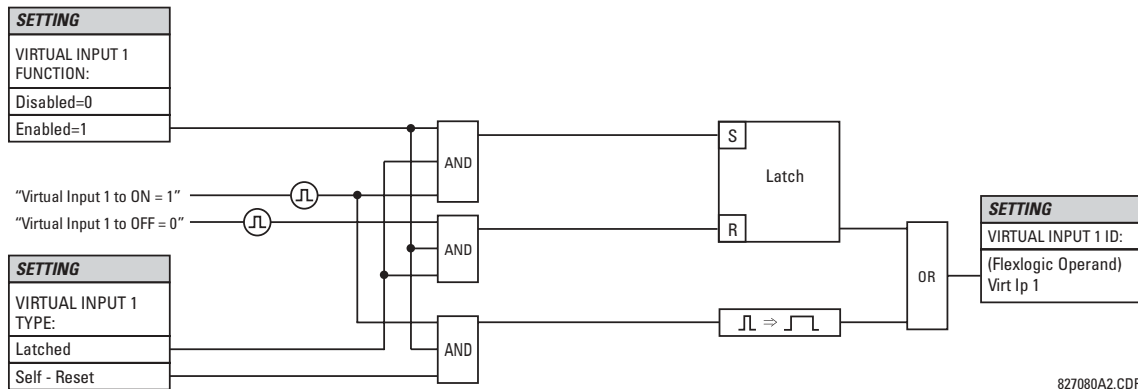

Figure 5-65: VIRTUAL INPUTS SCHEME LOGIC

5.7.3 CONTACT OUTPUTS

PATH: SETTINGS ⇨ INPUTS/OUTPUTS ⇨ CONTACT OUTPUTS ⇨ CONTACT OUTPUT H1

■ CONTACT OUTPUT H1	◀▶	CONTACT OUTPUT H1 ID Cont Op 1	Range: Up to 12 alphanumeric characters
MESSAGE	▲▼	OUTPUT H1 OPERATE: Off	Range: FlexLogic™ operand
MESSAGE	▲▼	OUTPUT H1 SEAL-IN: Off	Range: FlexLogic™ operand
MESSAGE	▲	CONTACT OUTPUT H1 EVENTS: Enabled	Range: Disabled, Enabled

Upon startup of the relay, the main processor will determine from an assessment of the modules installed in the chassis which contact outputs are available and present the settings for only these outputs.

An ID may be assigned to each contact output. The signal that can **OPERATE** a contact output may be any FlexLogic™ operand (virtual output, element state, contact input, or virtual input). An additional FlexLogic™ operand may be used to **SEAL-IN** the relay. Any change of state of a contact output can be logged as an Event if programmed to do so.

For example, the trip circuit current is monitored by providing a current threshold detector in series with some Form-A contacts (see the trip circuit example in the *Digital Elements* section). The monitor will set a flag (see the specifications for Form-A). The name of the FlexLogic™ operand set by the monitor, consists of the output relay designation, followed by the name of the flag; e.g. 'Cont Op 1 IOn' or 'Cont Op 1 IOff'.

In most breaker control circuits, the trip coil is connected in series with a breaker auxiliary contact used to interrupt current flow after the breaker has tripped, to prevent damage to the less robust initiating contact. This can be done by monitoring an auxiliary contact on the breaker which opens when the breaker has tripped, but this scheme is subject to incorrect operation caused by differences in timing between breaker auxiliary contact change-of-state and interruption of current in the trip circuit. The most dependable protection of the initiating contact is provided by directly measuring current in the tripping circuit, and using this parameter to control resetting of the initiating relay. This scheme is often called 'trip seal-in'.

This can be realized in the F35 using the 'Cont Op 1 IOn' FlexLogic™ operand to seal-in the contact output as follows:

CONTACT OUTPUT H1 ID: "Cont Op 1"
 OUTPUT H1 OPERATE: *any suitable FlexLogic™ operand*
 OUTPUT H1 SEAL-IN: "Cont Op 1 IOn"
 CONTACT OUTPUT H1 EVENTS: "Enabled"

5.7.4 LATCHING OUTPUTS

PATH: SETTINGS ⇨ INPUTS/OUTPUTS ⇨ LATCHING OUTPUTS ⇨ LATCHING OUTPUT H1a

■ LATCHING	◀▶	OUTPUT H1a ID L-Cont Op 1	Range: Up to 12 alphanumeric characters
■ OUTPUT H1a	▲▼	OUTPUT H1a OPERATE: Off	Range: FlexLogic™ operand
MESSAGE	▲▼	OUTPUT H1a RESET: Off	Range: FlexLogic™ operand
MESSAGE	▲▼	OUTPUT H1a TYPE: Operate-dominant	Range: Operate-dominant, Reset-dominant
MESSAGE	▲	OUTPUT H1a EVENTS: Disabled	Range: Disabled, Enabled

The F35 latching output contacts are mechanically bi-stable and controlled by two separate (open and close) coils. As such they retain their position even if the relay is not powered up. The relay recognizes all latching output contact cards and populates the setting menu accordingly. On power up, the relay reads positions of the latching contacts from the hardware before executing any other functions of the relay (such as protection and control features or FlexLogic™).

The latching output modules, either as a part of the relay or as individual modules, are shipped from the factory with all latching contacts opened. It is highly recommended to double-check the programming and positions of the latching contacts when replacing a module.

Since the relay asserts the output contact and reads back its position, it is possible to incorporate self-monitoring capabilities for the latching outputs. If any latching outputs exhibits a discrepancy, the **LATCHING OUTPUT ERROR** self-test error is declared. The error is signaled by the **LATCHING OUT ERROR** FlexLogic™ operand, event, and target message.

- **OUTPUT H1a OPERATE:** This setting specifies a FlexLogic™ operand to operate the ‘close coil’ of the contact. The relay will seal-in this input to safely close the contact. Once the contact is closed and the **RESET** input is logic 0 (off), any activity of the **OPERATE** input, such as subsequent chattering, will not have any effect. With both the **OPERATE** and **RESET** inputs active (logic 1), the response of the latching contact is specified by the **OUTPUT H1A TYPE** setting.
- **OUTPUT H1a RESET:** This setting specifies a FlexLogic™ operand to operate the ‘trip coil’ of the contact. The relay will seal-in this input to safely open the contact. Once the contact is opened and the **OPERATE** input is logic 0 (off), any activity of the **RESET** input, such as subsequent chattering, will not have any effect. With both the **OPERATE** and **RESET** inputs active (logic 1), the response of the latching contact is specified by the **OUTPUT H1A TYPE** setting.
- **OUTPUT H1a TYPE:** This setting specifies the contact response under conflicting control inputs; that is, when both the **OPERATE** and **RESET** signals are applied. With both control inputs applied simultaneously, the contact will close if set to “Operate-dominant” and will open if set to “Reset-dominant”.

Application Example 1:

A latching output contact H1a is to be controlled from two user-programmable pushbuttons (buttons number 1 and 2). The following settings should be applied.

Program the Latching Outputs by making the following changes in the **SETTINGS** ⇒ **INPUTS/OUTPUT** ⇒ **LATCHING OUTPUTS** ⇒ **LATCHING OUTPUT H1a** menu (assuming an H4L module):

OUTPUT H1a OPERATE: “PUSHBUTTON 1 ON”
OUTPUT H1a RESET: “PUSHBUTTON 2 ON”

Program the pushbuttons by making the following changes in the **PRODUCT SETUP** ⇒ **USER-PROGRAMMABLE PUSHBUTTONS** ⇒ **USER PUSHBUTTON 1** and **USER PUSHBUTTON 2** menus:

PUSHBUTTON 1 FUNCTION: “Self-reset”
PUSHBTN 1 DROP-OUT TIME: “0.00 s”

PUSHBUTTON 2 FUNCTION: “Self-reset”
PUSHBTN 2 DROP-OUT TIME: “0.00 s”

Application Example 2:

A relay, having two latching contacts H1a and H1c, is to be programmed. The H1a contact is to be a Type-a contact, while the H1c contact is to be a Type-b contact (Type-a means closed after exercising the operate input; Type-b means closed after exercising the reset input). The relay is to be controlled from virtual outputs: VO1 to operate and VO2 to reset.

Program the Latching Outputs by making the following changes in the **SETTINGS** ⇒ **INPUTS/OUTPUT** ⇒ **LATCHING OUTPUTS** ⇒ **LATCHING OUTPUT H1a** and **LATCHING OUTPUT H1c** menus (assuming an H4L module):

OUTPUT H1a OPERATE: “VO1”
OUTPUT H1a RESET: “VO2”

OUTPUT H1c OPERATE: “VO2”
OUTPUT H1c RESET: “VO1”

Since the two physical contacts in this example are mechanically separated and have individual control inputs, they will not operate at exactly the same time. A discrepancy in the range of a fraction of a maximum operating time may occur. Therefore, a pair of contacts programmed to be a multi-contact relay will not guarantee any specific sequence of operation (such as make before break). If required, the sequence of operation must be programmed explicitly by delaying some of the control inputs as shown in the next application example.

Application Example 3:

A make before break functionality must be added to the preceding example. An overlap of 20 ms is required to implement this functionality as described below:

Write the following FlexLogic™ equation (enerVista UR Setup example shown):

FLEXLOGIC ENTRY	TYPE	SYNTAX
View Graphic	View	View
FlexLogic Entry 1	Read Virtual Outputs On	Virt Op 1 On (VO1)
FlexLogic Entry 2	TIMER	Timer 1
FlexLogic Entry 3	Write Virtual Output[Assign]	= Virt Op 3 (VO3)
FlexLogic Entry 4	Read Virtual Outputs On	Virt Op 2 On (VO2)
FlexLogic Entry 5	TIMER	Timer 2
FlexLogic Entry 6	Write Virtual Output[Assign]	= Virt Op 4 (VO4)
FlexLogic Entry 7	End of List	

Both timers (Timer 1 and Timer 2) should be set to 20 ms pickup and 0 ms dropout.

Program the Latching Outputs by making the following changes in the **SETTINGS** ⇒ **INPUTS/OUTPUT** ⇒ **LATCHING OUTPUTS** ⇒ **LATCHING OUTPUT H1a** and **LATCHING OUTPUT H1c** menus (assuming an H4L module):

OUTPUT H1a OPERATE: "VO1"
OUTPUT H1a RESET: "VO4"

OUTPUT H1c OPERATE: "VO2"
OUTPUT H1c RESET: "VO3"

Application Example 4:

A latching contact H1a is to be controlled from a single virtual output VO1. The contact should stay closed as long as VO1 is high, and should stay opened when VO1 is low. Program the relay as follows.

Write the following FlexLogic™ equation (enerVista UR Setup example shown):

FLEXLOGIC ENTRY	TYPE	SYNTAX
View Graphic	View	View
FlexLogic Entry 1	Read Virtual Outputs On	Virt Op 1 On (VO1)
FlexLogic Entry 2	NOT	1 Input
FlexLogic Entry 3	Write Virtual Output[Assign]	= Virt Op 2 (VO2)
FlexLogic Entry 4	End of List	

Program the Latching Outputs by making the following changes in the **SETTINGS** ⇒ **INPUTS/OUTPUT** ⇒ **LATCHING OUTPUTS** ⇒ **LATCHING OUTPUT H1a** menu (assuming an H4L module):

OUTPUT H1a OPERATE: "VO1"
OUTPUT H1a RESET: "VO2"

5.7.5 VIRTUAL OUTPUTS

PATH: **SETTINGS** ⇒ **INPUTS/OUTPUTS** ⇒ **VIRTUAL OUTPUTS** ⇒ **VIRTUAL OUTPUT 1(64)**

VIRTUAL OUTPUT 1

MESSAGE

◀ ▶

▲

VIRTUAL OUTPUT 1 ID

Virt Op 1

Range: Up to 12 alphanumeric characters

VIRTUAL OUTPUT 1

EVENTS: Disabled

Range: Disabled, Enabled

There are 64 virtual outputs that may be assigned via FlexLogic™. If not assigned, the output will be forced to 'OFF' (Logic 0). An ID may be assigned to each virtual output. Virtual outputs are resolved in each pass through the evaluation of the FlexLogic™ equations. Any change of state of a virtual output can be logged as an event if programmed to do so.

For example, if Virtual Output 1 is the trip signal from FlexLogic™ and the trip relay is used to signal events, the settings would be programmed as follows:

VIRTUAL OUTPUT 1 ID: "Trip"
VIRTUAL OUTPUT 1 EVENTS: "Disabled"

5.7.6 REMOTE DEVICES

a) REMOTE INPUTS/OUTPUTS OVERVIEW

Remote inputs and outputs, which are a means of exchanging information regarding the state of digital points between remote devices, are provided in accordance with the IEC 61850 “Generic Object Oriented Substation Event (GSSE)” specifications.



The IEC 61850 specification requires that communications between devices be implemented on Ethernet communications facilities. For UR-series relays, Ethernet communications is provided only on the type 9G and 9H versions of the CPU module.

The sharing of digital point state information between GSSE equipped relays is essentially an extension to FlexLogic™ to allow distributed FlexLogic™ by making operands available to/from devices on a common communications network. In addition to digital point states, GSSE messages identify the originator of the message and provide other information required by the communication specification. All devices listen to network messages and capture data from only those messages that have originated in selected devices.

GSSE messages are designed to be short, high priority and with a high level of reliability. The GSSE message structure contains space for 128 bit pairs representing digital point state information. The IEC 61850 specification provides 32 “DNA” bit pairs, which are status bits representing pre-defined events. All remaining bit pairs are “UserSt” bit pairs, which are status bits representing user-definable events. The F35 implementation provides 32 of the 96 available UserSt bit pairs.

The IEC 61850 specification includes features that are used to cope with the loss of communication between transmitting and receiving devices. Each transmitting device will send a GSSE message upon a successful power-up, when the state of any included point changes, or after a specified interval (the ‘default update’ time) if a change-of-state has not occurred. The transmitting device also sends a ‘hold time’ which is set to three times the programmed default time, which is required by the receiving device.

Receiving devices are constantly monitoring the communications network for messages they require, as recognized by the identification of the originating device carried in the message. Messages received from remote devices include the message ‘hold’ time for the device. The receiving relay sets a timer assigned to the originating device to the ‘hold’ time interval, and if it has not received another message from this device at time-out, the remote device is declared to be non-communicating, so it will use the programmed default state for all points from that specific remote device. This mechanism allows a receiving device to fail to detect a single transmission from a remote device which is sending messages at the slowest possible rate, as set by its ‘default update’ timer, without reverting to use of the programmed default states. If a message is received from a remote device before the ‘hold’ time expires, all points for that device are updated to the states contained in the message and the hold timer is restarted. The status of a remote device, where “Offline” indicates non-communicating, can be displayed.

The GSSE facility provides for 32 remote inputs and 64 remote outputs.

b) LOCAL DEVICES: ID OF DEVICE FOR TRANSMITTING GSSE MESSAGES

In a F35 relay, the device ID that identifies the originator of the message is programmed in the **SETTINGS** ⇒ **PRODUCT SETUP** ⇒ **INSTALLATION** ⇒ **RELAY NAME** setting.

c) REMOTE DEVICES: ID OF DEVICE FOR RECEIVING GSSE MESSAGES

PATH: **SETTINGS** ⇒ **INPUTS/OUTPUTS** ⇒ **REMOTE DEVICES** ⇒ **REMOTE DEVICE 1(16)**

■ REMOTE DEVICE 1 ■	◀▶	REMOTE DEVICE 1 ID: Remote Device 1	<i>Range: up to 20 alphanumeric characters</i>
------------------------	----	--	--

Sixteen remote devices, numbered from 1 to 16, can be selected for setting purposes. A receiving relay must be programmed to capture messages from only those originating remote devices of interest. This setting is used to select specific remote devices by entering (bottom row) the exact identification (ID) assigned to those devices.

5.7.7 REMOTE INPUTS

PATH: SETTINGS ⇨ INPUTS/OUTPUTS ⇨ REMOTE INPUTS ⇨ REMOTE INPUT 1(32)

■ REMOTE INPUT 1	◀▶	REMOTE IN 1 DEVICE: Remote Device 1	Range: 1 to 16 inclusive
MESSAGE	▲▼	REMOTE IN 1 BIT PAIR: None	Range: None, DNA-1 to DNA-32, UserSt-1 to UserSt-32
MESSAGE	▲▼	REMOTE IN 1 DEFAULT STATE: Off	Range: On, Off, Latest/On, Latest/Off
MESSAGE	▲	REMOTE IN 1 EVENTS: Disabled	Range: Disabled, Enabled

Remote Inputs which create FlexLogic™ operands at the receiving relay, are extracted from GSSE messages originating in remote devices. The relay provides 32 remote inputs, each of which can be selected from a list consisting of 64 selections: DNA-1 through DNA-32 and UserSt-1 through UserSt-32. The function of DNA inputs is defined in the IEC 61850 specification and is presented in the IEC 61850 DNA Assignments table in the *Remote Outputs* section. The function of UserSt inputs is defined by the user selection of the FlexLogic™ operand whose state is represented in the GSSE message. A user must program a DNA point from the appropriate FlexLogic™ operand.

Remote Input 1 must be programmed to replicate the logic state of a specific signal from a specific remote device for local use. This programming is performed via the three settings shown above.

REMOTE IN 1 DEVICE selects the number (1 to 16) of the remote device which originates the required signal, as previously assigned to the remote device via the setting **REMOTE DEVICE NN ID** (see the *Remote Devices* section). **REMOTE IN 1 BIT PAIR** selects the specific bits of the GSSE message required.

The **REMOTE IN 1 DEFAULT STATE** setting selects the logic state for this point if the local relay has just completed startup or the remote device sending the point is declared to be non-communicating. The following choices are available:

- Setting **REMOTE IN 1 DEFAULT STATE** to “On” value defaults the input to Logic 1.
- Setting **REMOTE IN 1 DEFAULT STATE** to “Off” value defaults the input to Logic 0.
- Setting **REMOTE IN 1 DEFAULT STATE** to “Latest/On” freezes the input in case of lost communications. If the latest state is not known, such as after relay power-up but before the first communication exchange, the input will default to Logic 1. When communication resumes, the input becomes fully operational.
- Setting **REMOTE IN 1 DEFAULT STATE** to “Latest/Off” freezes the input in case of lost communications. If the latest state is not known, such as after relay power-up but before the first communication exchange, the input will default to Logic 0. When communication resumes, the input becomes fully operational.



NOTE

For additional information on the GSSE specification, refer to the *Remote Devices* section in this chapter.

5.7.8 REMOTE OUTPUTS

a) DNA BIT PAIRS

PATH: SETTINGS ⇨ INPUTS/OUTPUTS ⇨ REMOTE OUTPUTS DNA BIT PAIRS ⇨ REMOTE OUPUTS DNA- 1(32) BIT PAIR

■ REMOTE OUTPUTS

■ DNA- 1 BIT PAIR

MESSAGE

▲

DNA- 1 OPERAND:

Off

Range: FlexLogic™ Operand

DNA- 1 EVENTS:

Disabled

Range: Disabled, Enabled

Remote Outputs (1 to 32) are FlexLogic™ operands inserted into GSSE messages that are transmitted to remote devices on a LAN. Each digital point in the message must be programmed to carry the state of a specific FlexLogic™ operand. The above operand setting represents a specific DNA function (as shown in the following table) to be transmitted.

Table 5–18: IEC 61850 DNA2 ASSIGNMENTS

DNA	DEFINITION	INTENDED FUNCTION	LOGIC 0	LOGIC 1
1	OperDev		Trip	Close
2	Lock Out		LockoutOff	LockoutOn
3	Initiate Reclosing	Initiate remote reclose sequence	InitRecloseOff	InitRecloseOn
4	Block Reclosing	Prevent/cancel remote reclose sequence	BlockOff	BlockOn
5	Breaker Failure Initiate	Initiate remote breaker failure scheme	BFIOff	BFION
6	Send Transfer Trip	Initiate remote trip operation	TxXfrTripOff	TxXfrTripOn
7	Receive Transfer Trip	Report receipt of remote transfer trip command	RxXfrTripOff	RxXfrTripOn
8	Send Perm	Report permissive affirmative	TxPermOff	TxPermOn
9	Receive Perm	Report receipt of permissive affirmative	RxPermOff	RxPermOn
10	Stop Perm	Override permissive affirmative	StopPermOff	StopPermOn
11	Send Block	Report block affirmative	TxBlockOff	TxBlockOn
12	Receive Block	Report receipt of block affirmative	RxBlockOff	RxBlockOn
13	Stop Block	Override block affirmative	StopBlockOff	StopBlockOn
14	BkrDS	Report breaker disconnect 3-phase state	Open	Closed
15	BkrPhsADS	Report breaker disconnect phase A state	Open	Closed
16	BkrPhsBDS	Report breaker disconnect phase B state	Open	Closed
17	BkrPhsCDS	Report breaker disconnect phase C state	Open	Closed
18	DiscSwDS		Open	Closed
19	Interlock DS		DSLckOff	DSLckOn
20	LineEndOpen	Report line open at local end	Open	Closed
21	Status	Report operating status of local GSSE device	Offline	Available
22	Event		EventOff	EventOn
23	Fault Present		FaultOff	FaultOn
24	Sustained Arc	Report sustained arc	SustArcOff	SustArcOn
25	Downed Conductor	Report downed conductor	DownedOff	DownedOn
26	Sync Closing		SyncClsOff	SyncClsOn
27	Mode	Report mode status of local GSSE device	Normal	Test
28→32	Reserved			



For more information on GSSE specifications, see the *Remote Inputs/Outputs Overview* in the *Remote Devices* section.

NOTE

b) USERST BIT PAIRS

PATH: SETTINGS ⇒ INPUTS/OUTPUTS ⇒ REMOTE OUTPUTS UserSt BIT PAIRS ⇒ REMOTE OUTPUTS UserSt- 1(32) BIT PAIR

<input type="checkbox"/> REMOTE OUTPUTS <input checked="" type="checkbox"/> UserSt- 1 BIT PAIR		UserSt- 1 OPERAND: Off	Range: FlexLogic™ operand
		UserSt- 1 EVENTS: Disabled	Range: Disabled, Enabled

MESSAGE

Remote Outputs 1 to 32 originate as GSSE messages to be transmitted to remote devices. Each digital point in the message must be programmed to carry the state of a specific FlexLogic™ operand. The setting above is used to select the operand which represents a specific UserSt function (as selected by the user) to be transmitted.

The following setting represents the time between sending GSSE messages when there has been no change of state of any selected digital point. This setting is located in the **PRODUCT SETUP** ⇒ **COMMUNICATIONS** ⇒ **IEC 61850 PROTOCOL** settings menu.

DEFAULT GSSE UPDATE TIME: 60 s	Range: 1 to 60 s in steps of 1
-----------------------------------	--------------------------------



For more information on GSSE specifications, see the *Remote Inputs/Outputs Overview* in the *Remote Devices* section.

5.7.9 RESETTING

PATH: SETTINGS ⇒ INPUTS/OUTPUTS ⇒ RESETTING

<input checked="" type="checkbox"/> RESETTING		RESET OPERAND: Off	Range: FlexLogic™ operand
---	--	-----------------------	---------------------------

Some events can be programmed to latch the faceplate LED event indicators and the target message on the display. Once set, the latching mechanism will hold all of the latched indicators or messages in the set state after the initiating condition has cleared until a RESET command is received to return these latches (not including FlexLogic™ latches) to the reset state. The RESET command can be sent from the faceplate Reset button, a remote device via a communications channel, or any programmed operand.

When the RESET command is received by the relay, two FlexLogic™ operands are created. These operands, which are stored as events, reset the latches if the initiating condition has cleared. The three sources of RESET commands each create the RESET OP FlexLogic™ operand. Each individual source of a RESET command also creates its individual operand RESET OP (PUSHBUTTON), RESET OP (COMMS) or RESET OP (OPERAND) to identify the source of the command. The setting shown above selects the operand that will create the RESET OP (OPERAND) operand.

5.7.10 DIRECT INPUTS/OUTPUTS

a) DIRECT INPUTS

PATH: SETTINGS ⇒ INPUTS/OUTPUTS ⇒ DIRECT INPUTS ⇒ DIRECT INPUT 1(32)

<input checked="" type="checkbox"/> DIRECT INPUT 1		DIRECT INPUT 1 DEVICE ID: 1	Range: 1 to 16
		DIRECT INPUT 1 BIT NUMBER: 1	Range: 1 to 32
MESSAGE		DIRECT INPUT 1 DEFAULT STATE: Off	Range: On, Off, Latest/On, Latest/Off
MESSAGE			
MESSAGE		DIRECT INPUT 1 EVENTS: Disabled	Range: Enabled, Disabled
MESSAGE			

These settings specify how the direct input information is processed. The **DIRECT INPUT DEVICE ID** represents the source of this direct input. The specified direct input is driven by the device identified here.

The **DIRECT INPUT 1 BIT NUMBER** is the bit number to extract the state for this direct input. Direct Input x is driven by the bit identified here as **DIRECT INPUT 1 BIT NUMBER**. This corresponds to the direct output number of the sending device.

The **DIRECT INPUT 1 DEFAULT STATE** represents the state of the direct input when the associated direct device is offline. The following choices are available:

- Setting **DIRECT INPUT 1 DEFAULT STATE** to “On” value defaults the input to Logic 1.
- Setting **DIRECT INPUT 1 DEFAULT STATE** to “Off” value defaults the input to Logic 0.
- Setting **DIRECT INPUT 1 DEFAULT STATE** to “Latest/On” freezes the input in case of lost communications. If the latest state is not known, such as after relay power-up but before the first communication exchange, the input will default to Logic 1. When communication resumes, the input becomes fully operational.
- Setting **DIRECT INPUT 1 DEFAULT STATE** to “Latest/Off” freezes the input in case of lost communications. If the latest state is not known, such as after relay power-up but before the first communication exchange, the input will default to Logic 0. When communication resumes, the input becomes fully operational.

b) DIRECT OUTPUTS

PATH: SETTINGS ⇒ INPUTS/OUTPUTS ⇒ DIRECT OUTPUTS ⇒ DIRECT OUTPUT 1(32)

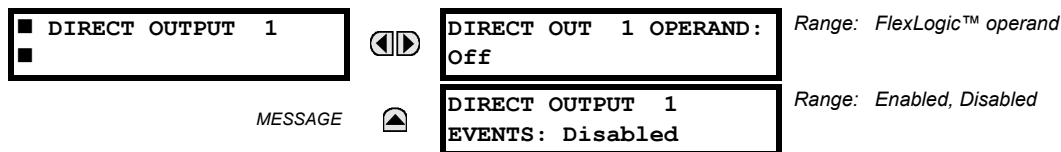

The **DIR OUT 1 OPERAND** is the FlexLogic™ operand that determines the state of this Direct Output.

c) APPLICATION EXAMPLES

The examples introduced in the earlier *Direct Inputs/Outputs* section (part of the *Product Setup* section) direct inputs/outputs are continued below to illustrate usage of the direct inputs and outputs.

EXAMPLE 1: EXTENDING INPUT/OUTPUT CAPABILITIES OF A F35 RELAY

Consider an application that requires additional quantities of digital inputs and/or output contacts and/or lines of programmable logic that exceed the capabilities of a single UR-series chassis. The problem is solved by adding an extra UR-series IED, such as the C30, to satisfy the additional inputs/outputs and programmable logic requirements. The two IEDs are connected via single-channel digital communication cards as shown below.

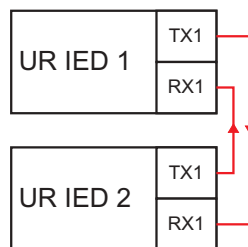

Figure 5–66: INPUT/OUTPUT EXTENSION VIA DIRECT INPUTS/OUTPUTS

Assume Contact Input 1 from UR IED 2 is to be used by UR IED 1. The following settings should be applied (Direct Input 5 and bit number 12 are used, as an example):

UR IED 1: **DIRECT INPUT 5 DEVICE ID = “2”**
DIRECT INPUT 5 BIT NUMBER = “12”

UR IED 2: **DIRECT OUT 12 OPERAND = “Cont Ip 1 On”**

The Cont Ip 1 On operand of UR IED 2 is now available in UR IED 1 as DIRECT INPUT 5 ON.

EXAMPLE 2: INTERLOCKING BUSBAR PROTECTION

A simple interlocking busbar protection scheme can be accomplished by sending a blocking signal from downstream devices, say 2, 3 and 4, to the upstream device that monitors a single incomer of the busbar, as shown in the figure below.

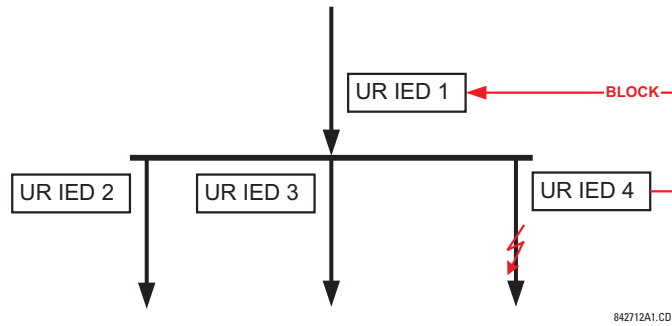

Figure 5-67: SAMPLE INTERLOCKING BUSBAR PROTECTION SCHEME

Assume that Phase Instantaneous Overcurrent 1 is used by Devices 2, 3, and 4 to block Device 1. If not blocked, Device 1 would trip the bus upon detecting a fault and applying a short coordination time delay.

The following settings should be applied (assume Bit 3 is used by all 3 devices to send the blocking signal and Direct Inputs 7, 8, and 9 are used by the receiving device to monitor the three blocking signals):

UR IED 2: **DIRECT OUT 3 OPERAND:** "PHASE IOC1 OP"

UR IED 3: **DIRECT OUT 3 OPERAND:** "PHASE IOC1 OP"

UR IED 4: **DIRECT OUT 3 OPERAND:** "PHASE IOC1 OP"

UR IED 1: **DIRECT INPUT 7 DEVICE ID:** "2"

DIRECT INPUT 7 BIT NUMBER: "3"

DIRECT INPUT 7 DEFAULT STATE: select "On" for security, select "Off" for dependability

DIRECT INPUT 8 DEVICE ID: "3"

DIRECT INPUT 8 BIT NUMBER: "3"

DIRECT INPUT 8 DEFAULT STATE: select "On" for security, select "Off" for dependability

DIRECT INPUT 9 DEVICE ID: "4"

DIRECT INPUT 9 BIT NUMBER: "3"

DIRECT INPUT 9 DEFAULT STATE: select "On" for security, select "Off" for dependability

Now the three blocking signals are available in UR IED 1 as DIRECT INPUT 7 ON, DIRECT INPUT 8 ON, and DIRECT INPUT 9 ON. Upon losing communications or a device, the scheme is inclined to block (if any default state is set to "On"), or to trip the bus on any overcurrent condition (all default states set to "Off").

EXAMPLE 2: PILOT-AIDED SCHEMES

Consider a three-terminal line protection application shown in the figure below.

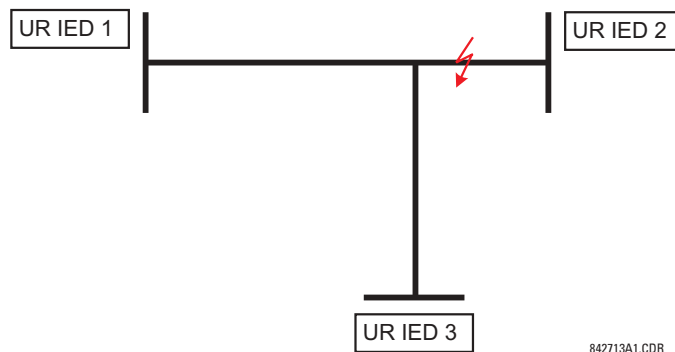

Figure 5-68: THREE-TERMINAL LINE APPLICATION

Assume the Hybrid Permissive Overreaching Transfer Trip (Hybrid POTT) scheme is applied using the architecture shown below. The scheme output operand HYB POTT TX1 is used to key the permission.

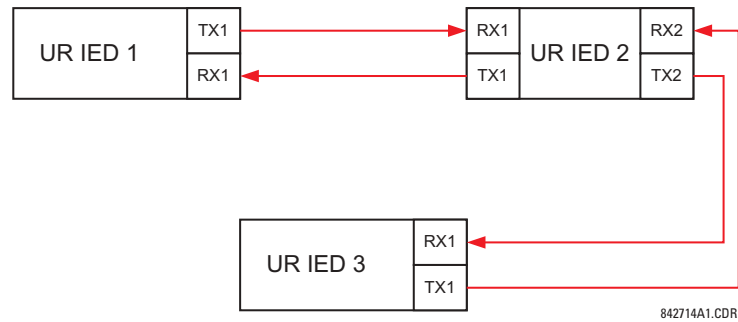

Figure 5-69: SINGLE-CHANNEL OPEN-LOOP CONFIGURATION

In the above architecture, Devices 1 and 3 do not communicate directly. Therefore, Device 2 must act as a 'bridge'. The following settings should be applied:

- UR IED 1: **DIRECT OUT 2 OPERAND:** "HYB POTT TX1"
DIRECT INPUT 5 DEVICE ID: "2"
DIRECT INPUT 5 BIT NUMBER: "2" (this is a message from IED 2)
DIRECT INPUT 6 DEVICE ID: "2"
DIRECT INPUT 6 BIT NUMBER: "4" (effectively, this is a message from IED 3)
- UR IED 3: **DIRECT OUT 2 OPERAND:** "HYB POTT TX1"
DIRECT INPUT 5 DEVICE ID: "2"
DIRECT INPUT 5 BIT NUMBER: "2" (this is a message from IED 2)
DIRECT INPUT 6 DEVICE ID: "2"
DIRECT INPUT 6 BIT NUMBER: "3" (effectively, this is a message from IED 1)
- UR IED 2: **DIRECT INPUT 5 DEVICE ID:** "1"
DIRECT INPUT 5 BIT NUMBER: "2"
DIRECT INPUT 6 DEVICE ID: "3"
DIRECT INPUT 6 BIT NUMBER: "2"
DIRECT OUT 2 OPERAND: "HYB POTT TX1"
DIRECT OUT 3 OPERAND: "DIRECT INPUT 5" (forward a message from 1 to 3)
DIRECT OUT 4 OPERAND: "DIRECT INPUT 6" (forward a message from 3 to 1)

Signal flow between the three IEDs is shown in the figure below:

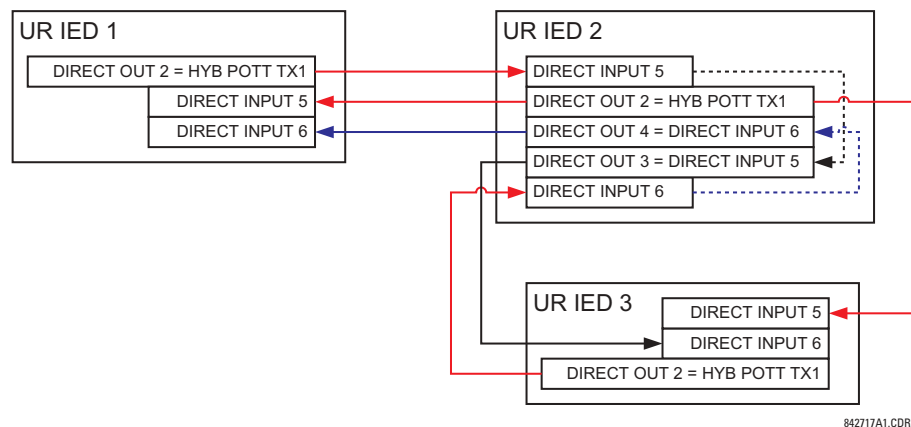

Figure 5-70: SIGNAL FLOW FOR DIRECT INPUT/OUTPUT EXAMPLE 3

In three-terminal applications, both the remote terminals must grant permission to trip. Therefore, at each terminal, Direct Inputs 5 and 6 should be ANDed in FlexLogic™ and the resulting operand configured as the permission to trip (HYB POTT RX1 setting).

5.8.1 DCMA INPUTS

PATH: SETTINGS ⇨⇩ TRANSDUCER I/O ⇨⇩ DCMA INPUTS ⇨⇩ DCMA INPUT H1(W8)

■ DCMA INPUT H1	◀▶	DCMA INPUT H1 FUNCTION: Disabled	Range: Disabled, Enabled
MESSAGE	▲▼	DCMA INPUT H1 ID: DCMA Ip 1	Range: up to 20 alphanumeric characters
MESSAGE	▲▼	DCMA INPUT H1 UNITS: μ A	Range: 6 alphanumeric characters
MESSAGE	▲▼	DCMA INPUT H1 RANGE: 0 to -1 mA	Range: 0 to -1 mA, 0 to +1 mA, -1 to +1 mA, 0 to 5 mA, 0 to 10mA, 0 to 20 mA, 4 to 20 mA
MESSAGE	▲▼	DCMA INPUT H1 MIN VALUE: 0.000	Range: -9999.999 to +9999.999 in steps of 0.001
MESSAGE	▲	DCMA INPUT H1 MAX VALUE: 0.000	Range: -9999.999 to +9999.999 in steps of 0.001

Hardware and software is provided to receive signals from external transducers and convert these signals into a digital format for use as required. The relay will accept inputs in the range of -1 to +20 mA DC, suitable for use with most common transducer output ranges; all inputs are assumed to be linear over the complete range. Specific hardware details are contained in Chapter 3.

Before the dcmA input signal can be used, the value of the signal measured by the relay must be converted to the range and quantity of the external transducer primary input parameter, such as DC voltage or temperature. The relay simplifies this process by internally scaling the output from the external transducer and displaying the actual primary parameter.

dcmA input channels are arranged in a manner similar to CT and VT channels. The user configures individual channels with the settings shown here.

The channels are arranged in sub-modules of two channels, numbered from 1 through 8 from top to bottom. On power-up, the relay will automatically generate configuration settings for every channel, based on the order code, in the same general manner that is used for CTs and VTs. Each channel is assigned a slot letter followed by the row number, 1 through 8 inclusive, which is used as the channel number. The relay generates an actual value for each available input channel.

Settings are automatically generated for every channel available in the specific relay as shown above for the first channel of a type 5F transducer module installed in slot H.

The function of the channel may be either “Enabled” or “Disabled”. If “Disabled”, no actual values are created for the channel. An alphanumeric “ID” is assigned to each channel; this ID will be included in the channel actual value, along with the programmed units associated with the parameter measured by the transducer, such as volts, °C, megawatts, etc. This ID is also used to reference the channel as the input parameter to features designed to measure this type of parameter. The **DCMA INPUT H1 RANGE** setting specifies the mA DC range of the transducer connected to the input channel.

The **DCMA INPUT H1 MIN VALUE** and **DCMA INPUT H1 MAX VALUE** settings are used to program the span of the transducer in primary units. For example, a temperature transducer might have a span from 0 to 250°C; in this case the **DCMA INPUT H1 MIN VALUE** value is “0” and the **DCMA INPUT H1 MAX VALUE** value is “250”. Another example would be a watts transducer with a span from -20 to +180 MW; in this case the **DCMA INPUT H1 MIN VALUE** value would be “-20” and the **DCMA INPUT H1 MAX VALUE** value “180”. Intermediate values between the min and max values are scaled linearly.

5.8.2 RTD INPUTS

PATH: SETTINGS ⇒ TRANSDUCER I/O ⇒ RTD INPUTS ⇒ RTD INPUT H1(W8)

■ RTD INPUT H1	◀▶	RTD INPUT H1 FUNCTION: Disabled	Range: Disabled, Enabled
MESSAGE	▲▼	RTD INPUT H1 ID: RTD Ip 1	Range: Up to 20 alphanumeric characters
MESSAGE	▲	RTD INPUT H1 TYPE: 100Ω Nickel	Range: 100Ω Nickel, 10Ω Copper, 100Ω Platinum, 120Ω Nickel

Hardware and software is provided to receive signals from external Resistance Temperature Detectors and convert these signals into a digital format for use as required. These channels are intended to be connected to any of the RTD types in common use. Specific hardware details are contained in Chapter 3.

RTD input channels are arranged in a manner similar to CT and VT channels. The user configures individual channels with the settings shown here.

The channels are arranged in sub-modules of two channels, numbered from 1 through 8 from top to bottom. On power-up, the relay will automatically generate configuration settings for every channel, based on the order code, in the same general manner that is used for CTs and VTs. Each channel is assigned a slot letter followed by the row number, 1 through 8 inclusive, which is used as the channel number. The relay generates an actual value for each available input channel.

Settings are automatically generated for every channel available in the specific relay as shown above for the first channel of a type 5C transducer module installed in slot H.

The function of the channel may be either “Enabled” or “Disabled”. If “Disabled”, there will not be an actual value created for the channel. An alphanumeric ID is assigned to the channel; this ID will be included in the channel actual values. It is also used to reference the channel as the input parameter to features designed to measure this type of parameter. Selecting the type of RTD connected to the channel configures the channel.

Actions based on RTD overtemperature, such as trips or alarms, are done in conjunction with the FlexElements™ feature. In FlexElements™, the operate level is scaled to a base of 100°C. For example, a trip level of 150°C is achieved by setting the operate level at 1.5 pu. FlexElement™ operands are available to FlexLogic™ for further interlocking or to operate an output contact directly.

5

5.8.3 DCMA OUTPUTS

PATH: SETTINGS ⇒ TRANSDUCER I/O ⇒ DCMA OUTPUTS ⇒ DCMA OUTPUT H1(W8)

■ DCMA OUTPUT H1	◀▶	DCMA OUTPUT H1 SOURCE: Off	Range: Off, any analog actual value parameter
MESSAGE	▲▼	DCMA OUTPUT H1 RANGE: -1 to 1 mA	Range: -1 to 1 mA, 0 to 1 mA, 4 to 20 mA
MESSAGE	▲	DCMA OUTPUT H1 MIN VAL: 0.000 pu	Range: -90.000 to 90.000 pu in steps of 0.001
MESSAGE	▲	DCMA OUTPUT H1 MAX VAL: 1.000 pu	Range: -90.000 to 90.000 pu in steps of 0.001

Hardware and software is provided to generate dcmA signals that allow interfacing with external equipment. Specific hardware details are contained in Chapter 3. The dcmA output channels are arranged in a manner similar to transducer input or CT and VT channels. The user configures individual channels with the settings shown below.

The channels are arranged in sub-modules of two channels, numbered 1 through 8 from top to bottom. On power-up, the relay automatically generates configuration settings for every channel, based on the order code, in the same manner used for CTs and VTs. Each channel is assigned a slot letter followed by the row number, 1 through 8 inclusive, which is used as the channel number.

Both the output range and a signal driving a given output are user-programmable via the following settings menu (an example for channel M5 is shown).

The relay checks the driving signal (x in equations below) for the minimum and maximum limits, and subsequently re-scales so the limits defined as **MIN VAL** and **MAX VAL** match the output range of the hardware defined as **RANGE**. The following equation is applied:

$$I_{out} = \begin{cases} I_{min} & \text{if } x < \text{MIN VAL} \\ I_{max} & \text{if } x > \text{MAX VAL} \\ k(x - \text{MIN VAL}) + I_{min} & \text{otherwise} \end{cases} \quad (\text{EQ 5.15})$$

where: x is a driving signal specified by the **SOURCE** setting

I_{min} and I_{max} are defined by the **RANGE** setting

k is a scaling constant calculated as:

$$k = \frac{I_{max} - I_{min}}{\text{MAX VAL} - \text{MIN VAL}} \quad (\text{EQ 5.16})$$

The feature is intentionally inhibited if the **MAX VAL** and **MIN VAL** settings are entered incorrectly, e.g. when **MAX VAL** – **MIN VAL** < 0.1 pu. The resulting characteristic is illustrated in the following figure.

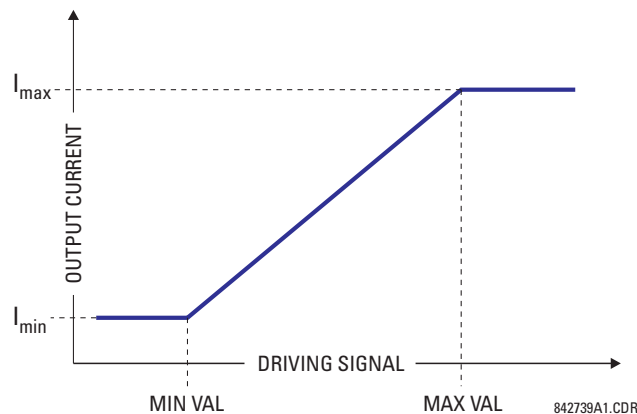

Figure 5-71: DCMA OUTPUT CHARACTERISTIC

The dcmA output settings are described below.

- **DCMA OUTPUT H1 SOURCE:** This setting specifies an internal analog value to drive the analog output. Actual values (FlexAnalog parameters) such as power, current amplitude, voltage amplitude, power factor, etc. can be configured as sources driving dcmA outputs. Refer to Appendix A for a complete list of FlexAnalog parameters.
- **DCMA OUTPUT H1 RANGE:** This setting allows selection of the output range. Each dcmA channel may be set independently to work with different ranges. The three most commonly used output ranges are available.
- **DCMA OUTPUT H1 MIN VAL:** This setting allows setting the minimum limit for the signal that drives the output. This setting is used to control the mapping between an internal analog value and the output current (see the following examples). The setting is entered in per-unit values. The base units are defined in the same manner as the FlexElement™ base units.
- **DCMA OUTPUT H1 MAX VAL:** This setting allows setting the maximum limit for the signal that drives the output. This setting is used to control the mapping between an internal analog value and the output current (see the following examples). The setting is entered in per-unit values. The base units are defined in the same manner as the FlexElement™ base units.

Three application examples are described below.

EXAMPLE 1:

A three phase active power on a 13.8 kV system measured via UR-series relay source 1 is to be monitored by the dcmA H1 output of the range of –1 to 1 mA. The following settings are applied on the relay: CT ratio = 1200:5, VT secondary 115, VT connection is delta, and VT ratio = 120. The nominal current is 800 A primary and the nominal power factor is 0.90. The power is to be monitored in both importing and exporting directions and allow for 20% overload compared to the nominal.

The nominal three-phase power is:

$$P = \sqrt{3} \times 13.8 \text{ kV} \times 0.8 \text{ kA} \times 0.9 = 17.21 \text{ MW} \quad (\text{EQ 5.17})$$

The three-phase power with 20% overload margin is:

$$P_{max} = 1.2 \times 17.21 \text{ MW} = 20.65 \text{ MW} \quad (\text{EQ 5.18})$$

The base unit for power (refer to the FlexElements section in this chapter for additional details) is:

$$P_{BASE} = 115 \text{ V} \times 120 \times 1.2 \text{ kA} = 16.56 \text{ MW} \quad (\text{EQ 5.19})$$

The minimum and maximum power values to be monitored (in pu) are:

$$\text{minimum power} = \frac{-20.65 \text{ MW}}{16.56 \text{ MW}} = -1.247 \text{ pu}, \quad \text{maximum power} = \frac{20.65 \text{ MW}}{16.56 \text{ MW}} = 1.247 \text{ pu} \quad (\text{EQ 5.20})$$

The following settings should be entered:

DCMA OUTPUT H1 SOURCE: "SRC 1 P"
DCMA OUTPUT H1 RANGE: "-1 to 1 mA"
DCMA OUTPUT H1 MIN VAL: "-1.247 pu"
DCMA OUTPUT H1 MIN VALL "1.247 pu"

With the above settings, the output will represent the power with the scale of 1 mA per 20.65 MW. The worst-case error for this application can be calculated by superimposing the following two sources of error:

- $\pm 0.5\%$ of the full scale for the analog output module, or $\pm 0.005 \times (1 - (-1)) \times 20.65 \text{ MW} = \pm 0.207 \text{ MW}$
- $\pm 1\%$ of reading error for the active power at power factor of 0.9

For example at the reading of 20 MW, the worst-case error is $0.01 \times 20 \text{ MW} + 0.207 \text{ MW} = 0.407 \text{ MW}$.

EXAMPLE 2:

The phase A current (true RMS value) is to be monitored via the H2 current output working with the range from 4 to 20 mA. The CT ratio is 5000:5 and the maximum load current is 4200 A. The current should be monitored from 0 A upwards, allowing for 50% overload.

The phase current with the 50% overload margin is:

$$I_{max} = 1.5 \times 4.2 \text{ kA} = 6.3 \text{ kA} \quad (\text{EQ 5.21})$$

The base unit for current (refer to the FlexElements section in this chapter for additional details) is:

$$I_{BASE} = 5 \text{ kA} \quad (\text{EQ 5.22})$$

The minimum and maximum power values to be monitored (in pu) are:

$$\text{minimum current} = \frac{0 \text{ kA}}{5 \text{ kA}} = 0 \text{ pu}, \quad \text{maximum current} = \frac{6.3 \text{ kA}}{5 \text{ kA}} = 1.26 \text{ pu} \quad (\text{EQ 5.23})$$

The following settings should be entered:

DCMA OUTPUT H2 SOURCE: "SRC 1 Ia RMS"
DCMA OUTPUT H2 RANGE: "4 to 20 mA"
DCMA OUTPUT H2 MIN VAL: "0.000 pu"
DCMA OUTPUT H2 MIN VAL: "1.260 pu"

The worst-case error for this application could be calculated by superimposing the following two sources of error:

- $\pm 0.5\%$ of the full scale for the analog output module, or $\pm 0.005 \times (20 - 4) \times 6.3 \text{ kA} = \pm 0.504 \text{ kA}$
- $\pm 0.25\%$ of reading or $\pm 0.1\%$ of rated (whichever is greater) for currents between 0.1 and 2.0 of nominal

For example, at the reading of 4.2 kA, the worst-case error is $\max(0.0025 \times 4.2 \text{ kA}, 0.001 \times 5 \text{ kA}) + 0.504 \text{ kA} = 0.515 \text{ kA}$.

EXAMPLE 3:

A positive-sequence voltage on a 400 kV system measured via Source 2 is to be monitored by the dcma H3 output with a range of 0 to 1 mA. The VT secondary setting is 66.4 V, the VT ratio setting is 6024, and the VT connection setting is "Delta". The voltage should be monitored in the range from 70% to 110% of nominal.

The minimum and maximum positive-sequence voltages to be monitored are:

$$V_{min} = 0.7 \times \frac{400 \text{ kV}}{\sqrt{3}} = 161.66 \text{ kV}, \quad V_{max} = 1.1 \times \frac{400 \text{ kV}}{\sqrt{3}} = 254.03 \text{ kV} \quad (\text{EQ 5.24})$$

The base unit for voltage (refer to the FlexElements section in this chapter for additional details) is:

$$V_{BASE} = 0.0664 \text{ kV} \times 6024 = 400 \text{ kV} \quad (\text{EQ 5.25})$$

The minimum and maximum voltage values to be monitored (in pu) are:

$$\text{minimum voltage} = \frac{161.66 \text{ kV}}{400 \text{ kV}} = 0.404 \text{ pu}, \quad \text{maximum voltage} = \frac{254.03 \text{ kV}}{400 \text{ kV}} = 0.635 \text{ pu} \quad (\text{EQ 5.26})$$

The following settings should be entered:

DCMA OUTPUT H3 SOURCE: "SRC 2 V_1 mag"

DCMA OUTPUT H3 RANGE: "0 to 1 mA"

DCMA OUTPUT H3 MIN VAL: "0.404 pu"

DCMA OUTPUT H3 MIN VAL: "0.635 pu"

The limit settings differ from the expected 0.7 pu and 1.1 pu because the relay calculates the positive-sequence quantities scaled to the phase-to-ground voltages, even if the VTs are connected in "Delta" (refer to the *Metering Conventions* section in Chapter 6), while at the same time the VT nominal voltage is 1 pu for the settings. Consequently the settings required in this example differ from naturally expected by the factor of $\sqrt{3}$.

The worst-case error for this application could be calculated by superimposing the following two sources of error:

- $\pm 0.5\%$ of the full scale for the analog output module, or $\pm 0.005 \times (1 - 0) \times 254.03 \text{ kV} = \pm 1.27 \text{ kV}$
- $\pm 0.5\%$ of reading

For example, under nominal conditions, the positive-sequence reads 230.94 kV and the worst-case error is $0.005 \times 230.94 \text{ kV} + 1.27 \text{ kV} = 2.42 \text{ kV}$.

5.9.1 TEST MODE

PATH: SETTINGS ⇌ TESTING ⇌ TEST MODE

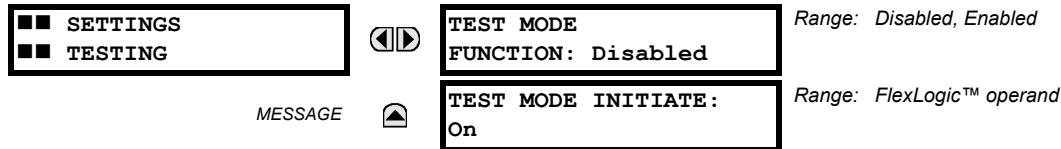

The relay provides test settings to verify that functionality using simulated conditions for contact inputs and outputs. The Test Mode is indicated on the relay faceplate by a flashing Test Mode LED indicator.

To initiate the Test mode, the **TEST MODE FUNCTION** setting must be “Enabled” and the **TEST MODE INITIATE** setting must be set to Logic 1. In particular:

- To initiate Test Mode through relay settings, set **TEST MODE INITIATE** to “On”. The Test Mode starts when the **TEST MODE FUNCTION** setting is changed from “Disabled” to “Enabled”.
- To initiate Test Mode through a user-programmable condition, such as FlexLogic™ operand (pushbutton, digital input, communication-based input, or a combination of these), set **TEST MODE FUNCTION** to “Enabled” and set **TEST MODE INITIATE** to the desired operand. The Test Mode starts when the selected operand assumes a Logic 1 state.

When in Test Mode, the F35 remains fully operational, allowing for various testing procedures. In particular, the protection and control elements, FlexLogic™, and communication-based inputs and outputs function normally.

The only difference between the normal operation and the Test Mode is the behavior of the input and output contacts. The former can be forced to report as open or closed or remain fully operational; the latter can be forced to open, close, freeze, or remain fully operational. The response of the digital input and output contacts to the Test Mode is programmed individually for each input and output using the Force Contact Inputs and Force Contact Outputs test functions described in the following sections.

5.9.2 FORCE CONTACT INPUTS

PATH: SETTINGS ⇌ TESTING ⇌ FORCE CONTACT INPUTS

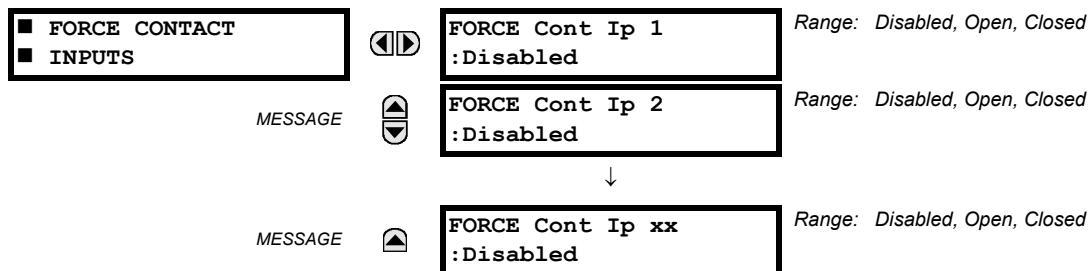

The relay digital inputs (contact inputs) could be pre-programmed to respond to the Test Mode in the following ways:

- If set to “Disabled”, the input remains fully operational. It is controlled by the voltage across its input terminals and can be turned on and off by external circuitry. This value should be selected if a given input must be operational during the test. This includes, for example, an input initiating the test, or being a part of a user pre-programmed test sequence.
- If set to “Open”, the input is forced to report as opened (Logic 0) for the entire duration of the Test Mode regardless of the voltage across the input terminals.
- If set to “Closed”, the input is forced to report as closed (Logic 1) for the entire duration of the Test Mode regardless of the voltage across the input terminals.

The Force Contact Inputs feature provides a method of performing checks on the function of all contact inputs. Once enabled, the relay is placed into Test Mode, allowing this feature to override the normal function of contact inputs. The Test Mode LED will be On, indicating that the relay is in Test Mode. The state of each contact input may be programmed as “Disabled”, “Open”, or “Closed”. All contact input operations return to normal when all settings for this feature are disabled.

5.9.3 FORCE CONTACT OUTPUTS

PATH: SETTINGS ⇒ TESTING ⇒ FORCE CONTACT OUTPUTS

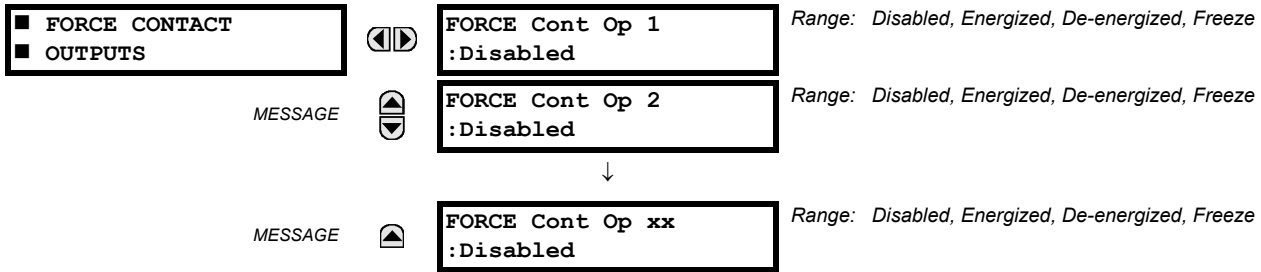

The relay contact outputs can be pre-programmed to respond to the Test Mode.

If set to “Disabled”, the contact output remains fully operational. It operates when its control operand is Logic 1 and will reset when its control operand is Logic 0. If set to “Energize”, the output will close and remain closed for the entire duration of the Test Mode, regardless of the status of the operand configured to control the output contact. If set to “De-energize”, the output will open and remain opened for the entire duration of the Test Mode regardless of the status of the operand configured to control the output contact. If set to “Freeze”, the output retains its position from before entering the Test Mode, regardless of the status of the operand configured to control the output contact.

These settings are applied two ways. First, external circuits may be tested by energizing or de-energizing contacts. Second, by controlling the output contact state, relay logic may be tested and undesirable effects on external circuits avoided.

Example 1: Initiating a Test from User-Programmable Pushbutton 1

The Test Mode should be initiated from User-Programmable Pushbutton 1. The pushbutton will be programmed as “Latched” (pushbutton pressed to initiate the test, and pressed again to terminate the test). During the test, Digital Input 1 should remain operational, Digital Inputs 2 and 3 should open, and Digital Input 4 should close. Also, Contact Output 1 should freeze, Contact Output 2 should open, Contact Output 3 should close, and Contact Output 4 should remain fully operational. The required settings are shown below.

To enable User-Programmable Pushbutton 1 to initiate the Test mode, make the following changes in the **SETTINGS ⇒ TESTING ⇒ TEST MODE** menu:

TEST MODE FUNCTION: “Enabled” and **TEST MODE INITIATE:** “PUSHBUTTON 1 ON”

Make the following changes to configure the Contact I/Os. In the **SETTINGS ⇒ TESTING ⇒ FORCE CONTACT INPUTS** and **FORCE CONTACT OUTPUTS** menus, set:

FORCE Cont Ip 1: “Disabled”, **FORCE Cont Ip 2:** “Open”, **FORCE Cont Ip 3:** “Open”, and **FORCE Cont Ip 4:** “Closed”

FORCE Cont Op 1: “Freeze”, **FORCE Cont Op 2:** “De-energized”, **FORCE Cont Op 3:** “Open”, and **FORCE Cont Op 4:** “Disabled”

Example 2: Initiating a Test from User-Programmable Pushbutton 1 or through Remote Input 1

The Test should be initiated locally from User-Programmable Pushbutton 1 or remotely through Remote Input 1. Both the pushbutton and the remote input will be programmed as “Latched”. The required settings are shown below.

Write the following FlexLogic™ equation (enerVista UR Setup example shown):

FLEX LOGIC ENTRY	TYPE	SYNTAX
View Graphic	View	View
FlexLogic Entry 1	Remote Inputs On	Remote IP 1 ON
FlexLogic Entry 2	Protectas Element	PUSHBUTTON 1 ON
FlexLogic Entry 3	OR	2 Input
FlexLogic Entry 4	Wire Virtual Output(Assign)	= Vrt Op 1 (VO1)
FlexLogic Entry 5	End of List	

Set the User Programmable Pushbutton as latching by changing **SETTINGS ⇒ PRODUCT SETUP ⇒ USER-PROGRAMMABLE PUSHBUTTONS ⇒ USER PUSHBUTTON 1 ⇒ PUSHBUTTON 1 FUNCTION** to “Latched”. To enable either Pushbutton 1 or Remote Input 1 to initiate the Test mode, make the following changes in the **SETTINGS ⇒ TESTING ⇒ TEST MODE** menu:

TEST MODE FUNCTION: “Enabled” and **TEST MODE INITIATE:** “VO1”

6.1.1 ACTUAL VALUES MAIN MENU

■ ■ ACTUAL VALUES
■ ■ STATUS



■ ■ ACTUAL VALUES
■ ■ METERING



■ CONTACT INPUTS
■

See page 6-3.

■ VIRTUAL INPUTS
■

See page 6-3.

■ REMOTE INPUTS
■

See page 6-3.

■ CONTACT OUTPUTS
■

See page 6-4.

■ VIRTUAL OUTPUTS
■

See page 6-4.

■ AUTORECLOSE
■

See page 6-4.

■ REMOTE DEVICES
■ STATUS

See page 6-4.

■ REMOTE DEVICES
■ STATISTICS

See page 6-5.

■ DIGITAL COUNTERS
■

See page 6-5.

■ SELECTOR SWITCHES
■

See page 6-5.

■ FLEX STATES
■

See page 6-5.

■ ETHERNET
■

See page 6-6.

■ DIRECT INPUTS
■

See page 6-6.

■ DIRECT DEVICES
■ STATUS

See page 6-7.

■ EGD PROTOCOL
■ STATUS

See page 6-7.

■ SOURCE SRC 1
■

See page 6-11.

■ SOURCE SRC 2
■

■ SOURCE SRC 3
■

■ SOURCE SRC 4
■

■ SOURCE SRC 5
■

■ SOURCE SRC 6
■

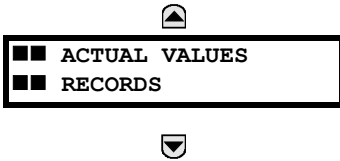

▲ ▼	■ TRACKING FREQUENCY ■	See page 6-15.
▲ ▼	■ FLEXELEMENTS ■	See page 6-15.
▲ ▼	■ TRANSDUCER I/O ■ DCMA INPUTS	See page 6-16.
▲	■ TRANSDUCER I/O ■ RTD INPUTS	See page 6-16.
◀▶	■ FAULT REPORTS ■	See page 6-17.
▲ ▼	■ EVENT RECORDS ■	See page 6-19.
▲ ▼	■ OSCILLOGRAPHY ■	See page 6-19.
▲ ▼	■ DATA LOGGER ■	See page 6-19.
▲	■ MAINTENANCE ■	See page 6-20.
◀▶	■ MODEL INFORMATION ■	See page 6-21.
▲	■ FIRMWARE REVISIONS ■	See page 6-21.



For status reporting, 'On' represents Logic 1 and 'Off' represents Logic 0.

6.2.1 CONTACT INPUTS

PATH: ACTUAL VALUES ⇒ STATUS ⇒ CONTACT INPUTS

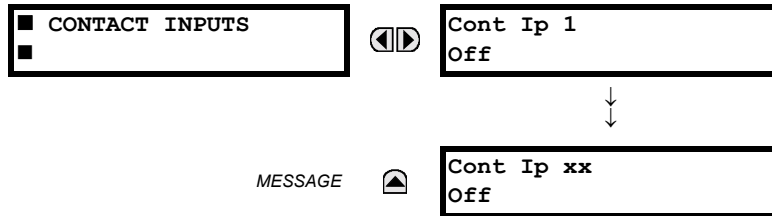

The present status of the contact inputs is shown here. The first line of a message display indicates the ID of the contact input. For example, 'Cont Ip 1' refers to the contact input in terms of the default name-array index. The second line of the display indicates the logic state of the contact input.

6.2.2 VIRTUAL INPUTS

PATH: ACTUAL VALUES ⇒ STATUS ⇒ ↓ VIRTUAL INPUTS

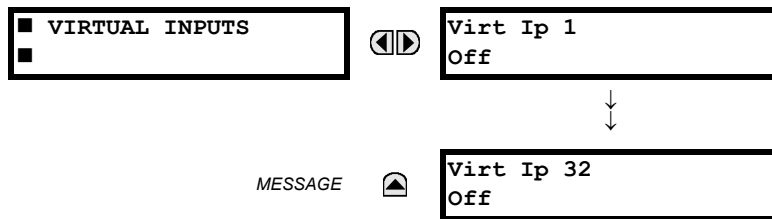

The present status of the 32 virtual inputs is shown here. The first line of a message display indicates the ID of the virtual input. For example, 'Virt Ip 1' refers to the virtual input in terms of the default name. The second line of the display indicates the logic state of the virtual input.

6.2.3 REMOTE INPUTS

PATH: ACTUAL VALUES ⇒ STATUS ⇒ ↓ REMOTE INPUTS

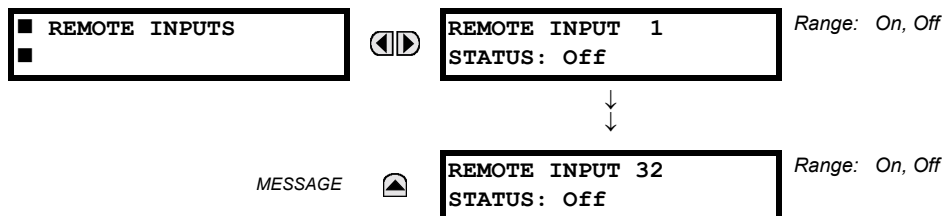

The present state of the 32 remote inputs is shown here.

The state displayed will be that of the remote point unless the remote device has been established to be "Offline" in which case the value shown is the programmed default state for the remote input.

6.2.4 CONTACT OUTPUTS

PATH: ACTUAL VALUES ⇒ STATUS ⇒ CONTACT OUTPUTS

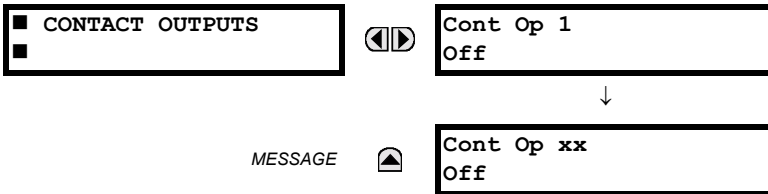

The present state of the contact outputs is shown here. The first line of a message display indicates the ID of the contact output. For example, 'Cont Op 1' refers to the contact output in terms of the default name-array index. The second line of the display indicates the logic state of the contact output.



For Form-A outputs, the state of the voltage(V) and/or current(I) detectors will show as: Off, VOff, IOff, On, VOn, and/or IOn. For Form-C outputs, the state will show as Off or On.

6.2.5 VIRTUAL OUTPUTS

PATH: ACTUAL VALUES ⇒ STATUS ⇒ VIRTUAL OUTPUTS

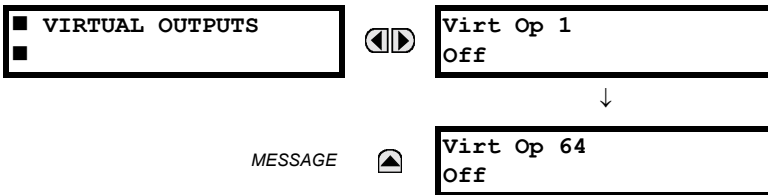

The present state of up to 64 virtual outputs is shown here. The first line of a message display indicates the ID of the virtual output. For example, 'Virt Op 1' refers to the virtual output in terms of the default name-array index. The second line of the display indicates the logic state of the virtual output, as calculated by the FlexLogic™ equation for that output.

6.2.6 AUTORECLOSE

PATH: ACTUAL VALUES ⇒ STATUS ⇒ AUTORECLOSE ⇒ AUTORECLOSE 1

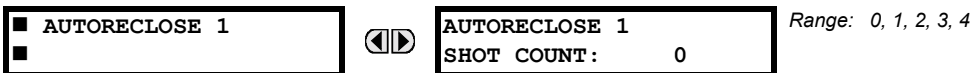

The automatic reclosure shot count is shown here.

6.2.7 REMOTE DEVICES

a) STATUS

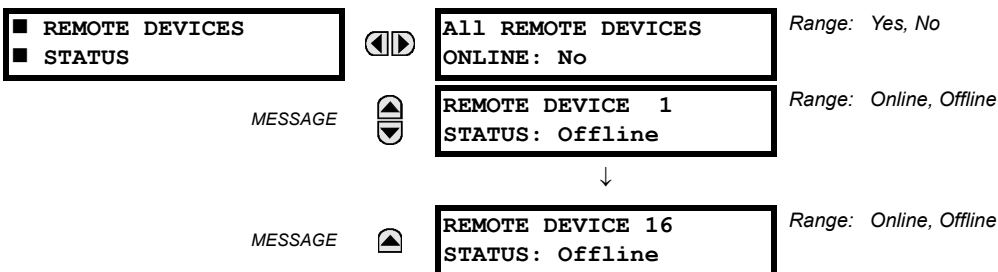

PATH: ACTUAL VALUES ⇒ STATUS ⇒ REMOTE DEVICES STATUS



The present state of up to 16 programmed Remote Devices is shown here. The **ALL REMOTE DEVICES ONLINE** message indicates whether or not all programmed Remote Devices are online. If the corresponding state is "No", then at least one required Remote Device is not online.

b) STATISTICS

PATH: ACTUAL VALUES ⇒ STATUS ⇒ REMOTE DEVICES STATISTICS ⇒ REMOTE DEVICE 1(16)





<ul style="list-style-type: none"> ■ REMOTE DEVICE 1 ■ 		REMOTE DEVICE 1 StNum: 0
MESSAGE		REMOTE DEVICE 1 SqNum: 0

Statistical data (2 types) for up to 16 programmed Remote Devices is shown here.

The **StNum** number is obtained from the indicated Remote Device and is incremented whenever a change of state of at least one DNA or UserSt bit occurs. The **SqNum** number is obtained from the indicated Remote Device and is incremented whenever a GSSE message is sent. This number will rollover to zero when a count of 4,294,967,295 is incremented.

6.2.8 DIGITAL COUNTERS



PATH: ACTUAL VALUES ⇒ DIGITAL COUNTERS ⇒ DIGITAL COUNTERS ⇒ DIGITAL COUNTERS Counter 1(8)

<ul style="list-style-type: none"> ■ DIGITAL COUNTERS ■ Counter 1 		Counter 1 ACCUM: 0
MESSAGE		Counter 1 FROZEN: 0
MESSAGE		Counter 1 FROZEN: YYYY/MM/DD HH:MM:SS
MESSAGE		Counter 1 MICROS: 0

The present status of the 8 digital counters is shown here. The status of each counter, with the user-defined counter name, includes the accumulated and frozen counts (the count units label will also appear). Also included, is the date/time stamp for the frozen count. The Counter n MICROS value refers to the microsecond portion of the time stamp.

6.2.9 SELECTOR SWITCHES



PATH: ACTUAL VALUES ⇒ STATUS ⇒ SELECTOR SWITCHES

<ul style="list-style-type: none"> ■ SELECTOR SWITCHES ■ 		SELECTOR SWITCH 1 POSITION: 0/7	Range: Current Position / 7
MESSAGE		SELECTOR SWITCH 2 POSITION: 0/7	Range: Current Position / 7

The display shows both the current position and the full range. The current position only (an integer from 0 through 7) is the actual value.

6.2.10 FLEX STATES

PATH: ACTUAL VALUES ⇒ STATUS ⇒ FLEX STATES

<ul style="list-style-type: none"> ■ FLEX STATES ■ 		PARAM 1: Off Off	Range: Off, On
MESSAGE		PARAM 256: Off Off	Range: Off, On

There are 256 FlexState bits available. The second line value indicates the state of the given FlexState bit.

6.2.11 ETHERNET

PATH: ACTUAL VALUES ⇒ STATUS ⇒ ↓ ETHERNET

■ ETHERNET ■	MESSAGE	◀▶	ETHERNET PRI LINK STATUS: OK	Range: Fail, OK
		▲	ETHERNET SEC LINK STATUS: OK	Range: Fail, OK

6.2.12 DIRECT INPUTS

PATH: ACTUAL VALUES ⇒ STATUS ⇒ ↓ DIRECT INPUTS

■ DIRECT INPUTS ■	MESSAGE	◀▶	AVG MSG RETURN TIME CH1: 0 ms
		▲▼	UNRETURNED MSG COUNT CH1: 0
		▲▼	CRC FAIL COUNT CH1: 0
		▲▼	AVG MSG RETURN TIME CH2: 0 ms
		▲▼	UNRETURNED MSG COUNT CH2: 0
		▲▼	CRC FAIL COUNT CH2: 0
		▲▼	DIRECT INPUT 1: On
		↓	
MESSAGE	▲	DIRECT INPUT 32: On	

The **AVERAGE MSG RETURN TIME** is the time taken for direct output messages to return to the sender in a direct input/output ring configuration (this value is not applicable for non-ring configurations). This is a rolling average calculated for the last 10 messages. There are two return times for dual-channel communications modules.

The **UNRETURNED MSG COUNT** values (one per communications channel) count the direct output messages that do not make the trip around the communications ring. The **CRC FAIL COUNT** values (one per communications channel) count the direct output messages that have been received but fail the CRC check. High values for either of these counts may indicate on a problem with wiring, the communication channel, or the relay(s). The **UNRETURNED MSG COUNT** and **CRC FAIL COUNT** values can be cleared using the **CLEAR DIRECT I/O COUNTERS** command.

The **DIRECT INPUT x** values represent the state of the x-th direct input.

6.2.13 DIRECT DEVICES STATUS

PATH: ACTUAL VALUES ⇒ STATUS ⇒ DIRECT DEVICES STATUS

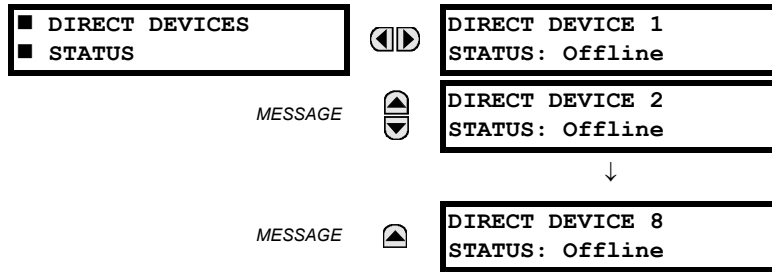

These actual values represent the state of Direct Devices 1 through 8.

6.2.14 EGD PROTOCOL STATUS

a) FAST EXCHANGE

PATH: ACTUAL VALUES ⇒ STATUS ⇒ EGD PROTOCOL STATUS ⇒ PRODUCER STATUS ⇒ FAST EXCHANGE 1

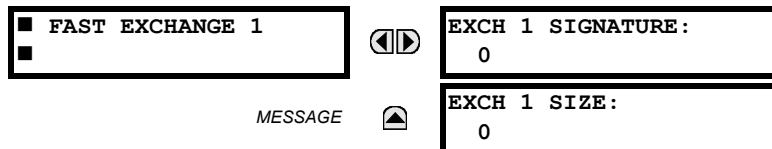

These values provide information that may be useful for debugging an EGD network. The EGD signature and packet size for the fast EGD exchange is displayed.

b) SLOW EXCHANGE

PATH: ACTUAL VALUES ⇒ STATUS ⇒ EGD PROTOCOL STATUS ⇒ PRODUCER STATUS ⇒ SLOW EXCHANGE 1(2)

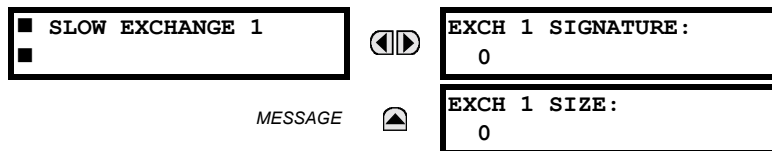

These values provide information that may be useful for debugging an EGD network. The EGD signature and packet size for the slow EGD exchanges are displayed.

6.3.1 METERING CONVENTIONS

a) UR CONVENTION FOR MEASURING POWER AND ENERGY

The following figure illustrates the conventions established for use in UR-series relays.

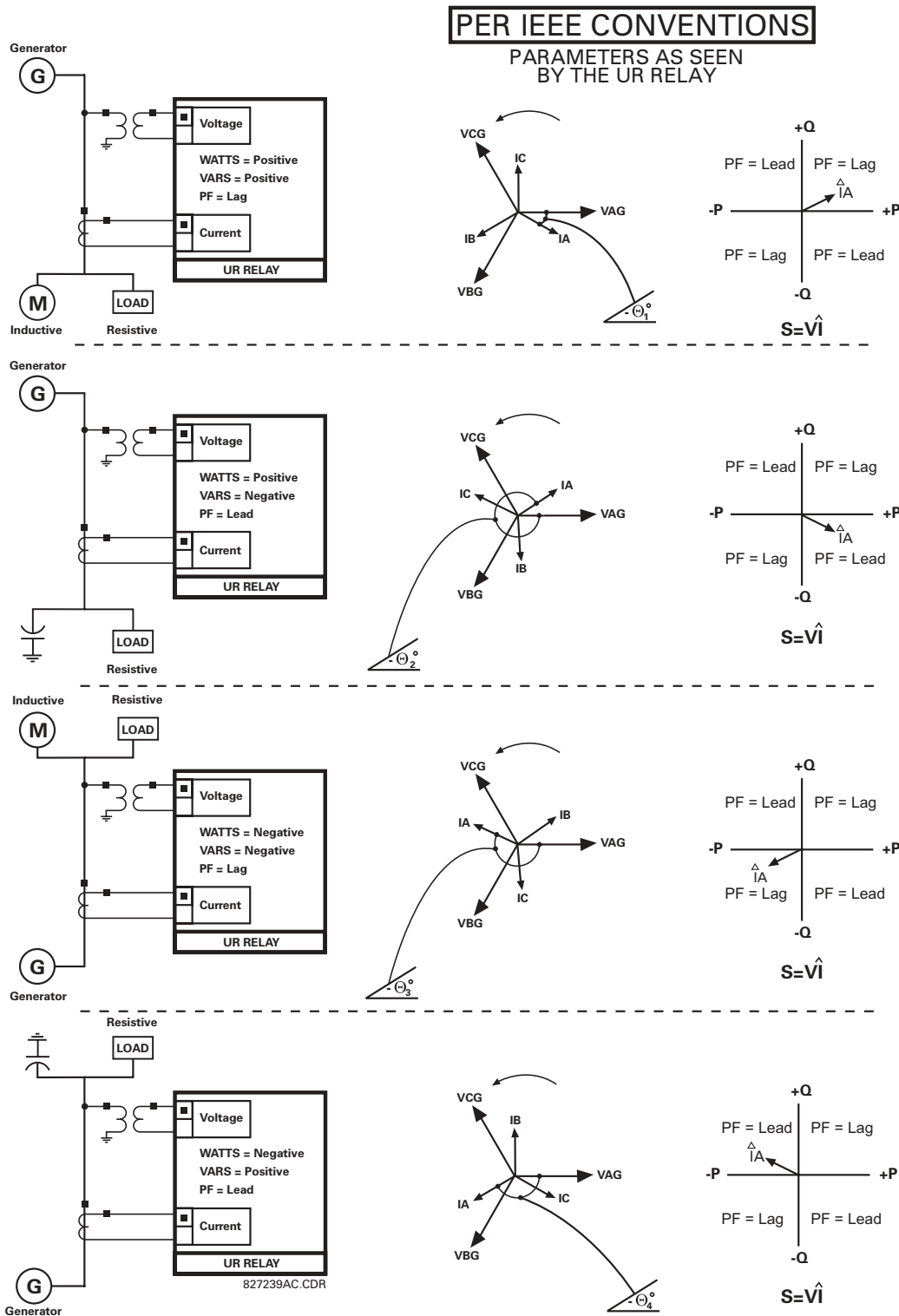

Figure 6-1: FLOW DIRECTION OF SIGNED VALUES FOR WATTS AND VARS

b) UR CONVENTION FOR MEASURING PHASE ANGLES

All phasors calculated by UR-series relays and used for protection, control and metering functions are rotating phasors that maintain the correct phase angle relationships with each other at all times.

For display and oscillography purposes, all phasor angles in a given relay are referred to an AC input channel pre-selected by the **SETTINGS** ⇒ **SYSTEM SETUP** ⇒ **POWER SYSTEM** ⇒ **FREQUENCY AND PHASE REFERENCE** setting. This setting defines a particular source to be used as the reference.

The relay will first determine if any “Phase VT” bank is indicated in the Source. If it is, voltage channel VA of that bank is used as the angle reference. Otherwise, the relay determines if any “Aux VT” bank is indicated; if it is, the auxiliary voltage channel of that bank is used as the angle reference. If neither of the two conditions is satisfied, then two more steps of this hierarchical procedure to determine the reference signal include “Phase CT” bank and “Ground CT” bank.

If the AC signal pre-selected by the relay upon configuration is not measurable, the phase angles are not referenced. The phase angles are assigned as positive in the leading direction, and are presented as negative in the lagging direction, to more closely align with power system metering conventions. This is illustrated below.

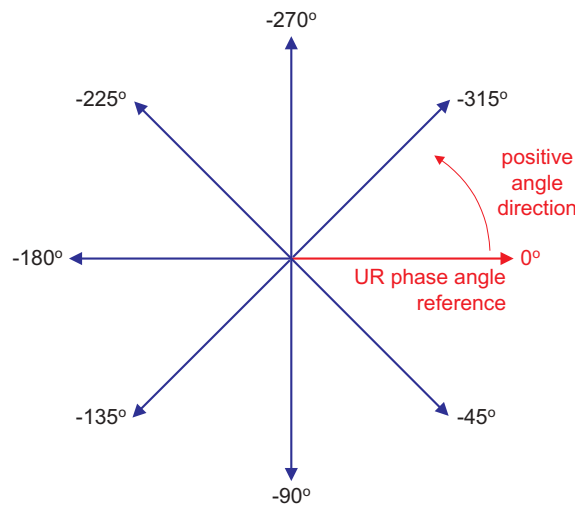

Figure 6–2: UR PHASE ANGLE MEASUREMENT CONVENTION

c) UR CONVENTION FOR MEASURING SYMMETRICAL COMPONENTS

The UR-series of relays calculate voltage symmetrical components for the power system phase A line-to-neutral voltage, and symmetrical components of the currents for the power system phase A current. Owing to the above definition, phase angle relations between the symmetrical currents and voltages stay the same irrespective of the connection of instrument transformers. This is important for setting directional protection elements that use symmetrical voltages.

For display and oscillography purposes the phase angles of symmetrical components are referenced to a common reference as described in the previous sub-section.

WYE-Connected Instrument Transformers:

- ABC phase rotation:

$$V_{-0} = \frac{1}{3}(V_{AG} + V_{BG} + V_{CG})$$

$$V_{-1} = \frac{1}{3}(V_{AG} + aV_{BG} + a^2V_{CG})$$

$$V_{-2} = \frac{1}{3}(V_{AG} + a^2V_{BG} + aV_{CG})$$

- ACB phase rotation:

$$V_{-0} = \frac{1}{3}(V_{AG} + V_{BG} + V_{CG})$$

$$V_{-1} = \frac{1}{3}(V_{AG} + a^2V_{BG} + aV_{CG})$$

$$V_{-2} = \frac{1}{3}(V_{AG} + aV_{BG} + a^2V_{CG})$$

The above equations apply to currents as well.

DELTA-Connected Instrument Transformers:

- ABC phase rotation:

$$V_{-0} = \text{N/A}$$

$$V_{-1} = \frac{1 \angle -30^\circ}{3\sqrt{3}} (V_{AB} + aV_{BC} + a^2V_{CA})$$

$$V_{-2} = \frac{1 \angle 30^\circ}{3\sqrt{3}} (V_{AB} + a^2V_{BC} + aV_{CA})$$

- ACB phase rotation:

$$V_{-0} = \text{N/A}$$

$$V_{-1} = \frac{1 \angle 30^\circ}{3\sqrt{3}} (V_{AB} + a^2V_{BC} + aV_{CA})$$

$$V_{-2} = \frac{1 \angle -30^\circ}{3\sqrt{3}} (V_{AB} + aV_{BC} + a^2V_{CA})$$

The zero-sequence voltage is not measurable under the Delta connection of instrument transformers and is defaulted to zero. The table below shows an example of symmetrical components calculations for the ABC phase rotation.

Table 6–1: SYMMETRICAL COMPONENTS CALCULATION EXAMPLE

SYSTEM VOLTAGES, SEC. V *						VT CONN.	RELAY INPUTS, SEC. V			SYMM. COMP, SEC. V		
V _{AG}	V _{BG}	V _{CG}	V _{AB}	V _{BC}	V _{CA}		F5AC	F6AC	F7AC	V ₀	V ₁	V ₂
13.9 ∠0°	76.2 ∠-125°	79.7 ∠-250°	84.9 ∠-313°	138.3 ∠-97°	85.4 ∠-241°	WYE	13.9 ∠0°	76.2 ∠-125°	79.7 ∠-250°	19.5 ∠-192°	56.5 ∠-7°	23.3 ∠-187°
UNKNOWN (only V ₁ and V ₂ can be determined)			84.9 ∠0°	138.3 ∠-144°	85.4 ∠-288°	DELTA	84.9 ∠0°	138.3 ∠-144°	85.4 ∠-288°	N/A	56.5 ∠-54°	23.3 ∠-234°

* The power system voltages are phase-referenced – for simplicity – to V_{AG} and V_{AB}, respectively. This, however, is a relative matter. It is important to remember that the UR displays are always referenced as specified under **SETTINGS** ⇒ **SYSTEM SETUP** ⇒ **POWER SYSTEM** ⇒ **FREQUENCY AND PHASE REFERENCE**.

The example above is illustrated in the following figure.

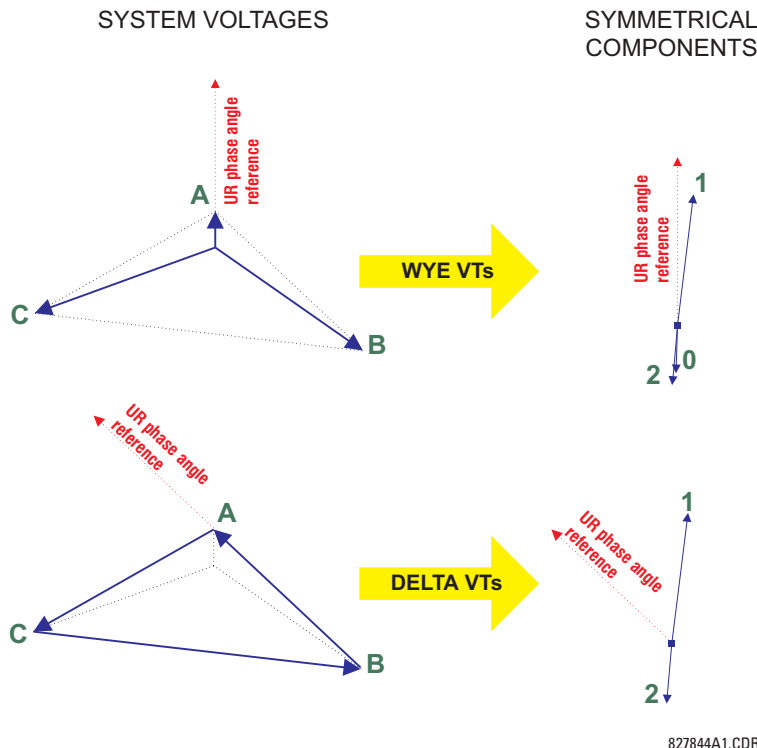

Figure 6–3: MEASUREMENT CONVENTION FOR SYMMETRICAL COMPONENTS

PATH: ACTUAL VALUES ⇒ ↓ METERING ⇒ SOURCE SRC 1 ⇒



Because energy values are accumulated, these values should be recorded and then reset immediately prior to changing CT or VT characteristics.

<ul style="list-style-type: none"> ■ PHASE CURRENT ■ SRC 1 	◀▶	SRC 1 RMS Ia: 0.000 b: 0.000 c: 0.000 A
MESSAGE	▲▼	SRC 1 RMS Ia: 0.000 A
MESSAGE	▲▼	SRC 1 RMS Ib: 0.000 A
MESSAGE	▲▼	SRC 1 RMS Ic: 0.000 A
MESSAGE	▲▼	SRC 1 RMS In: 0.000 A
MESSAGE	▲▼	SRC 1 PHASOR Ia: 0.000 A 0.0°
MESSAGE	▲▼	SRC 1 PHASOR Ib: 0.000 A 0.0°
MESSAGE	▲▼	SRC 1 PHASOR Ic: 0.000 A 0.0°
MESSAGE	▲▼	SRC 1 PHASOR In: 0.000 A 0.0°
MESSAGE	▲▼	SRC 1 ZERO SEQ I0: 0.000 A 0.0°
MESSAGE	▲▼	SRC 1 POS SEQ I1: 0.000 A 0.0°
MESSAGE	▲	SRC 1 NEG SEQ I2: 0.000 A 0.0°
▲		
<ul style="list-style-type: none"> ■ GROUND CURRENT ■ SRC 1 	◀▶	SRC 1 RMS Ig: 0.000 A
MESSAGE	▲▼	SRC 1 PHASOR Ig: 0.000 A 0.0°
MESSAGE	▲	SRC 1 PHASOR Igd: 0.000 A 0.0°
▲		
<ul style="list-style-type: none"> ■ PHASE VOLTAGE ■ SRC 1 	◀▶	SRC 1 RMS Vag: 0.000 V
MESSAGE	▲▼	SRC 1 RMS Vbg: 0.000 V
MESSAGE	▲▼	SRC 1 RMS Vcg: 0.000 V
MESSAGE	▲▼	SRC 1 PHASOR Vag: 0.000 V 0.0°

MESSAGE	▲▼	SRC 1 PHASOR V _{bg} : 0.000 V 0.0°
MESSAGE	▲▼	SRC 1 PHASOR V _{cg} : 0.000 V 0.0°
MESSAGE	▲▼	SRC 1 RMS V _{ab} : 0.000 V
MESSAGE	▲▼	SRC 1 RMS V _{bc} : 0.000 V
MESSAGE	▲▼	SRC 1 RMS V _{ca} : 0.000 V
MESSAGE	▲▼	SRC 1 PHASOR V _{ab} : 0.000 V 0.0°
MESSAGE	▲▼	SRC 1 PHASOR V _{bc} : 0.000 V 0.0°
MESSAGE	▲▼	SRC 1 PHASOR V _{ca} : 0.000 V 0.0°
MESSAGE	▲▼	SRC 1 ZERO SEQ V ₀ : 0.000 V 0.0°
MESSAGE	▲▼	SRC 1 POS SEQ V ₁ : 0.000 V 0.0°
MESSAGE	▲	SRC 1 NEG SEQ V ₂ : 0.000 V 0.0°

▲

■ AUXILIARY VOLTAGE
■ SRC 1

MESSAGE	▲	SRC 1 RMS V _x : 0.000 V
MESSAGE	▲	SRC 1 PHASOR V _x : 0.000 V 0.0°

▲

■ POWER
■ SRC 1

MESSAGE	◀▶	SRC 1 REAL POWER 3φ: 0.000 W
MESSAGE	▲▼	SRC 1 REAL POWER φ _a : 0.000 W
MESSAGE	▲▼	SRC 1 REAL POWER φ _b : 0.000 W
MESSAGE	▲▼	SRC 1 REAL POWER φ _c : 0.000 W
MESSAGE	▲▼	SRC 1 REACTIVE PWR 3φ: 0.000 var
MESSAGE	▲▼	SRC 1 REACTIVE PWR φ _a : 0.000 var
MESSAGE	▲▼	SRC 1 REACTIVE PWR φ _b : 0.000 var
MESSAGE	▲▼	SRC 1 REACTIVE PWR φ _c : 0.000 var

MESSAGE		SRC 1 APPARENT PWR 3φ: 0.000 VA
MESSAGE		SRC 1 APPARENT PWR φa: 0.000 VA
MESSAGE		SRC 1 APPARENT PWR φb: 0.000 VA
MESSAGE		SRC 1 APPARENT PWR φc: 0.000 VA
MESSAGE		SRC 1 POWER FACTOR 3φ: 1.000
MESSAGE		SRC 1 POWER FACTOR φa: 1.000
MESSAGE		SRC 1 POWER FACTOR φb: 1.000
MESSAGE		SRC 1 POWER FACTOR φc: 1.000
<div style="border: 1px solid black; padding: 2px;"> <input checked="" type="checkbox"/> ENERGY <input checked="" type="checkbox"/> SRC 1 </div>		SRC 1 POS WATTHOUR: 0.000 Wh
MESSAGE		SRC 1 NEG WATTHOUR: 0.000 Wh
MESSAGE		SRC 1 POS VARHOUR: 0.000 varh
MESSAGE		SRC 1 NEG VARHOUR: 0.000 varh
<div style="border: 1px solid black; padding: 2px;"> <input checked="" type="checkbox"/> DEMAND <input checked="" type="checkbox"/> SRC 1 </div>		SRC 1 DMD IA: 0.000 A
MESSAGE		SRC 1 DMD IA MAX: 0.000 A
MESSAGE		SRC 1 DMD IA DATE: 2001/07/31 16:30:07
MESSAGE		SRC 1 DMD IB: 0.000 A
MESSAGE		SRC 1 DMD IB MAX: 0.000 A
MESSAGE		SRC 1 DMD IB DATE: 2001/07/31 16:30:07
MESSAGE		SRC 1 DMD IC: 0.000 A
MESSAGE		SRC 1 DMD IC MAX: 0.000 A
MESSAGE		SRC 1 DMD IC DATE: 2001/07/31 16:30:07

MESSAGE	▲▼	SRC 1 DMD W: 0.000 W
MESSAGE	▲▼	SRC 1 DMD W MAX: 0.000 W
MESSAGE	▲▼	SRC 1 DMD W DATE: 2001/07/31 16:30:07
MESSAGE	▲▼	SRC 1 DMD VAR: 0.000 var
MESSAGE	▲▼	SRC 1 DMD VAR MAX: 0.000 var
MESSAGE	▲▼	SRC 1 DMD VAR DATE: 2001/07/31 16:30:07
MESSAGE	▲▼	SRC 1 DMD VA: 0.000 VA
MESSAGE	▲▼	SRC 1 DMD VA MAX: 0.000 VA
MESSAGE	▲	SRC 1 DMD VA DATE: 2001/07/31 16:30:07
	▲	
■ FREQUENCY ■ SRC 1	◀▶	SRC 1 FREQUENCY: 0.00 Hz
■ VOLTAGE HARMONICS ■ SRC 1	◀▶	SRC 1 THD Va: 0.0 Vb: 0.0 Vc: 0.0%
MESSAGE	▲▼	SRC 1 2ND Va: 0.0 Vb: 0.0 Vc: 0.0%
MESSAGE	▲▼	SRC 1 3RD Va: 0.0 Vb: 0.0 Vc: 0.0%
		↓
MESSAGE	▲	SRC 1 25TH Va: 0.0 Vb: 0.0 Vc: 0.0%

Six identical Source menus are available. The "SRC 1" text will be replaced by whatever name was programmed by the user for the associated source (see [SETTINGS](#) ⇒ [SYSTEM SETUP](#) ⇒ [SIGNAL SOURCES](#)).

The relay measures (absolute values only) **SOURCE DEMAND** on each phase and average three phase demand for real, reactive, and apparent power. These parameters can be monitored to reduce supplier demand penalties or for statistical metering purposes. Demand calculations are based on the measurement type selected in the [SETTINGS](#) ⇒ [PRODUCT SETUP](#) ⇒ [DEMAND](#) menu. For each quantity, the relay displays the demand over the most recent demand time interval, the maximum demand since the last maximum demand reset, and the time and date stamp of this maximum demand value. Maximum demand quantities can be reset to zero with the [CLEAR RECORDS](#) ⇒ [CLEAR DEMAND RECORDS](#) command.

SOURCE FREQUENCY is measured via software-implemented zero-crossing detection of an AC signal. The signal is either a Clarke transformation of three-phase voltages or currents, auxiliary voltage, or ground current as per source configuration (see the [SYSTEM SETUP](#) ⇒ [POWER SYSTEM](#) settings). The signal used for frequency estimation is low-pass filtered. The final frequency measurement is passed through a validation filter that eliminates false readings due to signal distortions and transients.

The technique used to extract the 2nd to 25th **VOLTAGE HARMONICS** is as follows. Each harmonic is computer per-phase, where:

$N = 64$ is the number of samples per cycle
 $\omega_0 = 2\pi f$ is the angular frequency based on the system frequency (50 or 60 Hz)
 $k = 1, 2, \dots, N - 1$ is the index over one cycle for the FFT
 m is the last sample number for the sliding window
 $h = 1, 2, \dots, 25$ is the harmonic number

The short-time Fourier transform is applied to the unfiltered signal:

$$\begin{aligned}
 F_{\text{real}}(m, h) &= \frac{2}{N} \sum_k (f(m-k) \cdot \cos(h \cdot \omega_0 \cdot t(k))) \\
 F_{\text{imag}}(m, h) &= \frac{2}{N} \sum_k (f(m-k) \cdot \sin(h \cdot \omega_0 \cdot t(k))) \\
 F_{\text{ampl}}(m, h) &= \sqrt{F_{\text{real}}(m, h)^2 + F_{\text{imag}}(m, h)^2}
 \end{aligned}
 \tag{EQ 6.1}$$

The harmonics are a percentage of the fundamental signal obtained by multiplying the amplitudes obtained above 100%. The total harmonic distortion (THD) is the ratio of the total harmonic content to the fundamental:

$$\text{THD} = \sqrt{F_2^2 + F_3^2 + \dots + F_{25}^2}
 \tag{EQ 6.2}$$

6.3.3 TRACKING FREQUENCY

PATH: ACTUAL VALUES ⇌ METERING ⇌ TRACKING FREQUENCY



The tracking frequency is displayed here. The frequency is tracked based on configuration of the reference source. The **TRACKING FREQUENCY** is based upon positive sequence current phasors from all line terminals and is synchronously adjusted at all terminals. If currents are below 0.125 pu, then the **NOMINAL FREQUENCY** is used.

6.3.4 FLEXELEMENTS™

PATH: ACTUAL VALUES ⇌ METERING ⇌ FLEXELEMENTS ⇌ FLEXELEMENT 1(8)



The operating signals for the FlexElements™ are displayed in pu values using the following definitions of the base units.

Table 6–2: FLEXELEMENT™ BASE UNITS

dcmA	BASE = maximum value of the DCMA INPUT MAX setting for the two transducers configured under the +IN and –IN inputs.
FREQUENCY	$f_{\text{BASE}} = 1 \text{ Hz}$
PHASE ANGLE	$\phi_{\text{BASE}} = 360 \text{ degrees}$ (see the UR angle referencing convention)
POWER FACTOR	$\text{PF}_{\text{BASE}} = 1.00$
RTDs	BASE = 100°C
SOURCE CURRENT	$I_{\text{BASE}} = \text{maximum nominal primary RMS value of the +IN and –IN inputs}$
SOURCE ENERGY (SRC X Positive and Negative Watthours); (SRC X Positive and Negative Varhours)	$E_{\text{BASE}} = 10000 \text{ MWh or MVAh, respectively}$
SOURCE POWER	$P_{\text{BASE}} = \text{maximum value of } V_{\text{BASE}} \times I_{\text{BASE}} \text{ for the +IN and –IN inputs}$
SOURCE VOLTAGE	$V_{\text{BASE}} = \text{maximum nominal primary RMS value of the +IN and –IN inputs}$

6.3.5 TRANSDUCER I/O

PATH: ACTUAL VALUES ⇒ METERING ⇒ TRANSDUCER I/O DCMA INPUTS ⇒ DCMA INPUT xx



Actual values for each dcmA input channel that is enabled are displayed with the top line as the programmed Channel ID and the bottom line as the value followed by the programmed units.

PATH: ACTUAL VALUES ⇒ METERING ⇒ TRANSDUCER I/O RTD INPUTS ⇒ RTD INPUT xx



Actual values for each RTD input channel that is enabled are displayed with the top line as the programmed Channel ID and the bottom line as the value.

6.4.1 FAULT REPORTS

PATH: ACTUAL VALUES ⇒ RECORDS ⇒ FAULT REPORTS ⇒ FAULT REPORT 1(15)

NO FAULTS TO REPORT																																				
or																																				
<input checked="" type="checkbox"/> FAULT REPORT 1	◀▶	<table border="1"> <tr> <td>FAULT 1</td> <td>LINE ID: SRC 1</td> <td>Range: SRC 1, SRC 2, SRC 3, SRC 4, SRC 5, SRC 6</td> </tr> <tr> <td>MESSAGE ▲▼</td> <td>FAULT 1 DATE:</td> <td>Range: YYYY/MM/DD</td> </tr> <tr> <td></td> <td>2000/08/11</td> <td></td> </tr> <tr> <td>MESSAGE ▲▼</td> <td>FAULT 1 TIME:</td> <td>Range: HH:MM:SS.ssssss</td> </tr> <tr> <td></td> <td>00:00:00.000000</td> <td></td> </tr> <tr> <td>MESSAGE ▲▼</td> <td>FAULT 1 TYPE:</td> <td>Range: where applicable; not seen if the source VTs are in the "Delta" configuration</td> </tr> <tr> <td></td> <td>ABG</td> <td></td> </tr> <tr> <td>MESSAGE ▲▼</td> <td>FAULT 1 LOCATION</td> <td>Range: where applicable; not seen if the source VTs are in the "Delta" configuration</td> </tr> <tr> <td></td> <td>00.0 km</td> <td></td> </tr> <tr> <td>MESSAGE ▲</td> <td>FAULT 1 RECLOSE</td> <td>Range: where applicable</td> </tr> <tr> <td></td> <td>SHOT: 0</td> <td></td> </tr> </table>	FAULT 1	LINE ID: SRC 1	Range: SRC 1, SRC 2, SRC 3, SRC 4, SRC 5, SRC 6	MESSAGE ▲▼	FAULT 1 DATE:	Range: YYYY/MM/DD		2000/08/11		MESSAGE ▲▼	FAULT 1 TIME:	Range: HH:MM:SS.ssssss		00:00:00.000000		MESSAGE ▲▼	FAULT 1 TYPE:	Range: where applicable; not seen if the source VTs are in the "Delta" configuration		ABG		MESSAGE ▲▼	FAULT 1 LOCATION	Range: where applicable; not seen if the source VTs are in the "Delta" configuration		00.0 km		MESSAGE ▲	FAULT 1 RECLOSE	Range: where applicable		SHOT: 0		
FAULT 1	LINE ID: SRC 1	Range: SRC 1, SRC 2, SRC 3, SRC 4, SRC 5, SRC 6																																		
MESSAGE ▲▼	FAULT 1 DATE:	Range: YYYY/MM/DD																																		
	2000/08/11																																			
MESSAGE ▲▼	FAULT 1 TIME:	Range: HH:MM:SS.ssssss																																		
	00:00:00.000000																																			
MESSAGE ▲▼	FAULT 1 TYPE:	Range: where applicable; not seen if the source VTs are in the "Delta" configuration																																		
	ABG																																			
MESSAGE ▲▼	FAULT 1 LOCATION	Range: where applicable; not seen if the source VTs are in the "Delta" configuration																																		
	00.0 km																																			
MESSAGE ▲	FAULT 1 RECLOSE	Range: where applicable																																		
	SHOT: 0																																			

The latest 15 fault reports can be stored. The most recent fault location calculation (when applicable) is displayed in this menu, along with the date and time stamp of the event which triggered the calculation. See the **SETTINGS ⇒ PRODUCT SETUP ⇒ FAULT REPORTS ⇒ FAULT REPORT 1(5)** menu for assigning the source and trigger for fault calculations. Refer to the **COMMANDS ⇒ CLEAR RECORDS** menu for manual clearing of the fault reports and to the **SETTINGS ⇒ PRODUCT SETUP ⇒ CLEAR RELAY RECORDS** menu for automated clearing of the fault reports.

Fault type determination is required for calculation of fault location – the algorithm uses the angle between the negative and positive sequence components of the relay currents. To improve accuracy and speed of operation, the fault components of the currents are used, i.e., the pre-fault phasors are subtracted from the measured current phasors. In addition to the angle relationships, certain extra checks are performed on magnitudes of the negative and zero-sequence currents.

The single-ended fault location method assumes that the fault components of the currents supplied from the local (A) and remote (B) systems are in phase. The figure below shows an equivalent system for fault location.

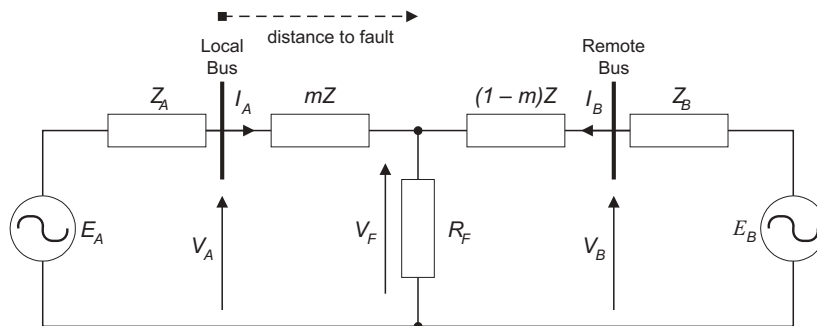

Figure 6-4: EQUIVALENT SYSTEM FOR FAULT LOCATION

The following equations hold true for this equivalent system.

$$V_A = m \cdot Z \cdot I_A + R_F \cdot (I_A + I_B) \tag{EQ 6.3}$$

where: m = sought pu distance to fault, Z = positive sequence impedance of the line.

The currents from the local and remote systems can be parted between their fault (F) and pre-fault load (pre) components:

$$I_A = I_{AF} + I_{Apre} \tag{EQ 6.4}$$

and neglecting shunt parameters of the line:

$$I_B = I_{BF} - I_{Apre} \tag{EQ 6.5}$$

Inserting the I_A and I_B equations into the V_A equation and solving for the fault resistance yields:

$$R_F = \frac{V_A - m \cdot Z \cdot I_A}{I_{AF} \cdot \left(1 + \frac{I_{BF}}{I_{AF}}\right)} \tag{EQ 6.6}$$

Assuming the fault components of the currents, I_{AF} and I_{BF} are in phase, and observing that the fault resistance, as impedance, does not have any imaginary part gives:

$$\text{Im}\left(\frac{V_A - m \cdot Z \cdot I_A}{I_{AF}}\right) = 0 \tag{EQ 6.7}$$

where: $\text{Im}()$ represents the imaginary part of a complex number. Solving the above equation for the unknown m creates the following fault location algorithm:

$$m = \frac{\text{Im}(V_A \cdot I_{AF}^*)}{\text{Im}(Z \cdot I_A \cdot I_{AF}^*)} \tag{EQ 6.8}$$

where * denotes the complex conjugate and:

$$I_{AF} = I_A - I_{Apre} \tag{EQ 6.9}$$

Depending on the fault type, appropriate voltage and current signals are selected from the phase quantities before applying the two equations above (the superscripts denote phases, the subscripts denote stations):

- For AG faults: $V_A = V_A^A$, $I_A = I_A^A + K_0 \cdot I_{0A}$
 - For BG faults: $V_A = V_A^B$, $I_A = I_A^B + K_0 \cdot I_{0A}$
 - For CG faults: $V_A = V_A^C$, $I_A = I_A^{BC} + K_0 \cdot I_{0A}$
 - For AB and ABG faults: $V_A = V_A^A - V_A^B$, $I_A = I_A^A - I_A^B$
 - For BC and BCG faults: $V_A = V_A^B - V_A^C$, $I_A = I_A^B - I_A^C$
 - For CA and CAG faults: $V_A = V_A^C - V_A^A$, $I_A = I_A^C - I_A^A$
- where K_0 is the zero sequence compensation factor (for the first six equations above)
- For ABC faults, all three AB, BC, and CA loops are analyzed and the final result is selected based upon consistency of the results

The element calculates the distance to the fault (with m in miles or kilometers) and the phases involved in the fault.

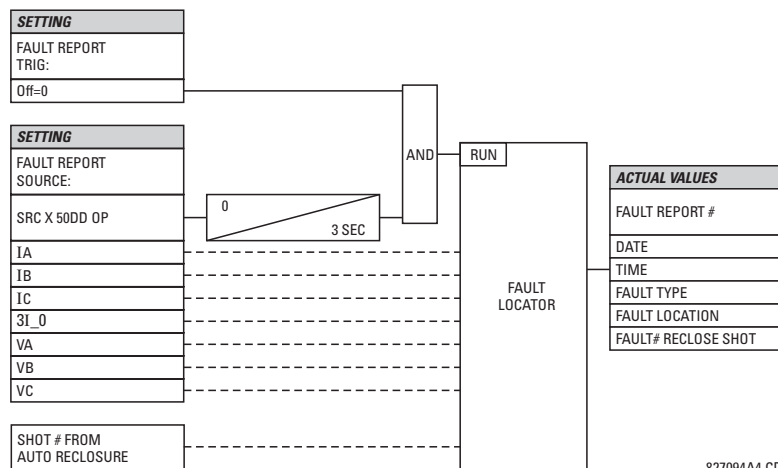
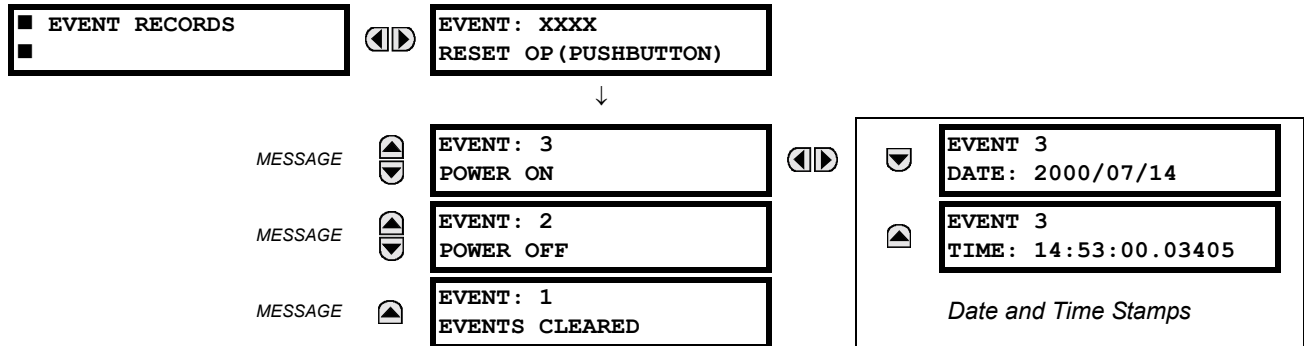

Figure 6-5: FAULT LOCATOR SCHEME

6.4.2 EVENT RECORDS

PATH: ACTUAL VALUES ⇒ RECORDS ⇒ EVENT RECORDS



The Event Records menu shows the contextual data associated with up to the last 1024 events, listed in chronological order from most recent to oldest. If all 1024 event records have been filled, the oldest record will be removed as a new record is added. Each event record shows the event identifier/sequence number, cause, and date/time stamp associated with the event trigger. Refer to the **COMMANDS** ⇒ **CLEAR RECORDS** menu for clearing event records.

6.4.3 OSCILLOGRAPHY

PATH: ACTUAL VALUES ⇒ RECORDS ⇒ OSCILLOGRAPHY

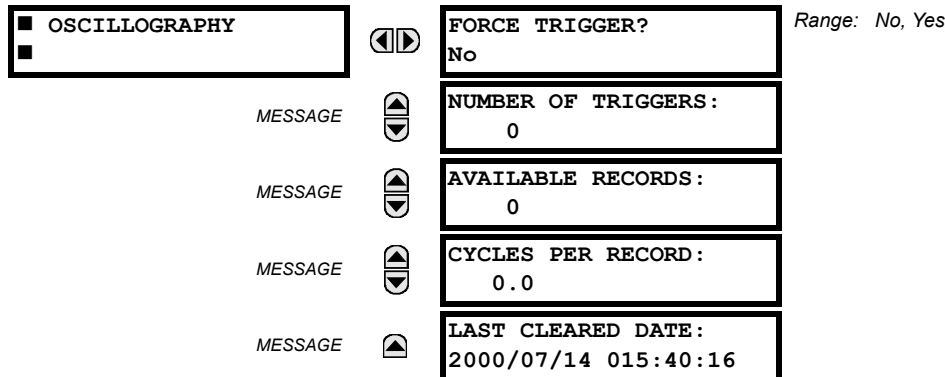

This menu allows the user to view the number of triggers involved and number of oscillography traces available. The 'cycles per record' value is calculated to account for the fixed amount of data storage for oscillography. See the Oscillography section of Chapter 5 for further details.

A trigger can be forced here at any time by setting "Yes" to the **FORCE TRIGGER?** command. Refer to the **COMMANDS** ⇒ **CLEAR RECORDS** menu for clearing the oscillography records.

6.4.4 DATA LOGGER

PATH: ACTUAL VALUES ⇒ RECORDS ⇒ DATA LOGGER

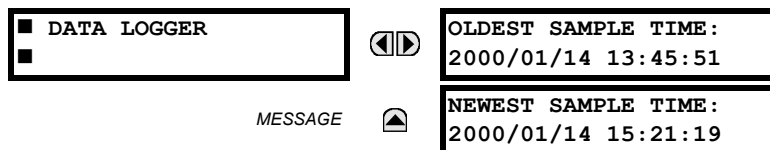

The **OLDEST SAMPLE TIME** is the time at which the oldest available samples were taken. It will be static until the log gets full, at which time it will start counting at the defined sampling rate. The **NEWEST SAMPLE TIME** is the time the most recent samples were taken. It counts up at the defined sampling rate. If Data Logger channels are defined, then both values are static.

Refer to the **COMMANDS** ⇒ **CLEAR RECORDS** menu for clearing data logger records.

6.4.5 BREAKER MAINTENANCE









PATH: ACTUAL VALUES ⇒ RECORDS ⇒ MAINTENANCE ⇒ BREAKER 1(6)

■ BREAKER 1	◀▶	BKR 1 ARCING AMP ϕ A: 0.00 kA ² -cyc
MESSAGE	▲▼	BKR 1 ARCING AMP ϕ B: 0.00 kA ² -cyc
MESSAGE	▲▼	BKR 1 ARCING AMP ϕ C: 0.00 kA ² -cyc
MESSAGE	▲▼	BKR 1 OPERATING TIME ϕ A: 0 ms
MESSAGE	▲▼	BKR 1 OPERATING TIME ϕ B: 0 ms
MESSAGE	▲▼	BKR 1 OPERATING TIME ϕ C: 0 ms
MESSAGE	▲	BKR 1 OPERATING TIME: 0 ms

There is an identical menu for each of the breakers. The **BKR 1 ARCING AMP** values are in units of kA²-cycles. Refer to the **COMMANDS ⇒ CLEAR RECORDS** menu for clearing breaker arcing current records. The **BREAKER OPERATING TIME** is defined as the slowest operating time of breaker poles that were initiated to open.

6.5.1 MODEL INFORMATION







PATH: ACTUAL VALUES ⇒ ↓ PRODUCT INFO ⇒ MODEL INFORMATION

<div style="border: 1px solid black; padding: 2px;"> ■ MODEL INFORMATION ■ </div>		ORDER CODE LINE 1 : F35-E00-HCH-F8F-H6G	<i>Example code shown</i>
MESSAGE		ORDER CODE LINE 2 :	
MESSAGE		ORDER CODE LINE 3 :	
MESSAGE		ORDER CODE LINE 4 :	
MESSAGE		SERIAL NUMBER:	
MESSAGE		ETHERNET MAC ADDRESS 000000000000	
MESSAGE		MANUFACTURING DATE : 0	<i>Range: YYYY/MM/DD HH:MM:SS</i>
MESSAGE		OPERATING TIME : 0:00:00	

The product order code, serial number, Ethernet MAC address, date/time of manufacture, and operating time are shown here.

6.5.2 FIRMWARE REVISIONS

PATH: ACTUAL VALUES ⇒ ↓ PRODUCT INFO ⇒ ↓ FIRMWARE REVISIONS

<div style="border: 1px solid black; padding: 2px;"> ■ FIRMWARE REVISIONS ■ </div>		F35 Feeder Relay REVISION: 4.40	<i>Range: 0.00 to 655.35</i> <i>Revision number of the application firmware.</i>
MESSAGE		MODIFICATION FILE NUMBER: 0	<i>Range: 0 to 65535 (ID of the MOD FILE)</i> <i>Value is 0 for each standard firmware release.</i>
MESSAGE		BOOT PROGRAM REVISION: 1.13	<i>Range: 0.00 to 655.35</i> <i>Revision number of the boot program firmware.</i>
MESSAGE		FRONT PANEL PROGRAM REVISION: 0.08	<i>Range: 0.00 to 655.35</i> <i>Revision number of faceplate program firmware.</i>
MESSAGE		COMPILE DATE : 2004/09/15 04:55:16	<i>Range: Any valid date and time.</i> <i>Date and time when product firmware was built.</i>
MESSAGE		BOOT DATE : 2004/09/15 16:41:32	<i>Range: Any valid date and time.</i> <i>Date and time when the boot program was built.</i>

The shown data is illustrative only. A modification file number of 0 indicates that, currently, no modifications have been installed.

7.1.1 COMMANDS MENU

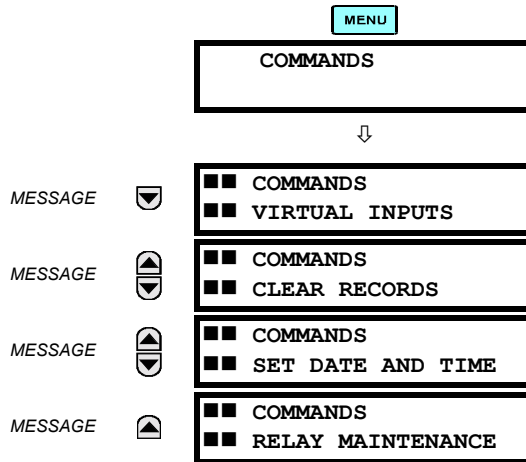

The Commands menu contains relay directives intended for operations personnel. All commands can be protected from unauthorized access via the Command Password; see the Password Security section of Chapter 5. The following flash message appears after successfully command entry:

COMMAND
EXECUTED

7.1.2 VIRTUAL INPUTS

PATH: COMMANDS ↓ COMMANDS VIRTUAL INPUTS

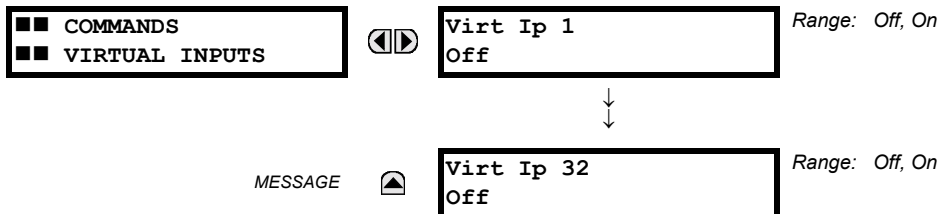

The states of up to 32 virtual inputs are changed here. The first line of the display indicates the ID of the virtual input. The second line indicates the current or selected status of the virtual input. This status will be a logical state 'Off' (0) or 'On' (1).

7.1.3 CLEAR RECORDS

PATH: COMMANDS ↓ COMMANDS CLEAR RECORDS

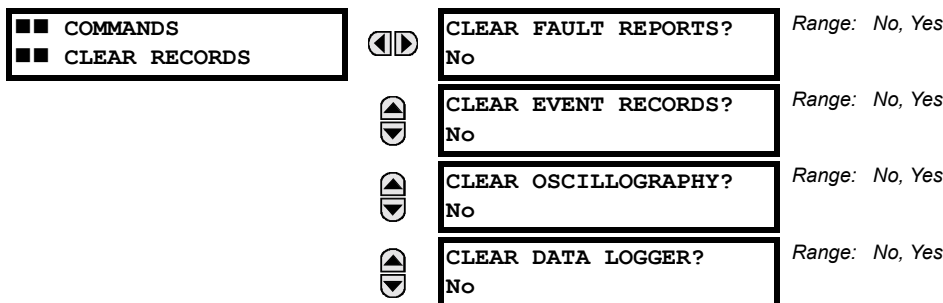

▲ ▼	CLEAR BREAKER 1 ARCING AMPS? No	Range: No, Yes
▲ ▼	CLEAR BREAKER 2 ARCING AMPS? No	Range: No, Yes
▲ ▼	CLEAR DEMAND RECORDS?: No	Range: No, Yes
▲ ▼	CLEAR ENERGY? No	Range: No, Yes
▲ ▼	CLEAR UNAUTHORIZED ACCESS? No	Range: No, Yes
▲ ▼	CLEAR DIRECT I/O COUNTERS? No	Range: No, Yes Valid only for units with Direct I/O module.
▲	CLEAR ALL RELAY RECORDS? No	Range: No, Yes

This menu contains commands for clearing historical data such as the Event Records. Data is cleared by changing a command setting to “Yes” and pressing the **ENTER** key. After clearing data, the command setting automatically reverts to “No”.

7.1.4 SET DATE AND TIME

PATH: COMMANDS ↓ SET DATE AND TIME

■ ■ COMMANDS ■ ■ SET DATE AND TIME	◀▶	SET DATE AND TIME: 2000/01/14 13:47:03	(YYYY/MM/DD HH:MM:SS)
---------------------------------------	----	---	-----------------------

The date and time can be entered here via the faceplate keypad only if the IRIG-B signal is not in use. The time setting is based on the 24-hour clock. The complete date, as a minimum, must be entered to allow execution of this command. The new time will take effect at the moment the **ENTER** key is clicked.

7.1.5 RELAY MAINTENANCE

PATH: COMMANDS ↓ RELAY MAINTENANCE

■ ■ COMMANDS ■ ■ RELAY MAINTENANCE	◀▶	PERFORM LAMPTEST? No	Range: No, Yes
	▲	UPDATE ORDER CODE? No	Range: No, Yes

This menu contains commands for relay maintenance purposes. Commands are activated by changing a command setting to “Yes” and pressing the **ENTER** key. The command setting will then automatically revert to “No”.

The **PERFORM LAMPTEST** command turns on all faceplate LEDs and display pixels for a short duration. The **UPDATE ORDER CODE** command causes the relay to scan the backplane for the hardware modules and update the order code to match. If an update occurs, the following message is shown.

UPDATING . . . PLEASE WAIT

There is no impact if there have been no changes to the hardware modules. When an update does not occur, the **ORDER CODE NOT UPDATED** message will be shown.

7.2.1 TARGETS MENU

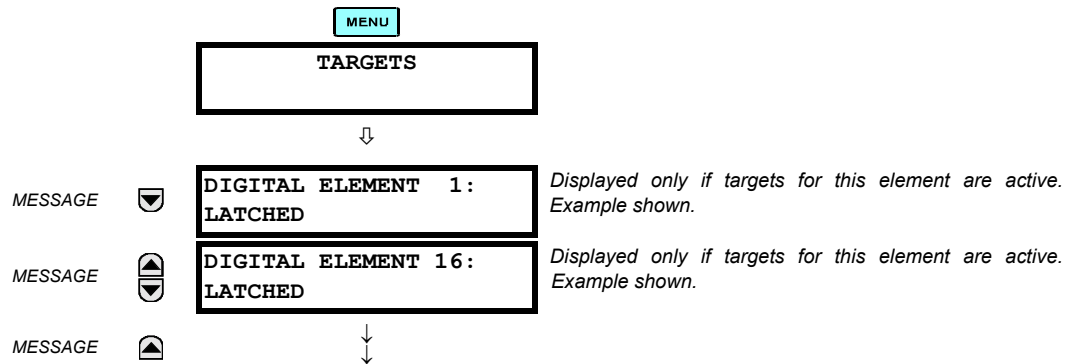

The status of any active targets will be displayed in the Targets menu. If no targets are active, the display will read **No Active Targets**:

7.2.2 TARGET MESSAGES

When there are no active targets, the first target to become active will cause the display to immediately default to that message. If there are active targets and the user is navigating through other messages, and when the default message timer times out (i.e. the keypad has not been used for a determined period of time), the display will again default back to the target message.

The range of variables for the target messages is described below. Phase information will be included if applicable. If a target message status changes, the status with the highest priority will be displayed.

Table 7-1: TARGET MESSAGE PRIORITY STATUS

PRIORITY	ACTIVE STATUS	DESCRIPTION
1	OP	element operated and still picked up
2	PKP	element picked up and timed out
3	LATCHED	element had operated but has dropped out

If a self test error is detected, a message appears indicating the cause of the error. For example **UNIT NOT PROGRAMMED** indicates that the minimal relay settings have not been programmed.

7.2.3 RELAY SELF-TESTS

The relay performs a number of self-test diagnostic checks to ensure device integrity. The two types of self-tests (major and minor) are listed in the tables below. When either type of self-test error occurs, the Trouble LED Indicator will turn on and a target message displayed. All errors record an event in the event recorder. Latched errors can be cleared by pressing the RESET key, providing the condition is no longer present.

Major self-test errors also result in the following:

- the critical fail relay on the power supply module is de-energized
- all other output relays are de-energized and are prevented from further operation
- the faceplate In Service LED indicator is turned off
- a RELAY OUT OF SERVICE event is recorded

Most of the minor self-test errors can be disabled. Refer to the settings in the User-Programmable Self-Tests section in Chapter 5 for additional details.

Table 7-2: MAJOR SELF-TEST ERROR MESSAGES

SELF-TEST ERROR MESSAGE	LATCHED TARGET MESSAGE?	DESCRIPTION OF PROBLEM	HOW OFTEN THE TEST IS PERFORMED	WHAT TO DO
DSP ERRORS: A/D Calibration, A/D Interrupt, A/D Reset, Inter DSP Rx, Sample Int, Rx Interrupt, Tx Interrupt, Rx Sample Index, Invalid Settings, Rx Checksum	Yes	CT/VT module with digital signal processor may have a problem.	Every 1/8th of a cycle.	Cycle the control power (if the problem recurs, contact the factory).
DSP ERROR: INVALID REVISION	Yes	One or more DSP modules in a multiple DSP unit has Rev. C hardware	Rev. C DSP needs to be replaced with a Rev. D DSP.	Contact the factory
EQUIPMENT MISMATCH with 2nd-line detail	No	Configuration of modules does not match the order code stored in the CPU.	On power up; thereafter, the backplane is checked for missing cards every 5 seconds.	Check all modules against the order code, ensure they are inserted properly, and cycle control power (if problem persists, contact factory).
FLEXLOGIC ERR TOKEN with 2nd-line detail	No	FlexLogic™ equations do not compile properly.	Event driven; whenever Flex-Logic™ equations are modified.	Finish all equation editing and use self test to debug any errors.
LATCHING OUTPUT ERROR	No	Discrepancy in the position of a latching contact between firmware and hardware has been detected.	Every 1/8th of a cycle.	The latching output module failed. Replace the Module.
PROGRAM MEMORY Test Failed	Yes	Error was found while checking Flash memory.	Once flash is uploaded with new firmware.	Contact the factory.
UNIT NOT CALIBRATED	No	Settings indicate the unit is not calibrated.	On power up.	Contact the factory.
UNIT NOT PROGRAMMED	No	PRODUCT SETUP ⇄ INSTALLATION setting indicates relay is not in a programmed state.	On power up and whenever the RELAY PROGRAMMED setting is altered.	Program all settings (especially those under PRODUCT SETUP ⇄ INSTALLATION).

Table 7-3: MINOR SELF-TEST ERROR MESSAGES

SELF-TEST ERROR MESSAGE	LATCHED TARGET MESSAGE	DESCRIPTION OF PROBLEM	HOW OFTEN THE TEST IS PERFORMED	WHAT TO DO
BATTERY FAIL	Yes	Battery is not functioning.	Monitored every 5 seconds. Reported after 1 minute if problem persists.	Replace the battery located in the power supply module (1H or 1L).
DIRECT RING BREAK	No	Direct input/output settings configured for a ring, but the connection is not in a ring.	Every second.	Check direct input/output configuration and/or wiring.
DIRECT DEVICE OFF	No	A direct device is configured but not connected.	Every second.	Check direct input/output configuration and/or wiring.
EEPROM DATA ERROR	Yes	The non-volatile memory has been corrupted.	On power up only.	If this message appears after an order code update is performed, press the RESET key to clear target message. In other cases, contact the factory.
IRIG-B FAILURE	No	A bad IRIG-B input signal has been detected	Monitored whenever an IRIG-B signal is received.	Ensure the IRIG-B cable is connected, check cable functionality (i.e. look for physical damage or perform continuity test), ensure IRIG-B receiver is functioning, and check input signal level (it may be less than specification). If none of these apply, contact the factory.
LATCHING OUT ERROR	Yes	Latching output failure.	Event driven.	Contact the factory.
LOW ON MEMORY	Yes	Memory is close to 100% capacity.	Monitored every 5 seconds.	Contact the factory.
PRI ETHERNET FAIL	Yes	Primary Ethernet connection failed.	Monitored every 2 seconds	Check connections.
PROTOTYPE FIRMWARE	Yes	A prototype version of the firmware is loaded.	On power up only.	Contact the factory.
REMOTE DEVICE OFF	No	One or more GOOSE devices are not responding.	Event driven – occurs when a device programmed to receive GOOSE messages stops receiving. Every 1 to 60 s, depending on GOOSE packets.	Check GOOSE setup.
SEC ETHERNET FAIL	Yes	Sec. Ethernet connection failed.	Monitored every 2 seconds	Check connections.
SNTP FAILURE	No	SNTP server not responding.	10 to 60 seconds.	Check SNTP configuration and/or network connections.
SYSTEM EXCEPTION	Yes	Abnormal restart from modules being removed/inserted when powered-up, abnormal DC supply, or internal relay failure.	Event driven.	Contact the factory.
WATCHDOG ERROR	No	Some tasks are behind schedule.	Event driven.	Contact the factory.

Table A-1: FLEXANALOG DATA ITEMS (Sheet 1 of 13)

ADDR	DATA ITEM	FLEXANALOG NAME
6144	SRC 1 Phase A Current RMS	SRC 1 Ia RMS
6146	SRC 1 Phase B Current RMS	SRC 1 Ib RMS
6148	SRC 1 Phase C Current RMS	SRC 1 Ic RMS
6150	SRC 1 Neutral Current RMS	SRC 1 In RMS
6152	SRC 1 Phase A Current Magnitude	SRC 1 Ia Mag
6154	SRC 1 Phase A Current Angle	SRC 1 Ia Angle
6155	SRC 1 Phase B Current Magnitude	SRC 1 Ib Mag
6157	SRC 1 Phase B Current Angle	SRC 1 Ib Angle
6158	SRC 1 Phase C Current Magnitude	SRC 1 Ic Mag
6160	SRC 1 Phase C Current Angle	SRC 1 Ic Angle
6161	SRC 1 Neutral Current Magnitude	SRC 1 In Mag
6163	SRC 1 Neutral Current Angle	SRC 1 In Angle
6164	SRC 1 Ground Current RMS	SRC 1 Ig RMS
6166	SRC 1 Ground Current Magnitude	SRC 1 Ig Mag
6168	SRC 1 Ground Current Angle	SRC 1 Ig Angle
6169	SRC 1 Zero Seq. Current Magnitude	SRC 1 I_0 Mag
6171	SRC 1 Zero Sequence Current Angle	SRC 1 I_0 Angle
6172	SRC 1 Pos. Seq. Current Magnitude	SRC 1 I_1 Mag
6174	SRC 1 Pos. Seq. Current Angle	SRC 1 I_1 Angle
6175	SRC 1 Neg. Seq. Current Magnitude	SRC 1 I_2 Mag
6177	SRC 1 Neg. Seq. Current Angle	SRC 1 I_2 Angle
6178	SRC 1 Differential Gnd Current Mag.	SRC 1 Igd Mag
6180	SRC 1 Diff. Gnd. Current Angle	SRC 1 Igd Angle
6208	SRC 2 Phase A Current RMS	SRC 2 Ia RMS
6210	SRC 2 Phase B Current RMS	SRC 2 Ib RMS
6212	SRC 2 Phase C Current RMS	SRC 2 Ic RMS
6214	SRC 2 Neutral Current RMS	SRC 2 In RMS
6216	SRC 2 Phase A Current Magnitude	SRC 2 Ia Mag
6218	SRC 2 Phase A Current Angle	SRC 2 Ia Angle
6219	SRC 2 Phase B Current Magnitude	SRC 2 Ib Mag
6221	SRC 2 Phase B Current Angle	SRC 2 Ib Angle
6222	SRC 2 Phase C Current Magnitude	SRC 2 Ic Mag
6224	SRC 2 Phase C Current Angle	SRC 2 Ic Angle
6225	SRC 2 Neutral Current Magnitude	SRC 2 In Mag
6227	SRC 2 Neutral Current Angle	SRC 2 In Angle
6228	SRC 2 Ground Current RMS	SRC 2 Ig RMS
6230	SRC 2 Ground Current Magnitude	SRC 2 Ig Mag
6232	SRC 2 Ground Current Angle	SRC 2 Ig Angle
6233	SRC 2 Zero Seq. Current Magnitude	SRC 2 I_0 Mag
6235	SRC 2 Zero Sequence Current Angle	SRC 2 I_0 Angle
6236	SRC 2 Pos. Seq. Current Magnitude	SRC 2 I_1 Mag
6238	SRC 2 Positive Seq. Current Angle	SRC 2 I_1 Angle
6239	SRC 2 Neg. Seq. Current Magnitude	SRC 2 I_2 Mag
6241	SRC 2 Negative Seq. Current Angle	SRC 2 I_2 Angle
6242	SRC 2 Differential Gnd Current Mag.	SRC 2 Igd Mag
6244	SRC 2 Diff. Gnd Current Angle	SRC 2 Igd Angle
6272	SRC 3 Phase A Current RMS	SRC 3 Ia RMS
6274	SRC 3 Phase B Current RMS	SRC 3 Ib RMS
6276	SRC 3 Phase C Current RMS	SRC 3 Ic RMS
6278	SRC 3 Neutral Current RMS	SRC 3 In RMS

Table A-1: FLEXANALOG DATA ITEMS (Sheet 2 of 13)

ADDR	DATA ITEM	FLEXANALOG NAME
6280	SRC 3 Phase A Current Magnitude	SRC 3 Ia Mag
6282	SRC 3 Phase A Current Angle	SRC 3 Ia Angle
6283	SRC 3 Phase B Current Magnitude	SRC 3 Ib Mag
6285	SRC 3 Phase B Current Angle	SRC 3 Ib Angle
6286	SRC 3 Phase C Current Magnitude	SRC 3 Ic Mag
6288	SRC 3 Phase C Current Angle	SRC 3 Ic Angle
6289	SRC 3 Neutral Current Magnitude	SRC 3 In Mag
6291	SRC 3 Neutral Current Angle	SRC 3 In Angle
6292	SRC 3 Ground Current RMS	SRC 3 Ig RMS
6294	SRC 3 Ground Current Magnitude	SRC 3 Ig Mag
6296	SRC 3 Ground Current Angle	SRC 3 Ig Angle
6297	SRC 3 Zero Seq. Current Magnitude	SRC 3 I_0 Mag
6299	SRC 3 Zero Sequence Current Angle	SRC 3 I_0 Angle
6300	SRC 3 Pos. Seq. Current Magnitude	SRC 3 I_1 Mag
6302	SRC 3 Positive Seq. Current Angle	SRC 3 I_1 Angle
6303	SRC 3 Neg. Seq. Current Magnitude	SRC 3 I_2 Mag
6305	SRC 3 Negative Seq. Current Angle	SRC 3 I_2 Angle
6306	SRC 3 Differential Gnd Current Mag.	SRC 3 Igd Mag
6308	SRC 3 Differential Gnd Current Angle	SRC 3 Igd Angle
6336	SRC 4 Phase A Current RMS	SRC 4 Ia RMS
6338	SRC 4 Phase B Current RMS	SRC 4 Ib RMS
6340	SRC 4 Phase C Current RMS	SRC 4 Ic RMS
6342	SRC 4 Neutral Current RMS	SRC 4 In RMS
6344	SRC 4 Phase A Current Magnitude	SRC 4 Ia Mag
6346	SRC 4 Phase A Current Angle	SRC 4 Ia Angle
6347	SRC 4 Phase B Current Magnitude	SRC 4 Ib Mag
6349	SRC 4 Phase B Current Angle	SRC 4 Ib Angle
6350	SRC 4 Phase C Current Magnitude	SRC 4 Ic Mag
6352	SRC 4 Phase C Current Angle	SRC 4 Ic Angle
6353	SRC 4 Neutral Current Magnitude	SRC 4 In Mag
6355	SRC 4 Neutral Current Angle	SRC 4 In Angle
6356	SRC 4 Ground Current RMS	SRC 4 Ig RMS
6358	SRC 4 Ground Current Magnitude	SRC 4 Ig Mag
6360	SRC 4 Ground Current Angle	SRC 4 Ig Angle
6361	SRC 4 Zero Seq. Current Magnitude	SRC 4 I_0 Mag
6363	SRC 4 Zero Seq. Current Angle	SRC 4 I_0 Angle
6364	SRC 4 Positive Seq. Current Mag.	SRC 4 I_1 Mag
6366	SRC 4 Positive Seq. Current Angle	SRC 4 I_1 Angle
6367	SRC 4 Negative Seq. Current Mag.	SRC 4 I_2 Mag
6369	SRC 4 Negative Seq. Current Angle	SRC 4 I_2 Angle
6370	SRC 4 Differential Gnd Current Mag.	SRC 4 Igd Mag
6372	SRC 4 Differential Gnd Current Angle	SRC 4 Igd Angle
6400	SRC 5 Phase A Current RMS	SRC 5 Ia RMS
6402	SRC 5 Phase B Current RMS	SRC 5 Ib RMS
6404	SRC 5 Phase C Current RMS	SRC 5 Ic RMS
6406	SRC 5 Neutral Current RMS	SRC 5 In RMS
6408	SRC 5 Phase A Current Magnitude	SRC 5 Ia Mag
6410	SRC 5 Phase A Current Angle	SRC 5 Ia Angle
6411	SRC 5 Phase B Current Magnitude	SRC 5 Ib Mag
6413	SRC 5 Phase B Current Angle	SRC 5 Ib Angle

A

Table A-1: FLEXANALOG DATA ITEMS (Sheet 3 of 13)

ADDR	DATA ITEM	FLEXANALOG NAME
6414	SRC 5 Phase C Current Magnitude	SRC 5 Ic Mag
6416	SRC 5 Phase C Current Angle	SRC 5 Ic Angle
6417	SRC 5 Neutral Current Magnitude	SRC 5 In Mag
6419	SRC 5 Neutral Current Angle	SRC 5 In Angle
6420	SRC 5 Ground Current RMS	SRC 5 Ig RMS
6422	SRC 5 Ground Current Magnitude	SRC 5 Ig Mag
6424	SRC 5 Ground Current Angle	SRC 5 Ig Angle
6425	SRC 5 Zero Seq. Current Magnitude	SRC 5 I_0 Mag
6427	SRC 5 Zero Sequence Current Angle	SRC 5 I_0 Angle
6428	SRC 5 Positive Seq. Current Mag.	SRC 5 I_1 Mag
6430	SRC 5 Positive Seq. Current Angle	SRC 5 I_1 Angle
6431	SRC 5 Negative Seq. Current Mag.	SRC 5 I_2 Mag
6433	SRC 5 Negative Seq. Current Angle	SRC 5 I_2 Angle
6434	SRC 5 Differential Gnd Current Mag.	SRC 5 Igd Mag
6436	SRC 5 Differential Gnd Current Angle	SRC 5 Igd Angle
6464	SRC 6 Phase A Current RMS	SRC 6 Ia RMS
6466	SRC 6 Phase B Current RMS	SRC 6 Ib RMS
6468	SRC 6 Phase C Current RMS	SRC 6 Ic RMS
6470	SRC 6 Neutral Current RMS	SRC 6 In RMS
6472	SRC 6 Phase A Current Magnitude	SRC 6 Ia Mag
6474	SRC 6 Phase A Current Angle	SRC 6 Ia Angle
6475	SRC 6 Phase B Current Magnitude	SRC 6 Ib Mag
6477	SRC 6 Phase B Current Angle	SRC 6 Ib Angle
6478	SRC 6 Phase C Current Magnitude	SRC 6 Ic Mag
6480	SRC 6 Phase C Current Angle	SRC 6 Ic Angle
6481	SRC 6 Neutral Current Magnitude	SRC 6 In Mag
6483	SRC 6 Neutral Current Angle	SRC 6 In Angle
6484	SRC 6 Ground Current RMS	SRC 6 Ig RMS
6486	SRC 6 Ground Current Magnitude	SRC 6 Ig Mag
6488	SRC 6 Ground Current Angle	SRC 6 Ig Angle
6489	SRC 6 Zero Seq. Current Magnitude	SRC 6 I_0 Mag
6491	SRC 6 Zero Sequence Current Angle	SRC 6 I_0 Angle
6492	SRC 6 Positive Seq. Current Mag.	SRC 6 I_1 Mag
6494	SRC 6 Positive Seq. Current Angle	SRC 6 I_1 Angle
6495	SRC 6 Negative Seq. Current Mag.	SRC 6 I_2 Mag
6497	SRC 6 Negative Seq. Current Angle	SRC 6 I_2 Angle
6498	SRC 6 Differential Gnd Current Mag.	SRC 6 Igd Mag
6500	SRC 6 Differential Gnd Current Angle	SRC 6 Igd Angle
6656	SRC 1 Phase AG Voltage RMS	SRC 1 Vag RMS
6658	SRC 1 Phase BG Voltage RMS	SRC 1 Vbg RMS
6660	SRC 1 Phase CG Voltage RMS	SRC 1 Vcg RMS
6662	SRC 1 Phase AG Voltage Magnitude	SRC 1 Vag Mag
6664	SRC 1 Phase AG Voltage Angle	SRC 1 Vag Angle
6665	SRC 1 Phase BG Voltage Magnitude	SRC 1 Vbg Mag
6667	SRC 1 Phase BG Voltage Angle	SRC 1 Vbg Angle
6668	SRC 1 Phase CG Voltage Magnitude	SRC 1 Vcg Mag
6670	SRC 1 Phase CG Voltage Angle	SRC 1 Vcg Angle
6671	SRC 1 Phase AB Voltage RMS	SRC 1 Vab RMS
6673	SRC 1 Phase BC Voltage RMS	SRC 1 Vbc RMS
6675	SRC 1 Phase CA Voltage RMS	SRC 1 Vca RMS
6677	SRC 1 Phase AB Voltage Magnitude	SRC 1 Vab Mag
6679	SRC 1 Phase AB Voltage Angle	SRC 1 Vab Angle

Table A-1: FLEXANALOG DATA ITEMS (Sheet 4 of 13)

ADDR	DATA ITEM	FLEXANALOG NAME
6680	SRC 1 Phase BC Voltage Magnitude	SRC 1 Vbc Mag
6682	SRC 1 Phase BC Voltage Angle	SRC 1 Vbc Angle
6683	SRC 1 Phase CA Voltage Magnitude	SRC 1 Vca Mag
6685	SRC 1 Phase CA Voltage Angle	SRC 1 Vca Angle
6686	SRC 1 Auxiliary Voltage RMS	SRC 1 Vx RMS
6688	SRC 1 Auxiliary Voltage Magnitude	SRC 1 Vx Mag
6690	SRC 1 Auxiliary Voltage Angle	SRC 1 Vx Angle
6691	SRC 1 Zero Sequence Voltage Mag.	SRC 1 V_0 Mag
6693	SRC 1 Zero Sequence Voltage Angle	SRC 1 V_0 Angle
6694	SRC 1 Positive Seq. Voltage Mag.	SRC 1 V_1 Mag
6696	SRC 1 Positive Seq. Voltage Angle	SRC 1 V_1 Angle
6697	SRC 1 Negative Seq. Voltage Mag.	SRC 1 V_2 Mag
6699	SRC 1 Negative Seq. Voltage Angle	SRC 1 V_2 Angle
6720	SRC 2 Phase AG Voltage RMS	SRC 2 Vag RMS
6722	SRC 2 Phase BG Voltage RMS	SRC 2 Vbg RMS
6724	SRC 2 Phase CG Voltage RMS	SRC 2 Vcg RMS
6726	SRC 2 Phase AG Voltage Magnitude	SRC 2 Vag Mag
6728	SRC 2 Phase AG Voltage Angle	SRC 2 Vag Angle
6729	SRC 2 Phase BG Voltage Magnitude	SRC 2 Vbg Mag
6731	SRC 2 Phase BG Voltage Angle	SRC 2 Vbg Angle
6732	SRC 2 Phase CG Voltage Magnitude	SRC 2 Vcg Mag
6734	SRC 2 Phase CG Voltage Angle	SRC 2 Vcg Angle
6735	SRC 2 Phase AB Voltage RMS	SRC 2 Vab RMS
6737	SRC 2 Phase BC Voltage RMS	SRC 2 Vbc RMS
6739	SRC 2 Phase CA Voltage RMS	SRC 2 Vca RMS
6741	SRC 2 Phase AB Voltage Magnitude	SRC 2 Vab Mag
6743	SRC 2 Phase AB Voltage Angle	SRC 2 Vab Angle
6744	SRC 2 Phase BC Voltage Magnitude	SRC 2 Vbc Mag
6746	SRC 2 Phase BC Voltage Angle	SRC 2 Vbc Angle
6747	SRC 2 Phase CA Voltage Magnitude	SRC 2 Vca Mag
6749	SRC 2 Phase CA Voltage Angle	SRC 2 Vca Angle
6750	SRC 2 Auxiliary Voltage RMS	SRC 2 Vx RMS
6752	SRC 2 Auxiliary Voltage Magnitude	SRC 2 Vx Mag
6754	SRC 2 Auxiliary Voltage Angle	SRC 2 Vx Angle
6755	SRC 2 Zero Seq. Voltage Magnitude	SRC 2 V_0 Mag
6757	SRC 2 Zero Sequence Voltage Angle	SRC 2 V_0 Angle
6758	SRC 2 Positive Seq. Voltage Mag.	SRC 2 V_1 Mag
6760	SRC 2 Positive Seq. Voltage Angle	SRC 2 V_1 Angle
6761	SRC 2 Negative Seq. Voltage Mag.	SRC 2 V_2 Mag
6763	SRC 2 Negative Seq. Voltage Angle	SRC 2 V_2 Angle
6784	SRC 3 Phase AG Voltage RMS	SRC 3 Vag RMS
6786	SRC 3 Phase BG Voltage RMS	SRC 3 Vbg RMS
6788	SRC 3 Phase CG Voltage RMS	SRC 3 Vcg RMS
6790	SRC 3 Phase AG Voltage Magnitude	SRC 3 Vag Mag
6792	SRC 3 Phase AG Voltage Angle	SRC 3 Vag Angle
6793	SRC 3 Phase BG Voltage Magnitude	SRC 3 Vbg Mag
6795	SRC 3 Phase BG Voltage Angle	SRC 3 Vbg Angle
6796	SRC 3 Phase CG Voltage Magnitude	SRC 3 Vcg Mag
6798	SRC 3 Phase CG Voltage Angle	SRC 3 Vcg Angle
6799	SRC 3 Phase AB Voltage RMS	SRC 3 Vab RMS
6801	SRC 3 Phase BC Voltage RMS	SRC 3 Vbc RMS
6803	SRC 3 Phase CA Voltage RMS	SRC 3 Vca RMS

Table A-1: FLEXANALOG DATA ITEMS (Sheet 5 of 13)

ADDR	DATA ITEM	FLEXANALOG NAME
6805	SRC 3 Phase AB Voltage Magnitude	SRC 3 Vab Mag
6807	SRC 3 Phase AB Voltage Angle	SRC 3 Vab Angle
6808	SRC 3 Phase BC Voltage Magnitude	SRC 3 Vbc Mag
6810	SRC 3 Phase BC Voltage Angle	SRC 3 Vbc Angle
6811	SRC 3 Phase CA Voltage Magnitude	SRC 3 Vca Mag
6813	SRC 3 Phase CA Voltage Angle	SRC 3 Vca Angle
6814	SRC 3 Auxiliary Voltage RMS	SRC 3 Vx RMS
6816	SRC 3 Auxiliary Voltage Magnitude	SRC 3 Vx Mag
6818	SRC 3 Auxiliary Voltage Angle	SRC 3 Vx Angle
6819	SRC 3 Zero Seq. Voltage Magnitude	SRC 3 V_0 Mag
6821	SRC 3 Zero Sequence Voltage Angle	SRC 3 V_0 Angle
6822	SRC 3 Positive Seq. Voltage Mag.	SRC 3 V_1 Mag
6824	SRC 3 Positive Seq. Voltage Angle	SRC 3 V_1 Angle
6825	SRC 3 Negative Seq. Voltage Mag.	SRC 3 V_2 Mag
6827	SRC 3 Negative Seq. Voltage Angle	SRC 3 V_2 Angle
6848	SRC 4 Phase AG Voltage RMS	SRC 4 Vag RMS
6850	SRC 4 Phase BG Voltage RMS	SRC 4 Vbg RMS
6852	SRC 4 Phase CG Voltage RMS	SRC 4 Vcg RMS
6854	SRC 4 Phase AG Voltage Magnitude	SRC 4 Vag Mag
6856	SRC 4 Phase AG Voltage Angle	SRC 4 Vag Angle
6857	SRC 4 Phase BG Voltage Magnitude	SRC 4 Vbg Mag
6859	SRC 4 Phase BG Voltage Angle	SRC 4 Vbg Angle
6860	SRC 4 Phase CG Voltage Magnitude	SRC 4 Vcg Mag
6862	SRC 4 Phase CG Voltage Angle	SRC 4 Vcg Angle
6863	SRC 4 Phase AB Voltage RMS	SRC 4 Vab RMS
6865	SRC 4 Phase BC Voltage RMS	SRC 4 Vbc RMS
6867	SRC 4 Phase CA Voltage RMS	SRC 4 Vca RMS
6869	SRC 4 Phase AB Voltage Magnitude	SRC 4 Vab Mag
6871	SRC 4 Phase AB Voltage Angle	SRC 4 Vab Angle
6872	SRC 4 Phase BC Voltage Magnitude	SRC 4 Vbc Mag
6874	SRC 4 Phase BC Voltage Angle	SRC 4 Vbc Angle
6875	SRC 4 Phase CA Voltage Magnitude	SRC 4 Vca Mag
6877	SRC 4 Phase CA Voltage Angle	SRC 4 Vca Angle
6878	SRC 4 Auxiliary Voltage RMS	SRC 4 Vx RMS
6880	SRC 4 Auxiliary Voltage Magnitude	SRC 4 Vx Mag
6882	SRC 4 Auxiliary Voltage Angle	SRC 4 Vx Angle
6883	SRC 4 Zero Seq. Voltage Magnitude	SRC 4 V_0 Mag
6885	SRC 4 Zero Sequence Voltage Angle	SRC 4 V_0 Angle
6886	SRC 4 Positive Seq. Voltage Mag.	SRC 4 V_1 Mag
6888	SRC 4 Positive Seq. Voltage Angle	SRC 4 V_1 Angle
6889	SRC 4 Negative Seq. Voltage Mag.	SRC 4 V_2 Mag
6891	SRC 4 Negative Seq. Voltage Angle	SRC 4 V_2 Angle
6912	SRC 5 Phase AG Voltage RMS	SRC 5 Vag RMS
6914	SRC 5 Phase BG Voltage RMS	SRC 5 Vbg RMS
6916	SRC 5 Phase CG Voltage RMS	SRC 5 Vcg RMS
6918	SRC 5 Phase AG Voltage Magnitude	SRC 5 Vag Mag
6920	SRC 5 Phase AG Voltage Angle	SRC 5 Vag Angle
6921	SRC 5 Phase BG Voltage Magnitude	SRC 5 Vbg Mag
6923	SRC 5 Phase BG Voltage Angle	SRC 5 Vbg Angle
6924	SRC 5 Phase CG Voltage Magnitude	SRC 5 Vcg Mag
6926	SRC 5 Phase CG Voltage Angle	SRC 5 Vcg Angle
6927	SRC 5 Phase AB Voltage RMS	SRC 5 Vab RMS

Table A-1: FLEXANALOG DATA ITEMS (Sheet 6 of 13)

ADDR	DATA ITEM	FLEXANALOG NAME
6929	SRC 5 Phase BC Voltage RMS	SRC 5 Vbc RMS
6931	SRC 5 Phase CA Voltage RMS	SRC 5 Vca RMS
6933	SRC 5 Phase AB Voltage Magnitude	SRC 5 Vab Mag
6935	SRC 5 Phase AB Voltage Angle	SRC 5 Vab Angle
6936	SRC 5 Phase BC Voltage Magnitude	SRC 5 Vbc Mag
6938	SRC 5 Phase BC Voltage Angle	SRC 5 Vbc Angle
6939	SRC 5 Phase CA Voltage Magnitude	SRC 5 Vca Mag
6941	SRC 5 Phase CA Voltage Angle	SRC 5 Vca Angle
6942	SRC 5 Auxiliary Voltage RMS	SRC 5 Vx RMS
6944	SRC 5 Auxiliary Voltage Magnitude	SRC 5 Vx Mag
6946	SRC 5 Auxiliary Voltage Angle	SRC 5 Vx Angle
6947	SRC 5 Zero Seq. Voltage Magnitude	SRC 5 V_0 Mag
6949	SRC 5 Zero Sequence Voltage Angle	SRC 5 V_0 Angle
6950	SRC 5 Positive Seq. Voltage Mag.	SRC 5 V_1 Mag
6952	SRC 5 Positive Seq. Voltage Angle	SRC 5 V_1 Angle
6953	SRC 5 Negative Seq. Voltage Mag.	SRC 5 V_2 Mag
6955	SRC 5 Negative Seq. Voltage Angle	SRC 5 V_2 Angle
6976	SRC 6 Phase AG Voltage RMS	SRC 6 Vag RMS
6978	SRC 6 Phase BG Voltage RMS	SRC 6 Vbg RMS
6980	SRC 6 Phase CG Voltage RMS	SRC 6 Vcg RMS
6982	SRC 6 Phase AG Voltage Magnitude	SRC 6 Vag Mag
6984	SRC 6 Phase AG Voltage Angle	SRC 6 Vag Angle
6985	SRC 6 Phase BG Voltage Magnitude	SRC 6 Vbg Mag
6987	SRC 6 Phase BG Voltage Angle	SRC 6 Vbg Angle
6988	SRC 6 Phase CG Voltage Magnitude	SRC 6 Vcg Mag
6990	SRC 6 Phase CG Voltage Angle	SRC 6 Vcg Angle
6991	SRC 6 Phase AB Voltage RMS	SRC 6 Vab RMS
6993	SRC 6 Phase BC Voltage RMS	SRC 6 Vbc RMS
6995	SRC 6 Phase CA Voltage RMS	SRC 6 Vca RMS
6997	SRC 6 Phase AB Voltage Magnitude	SRC 6 Vab Mag
6999	SRC 6 Phase AB Voltage Angle	SRC 6 Vab Angle
7000	SRC 6 Phase BC Voltage Magnitude	SRC 6 Vbc Mag
7002	SRC 6 Phase BC Voltage Angle	SRC 6 Vbc Angle
7003	SRC 6 Phase CA Voltage Magnitude	SRC 6 Vca Mag
7005	SRC 6 Phase CA Voltage Angle	SRC 6 Vca Angle
7006	SRC 6 Auxiliary Voltage RMS	SRC 6 Vx RMS
7008	SRC 6 Auxiliary Voltage Magnitude	SRC 6 Vx Mag
7010	SRC 6 Auxiliary Voltage Angle	SRC 6 Vx Angle
7011	SRC 6 Zero Seq. Voltage Magnitude	SRC 6 V_0 Mag
7013	SRC 6 Zero Sequence Voltage Angle	SRC 6 V_0 Angle
7014	SRC 6 Positive Seq. Voltage Mag.	SRC 6 V_1 Mag
7016	SRC 6 Positive Seq. Voltage Angle	SRC 6 V_1 Angle
7017	SRC 6 Negative Seq. Voltage Mag.	SRC 6 V_2 Mag
7019	SRC 6 Negative Seq. Voltage Angle	SRC 6 V_2 Angle
7168	SRC 1 Three Phase Real Power	SRC 1 P
7170	SRC 1 Phase A Real Power	SRC 1 Pa
7172	SRC 1 Phase B Real Power	SRC 1 Pb
7174	SRC 1 Phase C Real Power	SRC 1 Pc
7176	SRC 1 Three Phase Reactive Power	SRC 1 Q
7178	SRC 1 Phase A Reactive Power	SRC 1 Qa
7180	SRC 1 Phase B Reactive Power	SRC 1 Qb
7182	SRC 1 Phase C Reactive Power	SRC 1 Qc

A

Table A-1: FLEXANALOG DATA ITEMS (Sheet 7 of 13)

ADDR	DATA ITEM	FLEXANALOG NAME
7184	SRC 1 Three Phase Apparent Power	SRC 1 S
7186	SRC 1 Phase A Apparent Power	SRC 1 Sa
7188	SRC 1 Phase B Apparent Power	SRC 1 Sb
7190	SRC 1 Phase C Apparent Power	SRC 1 Sc
7192	SRC 1 Three Phase Power Factor	SRC 1 PF
7193	SRC 1 Phase A Power Factor	SRC 1 Phase A PF
7194	SRC 1 Phase B Power Factor	SRC 1 Phase B PF
7195	SRC 1 Phase C Power Factor	SRC 1 Phase C PF
7200	SRC 2 Three Phase Real Power	SRC 2 P
7202	SRC 2 Phase A Real Power	SRC 2 Pa
7204	SRC 2 Phase B Real Power	SRC 2 Pb
7206	SRC 2 Phase C Real Power	SRC 2 Pc
7208	SRC 2 Three Phase Reactive Power	SRC 2 Q
7210	SRC 2 Phase A Reactive Power	SRC 2 Qa
7212	SRC 2 Phase B Reactive Power	SRC 2 Qb
7214	SRC 2 Phase C Reactive Power	SRC 2 Qc
7216	SRC 2 Three Phase Apparent Power	SRC 2 S
7218	SRC 2 Phase A Apparent Power	SRC 2 Sa
7220	SRC 2 Phase B Apparent Power	SRC 2 Sb
7222	SRC 2 Phase C Apparent Power	SRC 2 Sc
7224	SRC 2 Three Phase Power Factor	SRC 2 PF
7225	SRC 2 Phase A Power Factor	SRC 2 Phase A PF
7226	SRC 2 Phase B Power Factor	SRC 2 Phase B PF
7227	SRC 2 Phase C Power Factor	SRC 2 Phase C PF
7232	SRC 3 Three Phase Real Power	SRC 3 P
7234	SRC 3 Phase A Real Power	SRC 3 Pa
7236	SRC 3 Phase B Real Power	SRC 3 Pb
7238	SRC 3 Phase C Real Power	SRC 3 Pc
7240	SRC 3 Three Phase Reactive Power	SRC 3 Q
7242	SRC 3 Phase A Reactive Power	SRC 3 Qa
7244	SRC 3 Phase B Reactive Power	SRC 3 Qb
7246	SRC 3 Phase C Reactive Power	SRC 3 Qc
7248	SRC 3 Three Phase Apparent Power	SRC 3 S
7250	SRC 3 Phase A Apparent Power	SRC 3 Sa
7252	SRC 3 Phase B Apparent Power	SRC 3 Sb
7254	SRC 3 Phase C Apparent Power	SRC 3 Sc
7256	SRC 3 Three Phase Power Factor	SRC 3 PF
7257	SRC 3 Phase A Power Factor	SRC 3 Phase A PF
7258	SRC 3 Phase B Power Factor	SRC 3 Phase B PF
7259	SRC 3 Phase C Power Factor	SRC 3 Phase C PF
7264	SRC 4 Three Phase Real Power	SRC 4 P
7266	SRC 4 Phase A Real Power	SRC 4 Pa
7268	SRC 4 Phase B Real Power	SRC 4 Pb
7270	SRC 4 Phase C Real Power	SRC 4 Pc
7272	SRC 4 Three Phase Reactive Power	SRC 4 Q
7274	SRC 4 Phase A Reactive Power	SRC 4 Qa
7276	SRC 4 Phase B Reactive Power	SRC 4 Qb
7278	SRC 4 Phase C Reactive Power	SRC 4 Qc
7280	SRC 4 Three Phase Apparent Power	SRC 4 S
7282	SRC 4 Phase A Apparent Power	SRC 4 Sa
7284	SRC 4 Phase B Apparent Power	SRC 4 Sb
7286	SRC 4 Phase C Apparent Power	SRC 4 Sc

Table A-1: FLEXANALOG DATA ITEMS (Sheet 8 of 13)

ADDR	DATA ITEM	FLEXANALOG NAME
7288	SRC 4 Three Phase Power Factor	SRC 4 PF
7289	SRC 4 Phase A Power Factor	SRC 4 Phase A PF
7290	SRC 4 Phase B Power Factor	SRC 4 Phase B PF
7291	SRC 4 Phase C Power Factor	SRC 4 Phase C PF
7296	SRC 5 Three Phase Real Power	SRC 5 P
7298	SRC 5 Phase A Real Power	SRC 5 Pa
7300	SRC 5 Phase B Real Power	SRC 5 Pb
7302	SRC 5 Phase C Real Power	SRC 5 Pc
7304	SRC 5 Three Phase Reactive Power	SRC 5 Q
7306	SRC 5 Phase A Reactive Power	SRC 5 Qa
7308	SRC 5 Phase B Reactive Power	SRC 5 Qb
7310	SRC 5 Phase C Reactive Power	SRC 5 Qc
7312	SRC 5 Three Phase Apparent Power	SRC 5 S
7314	SRC 5 Phase A Apparent Power	SRC 5 Sa
7316	SRC 5 Phase B Apparent Power	SRC 5 Sb
7318	SRC 5 Phase C Apparent Power	SRC 5 Sc
7320	SRC 5 Three Phase Power Factor	SRC 5 PF
7321	SRC 5 Phase A Power Factor	SRC 5 Phase A PF
7322	SRC 5 Phase B Power Factor	SRC 5 Phase B PF
7323	SRC 5 Phase C Power Factor	SRC 5 Phase C PF
7328	SRC 6 Three Phase Real Power	SRC 6 P
7330	SRC 6 Phase A Real Power	SRC 6 Pa
7332	SRC 6 Phase B Real Power	SRC 6 Pb
7334	SRC 6 Phase C Real Power	SRC 6 Pc
7336	SRC 6 Three Phase Reactive Power	SRC 6 Q
7338	SRC 6 Phase A Reactive Power	SRC 6 Qa
7340	SRC 6 Phase B Reactive Power	SRC 6 Qb
7342	SRC 6 Phase C Reactive Power	SRC 6 Qc
7344	SRC 6 Three Phase Apparent Power	SRC 6 S
7346	SRC 6 Phase A Apparent Power	SRC 6 Sa
7348	SRC 6 Phase B Apparent Power	SRC 6 Sb
7350	SRC 6 Phase C Apparent Power	SRC 6 Sc
7352	SRC 6 Three Phase Power Factor	SRC 6 PF
7353	SRC 6 Phase A Power Factor	SRC 6 Phase A PF
7354	SRC 6 Phase B Power Factor	SRC 6 Phase B PF
7355	SRC 6 Phase C Power Factor	SRC 6 Phase C PF
7552	SRC 1 Frequency	SRC 1 Frequency
7553	SRC 2 Frequency	SRC 2 Frequency
7554	SRC 3 Frequency	SRC 3 Frequency
7555	SRC 4 Frequency	SRC 4 Frequency
7556	SRC 5 Frequency	SRC 5 Frequency
7557	SRC 6 Frequency	SRC 6 Frequency
7680	SRC 1 Demand Ia	SRC 1 Demand Ia
7682	SRC 1 Demand Ib	SRC 1 Demand Ib
7684	SRC 1 Demand Ic	SRC 1 Demand Ic
7686	SRC 1 Demand Watt	SRC 1 Demand Watt
7688	SRC 1 Demand Var	SRC 1 Demand var
7690	SRC 1 Demand Va	SRC 1 Demand Va
7696	SRC 2 Demand Ia	SRC 2 Demand Ia
7698	SRC 2 Demand Ib	SRC 2 Demand Ib
7700	SRC 2 Demand Ic	SRC 2 Demand Ic
7702	SRC 2 Demand Watt	SRC 2 Demand Watt

Table A-1: FLEXANALOG DATA ITEMS (Sheet 9 of 13)

ADDR	DATA ITEM	FLEXANALOG NAME
7704	SRC 2 Demand Var	SRC 2 Demand var
7706	SRC 2 Demand Va	SRC 2 Demand Va
7712	SRC 3 Demand Ia	SRC 3 Demand Ia
7714	SRC 3 Demand Ib	SRC 3 Demand Ib
7716	SRC 3 Demand Ic	SRC 3 Demand Ic
7718	SRC 3 Demand Watt	SRC 3 Demand Watt
7720	SRC 3 Demand Var	SRC 3 Demand var
7722	SRC 3 Demand Va	SRC 3 Demand Va
7728	SRC 4 Demand Ia	SRC 4 Demand Ia
7730	SRC 4 Demand Ib	SRC 4 Demand Ib
7732	SRC 4 Demand Ic	SRC 4 Demand Ic
7734	SRC 4 Demand Watt	SRC 4 Demand Watt
7736	SRC 4 Demand Var	SRC 4 Demand var
7738	SRC 4 Demand Va	SRC 4 Demand Va
7744	SRC 5 Demand Ia	SRC 5 Demand Ia
7746	SRC 5 Demand Ib	SRC 5 Demand Ib
7748	SRC 5 Demand Ic	SRC 5 Demand Ic
7750	SRC 5 Demand Watt	SRC 5 Demand Watt
7752	SRC 5 Demand Var	SRC 5 Demand var
7754	SRC 5 Demand Va	SRC 5 Demand Va
7760	SRC 6 Demand Ia	SRC 6 Demand Ia
7762	SRC 6 Demand Ib	SRC 6 Demand Ib
7764	SRC 6 Demand Ic	SRC 6 Demand Ic
7766	SRC 6 Demand Watt	SRC 6 Demand Watt
7768	SRC 6 Demand Var	SRC 6 Demand var
7770	SRC 6 Demand Va	SRC 6 Demand Va
9024	Fault 1 Prefault Ph A Current Mag.	Prefault Ia Mag [0]
9026	Fault 1 Prefault Ph A Current Angle	Prefault Ia Ang [0]
9027	Fault 1 Prefault Ph B Current Mag.	Prefault Ib Mag [0]
9029	Fault 1 Prefault Ph B Current Angle	Prefault Ib Ang [0]
9030	Fault 1 Prefault Ph C Current Mag.	Prefault Ic Mag [0]
9032	Fault 1 Prefault Ph C Current Angle	Prefault Ic Ang [0]
9033	Fault 1 Prefault Ph A Voltage Mag.	Prefault Va Mag [0]
9035	Fault 1 Prefault Ph A Voltage Angle	Prefault Va Ang [0]
9036	Fault 1 Prefault Ph B Voltage Mag.	Prefault Vb Mag [0]
9038	Fault 1 Prefault Ph B Voltage Angle	Prefault Vb Ang [0]
9039	Fault 1 Prefault Ph C Voltage Mag.	Prefault Vc Mag [0]
9041	Fault 1 Prefault Ph C Voltage Angle	Prefault Vc Ang [0]
9042	Fault 1 Postfault Ph A Current Mag.	Postfault Ia Mag [0]
9044	Fault 1 Postfault Ph A Current Angle	Postfault Ia Ang [0]
9045	Fault 1 Postfault Ph B Current Mag.	Postfault Ib Mag [0]
9047	Fault 1 Postfault Ph B Current Angle	Postfault Ib Ang [0]
9048	Fault 1 Postfault Ph C Current Mag.	Postfault Ic Mag [0]
9050	Fault 1 Postfault Ph C Current Angle	Postfault Ic Ang [0]
9051	Fault 1 Postfault Ph A Voltage Mag.	Postfault Va Mag [0]
9053	Fault 1 Postfault Ph A Voltage Angle	Postfault Va Ang [0]
9054	Fault 1 Postfault Ph B Voltage Mag.	Postfault Vb Mag [0]
9056	Fault 1 Postfault Ph B Voltage Angle	Postfault Vb Ang [0]
9057	Fault 1 Postfault Ph C Voltage Mag.	Postfault Vc Mag [0]
9059	Fault 1 Postfault Ph C Voltage Angle	Postfault Vc Ang [0]
9060	Fault 1 Type	Fault Type [0]
9061	Fault 1 Location	Fault Location [0]

Table A-1: FLEXANALOG DATA ITEMS (Sheet 10 of 13)

ADDR	DATA ITEM	FLEXANALOG NAME
9062	Fault 2 Prefault Ph A Current Mag.	Prefault Ia Mag [1]
9064	Fault 2 Prefault Ph A Current Angle	Prefault Ia Ang [1]
9065	Fault 2 Prefault Ph B Current Mag.	Prefault Ib Mag [1]
9067	Fault 2 Prefault Ph B Current Angle	Prefault Ib Ang [1]
9068	Fault 2 Prefault Ph C Current Mag.	Prefault Ic Mag [1]
9070	Fault 2 Prefault Ph C Current Angle	Prefault Ic Ang [1]
9071	Fault 2 Prefault Ph A Voltage Mag.	Prefault Va Mag [1]
9073	Fault 2 Prefault Ph A Voltage Angle	Prefault Va Ang [1]
9074	Fault 2 Prefault Ph B Voltage Mag.	Prefault Vb Mag [1]
9076	Fault 2 Prefault Ph B Voltage Angle	Prefault Vb Ang [1]
9077	Fault 2 Prefault Ph C Voltage Mag.	Prefault Vc Mag [1]
9079	Fault 2 Prefault Ph C Voltage Angle	Prefault Vc Ang [1]
9080	Fault 2 Postfault Ph A Current Mag.	Postfault Ia Mag [1]
9082	Fault 2 Postfault Ph A Current Angle	Postfault Ia Ang [1]
9083	Fault 2 Postfault Ph B Current Mag.	Postfault Ib Mag [1]
9085	Fault 2 Postfault Ph B Current Angle	Postfault Ib Ang [1]
9086	Fault 2 Postfault Ph C Current Mag.	Postfault Ic Mag [1]
9088	Fault 2 Postfault Ph C Current Angle	Postfault Ic Ang [1]
9089	Fault 2 Postfault Ph A Voltage Mag.	Postfault Va Mag [1]
9091	Fault 2 Postfault Ph A Voltage Angle	Postfault Va Ang [1]
9092	Fault 2 Postfault Ph B Voltage Mag.	Postfault Vb Mag [1]
9094	Fault 2 Postfault Ph B Voltage Angle	Postfault Vb Ang [1]
9095	Fault 2 Postfault Ph C Voltage Mag.	Postfault Vc Mag [1]
9097	Fault 2 Postfault Ph C Voltage Angle	Postfault Vc Ang [1]
9098	Fault 2 Type	Fault Type [1]
9099	Fault 2 Location	Fault Location [1]
9100	Fault 3 Prefault Ph A Current Mag.	Prefault Ia Mag [2]
9102	Fault 3 Prefault Ph A Current Angle	Prefault Ia Ang [2]
9103	Fault 3 Prefault Ph B Current Mag.	Prefault Ib Mag [2]
9105	Fault 3 Prefault Ph B Current Angle	Prefault Ib Ang [2]
9106	Fault 3 Prefault Ph C Current Mag.	Prefault Ic Mag [2]
9108	Fault 3 Prefault Ph C Current Angle	Prefault Ic Ang [2]
9109	Fault 3 Prefault Ph A Voltage Mag.	Prefault Va Mag [2]
9111	Fault 3 Prefault Ph A Voltage Angle	Prefault Va Ang [2]
9112	Fault 3 Prefault Ph B Voltage Mag.	Prefault Vb Mag [2]
9114	Fault 3 Prefault Ph B Voltage Angle	Prefault Vb Ang [2]
9115	Fault 3 Prefault Ph C Voltage Mag.	Prefault Vc Mag [2]
9117	Fault 3 Prefault Ph C Voltage Angle	Prefault Vc Ang [2]
9118	Fault 3 Postfault Ph A Current Mag.	Postfault Ia Mag [2]
9120	Fault 3 Postfault Ph A Current Angle	Postfault Ia Ang [2]
9121	Fault 3 Postfault Ph B Current Mag.	Postfault Ib Mag [2]
9123	Fault 3 Postfault Ph B Current Angle	Postfault Ib Ang [2]
9124	Fault 3 Postfault Ph C Current Mag.	Postfault Ic Mag [2]
9126	Fault 3 Postfault Ph C Current Angle	Postfault Ic Ang [2]
9127	Fault 3 Postfault Ph A Voltage Mag.	Postfault Va Mag [2]
9129	Fault 3 Postfault Ph A Voltage Angle	Postfault Va Ang [2]
9130	Fault 3 Postfault Ph B Voltage Mag.	Postfault Vb Mag [2]
9132	Fault 3 Postfault Ph B Voltage Angle	Postfault Vb Ang [2]
9133	Fault 3 Postfault Ph C Voltage Mag.	Postfault Vc Mag [2]
9135	Fault 3 Postfault Ph C Voltage Angle	Postfault Vc Ang [2]
9136	Fault 3 Type	Fault Type [2]
9137	Fault 3 Location	Fault Location [2]

A

Table A-1: FLEXANALOG DATA ITEMS (Sheet 11 of 13)

ADDR	DATA ITEM	FLEXANALOG NAME
9138	Fault 4 Prefault Ph A Current Mag.	Prefault Ia Mag [3]
9140	Fault 4 Prefault Ph A Current Angle	Prefault Ia Ang [3]
9141	Fault 4 Prefault Ph B Current Mag.	Prefault Ib Mag [3]
9143	Fault 4 Prefault Ph B Current Angle	Prefault Ib Ang [3]
9144	Fault 4 Prefault Ph C Current Mag.	Prefault Ic Mag [3]
9146	Fault 4 Prefault Ph C Current Angle	Prefault Ic Ang [3]
9147	Fault 4 Prefault Ph A Voltage Mag.	Prefault Va Mag [3]
9149	Fault 4 Prefault Ph A Voltage Angle	Prefault Va Ang [3]
9150	Fault 4 Prefault Ph B Voltage Mag.	Prefault Vb Mag [3]
9152	Fault 4 Prefault Ph B Voltage Angle	Prefault Vb Ang [3]
9153	Fault 4 Prefault Ph C Voltage Mag.	Prefault Vc Mag [3]
9155	Fault 4 Prefault Ph C Voltage Angle	Prefault Vc Ang [3]
9156	Fault 4 Postfault Ph A Current Mag.	Postfault Ia Mag [3]
9158	Fault 4 Postfault Ph A Current Angle	Postfault Ia Ang [3]
9159	Fault 4 Postfault Ph B Current Mag.	Postfault Ib Mag [3]
9161	Fault 4 Postfault Ph B Current Angle	Postfault Ib Ang [3]
9162	Fault 4 Postfault Ph C Current Mag.	Postfault Ic Mag [3]
9164	Fault 4 Postfault Ph C Current Angle	Postfault Ic Ang [3]
9165	Fault 4 Postfault Ph A Voltage Mag.	Postfault Va Mag [3]
9167	Fault 4 Postfault Ph A Voltage Angle	Postfault Va Ang [3]
9168	Fault 4 Postfault Ph B Voltage Mag.	Postfault Vb Mag [3]
9170	Fault 4 Postfault Ph B Voltage Angle	Postfault Vb Ang [3]
9171	Fault 4 Postfault Ph C Voltage Mag.	Postfault Vc Mag [3]
9173	Fault 4 Postfault Ph C Voltage Angle	Postfault Vc Ang [3]
9174	Fault 4 Type	Fault Type [3]
9175	Fault 4 Location	Fault Location [3]
9176	Fault 5 Prefault Ph A Current Mag.	Prefault Ia Mag [4]
9178	Fault 5 Prefault Ph A Current Angle	Prefault Ia Ang [4]
9179	Fault 5 Prefault Ph B Current Mag.	Prefault Ib Mag [4]
9181	Fault 5 Prefault Ph B Current Angle	Prefault Ib Ang [4]
9182	Fault 5 Prefault Ph C Current Mag.	Prefault Ic Mag [4]
9184	Fault 5 Prefault Ph C Current Angle	Prefault Ic Ang [4]
9185	Fault 5 Prefault Ph A Voltage Mag.	Prefault Va Mag [4]
9187	Fault 5 Prefault Ph A Voltage Angle	Prefault Va Ang [4]
9188	Fault 5 Prefault Ph B Voltage Mag.	Prefault Vb Mag [4]
9190	Fault 5 Prefault Ph B Voltage Angle	Prefault Vb Ang [4]
9191	Fault 5 Prefault Ph C Voltage Mag.	Prefault Vc Mag [4]
9193	Fault 5 Prefault Ph C Voltage Angle	Prefault Vc Ang [4]
9194	Fault 5 Postfault Ph A Current Mag.	Postfault Ia Mag [4]
9196	Fault 5 Postfault Ph A Current Angle	Postfault Ia Ang [4]
9197	Fault 5 Postfault Ph B Current Mag.	Postfault Ib Mag [4]
9199	Fault 5 Postfault Ph B Current Angle	Postfault Ib Ang [4]
9200	Fault 5 Postfault Ph C Current Mag.	Postfault Ic Mag [4]
9202	Fault 5 Postfault Ph C Current Angle	Postfault Ic Ang [4]
9203	Fault 5 Postfault Ph A Voltage Mag.	Postfault Va Mag [4]
9205	Fault 5 Postfault Ph A Voltage Angle	Postfault Va Ang [4]
9206	Fault 5 Postfault Ph B Voltage Mag.	Postfault Vb Mag [4]
9208	Fault 5 Postfault Ph B Voltage Angle	Postfault Vb Ang [4]
9209	Fault 5 Postfault Ph C Voltage Mag.	Postfault Vc Mag [4]
9211	Fault 5 Postfault Ph C Voltage Angle	Postfault Vc Ang [4]
9212	Fault 5 Type	Fault Type [4]
9213	Fault 5 Location	Fault Location [4]

Table A-1: FLEXANALOG DATA ITEMS (Sheet 12 of 13)

ADDR	DATA ITEM	FLEXANALOG NAME
13504	DCMA Inputs 1 Value	DCMA Inputs 1 Value
13506	DCMA Inputs 2 Value	DCMA Inputs 2 Value
13508	DCMA Inputs 3 Value	DCMA Inputs 3 Value
13510	DCMA Inputs 4 Value	DCMA Inputs 4 Value
13512	DCMA Inputs 5 Value	DCMA Inputs 5 Value
13514	DCMA Inputs 6 Value	DCMA Inputs 6 Value
13516	DCMA Inputs 7 Value	DCMA Inputs 7 Value
13518	DCMA Inputs 8 Value	DCMA Inputs 8 Value
13520	DCMA Inputs 9 Value	DCMA Inputs 9 Value
13522	DCMA Inputs 10 Value	DCMA Inputs 10 Value
13524	DCMA Inputs 11 Value	DCMA Inputs 11 Value
13526	DCMA Inputs 12 Value	DCMA Inputs 12 Value
13528	DCMA Inputs 13 Value	DCMA Inputs 13 Value
13530	DCMA Inputs 14 Value	DCMA Inputs 14 Value
13532	DCMA Inputs 15 Value	DCMA Inputs 15 Value
13534	DCMA Inputs 16 Value	DCMA Inputs 16 Value
13536	DCMA Inputs 17 Value	DCMA Inputs 17 Value
13538	DCMA Inputs 18 Value	DCMA Inputs 18 Value
13540	DCMA Inputs 19 Value	DCMA Inputs 19 Value
13542	DCMA Inputs 20 Value	DCMA Inputs 20 Value
13544	DCMA Inputs 21 Value	DCMA Inputs 21 Value
13546	DCMA Inputs 22 Value	DCMA Inputs 22 Value
13548	DCMA Inputs 23 Value	DCMA Inputs 23 Value
13550	DCMA Inputs 24 Value	DCMA Inputs 24 Value
13552	RTD Inputs 1 Value	RTD Inputs 1 Value
13553	RTD Inputs 2 Value	RTD Inputs 2 Value
13554	RTD Inputs 3 Value	RTD Inputs 3 Value
13555	RTD Inputs 4 Value	RTD Inputs 4 Value
13556	RTD Inputs 5 Value	RTD Inputs 5 Value
13557	RTD Inputs 6 Value	RTD Inputs 6 Value
13558	RTD Inputs 7 Value	RTD Inputs 7 Value
13559	RTD Inputs 8 Value	RTD Inputs 8 Value
13560	RTD Inputs 9 Value	RTD Inputs 9 Value
13561	RTD Inputs 10 Value	RTD Inputs 10 Value
13562	RTD Inputs 11 Value	RTD Inputs 11 Value
13563	RTD Inputs 12 Value	RTD Inputs 12 Value
13564	RTD Inputs 13 Value	RTD Inputs 13 Value
13565	RTD Inputs 14 Value	RTD Inputs 14 Value
13566	RTD Inputs 15 Value	RTD Inputs 15 Value
13567	RTD Inputs 16 Value	RTD Inputs 16 Value
13568	RTD Inputs 17 Value	RTD Inputs 17 Value
13569	RTD Inputs 18 Value	RTD Inputs 18 Value
13570	RTD Inputs 19 Value	RTD Inputs 19 Value
13571	RTD Inputs 20 Value	RTD Inputs 20 Value
13572	RTD Inputs 21 Value	RTD Inputs 21 Value
13573	RTD Inputs 22 Value	RTD Inputs 22 Value
13574	RTD Inputs 23 Value	RTD Inputs 23 Value
13575	RTD Inputs 24 Value	RTD Inputs 24 Value
13576	RTD Inputs 25 Value	RTD Inputs 25 Value
13577	RTD Inputs 26 Value	RTD Inputs 26 Value
13578	RTD Inputs 27 Value	RTD Inputs 27 Value
13579	RTD Inputs 28 Value	RTD Inputs 28 Value

Table A-1: FLEXANALOG DATA ITEMS (Sheet 13 of 13)

ADDR	DATA ITEM	FLEXANALOG NAME
13580	RTD Inputs 29 Value	RTD Inputs 29 Value
13581	RTD Inputs 30 Value	RTD Inputs 30 Value
13582	RTD Inputs 31 Value	RTD Inputs 31 Value
13583	RTD Inputs 32 Value	RTD Inputs 32 Value
13584	RTD Inputs 33 Value	RTD Inputs 33 Value
13585	RTD Inputs 34 Value	RTD Inputs 34 Value
13586	RTD Inputs 35 Value	RTD Inputs 35 Value
13587	RTD Inputs 36 Value	RTD Inputs 36 Value
13588	RTD Inputs 37 Value	RTD Inputs 37 Value
13589	RTD Inputs 38 Value	RTD Inputs 38 Value
13590	RTD Inputs 39 Value	RTD Inputs 39 Value
13591	RTD Inputs 40 Value	RTD Inputs 40 Value
13592	RTD Inputs 41 Value	RTD Inputs 41 Value
13593	RTD Inputs 42 Value	RTD Inputs 42 Value
13594	RTD Inputs 43 Value	RTD Inputs 43 Value
13595	RTD Inputs 44 Value	RTD Inputs 44 Value
13596	RTD Inputs 45 Value	RTD Inputs 45 Value
13597	RTD Inputs 46 Value	RTD Inputs 46 Value
13598	RTD Inputs 47 Value	RTD Inputs 47 Value
13599	RTD Inputs 48 Value	RTD Inputs 48 Value
32768	Tracking Frequency	Tracking Frequency
39425	FlexElement 1 Actual	FlexElement 1 Value
39427	FlexElement 2 Actual	FlexElement 2 Value
39429	FlexElement 3 Actual	FlexElement 3 Value
39431	FlexElement 4 Actual	FlexElement 4 Value
39433	FlexElement 5 Actual	FlexElement 5 Value
39435	FlexElement 6 Actual	FlexElement 6 Value
39437	FlexElement 7 Actual	FlexElement 7 Value
39439	FlexElement 8 Actual	FlexElement 8 Value
39441	FlexElement 9 Actual	FlexElement 9 Value
39443	FlexElement 10 Actual	FlexElement 10 Value
39445	FlexElement 11 Actual	FlexElement 11 Value
39447	FlexElement 12 Actual	FlexElement 12 Value
39449	FlexElement 13 Actual	FlexElement 13 Value
39451	FlexElement 14 Actual	FlexElement 14 Value
39453	FlexElement 15 Actual	FlexElement 15 Value
39455	FlexElement 16 Actual	FlexElement 16 Value
40971	Current Setting Group	Active Setting Group

A

B.1.1 INTRODUCTION

The UR-series relays support a number of communications protocols to allow connection to equipment such as personal computers, RTUs, SCADA masters, and programmable logic controllers. The Modicon Modbus RTU protocol is the most basic protocol supported by the UR. Modbus is available via RS232 or RS485 serial links or via ethernet (using the Modbus/TCP specification). The following description is intended primarily for users who wish to develop their own master communication drivers and applies to the serial Modbus RTU protocol. Note that:

- The UR always acts as a slave device, meaning that it never initiates communications; it only listens and responds to requests issued by a master computer.
- For Modbus[®], a subset of the Remote Terminal Unit (RTU) protocol format is supported that allows extensive monitoring, programming, and control functions using read and write register commands.

B.1.2 PHYSICAL LAYER

The Modbus[®] RTU protocol is hardware-independent so that the physical layer can be any of a variety of standard hardware configurations including RS232 and RS485. The relay includes a faceplate (front panel) RS232 port and two rear terminal communications ports that may be configured as RS485, fiber optic, 10BaseT, or 10BaseF. Data flow is half-duplex in all configurations. See Chapter 3 for details on wiring.

Each data byte is transmitted in an asynchronous format consisting of 1 start bit, 8 data bits, 1 stop bit, and possibly 1 parity bit. This produces a 10 or 11 bit data frame. This can be important for transmission through modems at high bit rates (11 bit data frames are not supported by many modems at baud rates greater than 300).

The baud rate and parity are independently programmable for each communications port. Baud rates of 300, 1200, 2400, 4800, 9600, 14400, 19200, 28800, 33600, 38400, 57600, or 115200 bps are available. Even, odd, and no parity are available. Refer to the *Communications* section of Chapter 5 for further details.

The master device in any system must know the address of the slave device with which it is to communicate. The relay will not act on a request from a master if the address in the request does not match the relay's slave address (unless the address is the broadcast address – see below).

A single setting selects the slave address used for all ports, with the exception that for the faceplate port, the relay will accept any address when the Modbus[®] RTU protocol is used.

B.1.3 DATA LINK LAYER

Communications takes place in packets which are groups of asynchronously framed byte data. The master transmits a packet to the slave and the slave responds with a packet. The end of a packet is marked by 'dead-time' on the communications line. The following describes general format for both transmit and receive packets. For exact details on packet formatting, refer to subsequent sections describing each function code.

Table B-1: MODBUS PACKET FORMAT

DESCRIPTION	SIZE
SLAVE ADDRESS	1 byte
FUNCTION CODE	1 byte
DATA	N bytes
CRC	2 bytes
DEAD TIME	3.5 bytes transmission time

- **SLAVE ADDRESS:** This is the address of the slave device that is intended to receive the packet sent by the master and to perform the desired action. Each slave device on a communications bus must have a unique address to prevent bus contention. All of the relay's ports have the same address which is programmable from 1 to 254; see Chapter 5 for details. Only the addressed slave will respond to a packet that starts with its address. Note that the faceplate port is an exception to this rule; it will act on a message containing any slave address.

A master transmit packet with slave address 0 indicates a broadcast command. All slaves on the communication link take action based on the packet, but none respond to the master. Broadcast mode is only recognized when associated with Function Code 05h. For any other function code, a packet with broadcast mode slave address 0 will be ignored.

- **FUNCTION CODE:** This is one of the supported functions codes of the unit which tells the slave what action to perform. See the Supported Function Codes section for complete details. An exception response from the slave is indicated by setting the high order bit of the function code in the response packet. See the Exception Responses section for further details.
- **DATA:** This will be a variable number of bytes depending on the function code. This may include actual values, settings, or addresses sent by the master to the slave or by the slave to the master.
- **CRC:** This is a two byte error checking code. The RTU version of Modbus® includes a 16-bit cyclic redundancy check (CRC-16) with every packet which is an industry standard method used for error detection. If a Modbus slave device receives a packet in which an error is indicated by the CRC, the slave device will not act upon or respond to the packet thus preventing any erroneous operations. See the CRC-16 Algorithm section for details on calculating the CRC.
- **DEAD TIME:** A packet is terminated when no data is received for a period of 3.5 byte transmission times (about 15 ms at 2400 bps, 2 ms at 19200 bps, and 300 μs at 115200 bps). Consequently, the transmitting device must not allow gaps between bytes longer than this interval. Once the dead time has expired without a new byte transmission, all slaves start listening for a new packet from the master except for the addressed slave.

B.1.4 CRC-16 ALGORITHM

The CRC-16 algorithm essentially treats the entire data stream (data bits only; start, stop and parity ignored) as one continuous binary number. This number is first shifted left 16 bits and then divided by a characteristic polynomial (11000000000000101B). The 16 bit remainder of the division is appended to the end of the packet, MSByte first. The resulting packet including CRC, when divided by the same polynomial at the receiver will give a zero remainder if no transmission errors have occurred. This algorithm requires the characteristic polynomial to be reverse bit ordered. The most significant bit of the characteristic polynomial is dropped, since it does not affect the value of the remainder.

A C programming language implementation of the CRC algorithm will be provided upon request.

Table B-2: CRC-16 ALGORITHM

SYMBOLS:	-->	data transfer		
	A	16 bit working register		
	A _{low}	low order byte of A		
	A _{high}	high order byte of A		
	CRC	16 bit CRC-16 result		
	i,j	loop counters		
	(+)	logical EXCLUSIVE-OR operator		
	N	total number of data bytes		
	D _i	i-th data byte (i = 0 to N-1)		
	G	16 bit characteristic polynomial = 101000000000001 (binary) with MSbit dropped and bit order reversed		
	shr (x)	right shift operator (th LSbit of x is shifted into a carry flag, a '0' is shifted into the MSbit of x, all other bits are shifted right one location)		
	ALGORITHM:	1.	FFFF (hex) --> A	
2.		0 --> i		
3.		0 --> j		
4.		D _i (+) A _{low} --> A _{low}		
5.		j + 1 --> j		
6.		shr (A)		
7.		Is there a carry?	No: go to 8; Yes: G (+) A --> A and continue.	
8.		Is j = 8?	No: go to 5; Yes: continue	
9.		i + 1 --> i		
10.		Is i = N?	No: go to 3; Yes: continue	
11.		A --> CRC		

B.2.1 SUPPORTED FUNCTION CODES

Modbus[®] officially defines function codes from 1 to 127 though only a small subset is generally needed. The relay supports some of these functions, as summarized in the following table. Subsequent sections describe each function code in detail.

FUNCTION CODE		MODBUS DEFINITION	GE MULTILIN DEFINITION
HEX	DEC		
03	3	Read Holding Registers	Read Actual Values or Settings
04	4	Read Holding Registers	Read Actual Values or Settings
05	5	Force Single Coil	Execute Operation
06	6	Preset Single Register	Store Single Setting
10	16	Preset Multiple Registers	Store Multiple Settings

B.2.2 READ ACTUAL VALUES OR SETTINGS (FUNCTION CODE 03/04H)

This function code allows the master to read one or more consecutive data registers (actual values or settings) from a relay. Data registers are always 16 bit (two byte) values transmitted with high order byte first. The maximum number of registers that can be read in a single packet is 125. See the Modbus Memory Map table for exact details on the data registers.

Since some PLC implementations of Modbus[®] only support one of function codes 03h and 04h, the relay interpretation allows either function code to be used for reading one or more consecutive data registers. The data starting address will determine the type of data being read. Function codes 03h and 04h are therefore identical.

The following table shows the format of the master and slave packets. The example shows a master device requesting 3 register values starting at address 4050h from slave device 11h (17 decimal); the slave device responds with the values 40, 300, and 0 from registers 4050h, 4051h, and 4052h, respectively.

Table B-3: MASTER AND SLAVE DEVICE PACKET TRANSMISSION EXAMPLE

MASTER TRANSMISSION		SLAVE RESPONSE	
PACKET FORMAT	EXAMPLE (HEX)	PACKET FORMAT	EXAMPLE (HEX)
SLAVE ADDRESS	11	SLAVE ADDRESS	11
FUNCTION CODE	04	FUNCTION CODE	04
DATA STARTING ADDRESS - high	40	BYTE COUNT	06
DATA STARTING ADDRESS - low	50	DATA #1 - high	00
NUMBER OF REGISTERS - high	00	DATA #1 - low	28
NUMBER OF REGISTERS - low	03	DATA #2 - high	01
CRC - low	A7	DATA #2 - low	2C
CRC - high	4A	DATA #3 - high	00
		DATA #3 - low	00
		CRC - low	0D
		CRC - high	60

B.2.3 EXECUTE OPERATION (FUNCTION CODE 05H)

This function code allows the master to perform various operations in the relay. Available operations are shown in the Summary of Operation Codes table below.

The following table shows the format of the master and slave packets. The example shows a master device requesting the slave device 11H (17 dec) to perform a reset. The high and low Code Value bytes always have the values “FF” and “00” respectively and are a remnant of the original Modbus® definition of this function code.

Table B-4: MASTER AND SLAVE DEVICE PACKET TRANSMISSION EXAMPLE

MASTER TRANSMISSION		SLAVE RESPONSE	
PACKET FORMAT	EXAMPLE (HEX)	PACKET FORMAT	EXAMPLE (HEX)
SLAVE ADDRESS	11	SLAVE ADDRESS	11
FUNCTION CODE	05	FUNCTION CODE	05
OPERATION CODE - high	00	OPERATION CODE - high	00
OPERATION CODE - low	01	OPERATION CODE - low	01
CODE VALUE - high	FF	CODE VALUE - high	FF
CODE VALUE - low	00	CODE VALUE - low	00
CRC - low	DF	CRC - low	DF
CRC - high	6A	CRC - high	6A

Table B-5: SUMMARY OF OPERATION CODES FOR FUNCTION 05H

OPERATION CODE (HEX)	DEFINITION	DESCRIPTION
0000	NO OPERATION	Does not do anything.
0001	RESET	Performs the same function as the faceplate RESET key.
0005	CLEAR EVENT RECORDS	Performs the same function as the faceplate CLEAR EVENT RECORDS menu command.
0006	CLEAR OSCILLOGRAPHY	Clears all oscillography records.
1000 to 101F	VIRTUAL IN 1-32 ON/OFF	Sets the states of Virtual Inputs 1 to 32 either “ON” or “OFF”.

B.2.4 STORE SINGLE SETTING (FUNCTION CODE 06H)

This function code allows the master to modify the contents of a single setting register in an relay. Setting registers are always 16 bit (two byte) values transmitted high order byte first. The following table shows the format of the master and slave packets. The example shows a master device storing the value 200 at memory map address 4051h to slave device 11h (17 dec).

Table B-6: MASTER AND SLAVE DEVICE PACKET TRANSMISSION EXAMPLE

MASTER TRANSMISSION		SLAVE RESPONSE	
PACKET FORMAT	EXAMPLE (HEX)	PACKET FORMAT	EXAMPLE (HEX)
SLAVE ADDRESS	11	SLAVE ADDRESS	11
FUNCTION CODE	06	FUNCTION CODE	06
DATA STARTING ADDRESS - high	40	DATA STARTING ADDRESS - high	40
DATA STARTING ADDRESS - low	51	DATA STARTING ADDRESS - low	51
DATA - high	00	DATA - high	00
DATA - low	C8	DATA - low	C8
CRC - low	CE	CRC - low	CE
CRC - high	DD	CRC - high	DD

B.2.5 STORE MULTIPLE SETTINGS (FUNCTION CODE 10H)

This function code allows the master to modify the contents of a one or more consecutive setting registers in a relay. Setting registers are 16-bit (two byte) values transmitted high order byte first. The maximum number of setting registers that can be stored in a single packet is 60. The following table shows the format of the master and slave packets. The example shows a master device storing the value 200 at memory map address 4051h, and the value 1 at memory map address 4052h to slave device 11h (17 decimal).

Table B-7: MASTER AND SLAVE DEVICE PACKET TRANSMISSION EXAMPLE

MASTER TRANSMISSION		SLAVE RESPONSE	
PACKET FORMAT	EXAMPLE (HEX)	PACKET FORMAT	EXAMPLE (HEX)
SLAVE ADDRESS	11	SLAVE ADDRESS	11
FUNCTION CODE	10	FUNCTION CODE	10
DATA STARTING ADDRESS - hi	40	DATA STARTING ADDRESS - hi	40
DATA STARTING ADDRESS - lo	51	DATA STARTING ADDRESS - lo	51
NUMBER OF SETTINGS - hi	00	NUMBER OF SETTINGS - hi	00
NUMBER OF SETTINGS - lo	02	NUMBER OF SETTINGS - lo	02
BYTE COUNT	04	CRC - lo	07
DATA #1 - high order byte	00	CRC - hi	64
DATA #1 - low order byte	C8		
DATA #2 - high order byte	00		
DATA #2 - low order byte	01		
CRC - low order byte	12		
CRC - high order byte	62		

B.2.6 EXCEPTION RESPONSES

Programming or operation errors usually happen because of illegal data in a packet. These errors result in an exception response from the slave. The slave detecting one of these errors sends a response packet to the master with the high order bit of the function code set to 1.

The following table shows the format of the master and slave packets. The example shows a master device sending the unsupported function code 39h to slave device 11.

Table B-8: MASTER AND SLAVE DEVICE PACKET TRANSMISSION EXAMPLE

MASTER TRANSMISSION		SLAVE RESPONSE	
PACKET FORMAT	EXAMPLE (HEX)	PACKET FORMAT	EXAMPLE (HEX)
SLAVE ADDRESS	11	SLAVE ADDRESS	11
FUNCTION CODE	39	FUNCTION CODE	B9
CRC - low order byte	CD	ERROR CODE	01
CRC - high order byte	F2	CRC - low order byte	93
		CRC - high order byte	95

B.3.1 OBTAINING RELAY FILES VIA MODBUS

a) INTRODUCTION

The UR relay has a generic file transfer facility, meaning that you use the same method to obtain all of the different types of files from the unit. The Modbus registers that implement file transfer are found in the "Modbus File Transfer (Read/Write)" and "Modbus File Transfer (Read Only)" modules, starting at address 3100 in the Modbus Memory Map. To read a file from the UR relay, use the following steps:

1. Write the filename to the "Name of file to read" register using a write multiple registers command. If the name is shorter than 80 characters, you may write only enough registers to include all the text of the filename. Filenames are not case sensitive.
2. Repeatedly read all the registers in "Modbus File Transfer (Read Only)" using a read multiple registers command. It is not necessary to read the entire data block, since the UR relay will remember which was the last register you read. The "position" register is initially zero and thereafter indicates how many bytes (2 times the number of registers) you have read so far. The "size of..." register indicates the number of bytes of data remaining to read, to a maximum of 244.
3. Keep reading until the "size of..." register is smaller than the number of bytes you are transferring. This condition indicates end of file. Discard any bytes you have read beyond the indicated block size.
4. If you need to re-try a block, read only the "size of.." and "block of data", without reading the position. The file pointer is only incremented when you read the position register, so the same data block will be returned as was read in the previous operation. On the next read, check to see if the position is where you expect it to be, and discard the previous block if it is not (this condition would indicate that the UR relay did not process your original read request).

The UR relay retains connection-specific file transfer information, so files may be read simultaneously on multiple Modbus connections.

b) OTHER PROTOCOLS

All the files available via Modbus may also be retrieved using the standard file transfer mechanisms in other protocols (for example, TFTP or MMS).

c) COMTRADE, OSCILLOGRAPHY, AND DATA LOGGER FILES

Oscillography and data logger files are formatted using the COMTRADE file format per IEEE PC37.111 Draft 7c (02 September 1997). The files may be obtained in either text or binary COMTRADE format.

d) READING OSCILLOGRAPHY FILES

Familiarity with the oscillography feature is required to understand the following description. Refer to the Oscillography section in Chapter 5 for additional details.

The Oscillography Number of Triggers register is incremented by one every time a new oscillography file is triggered (captured) and cleared to zero when oscillography data is cleared. When a new trigger occurs, the associated oscillography file is assigned a file identifier number equal to the incremented value of this register; the newest file number is equal to the Oscillography_Number_of_Triggers register. This register can be used to determine if any new data has been captured by periodically reading it to see if the value has changed; if the number has increased then new data is available.

The Oscillography Number of Records register specifies the maximum number of files (and the number of cycles of data per file) that can be stored in memory of the relay. The Oscillography Available Records register specifies the actual number of files that are stored and still available to be read out of the relay.

Writing "Yes" (i.e. the value 1) to the Oscillography Clear Data register clears oscillography data files, clears both the Oscillography Number of Triggers and Oscillography Available Records registers to zero, and sets the Oscillography Last Cleared Date to the present date and time.

To read binary COMTRADE oscillography files, read the following filenames:

OSCnnnn . CFG and OSCnnn . DAT

Replace "nnn" with the desired oscillography trigger number. For ASCII format, use the following file names

OSCAnnnn . CFG and OSCAnnn . DAT

e) READING DATA LOGGER FILES

Familiarity with the data logger feature is required to understand this description. Refer to the Data Logger section of Chapter 5 for details. To read the entire data logger in binary COMTRADE format, read the following files.

`datalog.cfg` and `datalog.dat`

To read the entire data logger in ASCII COMTRADE format, read the following files.

`dataloga.cfg` and `dataloga.dat`

To limit the range of records to be returned in the COMTRADE files, append the following to the filename before writing it:

- To read from a specific time to the end of the log: `<space> startTime`
- To read a specific range of records: `<space> startTime <space> endTime`
- Replace `<startTime>` and `<endTime>` with Julian dates (seconds since Jan. 1 1970) as numeric text.

f) READING EVENT RECORDER FILES

To read the entire event recorder contents in ASCII format (the only available format), use the following filename:

`EVT.TXT`

To read from a specific record to the end of the log, use the following filename:

`EVTnnn.TXT` (replace `nnn` with the desired starting record number)

To read from a specific record to another specific record, use the following filename:

`EVT.TXT xxxxx yyyy` (replace `xxxxx` with the starting record number and `yyyy` with the ending record number)

B.3.2 MODBUS PASSWORD OPERATION

The COMMAND password is set up at memory location 4000. Storing a value of “0” removes COMMAND password protection. When reading the password setting, the encrypted value (zero if no password is set) is returned. COMMAND security is required to change the COMMAND password. Similarly, the SETTING password is set up at memory location 4002. These are the same settings and encrypted values found in the **SETTINGS** ⇒ **PRODUCT SETUP** ⇒ **PASSWORD SECURITY** menu via the keypad. Enabling password security for the faceplate display will also enable it for Modbus, and vice-versa.

To gain COMMAND level security access, the COMMAND password must be entered at memory location 4008. To gain SETTING level security access, the SETTING password must be entered at memory location 400A. The entered SETTING password must match the current SETTING password setting, or must be zero, to change settings or download firmware.

COMMAND and SETTING passwords each have a 30-minute timer. Each timer starts when you enter the particular password, and is re-started whenever you “use” it. For example, writing a setting re-starts the SETTING password timer and writing a command register or forcing a coil re-starts the COMMAND password timer. The value read at memory location 4010 can be used to confirm whether a COMMAND password is enabled or disabled (0 for Disabled). The value read at memory location 4011 can be used to confirm whether a SETTING password is enabled or disabled.

COMMAND or SETTING password security access is restricted to the particular port or particular TCP/IP connection on which the entry was made. Passwords must be entered when accessing the relay through other ports or connections, and the passwords must be re-entered after disconnecting and re-connecting on TCP/IP.

B.4.1 MODBUS MEMORY MAP

Table B-9: MODBUS MEMORY MAP (Sheet 1 of 36)

ADDR	REGISTER NAME	RANGE	UNITS	STEP	FORMAT	DEFAULT
Product Information (Read Only)						
0000	UR Product Type	0 to 65535	---	1	F001	0
0002	Product Version	0 to 655.35	---	0.01	F001	1
Product Information (Read Only -- Written by Factory)						
0010	Serial Number	---	---	---	F203	"0"
0020	Manufacturing Date	0 to 4294967295	---	1	F050	0
0022	Modification Number	0 to 65535	---	1	F001	0
0040	Order Code	---	---	---	F204	"Order Code x"
0090	Ethernet MAC Address	---	---	---	F072	0
0093	Reserved (13 items)	---	---	---	F001	0
00A0	CPU Module Serial Number	---	---	---	F203	(none)
00B0	CPU Supplier Serial Number	---	---	---	F203	(none)
00C0	Ethernet Sub Module Serial Number (8 items)	---	---	---	F203	(none)
Self Test Targets (Read Only)						
0200	Self Test States (2 items)	0 to 4294967295	0	1	F143	0
Front Panel (Read Only)						
0204	LED Column x State (10 items)	0 to 65535	---	1	F501	0
0220	Display Message	---	---	---	F204	(none)
0248	Last Key Pressed	0 to 47	---	1	F530	0 (None)
Keypress Emulation (Read/Write)						
0280	Simulated keypress -- write zero before each keystroke	0 to 42	---	1	F190	0 (No key -- use between real keys)
Virtual Input Commands (Read/Write Command) (32 modules)						
0400	Virtual Input 1 State	0 to 1	---	1	F108	0 (Off)
0401	...Repeated for module number 2					
0402	...Repeated for module number 3					
0403	...Repeated for module number 4					
0404	...Repeated for module number 5					
0405	...Repeated for module number 6					
0406	...Repeated for module number 7					
0407	...Repeated for module number 8					
0408	...Repeated for module number 9					
0409	...Repeated for module number 10					
040A	...Repeated for module number 11					
040B	...Repeated for module number 12					
040C	...Repeated for module number 13					
040D	...Repeated for module number 14					
040E	...Repeated for module number 15					
040F	...Repeated for module number 16					
0410	...Repeated for module number 17					
0411	...Repeated for module number 18					
0412	...Repeated for module number 19					
0413	...Repeated for module number 20					
0414	...Repeated for module number 21					
0415	...Repeated for module number 22					
0416	...Repeated for module number 23					
0417	...Repeated for module number 24					
0418	...Repeated for module number 25					
0419	...Repeated for module number 26					
041A	...Repeated for module number 27					
041B	...Repeated for module number 28					

B

Table B-9: MODBUS MEMORY MAP (Sheet 2 of 36)

ADDR	REGISTER NAME	RANGE	UNITS	STEP	FORMAT	DEFAULT
041C	...Repeated for module number 29					
041D	...Repeated for module number 30					
041E	...Repeated for module number 31					
041F	...Repeated for module number 32					
Digital Counter States (Read Only Non-Volatile) (8 modules)						
0800	Digital Counter 1 Value	-2147483647 to 2147483647	---	1	F004	0
0802	Digital Counter 1 Frozen	-2147483647 to 2147483647	---	1	F004	0
0804	Digital Counter 1 Frozen Time Stamp	0 to 4294967295	---	1	F050	0
0806	Digital Counter 1 Frozen Time Stamp us	0 to 4294967295	---	1	F003	0
0808	...Repeated for module number 2					
0810	...Repeated for module number 3					
0818	...Repeated for module number 4					
0820	...Repeated for module number 5					
0828	...Repeated for module number 6					
0830	...Repeated for module number 7					
0838	...Repeated for module number 8					
FlexStates (Read Only)						
0900	FlexState Bits (16 items)	0 to 65535	---	1	F001	0
Element States (Read Only)						
1000	Element Operate States (64 items)	0 to 65535	---	1	F502	0
User Displays Actuals (Read Only)						
1080	Formatted user-definable displays (16 items)	---	---	---	F200	(none)
Modbus User Map Actuals (Read Only)						
1200	User Map Values (256 items)	0 to 65535	---	1	F001	0
Element Targets (Read Only)						
14C0	Target Sequence	0 to 65535	---	1	F001	0
14C1	Number of Targets	0 to 65535	---	1	F001	0
Element Targets (Read/Write)						
14C2	Target to Read	0 to 65535	---	1	F001	0
Element Targets (Read Only)						
14C3	Target Message	---	---	---	F200	" "
Digital I/O States (Read Only)						
1500	Contact Input States (6 items)	0 to 65535	---	1	F500	0
1508	Virtual Input States (2 items)	0 to 65535	---	1	F500	0
1510	Contact Output States (4 items)	0 to 65535	---	1	F500	0
1518	Contact Output Current States (4 items)	0 to 65535	---	1	F500	0
1520	Contact Output Voltage States (4 items)	0 to 65535	---	1	F500	0
1528	Virtual Output States (4 items)	0 to 65535	---	1	F500	0
1530	Contact Output Detectors (4 items)	0 to 65535	---	1	F500	0
Remote Input/Output States (Read Only)						
1540	Remote Device 1 States	0 to 65535	---	1	F500	0
1542	Remote Input States (4 items)	0 to 65535	---	1	F500	0
1550	Remote Devices Online	0 to 1	---	1	F126	0 (No)
Remote Device Status (Read Only) (16 modules)						
1551	Remote Device 1 StNum	0 to 4294967295	---	1	F003	0
1553	Remote Device 1 SqNum	0 to 4294967295	---	1	F003	0
1555	...Repeated for module number 2					
1559	...Repeated for module number 3					
155D	...Repeated for module number 4					
1561	...Repeated for module number 5					
1565	...Repeated for module number 6					
1569	...Repeated for module number 7					
156D	...Repeated for module number 8					

B

Table B-9: MODBUS MEMORY MAP (Sheet 3 of 36)

ADDR	REGISTER NAME	RANGE	UNITS	STEP	FORMAT	DEFAULT
1571	...Repeated for module number 9					
1575	...Repeated for module number 10					
1579	...Repeated for module number 11					
157D	...Repeated for module number 12					
1581	...Repeated for module number 13					
1585	...Repeated for module number 14					
1589	...Repeated for module number 15					
158D	...Repeated for module number 16					
Platform Direct Input/Output States (Read Only)						
15C0	Direct Input States (6 items)	0 to 65535	---	1	F500	0
15C8	Direct Outputs Average Message Return Time 1	0 to 65535	ms	1	F001	0
15C9	Direct Outputs Average Message Return Time 2	0 to 65535	ms	1	F001	0
15CA	Direct Inputs/Outputs Unreturned Message Count - Ch. 1	0 to 65535	---	1	F001	0
15CB	Direct Inputs/Outputs Unreturned Message Count - Ch. 2	0 to 65535	---	1	F001	0
15D0	Direct Device States	0 to 65535	---	1	F500	0
15D1	Reserved	0 to 65535	---	1	F001	0
15D2	Direct Inputs/Outputs CRC Fail Count 1	0 to 65535	---	1	F001	0
15D3	Direct Inputs/Outputs CRC Fail Count 2	0 to 65535	---	1	F001	0
Ethernet Fibre Channel Status (Read/Write)						
1610	Ethernet Primary Fibre Channel Status	0 to 2	---	1	F134	0 (Fail)
1611	Ethernet Secondary Fibre Channel Status	0 to 2	---	1	F134	0 (Fail)
Data Logger Actuals (Read Only)						
1618	Data Logger Channel Count	0 to 16	CHNL	1	F001	0
1619	Time of oldest available samples	0 to 4294967295	seconds	1	F050	0
161B	Time of newest available samples	0 to 4294967295	seconds	1	F050	0
161D	Data Logger Duration	0 to 999.9	DAYS	0.1	F001	0
Source Current (Read Only) (6 modules)						
1800	Phase A Current RMS	0 to 999999.999	A	0.001	F060	0
1802	Phase B Current RMS	0 to 999999.999	A	0.001	F060	0
1804	Phase C Current RMS	0 to 999999.999	A	0.001	F060	0
1806	Neutral Current RMS	0 to 999999.999	A	0.001	F060	0
1808	Phase A Current Magnitude	0 to 999999.999	A	0.001	F060	0
180A	Phase A Current Angle	-359.9 to 0	degrees	0.1	F002	0
180B	Phase B Current Magnitude	0 to 999999.999	A	0.001	F060	0
180D	Phase B Current Angle	-359.9 to 0	degrees	0.1	F002	0
180E	Phase C Current Magnitude	0 to 999999.999	A	0.001	F060	0
1810	Phase C Current Angle	-359.9 to 0	degrees	0.1	F002	0
1811	Neutral Current Magnitude	0 to 999999.999	A	0.001	F060	0
1813	Neutral Current Angle	-359.9 to 0	degrees	0.1	F002	0
1814	Ground Current RMS	0 to 999999.999	A	0.001	F060	0
1816	Ground Current Magnitude	0 to 999999.999	A	0.001	F060	0
1818	Ground Current Angle	-359.9 to 0	degrees	0.1	F002	0
1819	Zero Sequence Current Magnitude	0 to 999999.999	A	0.001	F060	0
181B	Zero Sequence Current Angle	-359.9 to 0	degrees	0.1	F002	0
181C	Positive Sequence Current Magnitude	0 to 999999.999	A	0.001	F060	0
181E	Positive Sequence Current Angle	-359.9 to 0	degrees	0.1	F002	0
181F	Negative Sequence Current Magnitude	0 to 999999.999	A	0.001	F060	0
1821	Negative Sequence Current Angle	-359.9 to 0	degrees	0.1	F002	0
1822	Differential Ground Current Magnitude	0 to 999999.999	A	0.001	F060	0
1824	Differential Ground Current Angle	-359.9 to 0	degrees	0.1	F002	0
1825	Reserved (27 items)	---	---	---	F001	0
1840	...Repeated for module number 2					
1880	...Repeated for module number 3					
18C0	...Repeated for module number 4					

B

Table B-9: MODBUS MEMORY MAP (Sheet 4 of 36)

ADDR	REGISTER NAME	RANGE	UNITS	STEP	FORMAT	DEFAULT
1900	...Repeated for module number 5					
1940	...Repeated for module number 6					
Source Voltage (Read Only) (6 modules)						
1A00	Phase AG Voltage RMS	0 to 999999.999	V	0.001	F060	0
1A02	Phase BG Voltage RMS	0 to 999999.999	V	0.001	F060	0
1A04	Phase CG Voltage RMS	0 to 999999.999	V	0.001	F060	0
1A06	Phase AG Voltage Magnitude	0 to 999999.999	V	0.001	F060	0
1A08	Phase AG Voltage Angle	-359.9 to 0	degrees	0.1	F002	0
1A09	Phase BG Voltage Magnitude	0 to 999999.999	V	0.001	F060	0
1A0B	Phase BG Voltage Angle	-359.9 to 0	degrees	0.1	F002	0
1A0C	Phase CG Voltage Magnitude	0 to 999999.999	V	0.001	F060	0
1A0E	Phase CG Voltage Angle	-359.9 to 0	degrees	0.1	F002	0
1A0F	Phase AB or AC Voltage RMS	0 to 999999.999	V	0.001	F060	0
1A11	Phase BC or BA Voltage RMS	0 to 999999.999	V	0.001	F060	0
1A13	Phase CA or CB Voltage RMS	0 to 999999.999	V	0.001	F060	0
1A15	Phase AB or AC Voltage Magnitude	0 to 999999.999	V	0.001	F060	0
1A17	Phase AB or AC Voltage Angle	-359.9 to 0	degrees	0.1	F002	0
1A18	Phase BC or BA Voltage Magnitude	0 to 999999.999	V	0.001	F060	0
1A1A	Phase BC or BA Voltage Angle	-359.9 to 0	degrees	0.1	F002	0
1A1B	Phase CA or CB Voltage Magnitude	0 to 999999.999	V	0.001	F060	0
1A1D	Phase CA or CB Voltage Angle	-359.9 to 0	degrees	0.1	F002	0
1A1E	Auxiliary Voltage RMS	0 to 999999.999	V	0.001	F060	0
1A20	Auxiliary Voltage Magnitude	0 to 999999.999	V	0.001	F060	0
1A22	Auxiliary Voltage Angle	-359.9 to 0	degrees	0.1	F002	0
1A23	Zero Sequence Voltage Magnitude	0 to 999999.999	V	0.001	F060	0
1A25	Zero Sequence Voltage Angle	-359.9 to 0	degrees	0.1	F002	0
1A26	Positive Sequence Voltage Magnitude	0 to 999999.999	V	0.001	F060	0
1A28	Positive Sequence Voltage Angle	-359.9 to 0	degrees	0.1	F002	0
1A29	Negative Sequence Voltage Magnitude	0 to 999999.999	V	0.001	F060	0
1A2B	Negative Sequence Voltage Angle	-359.9 to 0	degrees	0.1	F002	0
1A2C	Reserved (20 items)	---	---	---	F001	0
1A40	...Repeated for module number 2					
1A80	...Repeated for module number 3					
1AC0	...Repeated for module number 4					
1B00	...Repeated for module number 5					
1B40	...Repeated for module number 6					
Source Power (Read Only) (6 modules)						
1C00	Three Phase Real Power	-1000000000000 to 1000000000000	W	0.001	F060	0
1C02	Phase A Real Power	-1000000000000 to 1000000000000	W	0.001	F060	0
1C04	Phase B Real Power	-1000000000000 to 1000000000000	W	0.001	F060	0
1C06	Phase C Real Power	-1000000000000 to 1000000000000	W	0.001	F060	0
1C08	Three Phase Reactive Power	-1000000000000 to 1000000000000	var	0.001	F060	0
1C0A	Phase A Reactive Power	-1000000000000 to 1000000000000	var	0.001	F060	0
1C0C	Phase B Reactive Power	-1000000000000 to 1000000000000	var	0.001	F060	0
1C0E	Phase C Reactive Power	-1000000000000 to 1000000000000	var	0.001	F060	0
1C10	Three Phase Apparent Power	-1000000000000 to 1000000000000	VA	0.001	F060	0
1C12	Phase A Apparent Power	-1000000000000 to 1000000000000	VA	0.001	F060	0

B

Table B-9: MODBUS MEMORY MAP (Sheet 5 of 36)

ADDR	REGISTER NAME	RANGE	UNITS	STEP	FORMAT	DEFAULT
1C14	Phase B Apparent Power	-1000000000000 to 1000000000000	VA	0.001	F060	0
1C16	Phase C Apparent Power	-1000000000000 to 1000000000000	VA	0.001	F060	0
1C18	Three Phase Power Factor	-0.999 to 1	---	0.001	F013	0
1C19	Phase A Power Factor	-0.999 to 1	---	0.001	F013	0
1C1A	Phase B Power Factor	-0.999 to 1	---	0.001	F013	0
1C1B	Phase C Power Factor	-0.999 to 1	---	0.001	F013	0
1C1C	Reserved (4 items)	---	---	---	F001	0
1C20	...Repeated for module number 2					
1C40	...Repeated for module number 3					
1C60	...Repeated for module number 4					
1C80	...Repeated for module number 5					
1CA0	...Repeated for module number 6					
Source Energy (Read Only Non-Volatile) (6 modules)						
1D00	Positive Watthour	0 to 1000000000000	Wh	0.001	F060	0
1D02	Negative Watthour	0 to 1000000000000	Wh	0.001	F060	0
1D04	Positive Varhour	0 to 1000000000000	varh	0.001	F060	0
1D06	Negative Varhour	0 to 1000000000000	varh	0.001	F060	0
1D08	Reserved (8 items)	---	---	---	F001	0
1D10	...Repeated for module number 2					
1D20	...Repeated for module number 3					
1D30	...Repeated for module number 4					
1D40	...Repeated for module number 5					
1D50	...Repeated for module number 6					
Energy Commands (Read/Write Command)						
1D60	Energy Clear Command	0 to 1	---	1	F126	0 (No)
Source Frequency (Read Only) (6 modules)						
1D80	Frequency	2 to 90	Hz	0.01	F001	0
1D81	...Repeated for module number 2					
1D82	...Repeated for module number 3					
1D83	...Repeated for module number 4					
1D84	...Repeated for module number 5					
1D85	...Repeated for module number 6					
Source Demand (Read Only) (6 modules)						
1E00	Demand Ia	0 to 999999.999	A	0.001	F060	0
1E02	Demand Ib	0 to 999999.999	A	0.001	F060	0
1E04	Demand Ic	0 to 999999.999	A	0.001	F060	0
1E06	Demand Watt	0 to 999999.999	W	0.001	F060	0
1E08	Demand Var	0 to 999999.999	var	0.001	F060	0
1E0A	Demand Va	0 to 999999.999	VA	0.001	F060	0
1E0C	Reserved (4 items)	---	---	---	F001	0
1E10	...Repeated for module number 2					
1E20	...Repeated for module number 3					
1E30	...Repeated for module number 4					
1E40	...Repeated for module number 5					
1E50	...Repeated for module number 6					
Source Demand Peaks (Read Only Non-Volatile) (6 modules)						
1E80	SRC 1 Demand Ia Max	0 to 999999.999	A	0.001	F060	0
1E82	SRC 1 Demand Ia Max Date	0 to 4294967295	---	1	F050	0
1E84	SRC 1 Demand Ib Max	0 to 999999.999	A	0.001	F060	0
1E86	SRC 1 Demand Ib Max Date	0 to 4294967295	---	1	F050	0
1E88	SRC 1 Demand Ic Max	0 to 999999.999	A	0.001	F060	0
1E8A	SRC 1 Demand Ic Max Date	0 to 4294967295	---	1	F050	0
1E8C	SRC 1 Demand Watt Max	0 to 999999.999	W	0.001	F060	0

Table B-9: MODBUS MEMORY MAP (Sheet 6 of 36)

ADDR	REGISTER NAME	RANGE	UNITS	STEP	FORMAT	DEFAULT
1E8E	SRC 1 Demand Watt Max Date	0 to 4294967295	---	1	F050	0
1E90	SRC 1 Demand Var	0 to 999999.999	var	0.001	F060	0
1E92	SRC 1 Demand Var Max Date	0 to 4294967295	---	1	F050	0
1E94	SRC 1 Demand Va Max	0 to 999999.999	VA	0.001	F060	0
1E96	SRC 1 Demand Va Max Date	0 to 4294967295	---	1	F050	0
1E98	Reserved (8 items)	---	---	---	F001	0
1EA0	...Repeated for module number 2					
1EC0	...Repeated for module number 3					
1EE0	...Repeated for module number 4					
1F00	...Repeated for module number 5					
1F20	...Repeated for module number 6					
Source Voltage THD And Harmonics (Read Only) (6 modules)						
1F80	Va THD	0 to 99.9	---	0.1	F001	0
1F81	Va Harmonics - 2nd to 25th (24 items)	0 to 99.9	---	0.1	F001	0
1F99	Vb THD	0 to 99.9	---	0.1	F001	0
1F9A	Vb Harmonics - 2nd to 25th (24 items)	0 to 99.9	---	0.1	F001	0
1FB2	Vc THD	0 to 99.9	---	0.1	F001	0
1FB3	Vc Harmonics - 2nd to 25th (24 items)	0 to 99.9	---	0.1	F001	0
1FCB	...Repeated for module number 2					
2016	...Repeated for module number 3					
2061	...Repeated for module number 4					
20AC	...Repeated for module number 5					
20F7	...Repeated for module number 6					
Breaker Arcing Current Actuals (Read Only Non-Volatile) (2 modules)						
21E0	Breaker 1 Arcing Current Phase A	0 to 99999999	kA ² -cyc	1	F060	0
21E2	Breaker 1 Arcing Current Phase B	0 to 99999999	kA ² -cyc	1	F060	0
21E4	Breaker 1 Arcing Current Phase C	0 to 99999999	kA ² -cyc	1	F060	0
21E6	Breaker 1 Operating Time Phase A	0 to 65535	ms	1	F001	0
21E7	Breaker 1 Operating Time Phase B	0 to 65535	ms	1	F001	0
21E8	Breaker 1 Operating Time Phase C	0 to 65535	ms	1	F001	0
21E9	Breaker 1 Operating Time	0 to 65535	ms	1	F001	0
21E6	...Repeated for module number 2					
Breaker Arcing Current Commands (Read/Write Command) (2 modules)						
2224	Breaker 1 Arcing Current Clear Command	0 to 1	---	1	F126	0 (No)
2225	...Repeated for module number 2					
Passwords Unauthorized Access (Read/Write Command)						
2230	Reset Unauthorized Access	0 to 1	---	1	F126	0 (No)
Fault Location (Read Only) (5 modules)						
2340	Prefault Phase A Current Magnitude	0 to 999999.999	A	0.001	F060	0
2342	Prefault Phase A Current Angle	-359.9 to 0	degrees	0.1	F002	0
2343	Prefault Phase B Current Magnitude	0 to 999999.999	A	0.001	F060	0
2345	Prefault Phase B Current Angle	-359.9 to 0	degrees	0.1	F002	0
2346	Prefault Phase C Current Magnitude	0 to 999999.999	A	0.001	F060	0
2348	Prefault Phase C Current Angle	-359.9 to 0	degrees	0.1	F002	0
2349	Prefault Phase A Voltage Magnitude	0 to 999999.999	V	0.001	F060	0
234B	Prefault Phase A Voltage Angle	-359.9 to 0	degrees	0.1	F002	0
234C	Prefault Phase B Voltage Magnitude	0 to 999999.999	V	0.001	F060	0
234E	Prefault Phase B Voltage Angle	-359.9 to 0	degrees	0.1	F002	0
234F	Prefault Phase C Voltage Magnitude	0 to 999999.999	V	0.001	F060	0
2351	Prefault Phase C Voltage Angle	-359.9 to 0	degrees	0.1	F002	0
2352	Fault 1 Phase A Current Magnitude	0 to 999999.999	A	0.001	F060	0
2354	Fault 1 Phase A Current Angle	-359.9 to 0	degrees	0.1	F002	0
2355	Fault 1 Phase B Current Magnitude	0 to 999999.999	A	0.001	F060	0
2357	Fault 1 Phase B Current Angle	-359.9 to 0	degrees	0.1	F002	0

Table B-9: MODBUS MEMORY MAP (Sheet 7 of 36)

ADDR	REGISTER NAME	RANGE	UNITS	STEP	FORMAT	DEFAULT
2358	Fault 1 Phase C Current Magnitude	0 to 999999.999	A	0.001	F060	0
235A	Fault 1 Phase C Current Angle	-359.9 to 0	degrees	0.1	F002	0
235B	Fault 1 Phase A Voltage Magnitude	0 to 999999.999	V	0.001	F060	0
235D	Fault 1 Phase A Voltage Angle	-359.9 to 0	degrees	0.1	F002	0
235E	Fault 1 Phase B Voltage Magnitude	0 to 999999.999	V	0.001	F060	0
2360	Fault 1 Phase B Voltage Angle	-359.9 to 0	degrees	0.1	F002	0
2361	Fault 1 Phase C Voltage Magnitude	0 to 999999.999	V	0.001	F060	0
2363	Fault 1 Phase C Voltage Angle	-359.9 to 0	degrees	0.1	F002	0
2364	Fault Type	0 to 11	---	1	F148	0 (NA)
2365	Fault Location based on Line length units (km or miles)	-3276.7 to 3276.7	---	0.1	F002	0
2366	...Repeated for module number 2					
238C	...Repeated for module number 3					
23B2	...Repeated for module number 4					
23D8	...Repeated for module number 5					
Autoreclose Status (Read Only) (6 modules)						
2410	Autoreclose Count	0 to 65535	---	1	F001	0
2411	...Repeated for module number 2					
2412	...Repeated for module number 3					
2413	...Repeated for module number 4					
2414	...Repeated for module number 5					
2415	...Repeated for module number 6					
Expanded FlexStates (Read Only)						
2B00	FlexStates, one per register (256 items)	0 to 1	---	1	F108	0 (Off)
Expanded Digital Input/Output states (Read Only)						
2D00	Contact Input States, one per register (96 items)	0 to 1	---	1	F108	0 (Off)
2D80	Contact Output States, one per register (64 items)	0 to 1	---	1	F108	0 (Off)
2E00	Virtual Output States, one per register (64 items)	0 to 1	---	1	F108	0 (Off)
Expanded Remote Input/Output Status (Read Only)						
2F00	Remote Device States, one per register (16 items)	0 to 1	---	1	F155	0 (Offline)
2F80	Remote Input States, one per register (64 items)	0 to 1	---	1	F108	0 (Off)
Oscillography Values (Read Only)						
3000	Oscillography Number of Triggers	0 to 65535	---	1	F001	0
3001	Oscillography Available Records	0 to 65535	---	1	F001	0
3002	Oscillography Last Cleared Date	0 to 400000000	---	1	F050	0
3004	Oscillography Number Of Cycles Per Record	0 to 65535	---	1	F001	0
Oscillography Commands (Read/Write Command)						
3005	Oscillography Force Trigger	0 to 1	---	1	F126	0 (No)
3011	Oscillography Clear Data	0 to 1	---	1	F126	0 (No)
Fault Report Indexing (Read Only Non-Volatile)						
3020	Number Of Fault Reports	0 to 65535	---	1	F001	0
Fault Report Actuals (Read Only Non-Volatile) (15 modules)						
3030	Fault Time	0 to 4294967295	---	1	F050	0
3032	...Repeated for module number 2					
3034	...Repeated for module number 3					
3036	...Repeated for module number 4					
3038	...Repeated for module number 5					
303A	...Repeated for module number 6					
303C	...Repeated for module number 7					
303E	...Repeated for module number 8					
3040	...Repeated for module number 9					
3042	...Repeated for module number 10					
3044	...Repeated for module number 11					
3046	...Repeated for module number 12					
3048	...Repeated for module number 13					

B

Table B-9: MODBUS MEMORY MAP (Sheet 8 of 36)

ADDR	REGISTER NAME	RANGE	UNITS	STEP	FORMAT	DEFAULT
304A	...Repeated for module number 14					
304C	...Repeated for module number 15					
Modbus File Transfer (Read/Write)						
3100	Name of file to read	---	---	---	F204	(none)
Modbus File Transfer (Read Only)						
3200	Character position of current block within file	0 to 4294967295	---	1	F003	0
3202	Size of currently-available data block	0 to 65535	---	1	F001	0
3203	Block of data from requested file (122 items)	0 to 65535	---	1	F001	0
Event Recorder (Read Only)						
3400	Events Since Last Clear	0 to 4294967295	---	1	F003	0
3402	Number of Available Events	0 to 4294967295	---	1	F003	0
3404	Event Recorder Last Cleared Date	0 to 4294967295	---	1	F050	0
Event Recorder (Read/Write Command)						
3406	Event Recorder Clear Command	0 to 1	---	1	F126	0 (No)
DCMA Input Values (Read Only) (24 modules)						
34C0	DCMA Inputs 1 Value	-9999.999 to 9999.999	---	0.001	F004	0
34C2	...Repeated for module number 2					
34C4	...Repeated for module number 3					
34C6	...Repeated for module number 4					
34C8	...Repeated for module number 5					
34CA	...Repeated for module number 6					
34CC	...Repeated for module number 7					
34CE	...Repeated for module number 8					
34D0	...Repeated for module number 9					
34D2	...Repeated for module number 10					
34D4	...Repeated for module number 11					
34D6	...Repeated for module number 12					
34D8	...Repeated for module number 13					
34DA	...Repeated for module number 14					
34DC	...Repeated for module number 15					
34DE	...Repeated for module number 16					
34E0	...Repeated for module number 17					
34E2	...Repeated for module number 18					
34E4	...Repeated for module number 19					
34E6	...Repeated for module number 20					
34E8	...Repeated for module number 21					
34EA	...Repeated for module number 22					
34EC	...Repeated for module number 23					
34EE	...Repeated for module number 24					
RTD Input Values (Read Only) (48 modules)						
34F0	RTD Inputs 1 Value	-32768 to 32767	°C	1	F002	0
34F1	...Repeated for module number 2					
34F2	...Repeated for module number 3					
34F3	...Repeated for module number 4					
34F4	...Repeated for module number 5					
34F5	...Repeated for module number 6					
34F6	...Repeated for module number 7					
34F7	...Repeated for module number 8					
34F8	...Repeated for module number 9					
34F9	...Repeated for module number 10					
34FA	...Repeated for module number 11					
34FB	...Repeated for module number 12					
34FC	...Repeated for module number 13					
34FD	...Repeated for module number 14					

B

Table B-9: MODBUS MEMORY MAP (Sheet 9 of 36)

ADDR	REGISTER NAME	RANGE	UNITS	STEP	FORMAT	DEFAULT
34FE	...Repeated for module number 15					
34FF	...Repeated for module number 16					
3500	...Repeated for module number 17					
3501	...Repeated for module number 18					
3502	...Repeated for module number 19					
3503	...Repeated for module number 20					
3504	...Repeated for module number 21					
3505	...Repeated for module number 22					
3506	...Repeated for module number 23					
3507	...Repeated for module number 24					
3508	...Repeated for module number 25					
3509	...Repeated for module number 26					
350A	...Repeated for module number 27					
350B	...Repeated for module number 28					
350C	...Repeated for module number 29					
350D	...Repeated for module number 30					
350E	...Repeated for module number 31					
350F	...Repeated for module number 32					
3510	...Repeated for module number 33					
3511	...Repeated for module number 34					
3512	...Repeated for module number 35					
3513	...Repeated for module number 36					
3514	...Repeated for module number 37					
3515	...Repeated for module number 38					
3516	...Repeated for module number 39					
3517	...Repeated for module number 40					
3518	...Repeated for module number 41					
3519	...Repeated for module number 42					
351A	...Repeated for module number 43					
351B	...Repeated for module number 44					
351C	...Repeated for module number 45					
351D	...Repeated for module number 46					
351E	...Repeated for module number 47					
351F	...Repeated for module number 48					
Expanded Direct Input/Output Status (Read Only)						
3560	Direct Device States, one per register (8 items)	0 to 1	---	1	F155	0 (Offline)
3570	Direct Input States, one per register (96 items)	0 to 1	---	1	F108	0 (Off)
Passwords (Read/Write Command)						
4000	Command Password Setting	0 to 4294967295	---	1	F003	0
Passwords (Read/Write Setting)						
4002	Setting Password Setting	0 to 4294967295	---	1	F003	0
Passwords (Read/Write)						
4008	Command Password Entry	0 to 4294967295	---	1	F003	0
400A	Setting Password Entry	0 to 4294967295	---	1	F003	0
Passwords (Read Only)						
4010	Command Password Status	0 to 1	---	1	F102	0 (Disabled)
4011	Setting Password Status	0 to 1	---	1	F102	0 (Disabled)
User Display Invoke (Read/Write Setting)						
4040	Invoke and Scroll Through User Display Menu Operand	0 to 65535	---	1	F300	0
LED Test (Read/Write Setting)						
4048	LED Test Function	0 to 1	---	1	F102	0 (Disabled)
4049	LED Test Control	0 to 65535	---	1	F300	0
Preferences (Read/Write Setting)						
4050	Flash Message Time	0.5 to 10	s	0.1	F001	10

Table B-9: MODBUS MEMORY MAP (Sheet 10 of 36)

ADDR	REGISTER NAME	RANGE	UNITS	STEP	FORMAT	DEFAULT
4051	Default Message Timeout	10 to 900	s	1	F001	300
4052	Default Message Intensity	0 to 3	---	1	F101	0 (25%)
4053	Screen Saver Feature	0 to 1	---	1	F102	0 (Disabled)
4054	Screen Saver Wait Time	1 to 65535	min	1	F001	30
4055	Current Cutoff Level	0.002 to 0.02	pu	0.001	F001	20
4056	Voltage Cutoff Level	0.1 to 1	V	0.1	F001	10
Communications (Read/Write Setting)						
407E	COM1 minimum response time	0 to 1000	ms	10	F001	0
407F	COM2 minimum response time	0 to 1000	ms	10	F001	0
4080	Modbus Slave Address	1 to 254	---	1	F001	254
4083	RS485 Com1 Baud Rate	0 to 11	---	1	F112	8 (115200)
4084	RS485 Com1 Parity	0 to 2	---	1	F113	0 (None)
4085	RS485 Com2 Baud Rate	0 to 11	---	1	F112	8 (115200)
4086	RS485 Com2 Parity	0 to 2	---	1	F113	0 (None)
4087	IP Address	0 to 4294967295	---	1	F003	56554706
4089	IP Subnet Mask	0 to 4294967295	---	1	F003	4294966272
408B	Gateway IP Address	0 to 4294967295	---	1	F003	56554497
408D	Network Address NSAP	---	---	---	F074	0
4097	Default GSSE Update Time	1 to 60	s	1	F001	60
409A	DNP Port	0 to 4	---	1	F177	0 (NONE)
409B	DNP Address	0 to 65519	---	1	F001	1
409C	DNP Client Addresses (2 items)	0 to 4294967295	---	1	F003	0
40A0	TCP Port Number for the Modbus protocol	1 to 65535	---	1	F001	502
40A1	TCP/UDP Port Number for the DNP Protocol	1 to 65535	---	1	F001	20000
40A2	TCP Port Number for the IEC 61850 Protocol	1 to 65535	---	1	F001	102
40A3	TCP Port Number for the HTTP (Web Server) Protocol	1 to 65535	---	1	F001	80
40A4	Main UDP Port Number for the TFTP Protocol	1 to 65535	---	1	F001	69
40A5	Data Transfer UDP Port Numbers for the TFTP Protocol (zero means "automatic") (2 items)	0 to 65535	---	1	F001	0
40A7	DNP Unsolicited Responses Function	0 to 1	---	1	F102	0 (Disabled)
40A8	DNP Unsolicited Responses Timeout	0 to 60	s	1	F001	5
40A9	DNP Unsolicited Responses Max Retries	1 to 255	---	1	F001	10
40AA	DNP Unsolicited Responses Destination Address	0 to 65519	---	1	F001	1
40AB	Ethernet Operation Mode	0 to 1	---	1	F192	0 (Half-Duplex)
40AC	DNP User Map Function	0 to 1	---	1	F102	0 (Disabled)
40AD	DNP Number of Sources used in Analog points list	1 to 6	---	1	F001	1
40AE	DNP Current Scale Factor	0 to 8	---	1	F194	2 (1)
40AF	DNP Voltage Scale Factor	0 to 8	---	1	F194	2 (1)
40B0	DNP Power Scale Factor	0 to 8	---	1	F194	2 (1)
40B1	DNP Energy Scale Factor	0 to 8	---	1	F194	2 (1)
40B2	DNP Other Scale Factor	0 to 8	---	1	F194	2 (1)
40B3	DNP Current Default Deadband	0 to 65535	---	1	F001	30000
40B4	DNP Voltage Default Deadband	0 to 65535	---	1	F001	30000
40B5	DNP Power Default Deadband	0 to 65535	---	1	F001	30000
40B6	DNP Energy Default Deadband	0 to 65535	---	1	F001	30000
40B7	DNP Other Default Deadband	0 to 65535	---	1	F001	30000
40B8	DNP IIN Time Sync Bit Period	1 to 10080	min	1	F001	1440
40B9	DNP Message Fragment Size	30 to 2048	---	1	F001	240
40BA	DNP Client Address 3	0 to 4294967295	---	1	F003	0
40BC	DNP Client Address 4	0 to 4294967295	---	1	F003	0
40BE	DNP Client Address 5	0 to 4294967295	---	1	F003	0
40C0	DNP Communications Reserved (8 items)	0 to 1	---	1	F001	0
40C8	IEC 61850 Logical Device Name	---	---	---	F203	"IECDevice"
40D0	GSSE Function	0 to 1	---	1	F102	1 (Enabled)

Table B-9: MODBUS MEMORY MAP (Sheet 11 of 36)

ADDR	REGISTER NAME	RANGE	UNITS	STEP	FORMAT	DEFAULT
40D1	Reserved (15 items)	0 to 1	---	1	F001	0
40E0	TCP Port Number for the IEC 60870-5-104 Protocol	1 to 65535	---	1	F001	2404
40E1	IEC 60870-5-104 Protocol Function	0 to 1	---	1	F102	0 (Disabled)
40E2	IEC 60870-5-104 Protocol Common Address of ASDU	0 to 65535	---	1	F001	0
40E3	IEC 60870-5-104 Protocol Cyclic Data Trans. Period	1 to 65535	s	1	F001	60
40E4	IEC 60870-5-104 Sources used in M_ME_NC_1 point list	1 to 6	---	1	F001	1
40E5	IEC 60870-5-104 Current Default Threshold	0 to 65535	---	1	F001	30000
40E6	IEC 60870-5-104 Voltage Default Threshold	0 to 65535	---	1	F001	30000
40E7	IEC 60870-5-104 Power Default Threshold	0 to 65535	---	1	F001	30000
40E8	IEC 60870-5-104 Energy Default Threshold	0 to 65535	---	1	F001	30000
40E9	IEC 60870-5-104 Other Default Threshold	0 to 65535	---	1	F001	30000
40EA	IEC 60870-5-104 Client Address (5 items)	0 to 4294967295	---	1	F003	0
40FE	IEC 60870-5-104 Communications Reserved (2 items)	0 to 1	---	1	F001	0
4100	DNP Binary Input Block of 16 Points (58 items)	0 to 58	---	1	F197	0 (Not Used)
4140	DNP Object 1 Default Variation	1 to 2	---	1	F001	2
4141	DNP Object 2 Default Variation	1 to 2	---	1	F001	2
4142	DNP Object 20 Default Variation	0 to 3	---	1	F523	0 (1)
4143	DNP Object 21 Default Variation	0 to 3	---	1	F524	0 (1)
4144	DNP Object 22 Default Variation	0 to 3	---	1	F523	0 (1)
4145	DNP Object 23 Default Variation	0 to 3	---	1	F523	0 (1)
4146	DNP Object 30 Default Variation	1 to 5	---	1	F001	1
4147	DNP Object 32 Default Variation	0 to 5	---	1	F525	0 (1)
Simple Network Time Protocol (Read/Write Setting)						
4168	Simple Network Time Protocol (SNTP) Function	0 to 1	---	1	F102	0 (Disabled)
4169	Simple Network Time Protocol (SNTP) Server IP Address	0 to 4294967295	---	1	F003	0
416B	Simple Network Time Protocol (SNTP) UDP Port Number	1 to 65535	---	1	F001	123
Data Logger Commands (Read/Write Command)						
4170	Data Logger Clear	0 to 1	---	1	F126	0 (No)
Data Logger (Read/Write Setting)						
4180	Data Logger Rate	0 to 7	---	1	F178	1 (1 min)
4181	Data Logger Channel Settings (16 items)	---	---	---	F600	0
Clock (Read/Write Command)						
41A0	Real Time Clock Set Time	0 to 235959	---	1	F050	0
Clock (Read/Write Setting)						
41A2	SR Date Format	0 to 4294967295	---	1	F051	0
41A4	SR Time Format	0 to 4294967295	---	1	F052	0
41A6	IRIG-B Signal Type	0 to 2	---	1	F114	0 (None)
41A7	Clock Events Enable / Disable	0 to 1	---	1	F102	0 (Disabled)
Fault Report Commands (Read/Write Command)						
41B2	Fault Reports Clear Data Command	0 to 1	---	1	F126	0 (No)
Oscillography (Read/Write Setting)						
41C0	Oscillography Number of Records	1 to 64	---	1	F001	15
41C1	Oscillography Trigger Mode	0 to 1	---	1	F118	0 (Auto. Overwrite)
41C2	Oscillography Trigger Position	0 to 100	%	1	F001	50
41C3	Oscillography Trigger Source	0 to 65535	---	1	F300	0
41C4	Oscillography AC Input Waveforms	0 to 4	---	1	F183	2 (16 samples/cycle)
41D0	Oscillography Analog Channel <i>n</i> (16 items)	0 to 65535	---	1	F600	0
4200	Oscillography Digital Channel <i>n</i> (63 items)	0 to 65535	---	1	F300	0
Trip and Alarm LEDs (Read/Write Setting)						
4260	Trip LED Input FlexLogic Operand	0 to 65535	---	1	F300	0
4261	Alarm LED Input FlexLogic Operand	0 to 65535	---	1	F300	0
User Programmable LEDs (Read/Write Setting) (48 modules)						
4280	FlexLogic Operand to Activate LED	0 to 65535	---	1	F300	0
4281	User LED type (latched or self-resetting)	0 to 1	---	1	F127	1 (Self-Reset)

Table B-9: MODBUS MEMORY MAP (Sheet 12 of 36)

ADDR	REGISTER NAME	RANGE	UNITS	STEP	FORMAT	DEFAULT
4282	...Repeated for module number 2					
4284	...Repeated for module number 3					
4286	...Repeated for module number 4					
4288	...Repeated for module number 5					
428A	...Repeated for module number 6					
428C	...Repeated for module number 7					
428E	...Repeated for module number 8					
4290	...Repeated for module number 9					
4292	...Repeated for module number 10					
4294	...Repeated for module number 11					
4296	...Repeated for module number 12					
4298	...Repeated for module number 13					
429A	...Repeated for module number 14					
429C	...Repeated for module number 15					
429E	...Repeated for module number 16					
42A0	...Repeated for module number 17					
42A2	...Repeated for module number 18					
42A4	...Repeated for module number 19					
42A6	...Repeated for module number 20					
42A8	...Repeated for module number 21					
42AA	...Repeated for module number 22					
42AC	...Repeated for module number 23					
42AE	...Repeated for module number 24					
42B0	...Repeated for module number 25					
42B2	...Repeated for module number 26					
42B4	...Repeated for module number 27					
42B6	...Repeated for module number 28					
42B8	...Repeated for module number 29					
42BA	...Repeated for module number 30					
42BC	...Repeated for module number 31					
42BE	...Repeated for module number 32					
42C0	...Repeated for module number 33					
42C2	...Repeated for module number 34					
42C4	...Repeated for module number 35					
42C6	...Repeated for module number 36					
42C8	...Repeated for module number 37					
42CA	...Repeated for module number 38					
42CC	...Repeated for module number 39					
42CE	...Repeated for module number 40					
42D0	...Repeated for module number 41					
42D2	...Repeated for module number 42					
42D4	...Repeated for module number 43					
42D6	...Repeated for module number 44					
42D8	...Repeated for module number 45					
42DA	...Repeated for module number 46					
42DC	...Repeated for module number 47					
42DE	...Repeated for module number 48					
Installation (Read/Write Setting)						
43E0	Relay Programmed State	0 to 1	---	1	F133	0 (Not Programmed)
43E1	Relay Name	---	---	---	F202	"Relay-1"
User Programmable Self Tests (Read/Write Setting)						
4441	User Programmable Detect Ring Break Function	0 to 1	---	1	F102	1 (Enabled)
4442	User Programmable Direct Device Off Function	0 to 1	---	1	F102	1 (Enabled)
4443	User Programmable Remote Device Off Function	0 to 1	---	1	F102	1 (Enabled)

B

Table B-9: MODBUS MEMORY MAP (Sheet 13 of 36)

ADDR	REGISTER NAME	RANGE	UNITS	STEP	FORMAT	DEFAULT
4444	User Programmable Primary Ethernet Fail Function	0 to 1	---	1	F102	0 (Disabled)
4445	User Programmable Secondary Ethernet Fail Function	0 to 1	---	1	F102	0 (Disabled)
4446	User Programmable Battery Fail Function	0 to 1	---	1	F102	1 (Enabled)
4447	User Programmable SNTP Fail Function	0 to 1	---	1	F102	1 (Enabled)
4448	User Programmable IRIG-B Fail Function	0 to 1	---	1	F102	1 (Enabled)
CT Settings (Read/Write Setting) (6 modules)						
4480	Phase CT Primary	1 to 65000	A	1	F001	1
4481	Phase CT Secondary	0 to 1	---	1	F123	0 (1 A)
4482	Ground CT Primary	1 to 65000	A	1	F001	1
4483	Ground CT Secondary	0 to 1	---	1	F123	0 (1 A)
4484	...Repeated for module number 2					
4488	...Repeated for module number 3					
448C	...Repeated for module number 4					
4490	...Repeated for module number 5					
4494	...Repeated for module number 6					
VT Settings (Read/Write Setting) (3 modules)						
4500	Phase VT Connection	0 to 1	---	1	F100	0 (Wye)
4501	Phase VT Secondary	50 to 240	V	0.1	F001	664
4502	Phase VT Ratio	1 to 24000	:1	1	F060	1
4504	Auxiliary VT Connection	0 to 6	---	1	F166	1 (Vag)
4505	Auxiliary VT Secondary	50 to 240	V	0.1	F001	664
4506	Auxiliary VT Ratio	1 to 24000	:1	1	F060	1
4508	...Repeated for module number 2					
4510	...Repeated for module number 3					
Source Settings (Read/Write Setting) (6 modules)						
4580	Source Name	---	---	---	F206	"SRC 1"
4583	Source Phase CT	0 to 63	---	1	F400	0
4584	Source Ground CT	0 to 63	---	1	F400	0
4585	Source Phase VT	0 to 63	---	1	F400	0
4586	Source Auxiliary VT	0 to 63	---	1	F400	0
4587	...Repeated for module number 2					
458E	...Repeated for module number 3					
4595	...Repeated for module number 4					
459C	...Repeated for module number 5					
45A3	...Repeated for module number 6					
Power System (Read/Write Setting)						
4600	Nominal Frequency	25 to 60	Hz	1	F001	60
4601	Phase Rotation	0 to 1	---	1	F106	0 (ABC)
4602	Frequency And Phase Reference	0 to 5	---	1	F167	0 (SRC 1)
4603	Frequency Tracking Function	0 to 1	---	1	F102	1 (Enabled)
Demand (Read/Write Setting)						
47D0	Demand Current Method	0 to 2	---	1	F139	0 (Thrm. Exponential)
47D1	Demand Power Method	0 to 2	---	1	F139	0 (Thrm. Exponential)
47D2	Demand Interval	0 to 5	---	1	F132	2 (15 MIN)
47D3	Demand Input	0 to 65535	---	1	F300	0
Demand (Read/Write Command)						
47D4	Demand Clear Record	0 to 1	---	1	F126	0 (No)
Flexcurves A and B (Read/Write Settings)						
4800	FlexCurve A (120 items)	0 to 65535	ms	1	F011	0
48F0	FlexCurve B (120 items)	0 to 65535	ms	1	F011	0
Modbus User Map (Read/Write Setting)						
4A00	Modbus Address Settings for User Map (256 items)	0 to 65535	---	1	F001	0
User Displays Settings (Read/Write Setting) (16 modules)						
4C00	User display 1 top line text	---	---	---	F202	" "

Table B-9: MODBUS MEMORY MAP (Sheet 14 of 36)

ADDR	REGISTER NAME	RANGE	UNITS	STEP	FORMAT	DEFAULT
4C0A	User display 1 bottom line text	---	---	---	F202	""
4C14	Modbus addresses of displayed items (5 items)	0 to 65535	---	1	F001	0
4C19	Reserved (7 items)	---	---	---	F001	0
4C20	...Repeated for module number 2					
4C40	...Repeated for module number 3					
4C60	...Repeated for module number 4					
4C80	...Repeated for module number 5					
4CA0	...Repeated for module number 6					
4CC0	...Repeated for module number 7					
4CE0	...Repeated for module number 8					
4D00	...Repeated for module number 9					
4D20	...Repeated for module number 10					
4D40	...Repeated for module number 11					
4D60	...Repeated for module number 12					
4D80	...Repeated for module number 13					
4DA0	...Repeated for module number 14					
4DC0	...Repeated for module number 15					
4DE0	...Repeated for module number 16					
User Programmable Pushbuttons (Read/Write Setting) (12 modules)						
4E00	User Programmable Pushbutton 1 Function	0 to 2	---	1	F109	2 (Disabled)
4E01	User Programmable Pushbutton 1 Top Line	---	---	---	F202	(none)
4E0B	User Programmable Pushbutton 1 On Text	---	---	---	F202	(none)
4E15	User Programmable Pushbutton 1 Off Text	---	---	---	F202	(none)
4E1F	User Programmable Pushbutton 1 Drop-Out Time	0 to 60	s	0.05	F001	0
4E20	User Programmable Pushbutton 1 Target	0 to 2	---	1	F109	0 (Self-reset)
4E21	User Programmable Pushbutton 1 Events	0 to 1	---	1	F102	0 (Disabled)
4E22	User Programmable Pushbutton 1 Reserved (2 items)	0 to 65535	---	1	F001	0
4E24	...Repeated for module number 2					
4E48	...Repeated for module number 3					
4E6C	...Repeated for module number 4					
4E90	...Repeated for module number 5					
4EB4	...Repeated for module number 6					
4ED8	...Repeated for module number 7					
4EFC	...Repeated for module number 8					
4F20	...Repeated for module number 9					
4F44	...Repeated for module number 10					
4F68	...Repeated for module number 11					
4F8C	...Repeated for module number 12					
Flexlogic (Read/Write Setting)						
5000	FlexLogic Entry (512 items)	0 to 65535	---	1	F300	16384
Flexlogic Timers (Read/Write Setting) (32 modules)						
5800	Timer 1 Type	0 to 2	---	1	F129	0 (millisecond)
5801	Timer 1 Pickup Delay	0 to 60000	---	1	F001	0
5802	Timer 1 Dropout Delay	0 to 60000	---	1	F001	0
5803	Timer 1 Reserved (5 items)	0 to 65535	---	1	F001	0
5808	...Repeated for module number 2					
5810	...Repeated for module number 3					
5818	...Repeated for module number 4					
5820	...Repeated for module number 5					
5828	...Repeated for module number 6					
5830	...Repeated for module number 7					
5838	...Repeated for module number 8					
5840	...Repeated for module number 9					
5848	...Repeated for module number 10					

Table B-9: MODBUS MEMORY MAP (Sheet 15 of 36)

ADDR	REGISTER NAME	RANGE	UNITS	STEP	FORMAT	DEFAULT
5850	...Repeated for module number 11					
5858	...Repeated for module number 12					
5860	...Repeated for module number 13					
5868	...Repeated for module number 14					
5870	...Repeated for module number 15					
5878	...Repeated for module number 16					
5880	...Repeated for module number 17					
5888	...Repeated for module number 18					
5890	...Repeated for module number 19					
5898	...Repeated for module number 20					
58A0	...Repeated for module number 21					
58A8	...Repeated for module number 22					
58B0	...Repeated for module number 23					
58B8	...Repeated for module number 24					
58C0	...Repeated for module number 25					
58C8	...Repeated for module number 26					
58D0	...Repeated for module number 27					
58D8	...Repeated for module number 28					
58E0	...Repeated for module number 29					
58E8	...Repeated for module number 30					
58F0	...Repeated for module number 31					
58F8	...Repeated for module number 32					
Phase Time Overcurrent (Read/Write Grouped Setting) (6 modules)						
5900	Phase TOC 1 Function	0 to 1	---	1	F102	0 (Disabled)
5901	Phase TOC 1 Signal Source	0 to 5	---	1	F167	0 (SRC 1)
5902	Phase TOC 1 Input	0 to 1	---	1	F122	0 (Phasor)
5903	Phase TOC 1 Pickup	0 to 30	pu	0.001	F001	1000
5904	Phase TOC 1 Curve	0 to 16	---	1	F103	0 (IEEE Mod Inv)
5905	Phase TOC 1 Multiplier	0 to 600	---	0.01	F001	100
5906	Phase TOC 1 Reset	0 to 1	---	1	F104	0 (Instantaneous)
5907	Phase TOC 1 Voltage Restraint	0 to 1	---	1	F102	0 (Disabled)
5908	Phase TOC 1 Block For Each Phase (3 items)	0 to 65535	---	1	F300	0
590B	Phase TOC 1 Target	0 to 2	---	1	F109	0 (Self-reset)
590C	Phase TOC 1 Events	0 to 1	---	1	F102	0 (Disabled)
590D	Reserved (3 items)	0 to 1	---	1	F001	0
5910	...Repeated for module number 2					
5920	...Repeated for module number 3					
5930	...Repeated for module number 4					
5940	...Repeated for module number 5					
5950	...Repeated for module number 6					
Phase Instantaneous Overcurrent (Read/Write Grouped Setting) (12 modules)						
5A00	Phase IOC1 Function	0 to 1	---	1	F102	0 (Disabled)
5A01	Phase IOC1 Signal Source	0 to 5	---	1	F167	0 (SRC 1)
5A02	Phase IOC1 Pickup	0 to 30	pu	0.001	F001	1000
5A03	Phase IOC1 Delay	0 to 600	s	0.01	F001	0
5A04	Phase IOC1 Reset Delay	0 to 600	s	0.01	F001	0
5A05	Phase IOC1 Block For Each Phase (3 items)	0 to 65535	---	1	F300	0
5A08	Phase IOC1 Target	0 to 2	---	1	F109	0 (Self-reset)
5A09	Phase IOC1 Events	0 to 1	---	1	F102	0 (Disabled)
5A0A	Reserved (6 items)	0 to 1	---	1	F001	0
5A10	...Repeated for module number 2					
5A20	...Repeated for module number 3					
5A30	...Repeated for module number 4					
5A40	...Repeated for module number 5					

B

Table B-9: MODBUS MEMORY MAP (Sheet 16 of 36)

ADDR	REGISTER NAME	RANGE	UNITS	STEP	FORMAT	DEFAULT
5A50	...Repeated for module number 6					
5A60	...Repeated for module number 7					
5A70	...Repeated for module number 8					
5A80	...Repeated for module number 9					
5A90	...Repeated for module number 10					
5AA0	...Repeated for module number 11					
5AB0	...Repeated for module number 12					
Neutral Time Overcurrent (Read/Write Grouped Setting) (6 modules)						
5B00	Neutral TOC1 Function	0 to 1	---	1	F102	0 (Disabled)
5B01	Neutral TOC1 Signal Source	0 to 5	---	1	F167	0 (SRC 1)
5B02	Neutral TOC1 Input	0 to 1	---	1	F122	0 (Phasor)
5B03	Neutral TOC1 Pickup	0 to 30	pu	0.001	F001	1000
5B04	Neutral TOC1 Curve	0 to 16	---	1	F103	0 (IEEE Mod Inv)
5B05	Neutral TOC1 Multiplier	0 to 600	---	0.01	F001	100
5B06	Neutral TOC1 Reset	0 to 1	---	1	F104	0 (Instantaneous)
5B07	Neutral TOC1 Block	0 to 65535	---	1	F300	0
5B08	Neutral TOC1 Target	0 to 2	---	1	F109	0 (Self-reset)
5B09	Neutral TOC1 Events	0 to 1	---	1	F102	0 (Disabled)
5B0A	Reserved (6 items)	0 to 1	---	1	F001	0
5B10	...Repeated for module number 2					
5B20	...Repeated for module number 3					
5B30	...Repeated for module number 4					
5B40	...Repeated for module number 5					
5B50	...Repeated for module number 6					
Neutral Instantaneous Overcurrent (Read/Write Grouped Setting) (12 modules)						
5C00	Neutral IOC1 Function	0 to 1	---	1	F102	0 (Disabled)
5C01	Neutral IOC1 Signal Source	0 to 5	---	1	F167	0 (SRC 1)
5C02	Neutral IOC1 Pickup	0 to 30	pu	0.001	F001	1000
5C03	Neutral IOC1 Delay	0 to 600	s	0.01	F001	0
5C04	Neutral IOC1 Reset Delay	0 to 600	s	0.01	F001	0
5C05	Neutral IOC1 Block	0 to 65535	---	1	F300	0
5C06	Neutral IOC1 Target	0 to 2	---	1	F109	0 (Self-reset)
5C07	Neutral IOC1 Events	0 to 1	---	1	F102	0 (Disabled)
5C08	Reserved (8 items)	0 to 1	---	1	F001	0
5C10	...Repeated for module number 2					
5C20	...Repeated for module number 3					
5C30	...Repeated for module number 4					
5C40	...Repeated for module number 5					
5C50	...Repeated for module number 6					
5C60	...Repeated for module number 7					
5C70	...Repeated for module number 8					
5C80	...Repeated for module number 9					
5C90	...Repeated for module number 10					
5CA0	...Repeated for module number 11					
5CB0	...Repeated for module number 12					
Ground Time Overcurrent (Read/Write Grouped Setting) (6 modules)						
5D00	Ground TOC1 Function	0 to 1	---	1	F102	0 (Disabled)
5D01	Ground TOC1 Signal Source	0 to 5	---	1	F167	0 (SRC 1)
5D02	Ground TOC1 Input	0 to 1	---	1	F122	0 (Phasor)
5D03	Ground TOC1 Pickup	0 to 30	pu	0.001	F001	1000
5D04	Ground TOC1 Curve	0 to 16	---	1	F103	0 (IEEE Mod Inv)
5D05	Ground TOC1 Multiplier	0 to 600	---	0.01	F001	100
5D06	Ground TOC1 Reset	0 to 1	---	1	F104	0 (Instantaneous)
5D07	Ground TOC1 Block	0 to 65535	---	1	F300	0

Table B-9: MODBUS MEMORY MAP (Sheet 17 of 36)

ADDR	REGISTER NAME	RANGE	UNITS	STEP	FORMAT	DEFAULT
5D08	Ground TOC1 Target	0 to 2	---	1	F109	0 (Self-reset)
5D09	Ground TOC1 Events	0 to 1	---	1	F102	0 (Disabled)
5D0A	Reserved (6 items)	0 to 1	---	1	F001	0
5D10	...Repeated for module number 2					
5D20	...Repeated for module number 3					
5D30	...Repeated for module number 4					
5D40	...Repeated for module number 5					
5D50	...Repeated for module number 6					
Ground Instantaneous Overcurrent (Read/Write Grouped Setting) (12 modules)						
5E00	Ground IOC1 Signal Source	0 to 5	---	1	F167	0 (SRC 1)
5E01	Ground IOC1 Function	0 to 1	---	1	F102	0 (Disabled)
5E02	Ground IOC1 Pickup	0 to 30	pu	0.001	F001	1000
5E03	Ground IOC1 Delay	0 to 600	s	0.01	F001	0
5E04	Ground IOC1 Reset Delay	0 to 600	s	0.01	F001	0
5E05	Ground IOC1 Block	0 to 65535	---	1	F300	0
5E06	Ground IOC1 Target	0 to 2	---	1	F109	0 (Self-reset)
5E07	Ground IOC1 Events	0 to 1	---	1	F102	0 (Disabled)
5E08	Reserved (8 items)	0 to 1	---	1	F001	0
5E10	...Repeated for module number 2					
5E20	...Repeated for module number 3					
5E30	...Repeated for module number 4					
5E40	...Repeated for module number 5					
5E50	...Repeated for module number 6					
5E60	...Repeated for module number 7					
5E70	...Repeated for module number 8					
5E80	...Repeated for module number 9					
5E90	...Repeated for module number 10					
5EA0	...Repeated for module number 11					
5EB0	...Repeated for module number 12					
Autoreclose (Read/Write Setting) (6 modules)						
6240	Autoreclose 1 Function	0 to 1	---	1	F102	0 (Disabled)
6241	Autoreclose 1 Initiate	0 to 65535	---	1	F300	0
6242	Autoreclose 1 Block	0 to 65535	---	1	F300	0
6243	Autoreclose 1 Max Number of Shots	1 to 4	---	1	F001	1
6244	Autoreclose 1 Manual Close	0 to 65535	---	1	F300	0
6245	Autoreclose 1 Manual Reset from LO	0 to 65535	---	1	F300	0
6246	Autoreclose 1 Reset Lockout if Breaker Closed	0 to 1	---	1	F108	0 (Off)
6247	Autoreclose 1 Reset Lockout On Manual Close	0 to 1	---	1	F108	0 (Off)
6248	Autoreclose 1 Breaker Closed	0 to 65535	---	1	F300	0
6249	Autoreclose 1 Breaker Open	0 to 65535	---	1	F300	0
624A	Autoreclose 1 Block Time Upon Manual Close	0 to 655.35	s	0.01	F001	1000
624B	Autoreclose 1 Dead Time Shot 1	0 to 655.35	s	0.01	F001	100
624C	Autoreclose 1 Dead Time Shot 2	0 to 655.35	s	0.01	F001	200
624D	Autoreclose 1 Dead Time Shot 3	0 to 655.35	s	0.01	F001	300
624E	Autoreclose 1 Dead Time Shot 4	0 to 655.35	s	0.01	F001	400
624F	Autoreclose 1 Reset Lockout Delay	0 to 655.35	s	0.01	F001	6000
6250	Autoreclose 1 Reset Time	0 to 655.35	s	0.01	F001	6000
6251	Autoreclose 1 Incomplete Sequence Time	0 to 655.35	s	0.01	F001	500
6252	Autoreclose 1 Events	0 to 1	---	1	F102	0 (Disabled)
6253	Autoreclose 1 Reduce Max 1	0 to 65535	---	1	F300	0
6254	Autoreclose 1 Reduce Max 2	0 to 65535	---	1	F300	0
6255	Autoreclose 1 Reduce Max 3	0 to 65535	---	1	F300	0
6256	Autoreclose 1 Add Delay 1	0 to 65535	---	1	F300	0
6257	Autoreclose 1 Delay 1	0 to 655.35	s	0.01	F001	0

Table B-9: MODBUS MEMORY MAP (Sheet 18 of 36)

ADDR	REGISTER NAME	RANGE	UNITS	STEP	FORMAT	DEFAULT
6258	Autoreclose 1 Add Delay 2	0 to 65535	---	1	F300	0
6259	Autoreclose 1 Delay 2	0 to 655.35	s	0.01	F001	0
625A	Autoreclose 1 Reserved (4 items)	0 to 0.001	---	0.001	F001	0
625E	...Repeated for module number 2					
627C	...Repeated for module number 3					
629A	...Repeated for module number 4					
62B8	...Repeated for module number 5					
62D6	...Repeated for module number 6					
Phase Undervoltage (Read/Write Grouped Setting) (2 modules)						
7000	Phase UV1 Function	0 to 1	---	1	F102	0 (Disabled)
7001	Phase UV1 Signal Source	0 to 5	---	1	F167	0 (SRC 1)
7002	Phase UV1 Pickup	0 to 3	pu	0.001	F001	1000
7003	Phase UV1 Curve	0 to 1	---	1	F111	0 (Definite Time)
7004	Phase UV1 Delay	0 to 600	s	0.01	F001	100
7005	Phase UV1 Minimum Voltage	0 to 3	pu	0.001	F001	100
7006	Phase UV1 Block	0 to 65535	---	1	F300	0
7007	Phase UV1 Target	0 to 2	---	1	F109	0 (Self-reset)
7008	Phase UV1 Events	0 to 1	---	1	F102	0 (Disabled)
7009	Phase UV Measurement Mode	0 to 1	---	1	F186	0 (Phase to Ground)
700A	Reserved (6 items)	0 to 1	---	1	F001	0
7013	...Repeated for module number 2					
Breaker Arcing Current Settings (Read/Write Setting) (2 modules)						
72C0	Breaker 1 Arcing Current Function	0 to 1	---	1	F102	0 (Disabled)
72C1	Breaker 1 Arcing Current Source	0 to 5	---	1	F167	0 (SRC 1)
72C2	Breaker 1 Arcing Current Initiate A	0 to 65535	---	1	F300	0
72C3	Breaker 1 Arcing Current Initiate B	0 to 65535	---	1	F300	0
72C4	Breaker 1 Arcing Current Initiate C	0 to 65535	---	1	F300	0
72C5	Breaker 1 Arcing Current Delay	0 to 65.535	s	0.001	F001	0
72C6	Breaker 1 Arcing Current Limit	0 to 50000	kA ² -cyc	1	F001	1000
72C7	Breaker 1 Arcing Current Block	0 to 65535	---	1	F300	0
72C8	Breaker 1 Arcing Current Target	0 to 2	---	1	F109	0 (Self-reset)
72C9	Breaker 1 Arcing Current Events	0 to 1	---	1	F102	0 (Disabled)
72CA	...Repeated for module number 2					
72D4	...Repeated for module number 3					
72DE	...Repeated for module number 4					
72E8	...Repeated for module number 5					
72F2	...Repeated for module number 6					
DCMA Inputs (Read/Write Setting) (24 modules)						
7300	DCMA Inputs 1 Function	0 to 1	---	1	F102	0 (Disabled)
7301	DCMA Inputs 1 ID	---	---	---	F205	"DCMA I 1"
7307	DCMA Inputs 1 Reserved 1 (4 items)	0 to 65535	---	1	F001	0
730B	DCMA Inputs 1 Units	---	---	---	F206	"mA"
730E	DCMA Inputs 1 Range	0 to 6	---	1	F173	6 (4 to 20 mA)
730F	DCMA Inputs 1 Minimum Value	-9999.999 to 9999.999	---	0.001	F004	4000
7311	DCMA Inputs 1 Maximum Value	-9999.999 to 9999.999	---	0.001	F004	20000
7313	DCMA Inputs 1 Reserved (5 items)	0 to 65535	---	1	F001	0
7318	...Repeated for module number 2					
7330	...Repeated for module number 3					
7348	...Repeated for module number 4					
7360	...Repeated for module number 5					
7378	...Repeated for module number 6					
7390	...Repeated for module number 7					
73A8	...Repeated for module number 8					
73C0	...Repeated for module number 9					

Table B-9: MODBUS MEMORY MAP (Sheet 19 of 36)

ADDR	REGISTER NAME	RANGE	UNITS	STEP	FORMAT	DEFAULT
73D8	...Repeated for module number 10					
73F0	...Repeated for module number 11					
7408	...Repeated for module number 12					
7420	...Repeated for module number 13					
7438	...Repeated for module number 14					
7450	...Repeated for module number 15					
7468	...Repeated for module number 16					
7480	...Repeated for module number 17					
7498	...Repeated for module number 18					
74B0	...Repeated for module number 19					
74C8	...Repeated for module number 20					
74E0	...Repeated for module number 21					
74F8	...Repeated for module number 22					
7510	...Repeated for module number 23					
7528	...Repeated for module number 24					
RTD Inputs (Read/Write Setting) (48 modules)						
7540	RTD Inputs 1 Function	0 to 1	---	1	F102	0 (Disabled)
7541	RTD Inputs 1 ID	---	---	---	F205	"RTD Ip 1"
7547	RTD Inputs 1 Reserved 1 (4 items)	0 to 65535	---	1	F001	0
754B	RTD Inputs 1 Type	0 to 3	---	1	F174	0 (100 Ohm Platinum)
754C	RTD Inputs 1 Reserved 2 (4 items)	0 to 65535	---	1	F001	0
7550	...Repeated for module number 2					
7560	...Repeated for module number 3					
7570	...Repeated for module number 4					
7580	...Repeated for module number 5					
7590	...Repeated for module number 6					
75A0	...Repeated for module number 7					
75B0	...Repeated for module number 8					
75C0	...Repeated for module number 9					
75D0	...Repeated for module number 10					
75E0	...Repeated for module number 11					
75F0	...Repeated for module number 12					
7600	...Repeated for module number 13					
7610	...Repeated for module number 14					
7620	...Repeated for module number 15					
7630	...Repeated for module number 16					
7640	...Repeated for module number 17					
7650	...Repeated for module number 18					
7660	...Repeated for module number 19					
7670	...Repeated for module number 20					
7680	...Repeated for module number 21					
7690	...Repeated for module number 22					
76A0	...Repeated for module number 23					
76B0	...Repeated for module number 24					
76C0	...Repeated for module number 25					
76D0	...Repeated for module number 26					
76E0	...Repeated for module number 27					
76F0	...Repeated for module number 28					
7700	...Repeated for module number 29					
7710	...Repeated for module number 30					
7720	...Repeated for module number 31					
7730	...Repeated for module number 32					
7740	...Repeated for module number 33					
7750	...Repeated for module number 34					

B

Table B-9: MODBUS MEMORY MAP (Sheet 20 of 36)

ADDR	REGISTER NAME	RANGE	UNITS	STEP	FORMAT	DEFAULT
7760	...Repeated for module number 35					
7770	...Repeated for module number 36					
7780	...Repeated for module number 37					
7790	...Repeated for module number 38					
77A0	...Repeated for module number 39					
77B0	...Repeated for module number 40					
77C0	...Repeated for module number 41					
77D0	...Repeated for module number 42					
77E0	...Repeated for module number 43					
77F0	...Repeated for module number 44					
7800	...Repeated for module number 45					
7810	...Repeated for module number 46					
7820	...Repeated for module number 47					
7830	...Repeated for module number 48					
Underfrequency (Read/Write Setting) (6 modules)						
7E00	Underfrequency Function	0 to 1	---	1	F102	0 (Disabled)
7E01	Underfrequency 1 Block	0 to 65535	---	1	F300	0
7E02	Underfrequency 1 Minimum Current	0.1 to 1.25	pu	0.01	F001	10
7E03	Underfrequency 1 Pickup	20 to 65	Hz	0.01	F001	5950
7E04	Underfrequency 1 Pickup Delay	0 to 65.535	s	0.001	F001	2000
7E05	Underfrequency 1 Reset Delay	0 to 65.535	s	0.001	F001	2000
7E06	Underfrequency 1 Source	0 to 5	---	1	F167	0 (SRC 1)
7E07	Underfrequency 1 Events	0 to 1	---	1	F102	0 (Disabled)
7E08	Underfrequency 1 Target	0 to 2	---	1	F109	0 (Self-reset)
7E09	Underfrequency 1 Reserved (8 items)	0 to 1	---	1	F001	0
7E11	...Repeated for module number 2					
7E22	...Repeated for module number 3					
7E33	...Repeated for module number 4					
7E44	...Repeated for module number 5					
7E55	...Repeated for module number 6					
Neutral Overvoltage (Read/Write Grouped Setting) (3 modules)						
7F00	Neutral Overvoltage 1 Function	0 to 1	---	1	F102	0 (Disabled)
7F01	Neutral Overvoltage 1 Signal Source	0 to 5	---	1	F167	0 (SRC 1)
7F02	Neutral Overvoltage 1 Pickup	0 to 1.25	pu	0.001	F001	300
7F03	Neutral Overvoltage 1 Pickup Delay	0 to 600	s	0.01	F001	100
7F04	Neutral Overvoltage 1 Reset Delay	0 to 600	s	0.01	F001	100
7F05	Neutral Overvoltage 1 Block	0 to 65535	---	1	F300	0
7F06	Neutral Overvoltage 1 Target	0 to 2	---	1	F109	0 (Self-reset)
7F07	Neutral Overvoltage 1 Events	0 to 1	---	1	F102	0 (Disabled)
7F08	Neutral Overvoltage 1 Reserved (8 items)	0 to 65535	---	1	F001	0
7F10	...Repeated for module number 2					
7F20	...Repeated for module number 3					
Auxiliary Overvoltage (Read/Write Grouped Setting) (3 modules)						
7F30	Auxiliary Overvoltage 1 Function	0 to 1	---	1	F102	0 (Disabled)
7F31	Auxiliary Overvoltage 1 Signal Source	0 to 5	---	1	F167	0 (SRC 1)
7F32	Auxiliary Overvoltage 1 Pickup	0 to 3	pu	0.001	F001	300
7F33	Auxiliary Overvoltage 1 Pickup Delay	0 to 600	s	0.01	F001	100
7F34	Auxiliary Overvoltage 1 Reset Delay	0 to 600	s	0.01	F001	100
7F35	Auxiliary Overvoltage 1 Block	0 to 65535	---	1	F300	0
7F36	Auxiliary Overvoltage 1 Target	0 to 2	---	1	F109	0 (Self-reset)
7F37	Auxiliary Overvoltage 1 Events	0 to 1	---	1	F102	0 (Disabled)
7F38	Auxiliary Overvoltage 1 Reserved (8 items)	0 to 65535	---	1	F001	0
7F40	...Repeated for module number 2					
7F50	...Repeated for module number 3					

Table B-9: MODBUS MEMORY MAP (Sheet 21 of 36)

ADDR	REGISTER NAME	RANGE	UNITS	STEP	FORMAT	DEFAULT
Auxiliary Undervoltage (Read/Write Grouped Setting) (3 modules)						
7F60	Auxiliary Undervoltage 1 Function	0 to 1	---	1	F102	0 (Disabled)
7F61	Auxiliary Undervoltage 1 Signal Source	0 to 5	---	1	F167	0 (SRC 1)
7F62	Auxiliary Undervoltage 1 Pickup	0 to 3	pu	0.001	F001	700
7F63	Auxiliary Undervoltage 1 Delay	0 to 600	s	0.01	F001	100
7F64	Auxiliary Undervoltage 1 Curve	0 to 1	---	1	F111	0 (Definite Time)
7F65	Auxiliary Undervoltage 1 Minimum Voltage	0 to 3	pu	0.001	F001	100
7F66	Auxiliary Undervoltage 1 Block	0 to 65535	---	1	F300	0
7F67	Auxiliary Undervoltage 1 Target	0 to 2	---	1	F109	0 (Self-reset)
7F68	Auxiliary Undervoltage 1 Events	0 to 1	---	1	F102	0 (Disabled)
7F69	Auxiliary Undervoltage 1 Reserved (7 items)	0 to 65535	---	1	F001	0
7F70	...Repeated for module number 2					
7F80	...Repeated for module number 3					
Frequency (Read Only)						
8000	Tracking Frequency	2 to 90	Hz	0.01	F001	0
Switch (Read/Write Setting) (6 modules)						
8300	Switch 1 Function	0 to 1	---	1	F102	0 (Disabled)
8301	Switch 1 Argument A Bits (8 items)	0 to 65535	---	1	F300	0
8309	Switch 1 Argument B Bits (8 items)	0 to 65535	---	1	F300	0
8311	Switch 1 Control	0 to 65535	---	1	F300	0
8312	Switch 1 Reserved (6 items)	0 to 65535	---	1	F001	0
8318	...Repeated for module number 2					
8330	...Repeated for module number 3					
8348	...Repeated for module number 4					
8360	...Repeated for module number 5					
8378	...Repeated for module number 6					
EGD Fast Production Status (Read Only)						
83E0	EGD Fast Producer Exchange 1 Signature	0 to 65535	---	1	F001	0
83E1	EGD Fast Producer Exchange 1 Configuration Time	0 to 4294967295	---	---	F003	0
83E3	EGD Fast Producer Exchange 1 Size	0 to 65535	---	1	F001	0
EGD Slow Production Status (Read Only) (2 modules)						
83F0	EGD Slow Producer Exchange 1 Signature	0 to 65535	---	1	F001	0
83F1	EGD Slow Producer Exchange 1 Configuration Time	0 to 4294967295	---	---	F003	0
83F3	EGD Slow Producer Exchange 1 Size	0 to 65535	---	1	F001	0
83F4	...Repeated for module number 2					
EGD Fast Production (Read/Write Setting)						
8400	EGD Fast Producer Exchange 1 Function	0 to 1	---	1	F102	0 (Disabled)
8401	EGD Fast Producer Exchange 1 Destination	0 to 4294967295	---	1	F003	0
8403	EGD Fast Producer Exchange 1 Data Rate	50 to 1000	ms	50	F001	1000
8404	EGD Fast Producer Exchange 1 Data Item 1 (20 items)	0 to 65535	---	1	F001	0
8418	Reserved (80 items)	---	---	---	F001	0
EGD Slow Production (Read/Write Setting) (2 modules)						
8500	EGD Slow Producer Exchange 1 Function	0 to 1	---	1	F102	0 (Disabled)
8501	EGD Fast Producer Exchange 1 Destination	0 to 4294967295	---	1	F003	0
8503	EGD Slow Producer Exchange 1 Data Rate	500 to 1000	ms	50	F001	1000
8504	EGD Slow Producer Exchange 1 Data Item 1 (50 items)	0 to 65535	---	1	F001	0
8536	Reserved (50 items)	---	---	---	F001	0
8568	...Repeated for module number 2					
FlexState Settings (Read/Write Setting)						
8800	FlexState Parameters (256 items)	---	---	---	F300	0
FlexElement (Read/Write Setting) (16 modules)						
9000	FlexElement 1 Function	0 to 1	---	1	F102	0 (Disabled)
9001	FlexElement 1 Name	---	---	---	F206	"Fx E 1 "
9004	FlexElement 1 InputP	0 to 65535	---	1	F600	0

Table B-9: MODBUS MEMORY MAP (Sheet 22 of 36)

ADDR	REGISTER NAME	RANGE	UNITS	STEP	FORMAT	DEFAULT
9005	FlexElement 1 InputM	0 to 65535	---	1	F600	0
9006	FlexElement 1 Compare	0 to 1	---	1	F516	0 (LEVEL)
9007	FlexElement 1 Input	0 to 1	---	1	F515	0 (SIGNED)
9008	FlexElement 1 Direction	0 to 1	---	1	F517	0 (OVER)
9009	FlexElement 1 Hysteresis	0.1 to 50	%	0.1	F001	30
900A	FlexElement 1 Pickup	-90 to 90	pu	0.001	F004	1000
900C	FlexElement 1 DeltaT Units	0 to 2	---	1	F518	0 (Milliseconds)
900D	FlexElement 1 DeltaT	20 to 86400	---	1	F003	20
900F	FlexElement 1 Pickup Delay	0 to 65.535	s	0.001	F001	0
9010	FlexElement 1 Reset Delay	0 to 65.535	s	0.001	F001	0
9011	FlexElement 1 Block	0 to 65535	---	1	F300	0
9012	FlexElement 1 Target	0 to 2	---	1	F109	0 (Self-reset)
9013	FlexElement 1 Events	0 to 1	---	1	F102	0 (Disabled)
9014	...Repeated for module number 2					
9028	...Repeated for module number 3					
903C	...Repeated for module number 4					
9050	...Repeated for module number 5					
9064	...Repeated for module number 6					
9078	...Repeated for module number 7					
908C	...Repeated for module number 8					
90A0	...Repeated for module number 9					
90B4	...Repeated for module number 10					
90C8	...Repeated for module number 11					
90DC	...Repeated for module number 12					
90F0	...Repeated for module number 13					
9104	...Repeated for module number 14					
9118	...Repeated for module number 15					
912C	...Repeated for module number 16					
Fault Report Settings (Read/Write Setting) (5 modules)						
9200	Fault Report 1 Source	0 to 5	---	1	F167	0 (SRC 1)
9201	Fault Report 1 Trigger	0 to 65535	---	1	F300	0
9202	Fault Report 1 Z1 Magnitude	0.01 to 250	ohms	0.01	F001	300
9203	Fault Report 1 Z1 Angle	25 to 90	degrees	1	F001	75
9204	Fault Report 1 Z0 Magnitude	0.01 to 650	ohms	0.01	F001	900
9205	Fault Report 1 Z0 Angle	25 to 90	degrees	1	F001	75
9206	Fault Report 1 Line Length Units	0 to 1	---	1	F147	0 (km)
9207	Fault Report 1 Line Length	0 to 2000		0.1	F001	1000
9208	...Repeated for module number 2					
9210	...Repeated for module number 3					
9218	...Repeated for module number 4					
9220	...Repeated for module number 5					
DCMA Outputs (Read/Write Setting) (24 modules)						
9300	DCMA Outputs 1 Source	0 to 65535	---	1	F600	0
9301	DCMA Outputs 1 Range	0 to 2	---	1	F522	0 (-1 to 1 mA)
9302	DCMA Output 1 Minimum	-90 to 90	pu	0.001	F004	0
9304	DCMA Outputs 1 Maximum	-90 to 90	pu	0.001	F004	1000
9306	...Repeated for module number 2					
930C	...Repeated for module number 3					
9312	...Repeated for module number 4					
9318	...Repeated for module number 5					
931E	...Repeated for module number 6					
9324	...Repeated for module number 7					
932A	...Repeated for module number 8					
9330	...Repeated for module number 9					

B

Table B-9: MODBUS MEMORY MAP (Sheet 23 of 36)

ADDR	REGISTER NAME	RANGE	UNITS	STEP	FORMAT	DEFAULT
9336	...Repeated for module number 10					
933C	...Repeated for module number 11					
9342	...Repeated for module number 12					
9348	...Repeated for module number 13					
934E	...Repeated for module number 14					
9354	...Repeated for module number 15					
935A	...Repeated for module number 16					
9360	...Repeated for module number 17					
9366	...Repeated for module number 18					
936C	...Repeated for module number 19					
9372	...Repeated for module number 20					
9378	...Repeated for module number 21					
937E	...Repeated for module number 22					
9384	...Repeated for module number 23					
938A	...Repeated for module number 24					
FlexElement Actuals (Read Only) (16 modules)						
9A01	FlexElement Actual	-2147483.647 to 2147483.647	---	0.001	F004	0
9A03	...Repeated for module number 2					
9A05	...Repeated for module number 3					
9A07	...Repeated for module number 4					
9A09	...Repeated for module number 5					
9A0B	...Repeated for module number 6					
9A0D	...Repeated for module number 7					
9A0F	...Repeated for module number 8					
9A11	...Repeated for module number 9					
9A13	...Repeated for module number 10					
9A15	...Repeated for module number 11					
9A17	...Repeated for module number 12					
9A19	...Repeated for module number 13					
9A1B	...Repeated for module number 14					
9A1D	...Repeated for module number 15					
9A1F	...Repeated for module number 16					
Setting Groups (Read/Write Setting)						
A000	Setting Group for Modbus Comms (0 means group 1)	0 to 5	---	1	F001	0
A001	Setting Groups Block	0 to 65535	---	1	F300	0
A002	FlexLogic to Activate Groups 2 through 8 (5 items)	0 to 65535	---	1	F300	0
A009	Setting Group Function	0 to 1	---	1	F102	0 (Disabled)
A00A	Setting Group Events	0 to 1	---	1	F102	0 (Disabled)
Setting Groups (Read Only)						
A00B	Current Setting Group	0 to 5	---	1	F001	0
Selector Switch Actuals (Read Only)						
A400	Selector 1 Position	1 to 7	---	1	F001	0
A401	Selector 2 Position	1 to 7	---	1	F001	1
Selector Switch (Read/Write Setting) (2 modules)						
A410	Selector 1 Function	0 to 1	---	1	F102	0 (Disabled)
A411	Selector 1 Range	1 to 7	---	1	F001	7
A412	Selector 1 Timeout	3 to 60	s	0.1	F001	50
A413	Selector 1 Step Up	0 to 65535	---	1	F300	0
A414	Selector 1 Step Mode	0 to 1	---	1	F083	0 (Time-out)
A415	Selector 1 Acknowledge	0 to 65535	---	1	F300	0
A416	Selector 1 Bit0	0 to 65535	---	1	F300	0
A417	Selector 1 Bit1	0 to 65535	---	1	F300	0
A418	Selector 1 Bit2	0 to 65535	---	1	F300	0

Table B-9: MODBUS MEMORY MAP (Sheet 24 of 36)

ADDR	REGISTER NAME	RANGE	UNITS	STEP	FORMAT	DEFAULT
A419	Selector 1 Bit Mode	0 to 1	---	1	F083	0 (Time-out)
A41A	Selector 1 Bit Acknowledge	0 to 65535	---	1	F300	0
A41B	Selector 1 Power Up Mode	0 to 2	---	1	F084	0 (Restore)
A41C	Selector 1 Target	0 to 2	---	1	F109	0 (Self-reset)
A41D	Selector 1 Events	0 to 1	---	1	F102	0 (Disabled)
A41E	Selector 1 Reserved (10 items)	---	---	1	F001	0
A428	...Repeated for module number 2					
Flexcurves C and D (Read/Write Setting)						
AC00	FlexCurve C (120 items)	0 to 65535	ms	1	F011	0
AC78	FlexCurve D (120 items)	0 to 65535	ms	1	F011	0
Non Volatile Latches (Read/Write Setting) (16 modules)						
AD00	Latch 1 Function	0 to 1	---	1	F102	0 (Disabled)
AD01	Latch 1 Type	0 to 1	---	1	F519	0 (Reset Dominant)
AD02	Latch 1 Set	0 to 65535	---	1	F300	0
AD03	Latch 1 Reset	0 to 65535	---	1	F300	0
AD04	Latch 1 Target	0 to 2	---	1	F109	0 (Self-reset)
AD05	Latch 1 Events	0 to 1	---	1	F102	0 (Disabled)
AD06	Latch 1 Reserved (4 items)	---	---	---	F001	0
AD0A	...Repeated for module number 2					
AD14	...Repeated for module number 3					
AD1E	...Repeated for module number 4					
AD28	...Repeated for module number 5					
AD32	...Repeated for module number 6					
AD3C	...Repeated for module number 7					
AD46	...Repeated for module number 8					
AD50	...Repeated for module number 9					
AD5A	...Repeated for module number 10					
AD64	...Repeated for module number 11					
AD6E	...Repeated for module number 12					
AD78	...Repeated for module number 13					
AD82	...Repeated for module number 14					
AD8C	...Repeated for module number 15					
AD96	...Repeated for module number 16					
Digital Elements (Read/Write Setting) (16 modules)						
B000	Digital Element 1 Function	0 to 1	---	1	F102	0 (Disabled)
B001	Digital Element 1 Name	---	---	---	F203	"Dig Element 1 "
B015	Digital Element 1 Input	0 to 65535	---	1	F300	0
B016	Digital Element 1 Pickup Delay	0 to 999999.999	s	0.001	F003	0
B018	Digital Element 1 Reset Delay	0 to 999999.999	s	0.001	F003	0
B01A	Digital Element 1 Block	0 to 65535	---	1	F300	0
B01B	Digital Element 1 Target	0 to 2	---	1	F109	0 (Self-reset)
B01C	Digital Element 1 Events	0 to 1	---	1	F102	0 (Disabled)
B01D	Digital Element 1 Reserved (3 items)	---	---	---	F001	0
B020	...Repeated for module number 2					
B040	...Repeated for module number 3					
B060	...Repeated for module number 4					
B080	...Repeated for module number 5					
B0A0	...Repeated for module number 6					
B0C0	...Repeated for module number 7					
B0E0	...Repeated for module number 8					
B100	...Repeated for module number 9					
B120	...Repeated for module number 10					
B140	...Repeated for module number 11					
B160	...Repeated for module number 12					

Table B-9: MODBUS MEMORY MAP (Sheet 25 of 36)

ADDR	REGISTER NAME	RANGE	UNITS	STEP	FORMAT	DEFAULT
B180	...Repeated for module number 13					
B1A0	...Repeated for module number 14					
B1C0	...Repeated for module number 15					
B1E0	...Repeated for module number 16					
Digital Counter (Read/Write Setting) (8 modules)						
B300	Digital Counter 1 Function	0 to 1	---	1	F102	0 (Disabled)
B301	Digital Counter 1 Name	---	---	---	F205	"Counter 1"
B307	Digital Counter 1 Units	---	---	---	F206	(none)
B30A	Digital Counter 1 Block	0 to 65535	---	1	F300	0
B30B	Digital Counter 1 Up	0 to 65535	---	1	F300	0
B30C	Digital Counter 1 Down	0 to 65535	---	1	F300	0
B30D	Digital Counter 1 Preset	-2147483647 to 2147483647	---	1	F004	0
B30F	Digital Counter 1 Compare	-2147483647 to 2147483647	---	1	F004	0
B311	Digital Counter 1 Reset	0 to 65535	---	1	F300	0
B312	Digital Counter 1 Freeze/Reset	0 to 65535	---	1	F300	0
B313	Digital Counter 1 Freeze/Count	0 to 65535	---	1	F300	0
B314	Digital Counter 1 Set To Preset	0 to 65535	---	1	F300	0
B315	Digital Counter 1 Reserved (11 items)	---	---	---	F001	0
B320	...Repeated for module number 2					
B340	...Repeated for module number 3					
B360	...Repeated for module number 4					
B380	...Repeated for module number 5					
B3A0	...Repeated for module number 6					
B3C0	...Repeated for module number 7					
B3E0	...Repeated for module number 8					
Contact Inputs (Read/Write Setting) (96 modules)						
C000	Contact Input 1 Name	---	---	---	F205	"Cont Ip 1"
C006	Contact Input 1 Events	0 to 1	---	1	F102	0 (Disabled)
C007	Contact Input 1 Debounce Time	0 to 16	ms	0.5	F001	20
C008	...Repeated for module number 2					
C010	...Repeated for module number 3					
C018	...Repeated for module number 4					
C020	...Repeated for module number 5					
C028	...Repeated for module number 6					
C030	...Repeated for module number 7					
C038	...Repeated for module number 8					
C040	...Repeated for module number 9					
C048	...Repeated for module number 10					
C050	...Repeated for module number 11					
C058	...Repeated for module number 12					
C060	...Repeated for module number 13					
C068	...Repeated for module number 14					
C070	...Repeated for module number 15					
C078	...Repeated for module number 16					
C080	...Repeated for module number 17					
C088	...Repeated for module number 18					
C090	...Repeated for module number 19					
C098	...Repeated for module number 20					
C0A0	...Repeated for module number 21					
C0A8	...Repeated for module number 22					
C0B0	...Repeated for module number 23					
C0B8	...Repeated for module number 24					
C0C0	...Repeated for module number 25					

B

Table B-9: MODBUS MEMORY MAP (Sheet 26 of 36)

ADDR	REGISTER NAME	RANGE	UNITS	STEP	FORMAT	DEFAULT
C0C8	...Repeated for module number 26					
C0D0	...Repeated for module number 27					
C0D8	...Repeated for module number 28					
C0E0	...Repeated for module number 29					
C0E8	...Repeated for module number 30					
C0F0	...Repeated for module number 31					
C0F8	...Repeated for module number 32					
C100	...Repeated for module number 33					
C108	...Repeated for module number 34					
C110	...Repeated for module number 35					
C118	...Repeated for module number 36					
C120	...Repeated for module number 37					
C128	...Repeated for module number 38					
C130	...Repeated for module number 39					
C138	...Repeated for module number 40					
C140	...Repeated for module number 41					
C148	...Repeated for module number 42					
C150	...Repeated for module number 43					
C158	...Repeated for module number 44					
C160	...Repeated for module number 45					
C168	...Repeated for module number 46					
C170	...Repeated for module number 47					
C178	...Repeated for module number 48					
C180	...Repeated for module number 49					
C188	...Repeated for module number 50					
C190	...Repeated for module number 51					
C198	...Repeated for module number 52					
C1A0	...Repeated for module number 53					
C1A8	...Repeated for module number 54					
C1B0	...Repeated for module number 55					
C1B8	...Repeated for module number 56					
C1C0	...Repeated for module number 57					
C1C8	...Repeated for module number 58					
C1D0	...Repeated for module number 59					
C1D8	...Repeated for module number 60					
C1E0	...Repeated for module number 61					
C1E8	...Repeated for module number 62					
C1F0	...Repeated for module number 63					
C1F8	...Repeated for module number 64					
C200	...Repeated for module number 65					
C208	...Repeated for module number 66					
C210	...Repeated for module number 67					
C218	...Repeated for module number 68					
C220	...Repeated for module number 69					
C228	...Repeated for module number 70					
C230	...Repeated for module number 71					
C238	...Repeated for module number 72					
C240	...Repeated for module number 73					
C248	...Repeated for module number 74					
C250	...Repeated for module number 75					
C258	...Repeated for module number 76					
C260	...Repeated for module number 77					
C268	...Repeated for module number 78					
C270	...Repeated for module number 79					

B

Table B-9: MODBUS MEMORY MAP (Sheet 27 of 36)

ADDR	REGISTER NAME	RANGE	UNITS	STEP	FORMAT	DEFAULT
C278	...Repeated for module number 80					
C280	...Repeated for module number 81					
C288	...Repeated for module number 82					
C290	...Repeated for module number 83					
C298	...Repeated for module number 84					
C2A0	...Repeated for module number 85					
C2A8	...Repeated for module number 86					
C2B0	...Repeated for module number 87					
C2B8	...Repeated for module number 88					
C2C0	...Repeated for module number 89					
C2C8	...Repeated for module number 90					
C2D0	...Repeated for module number 91					
C2D8	...Repeated for module number 92					
C2E0	...Repeated for module number 93					
C2E8	...Repeated for module number 94					
C2F0	...Repeated for module number 95					
C2F8	...Repeated for module number 96					
Contact Input Thresholds (Read/Write Setting)						
C600	Contact Input x Threshold (24 items)	0 to 3	---	1	F128	1 (33 Vdc)
Virtual Inputs Global Settings (Read/Write Setting)						
C680	Virtual Inputs SBO Timeout	1 to 60	s	1	F001	30
Virtual Inputs (Read/Write Setting) (32 modules)						
C690	Virtual Input 1 Function	0 to 1	---	1	F102	0 (Disabled)
C691	Virtual Input 1 Name	---	---	---	F205	"Virt Ip 1 "
C69B	Virtual Input 1 Programmed Type	0 to 1	---	1	F127	0 (Latched)
C69C	Virtual Input 1 Events	0 to 1	---	1	F102	0 (Disabled)
C69D	Virtual Input 1 IEC 61850 SBOClass	1 to 2	---	1	F001	1
C69E	Virtual Input 1 IEC 61850 SBOEna	0 to 1	---	1	F102	0 (Disabled)
C69F	Virtual Input 1 Reserved	---	---	---	F001	0
C6A0	...Repeated for module number 2					
C6B0	...Repeated for module number 3					
C6C0	...Repeated for module number 4					
C6D0	...Repeated for module number 5					
C6E0	...Repeated for module number 6					
C6F0	...Repeated for module number 7					
C700	...Repeated for module number 8					
C710	...Repeated for module number 9					
C720	...Repeated for module number 10					
C730	...Repeated for module number 11					
C740	...Repeated for module number 12					
C750	...Repeated for module number 13					
C760	...Repeated for module number 14					
C770	...Repeated for module number 15					
C780	...Repeated for module number 16					
C790	...Repeated for module number 17					
C7A0	...Repeated for module number 18					
C7B0	...Repeated for module number 19					
C7C0	...Repeated for module number 20					
C7D0	...Repeated for module number 21					
C7E0	...Repeated for module number 22					
C7F0	...Repeated for module number 23					
C800	...Repeated for module number 24					
C810	...Repeated for module number 25					
C820	...Repeated for module number 26					

B

Table B-9: MODBUS MEMORY MAP (Sheet 28 of 36)

ADDR	REGISTER NAME	RANGE	UNITS	STEP	FORMAT	DEFAULT
C830	...Repeated for module number 27					
C840	...Repeated for module number 28					
C850	...Repeated for module number 29					
C860	...Repeated for module number 30					
C870	...Repeated for module number 31					
C880	...Repeated for module number 32					
Virtual Outputs (Read/Write Setting) (64 modules)						
CC90	Virtual Output 1 Name	---	---	---	F205	"Virt Op 1 "
CC9A	Virtual Output 1 Events	0 to 1	---	1	F102	0 (Disabled)
CC9B	Virtual Output 1 Reserved (5 items)	---	---	---	F001	0
CCA0	...Repeated for module number 2					
CCB0	...Repeated for module number 3					
CCC0	...Repeated for module number 4					
CCD0	...Repeated for module number 5					
CCE0	...Repeated for module number 6					
CCF0	...Repeated for module number 7					
CD00	...Repeated for module number 8					
CD10	...Repeated for module number 9					
CD20	...Repeated for module number 10					
CD30	...Repeated for module number 11					
CD40	...Repeated for module number 12					
CD50	...Repeated for module number 13					
CD60	...Repeated for module number 14					
CD70	...Repeated for module number 15					
CD80	...Repeated for module number 16					
CD90	...Repeated for module number 17					
CDA0	...Repeated for module number 18					
CDB0	...Repeated for module number 19					
CDC0	...Repeated for module number 20					
CDD0	...Repeated for module number 21					
CDE0	...Repeated for module number 22					
CDF0	...Repeated for module number 23					
CE00	...Repeated for module number 24					
CE10	...Repeated for module number 25					
CE20	...Repeated for module number 26					
CE30	...Repeated for module number 27					
CE40	...Repeated for module number 28					
CE50	...Repeated for module number 29					
CE60	...Repeated for module number 30					
CE70	...Repeated for module number 31					
CE80	...Repeated for module number 32					
CE90	...Repeated for module number 33					
CEA0	...Repeated for module number 34					
CEB0	...Repeated for module number 35					
CEC0	...Repeated for module number 36					
CED0	...Repeated for module number 37					
CEE0	...Repeated for module number 38					
CEF0	...Repeated for module number 39					
CF00	...Repeated for module number 40					
CF10	...Repeated for module number 41					
CF20	...Repeated for module number 42					
CF30	...Repeated for module number 43					
CF40	...Repeated for module number 44					
CF50	...Repeated for module number 45					

B

Table B-9: MODBUS MEMORY MAP (Sheet 29 of 36)

ADDR	REGISTER NAME	RANGE	UNITS	STEP	FORMAT	DEFAULT
CF60	...Repeated for module number 46					
CF70	...Repeated for module number 47					
CF80	...Repeated for module number 48					
CF90	...Repeated for module number 49					
CFA0	...Repeated for module number 50					
CFB0	...Repeated for module number 51					
CFC0	...Repeated for module number 52					
CFD0	...Repeated for module number 53					
CFE0	...Repeated for module number 54					
CFF0	...Repeated for module number 55					
D000	...Repeated for module number 56					
D010	...Repeated for module number 57					
D020	...Repeated for module number 58					
D030	...Repeated for module number 59					
D040	...Repeated for module number 60					
D050	...Repeated for module number 61					
D060	...Repeated for module number 62					
D070	...Repeated for module number 63					
D080	...Repeated for module number 64					
Mandatory (Read/Write Setting)						
D280	Test Mode Function	0 to 1	---	1	F102	0 (Disabled)
Mandatory (Read/Write)						
D281	Force VFD and LED	0 to 1	---	1	F126	0 (No)
Mandatory (Read/Write Setting)						
D282	Test Mode Initiate	0 to 65535	---	1	F300	1
Mandatory (Read/Write Command)						
D283	Clear All Relay Records Command	0 to 1	---	1	F126	0 (No)
Contact Outputs (Read/Write Setting) (64 modules)						
D290	Contact Output 1 Name	---	---	---	F205	"Cont Op 1"
D29A	Contact Output 1 Operation	0 to 65535	---	1	F300	0
D29B	Contact Output 1 Seal In	0 to 65535	---	1	F300	0
D29C	Latching Output 1 Reset	0 to 65535	---	1	F300	0
D29D	Contact Output 1 Events	0 to 1	---	1	F102	1 (Enabled)
D29E	Latching Output 1 Type	0 to 1	---	1	F090	0 (Operate-dominant)
D29F	Reserved	---	---	---	F001	0
D2A0	...Repeated for module number 2					
D2B0	...Repeated for module number 3					
D2C0	...Repeated for module number 4					
D2D0	...Repeated for module number 5					
D2E0	...Repeated for module number 6					
D2F0	...Repeated for module number 7					
D300	...Repeated for module number 8					
D310	...Repeated for module number 9					
D320	...Repeated for module number 10					
D330	...Repeated for module number 11					
D340	...Repeated for module number 12					
D350	...Repeated for module number 13					
D360	...Repeated for module number 14					
D370	...Repeated for module number 15					
D380	...Repeated for module number 16					
D390	...Repeated for module number 17					
D3A0	...Repeated for module number 18					
D3B0	...Repeated for module number 19					
D3C0	...Repeated for module number 20					

B

Table B-9: MODBUS MEMORY MAP (Sheet 30 of 36)

ADDR	REGISTER NAME	RANGE	UNITS	STEP	FORMAT	DEFAULT
D3D0	...Repeated for module number 21					
D3E0	...Repeated for module number 22					
D3F0	...Repeated for module number 23					
D400	...Repeated for module number 24					
D410	...Repeated for module number 25					
D420	...Repeated for module number 26					
D430	...Repeated for module number 27					
D440	...Repeated for module number 28					
D450	...Repeated for module number 29					
D460	...Repeated for module number 30					
D470	...Repeated for module number 31					
D480	...Repeated for module number 32					
D490	...Repeated for module number 33					
D4A0	...Repeated for module number 34					
D4B0	...Repeated for module number 35					
D4C0	...Repeated for module number 36					
D4D0	...Repeated for module number 37					
D4E0	...Repeated for module number 38					
D4F0	...Repeated for module number 39					
D500	...Repeated for module number 40					
D510	...Repeated for module number 41					
D520	...Repeated for module number 42					
D530	...Repeated for module number 43					
D540	...Repeated for module number 44					
D550	...Repeated for module number 45					
D560	...Repeated for module number 46					
D570	...Repeated for module number 47					
D580	...Repeated for module number 48					
D590	...Repeated for module number 49					
D5A0	...Repeated for module number 50					
D5B0	...Repeated for module number 51					
D5C0	...Repeated for module number 52					
D5D0	...Repeated for module number 53					
D5E0	...Repeated for module number 54					
D5F0	...Repeated for module number 55					
D600	...Repeated for module number 56					
D610	...Repeated for module number 57					
D620	...Repeated for module number 58					
D630	...Repeated for module number 59					
D640	...Repeated for module number 60					
D650	...Repeated for module number 61					
D660	...Repeated for module number 62					
D670	...Repeated for module number 63					
D680	...Repeated for module number 64					
Reset (Read/Write Setting)						
D800	FlexLogic operand which initiates a reset	0 to 65535	---	1	F300	0
Control Pushbuttons (Read/Write Setting) (7 modules)						
D810	Control Pushbuttons 1 Function	0 to 1	---	1	F102	0 (Disabled)
D811	Control Pushbuttons 1 Events	0 to 1	---	1	F102	0 (Disabled)
D812	...Repeated for module number 2					
D814	...Repeated for module number 3					
D816	...Repeated for module number 4					
D818	...Repeated for module number 5					
D81A	...Repeated for module number 6					

B

Table B-9: MODBUS MEMORY MAP (Sheet 31 of 36)

ADDR	REGISTER NAME	RANGE	UNITS	STEP	FORMAT	DEFAULT
D81C	...Repeated for module number 7					
Clear Records (Read/Write Setting)						
D820	Clear Fault Reports operand	0 to 65535	---	1	F300	0
D822	Clear Event Records operand	0 to 65535	---	1	F300	0
D823	Clear Oscillography operand	0 to 65535	---	1	F300	0
D824	Clear Data Logger operand	0 to 65535	---	1	F300	0
D825	Clear Breaker 1 Arcing Current operand	0 to 65535	---	1	F300	0
D826	Clear Breaker 2 Arcing Current operand	0 to 65535	---	1	F300	0
D827	Clear Breaker 3 Arcing Current operand	0 to 65535	---	1	F300	0
D828	Clear Breaker 4 Arcing Current operand	0 to 65535	---	1	F300	0
D829	Clear Breaker 5 Arcing Current operand	0 to 65535	---	1	F300	0
D82A	Clear Breaker 6 Arcing Current operand	0 to 65535	---	1	F300	0
D82B	Clear Demand operand	0 to 65535	---	1	F300	0
D82D	Clear Energy operand	0 to 65535	---	1	F300	0
D82F	Clear Unauthorized Access operand	0 to 65535	---	1	F300	0
D831	Clear Platform Direct Input/Output Statistics operand	0 to 65535	---	1	F300	0
D832	Clear Relay Records Reserved (18 items)	---	---	---	F001	0
Force Contact Inputs (Read/Write Setting)						
D8B0	Force Contact Input x State (96 items)	0 to 2	---	1	F144	0 (Disabled)
Force Contact Outputs (Read/Write Setting)						
D910	Force Contact Output x State (64 items)	0 to 3	---	1	F131	0 (Disabled)
Direct Inputs/Outputs (Read/Write Setting)						
DB40	Direct Device ID	1 to 16	---	1	F001	1
DB41	Direct I/O Channel 1 Ring Configuration Function	0 to 1	---	1	F126	0 (No)
DB42	Platform Direct I/O Data Rate	64 to 128	kbps	64	F001	64
DB43	Direct I/O Channel 2 Ring Configuration Function	0 to 1	---	1	F126	0 (No)
DB44	Platform Direct I/O Crossover Function	0 to 1	---	1	F102	0 (Disabled)
Direct input/output commands (Read/Write Command)						
DB48	Direct input/output clear counters command	0 to 1	---	1	F126	0 (No)
Direct inputs (Read/Write Setting) (96 modules)						
DB50	Direct Input 1 Device Number	0 to 16	---	1	F001	0
DB51	Direct Input 1 Number	0 to 96	---	1	F001	0
DB52	Direct Input 1 Default State	0 to 3	---	1	F086	0 (Off)
DB53	Direct Input 1 Events	0 to 1	---	1	F102	0 (Disabled)
DB54	...Repeated for module number 2					
DB58	...Repeated for module number 3					
DB5C	...Repeated for module number 4					
DB60	...Repeated for module number 5					
DB64	...Repeated for module number 6					
DB68	...Repeated for module number 7					
DB6C	...Repeated for module number 8					
DB70	...Repeated for module number 9					
DB74	...Repeated for module number 10					
DB78	...Repeated for module number 11					
DB7C	...Repeated for module number 12					
DB80	...Repeated for module number 13					
DB84	...Repeated for module number 14					
DB88	...Repeated for module number 15					
DB8C	...Repeated for module number 16					
DB90	...Repeated for module number 17					
DB94	...Repeated for module number 18					
DB98	...Repeated for module number 19					
DB9C	...Repeated for module number 20					
DBA0	...Repeated for module number 21					

B

Table B-9: MODBUS MEMORY MAP (Sheet 32 of 36)

ADDR	REGISTER NAME	RANGE	UNITS	STEP	FORMAT	DEFAULT
DBA4	...Repeated for module number 22					
DBA8	...Repeated for module number 23					
DBAC	...Repeated for module number 24					
DBB0	...Repeated for module number 25					
DBB4	...Repeated for module number 26					
DBB8	...Repeated for module number 27					
DBBC	...Repeated for module number 28					
DBC0	...Repeated for module number 29					
DBC4	...Repeated for module number 30					
DBC8	...Repeated for module number 31					
DBCC	...Repeated for module number 32					
Platform Direct Outputs (Read/Write Setting) (96 modules)						
DD00	Direct Output 1 Operand	0 to 65535	---	1	F300	0
DD01	Direct Output 1 Events	0 to 1	---	1	F102	0 (Disabled)
DD02	...Repeated for module number 2					
DD04	...Repeated for module number 3					
DD06	...Repeated for module number 4					
DD08	...Repeated for module number 5					
DD0A	...Repeated for module number 6					
DD0C	...Repeated for module number 7					
DD0E	...Repeated for module number 8					
DD10	...Repeated for module number 9					
DD12	...Repeated for module number 10					
DD14	...Repeated for module number 11					
DD16	...Repeated for module number 12					
DD18	...Repeated for module number 13					
DD1A	...Repeated for module number 14					
DD1C	...Repeated for module number 15					
DD1E	...Repeated for module number 16					
DD20	...Repeated for module number 17					
DD22	...Repeated for module number 18					
DD24	...Repeated for module number 19					
DD26	...Repeated for module number 20					
DD28	...Repeated for module number 21					
DD2A	...Repeated for module number 22					
DD2C	...Repeated for module number 23					
DD2E	...Repeated for module number 24					
DD30	...Repeated for module number 25					
DD32	...Repeated for module number 26					
DD34	...Repeated for module number 27					
DD36	...Repeated for module number 28					
DD38	...Repeated for module number 29					
DD3A	...Repeated for module number 30					
DD3C	...Repeated for module number 31					
DD3E	...Repeated for module number 32					
Direct Input/Output Alarms (Read/Write Setting)						
DE00	Direct Input/Output Channel 1 CRC Alarm Function	0 to 1	---	1	F102	0 (Disabled)
DE01	Direct I/O Channel 1 CRC Alarm Message Count	100 to 10000	---	1	F001	600
DE02	Direct Input/Output Channel 1 CRC Alarm Threshold	1 to 1000	---	1	F001	10
DE03	Direct Input/Output Channel 1 CRC Alarm Events	0 to 1	---	1	F102	0 (Disabled)
DE04	Reserved (4 items)	1 to 1000	---	1	F001	10
DE08	Direct Input/Output Channel 2 CRC Alarm Function	0 to 1	---	1	F102	0 (Disabled)
DE09	Direct I/O Channel 2 CRC Alarm Message Count	100 to 10000	---	1	F001	600
DE0A	Direct Input/Output Channel 2 CRC Alarm Threshold	1 to 1000	---	1	F001	10

B

Table B-9: MODBUS MEMORY MAP (Sheet 33 of 36)

ADDR	REGISTER NAME	RANGE	UNITS	STEP	FORMAT	DEFAULT
DE0B	Direct Input/Output Channel 2 CRC Alarm Events	0 to 1	---	1	F102	0 (Disabled)
DE0C	Reserved (4 items)	1 to 1000	---	1	F001	10
DE10	Direct I/O Ch 1 Unreturned Messages Alarm Function	0 to 1	---	1	F102	0 (Disabled)
DE11	Direct I/O Ch 1 Unreturned Messages Alarm Msg Count	100 to 10000	---	1	F001	600
DE12	Direct I/O Ch 1 Unreturned Messages Alarm Threshold	1 to 1000	---	1	F001	10
DE13	Direct I/O Ch 1 Unreturned Messages Alarm Events	0 to 1	---	1	F102	0 (Disabled)
DE14	Reserved (4 items)	1 to 1000	---	1	F001	10
DE18	Direct IO Ch 2 Unreturned Messages Alarm Function	0 to 1	---	1	F102	0 (Disabled)
DE19	Direct I/O Ch 2 Unreturned Messages Alarm Msg Count	100 to 10000	---	1	F001	600
DE1A	Direct I/O Ch 2 Unreturned Messages Alarm Threshold	1 to 1000	---	1	F001	10
DE1B	Direct I/O Channel 2 Unreturned Messages Alarm Events	0 to 1	---	1	F102	0 (Disabled)
DE1C	Reserved (4 items)	1 to 1000	---	1	F001	10
Remote Devices (Read/Write Setting) (16 modules)						
E000	Remote Device 1 ID	---	---	---	F202	"Remote Device 1 "
E00A	...Repeated for module number 2					
E014	...Repeated for module number 3					
E01E	...Repeated for module number 4					
E028	...Repeated for module number 5					
E032	...Repeated for module number 6					
E03C	...Repeated for module number 7					
E046	...Repeated for module number 8					
E050	...Repeated for module number 9					
E05A	...Repeated for module number 10					
E064	...Repeated for module number 11					
E06E	...Repeated for module number 12					
E078	...Repeated for module number 13					
E082	...Repeated for module number 14					
E08C	...Repeated for module number 15					
E096	...Repeated for module number 16					
Remote Inputs (Read/Write Setting) (64 modules)						
E100	Remote Input 1 Device	1 to 16	---	1	F001	1
E101	Remote Input 1 Bit Pair	0 to 64	---	1	F156	0 (None)
E102	Remote Input 1 Default State	0 to 3	---	1	F086	0 (Off)
E103	Remote Input 1 Events	0 to 1	---	1	F102	0 (Disabled)
E104	...Repeated for module number 2					
E108	...Repeated for module number 3					
E10C	...Repeated for module number 4					
E110	...Repeated for module number 5					
E114	...Repeated for module number 6					
E118	...Repeated for module number 7					
E11C	...Repeated for module number 8					
E120	...Repeated for module number 9					
E124	...Repeated for module number 10					
E128	...Repeated for module number 11					
E12C	...Repeated for module number 12					
E130	...Repeated for module number 13					
E134	...Repeated for module number 14					
E138	...Repeated for module number 15					
E13C	...Repeated for module number 16					
E140	...Repeated for module number 17					
E144	...Repeated for module number 18					
E148	...Repeated for module number 19					
E14C	...Repeated for module number 20					
E150	...Repeated for module number 21					

B

Table B-9: MODBUS MEMORY MAP (Sheet 34 of 36)

ADDR	REGISTER NAME	RANGE	UNITS	STEP	FORMAT	DEFAULT
E154	...Repeated for module number 22					
E158	...Repeated for module number 23					
E15C	...Repeated for module number 24					
E160	...Repeated for module number 25					
E164	...Repeated for module number 26					
E168	...Repeated for module number 27					
E16C	...Repeated for module number 28					
E170	...Repeated for module number 29					
E174	...Repeated for module number 30					
E178	...Repeated for module number 31					
E17C	...Repeated for module number 32					
E180	...Repeated for module number 33					
E184	...Repeated for module number 34					
E188	...Repeated for module number 35					
E18C	...Repeated for module number 36					
E190	...Repeated for module number 37					
E194	...Repeated for module number 38					
E198	...Repeated for module number 39					
E19C	...Repeated for module number 40					
E1A0	...Repeated for module number 41					
E1A4	...Repeated for module number 42					
E1A8	...Repeated for module number 43					
E1AC	...Repeated for module number 44					
E1B0	...Repeated for module number 45					
E1B4	...Repeated for module number 46					
E1B8	...Repeated for module number 47					
E1BC	...Repeated for module number 48					
E1C0	...Repeated for module number 49					
E1C4	...Repeated for module number 50					
E1C8	...Repeated for module number 51					
E1CC	...Repeated for module number 52					
E1D0	...Repeated for module number 53					
E1D4	...Repeated for module number 54					
E1D8	...Repeated for module number 55					
E1DC	...Repeated for module number 56					
E1E0	...Repeated for module number 57					
E1E4	...Repeated for module number 58					
E1E8	...Repeated for module number 59					
E1EC	...Repeated for module number 60					
E1F0	...Repeated for module number 61					
E1F4	...Repeated for module number 62					
E1F8	...Repeated for module number 63					
E1FC	...Repeated for module number 64					
Remote Output DNA Pairs (Read/Write Setting) (32 modules)						
E600	Remote Output DNA 1 Operand	0 to 65535	---	1	F300	0
E601	Remote Output DNA 1 Events	0 to 1	---	1	F102	0 (Disabled)
E602	Remote Output DNA 1 Reserved (2 items)	0 to 1	---	1	F001	0
E604	...Repeated for module number 2					
E608	...Repeated for module number 3					
E60C	...Repeated for module number 4					
E610	...Repeated for module number 5					
E614	...Repeated for module number 6					
E618	...Repeated for module number 7					
E61C	...Repeated for module number 8					

Table B-9: MODBUS MEMORY MAP (Sheet 35 of 36)

ADDR	REGISTER NAME	RANGE	UNITS	STEP	FORMAT	DEFAULT
E620	...Repeated for module number 9					
E624	...Repeated for module number 10					
E628	...Repeated for module number 11					
E62C	...Repeated for module number 12					
E630	...Repeated for module number 13					
E634	...Repeated for module number 14					
E638	...Repeated for module number 15					
E63C	...Repeated for module number 16					
E640	...Repeated for module number 17					
E644	...Repeated for module number 18					
E648	...Repeated for module number 19					
E64C	...Repeated for module number 20					
E650	...Repeated for module number 21					
E654	...Repeated for module number 22					
E658	...Repeated for module number 23					
E65C	...Repeated for module number 24					
E660	...Repeated for module number 25					
E664	...Repeated for module number 26					
E668	...Repeated for module number 27					
E66C	...Repeated for module number 28					
E670	...Repeated for module number 29					
E674	...Repeated for module number 30					
E678	...Repeated for module number 31					
E67C	...Repeated for module number 32					
Remote Output UserSt Pairs (Read/Write Setting) (32 modules)						
E680	Remote Output UserSt 1 Operand	0 to 65535	---	1	F300	0
E681	Remote Output UserSt 1 Events	0 to 1	---	1	F102	0 (Disabled)
E682	Remote Output UserSt 1 Reserved (2 items)	0 to 1	---	1	F001	0
E684	...Repeated for module number 2					
E688	...Repeated for module number 3					
E68C	...Repeated for module number 4					
E690	...Repeated for module number 5					
E694	...Repeated for module number 6					
E698	...Repeated for module number 7					
E69C	...Repeated for module number 8					
E6A0	...Repeated for module number 9					
E6A4	...Repeated for module number 10					
E6A8	...Repeated for module number 11					
E6AC	...Repeated for module number 12					
E6B0	...Repeated for module number 13					
E6B4	...Repeated for module number 14					
E6B8	...Repeated for module number 15					
E6BC	...Repeated for module number 16					
E6C0	...Repeated for module number 17					
E6C4	...Repeated for module number 18					
E6C8	...Repeated for module number 19					
E6CC	...Repeated for module number 20					
E6D0	...Repeated for module number 21					
E6D4	...Repeated for module number 22					
E6D8	...Repeated for module number 23					
E6DC	...Repeated for module number 24					
E6E0	...Repeated for module number 25					
E6E4	...Repeated for module number 26					
E6E8	...Repeated for module number 27					

B

Table B-9: MODBUS MEMORY MAP (Sheet 36 of 36)

ADDR	REGISTER NAME	RANGE	UNITS	STEP	FORMAT	DEFAULT
E6EC	...Repeated for module number 28					
E6F0	...Repeated for module number 29					
E6F4	...Repeated for module number 30					
E6F8	...Repeated for module number 31					
E6FC	...Repeated for module number 32					

B.4.2 DATA FORMATS

F001
UR_UINT16 UNSIGNED 16 BIT INTEGER

F002
UR_SINT16 SIGNED 16 BIT INTEGER

F003
UR_UINT32 UNSIGNED 32 BIT INTEGER (2 registers)

High order word is stored in the first register.
Low order word is stored in the second register.

F004
UR_SINT32 SIGNED 32 BIT INTEGER (2 registers)

High order word is stored in the first register/
Low order word is stored in the second register.

F005
UR_UINT8 UNSIGNED 8 BIT INTEGER

F006
UR_SINT8 SIGNED 8 BIT INTEGER

F011
UR_UINT16 FLEXCURVE DATA (120 points)

A FlexCurve is an array of 120 consecutive data points (x, y) which are interpolated to generate a smooth curve. The y-axis is the user defined trip or operation time setting; the x-axis is the pickup ratio and is pre-defined. Refer to format F119 for a listing of the pickup ratios; the enumeration value for the pickup ratio indicates the offset into the FlexCurve base address where the corresponding time value is stored.

F012
DISPLAY_SCALE DISPLAY SCALING (unsigned 16-bit integer)

MSB indicates the SI units as a power of ten. LSB indicates the number of decimal points to display.

Example: Current values are stored as 32 bit numbers with three decimal places and base units in Amps. If the retrieved value is 12345.678 A and the display scale equals 0x0302 then the displayed value on the unit is 12.35 kA.

F013
POWER_FACTOR (SIGNED 16 BIT INTEGER)

Positive values indicate lagging power factor; negative values indicate leading.

F040
UR_UINT48 48-BIT UNSIGNED INTEGER

F050
UR_UINT32 TIME and DATE (UNSIGNED 32 BIT INTEGER)

Gives the current time in seconds elapsed since 00:00:00 January 1, 1970.

F051
UR_UINT32 DATE in SR format (alternate format for F050)

First 16 bits are Month/Day (MM/DD/xxxx). Month: 1=January, 2=February,...,12=December; Day: 1 to 31 in steps of 1
Last 16 bits are Year (xx/xx/YYYY): 1970 to 2106 in steps of 1

F052
UR_UINT32 TIME in SR format (alternate format for F050)

First 16 bits are Hours/Minutes (HH:MM:xx.xxx).
Hours: 0=12am, 1=1am,...,12=12pm,...23=11pm;
Minutes: 0 to 59 in steps of 1

Last 16 bits are Seconds (xx:xx:SS.SSS): 0=00.000s, 1=00.001,...,59999=59.999s)

F060
FLOATING_POINT IEEE FLOATING POINT (32 bits)

F070
HEX2 2 BYTES - 4 ASCII DIGITS

F071
HEX4 4 BYTES - 8 ASCII DIGITS

F072
HEX6 6 BYTES - 12 ASCII DIGITS

F073
HEX8 8 BYTES - 16 ASCII DIGITS

F074
HEX20 20 BYTES - 40 ASCII DIGITS

F080
ENUMERATION: AUTORECLOSE MODE

0 = 1 & 3 Pole, 1 = 1 Pole, 2 = 3 Pole-A, 3 = 3 Pole-B

F083
ENUMERATION: SELECTOR MODES

0 = Time-Out, 1 = Acknowledge

F084
ENUMERATION: SELECTOR POWER UP

0 = Restore, 1 = Synchronize, 2 = Sync/Restore

F086
ENUMERATION: DIGITAL INPUT DEFAULT STATE

0 = Off, 1 = On, 2 = Latest/Off, 3 = Latest/On

F090
ENUMERATION: LATCHING OUTPUT TYPE

0 = Operate-dominant, 1 = Reset-dominant

F100
ENUMERATION: VT CONNECTION TYPE

0 = Wye; 1 = Delta

F101
ENUMERATION: MESSAGE DISPLAY INTENSITY

0 = 25%, 1 = 50%, 2 = 75%, 3 = 100%

F102
ENUMERATION: DISABLED/ENABLED

0 = Disabled; 1 = Enabled

F103
ENUMERATION: CURVE SHAPES

bitmask	curve shape
0	IEEE Mod Inv
1	IEEE Very Inv
2	IEEE Ext Inv
3	IEC Curve A
4	IEC Curve B
5	IEC Curve C
6	IEC Short Inv
7	IAC Ext Inv
8	IAC Very Inv

bitmask	curve shape
9	IAC Inverse
10	IAC Short Inv
11	I2t
12	Definite Time
13	FlexCurve™ A
14	FlexCurve™ B
15	FlexCurve™ C
16	FlexCurve™ D

F104
ENUMERATION: RESET TYPE

0 = Instantaneous, 1 = Timed, 2 = Linear

F105
ENUMERATION: LOGIC INPUT

0 = Disabled, 1 = Input 1, 2 = Input 2

F106
ENUMERATION: PHASE ROTATION

0 = ABC, 1 = ACB

F108
ENUMERATION: OFF/ON

0 = Off, 1 = On

F109
ENUMERATION: CONTACT OUTPUT OPERATION

0 = Self-reset, 1 = Latched, 2 = Disabled

F110
ENUMERATION: CONTACT OUTPUT LED CONTROL

0 = Trip, 1 = Alarm, 2 = None

F111
ENUMERATION: UNDERVOLTAGE CURVE SHAPES

0 = Definite Time, 1 = Inverse Time

F112

ENUMERATION: RS485 BAUD RATES

bitmask	value	bitmask	value	bitmask	value
0	300	4	9600	8	115200
1	1200	5	19200	9	14400
2	2400	6	38400	10	28800
3	4800	7	57600	11	33600

F113

ENUMERATION: PARITY

0 = None, 1 = Odd, 2 = Even

F114

ENUMERATION: IRIG-B SIGNAL TYPE

0 = None, 1 = DC Shift, 2 = Amplitude Modulated

F117

ENUMERATION: NUMBER OF OSCILLOGRAPHY RECORDS

0 = 1×72 cycles, 1 = 3×36 cycles, 2 = 7×18 cycles, 3 = 15×9 cycles

F118

ENUMERATION: OSCILLOGRAPHY MODE

0 = Automatic Overwrite, 1 = Protected

F119

ENUMERATION: FLEXCURVE™ PICKUP RATIOS

mask	value	mask	value	mask	value	mask	value
0	0.00	30	0.88	60	2.90	90	5.90
1	0.05	31	0.90	61	3.00	91	6.00
2	0.10	32	0.91	62	3.10	92	6.50
3	0.15	33	0.92	63	3.20	93	7.00
4	0.20	34	0.93	64	3.30	94	7.50
5	0.25	35	0.94	65	3.40	95	8.00
6	0.30	36	0.95	66	3.50	96	8.50
7	0.35	37	0.96	67	3.60	97	9.00
8	0.40	38	0.97	68	3.70	98	9.50
9	0.45	39	0.98	69	3.80	99	10.00
10	0.48	40	1.03	70	3.90	100	10.50
11	0.50	41	1.05	71	4.00	101	11.00
12	0.52	42	1.10	72	4.10	102	11.50
13	0.54	43	1.20	73	4.20	103	12.00
14	0.56	44	1.30	74	4.30	104	12.50
15	0.58	45	1.40	75	4.40	105	13.00
16	0.60	46	1.50	76	4.50	106	13.50
17	0.62	47	1.60	77	4.60	107	14.00
18	0.64	48	1.70	78	4.70	108	14.50
19	0.66	49	1.80	79	4.80	109	15.00
20	0.68	50	1.90	80	4.90	110	15.50
21	0.70	51	2.00	81	5.00	111	16.00
22	0.72	52	2.10	82	5.10	112	16.50
23	0.74	53	2.20	83	5.20	113	17.00
24	0.76	54	2.30	84	5.30	114	17.50
25	0.78	55	2.40	85	5.40	115	18.00
26	0.80	56	2.50	86	5.50	116	18.50
27	0.82	57	2.60	87	5.60	117	19.00
28	0.84	58	2.70	88	5.70	118	19.50
29	0.86	59	2.80	89	5.80	119	20.00

F122

ENUMERATION: ELEMENT INPUT SIGNAL TYPE

0 = Phasor, 1 = RMS

F123

ENUMERATION: CT SECONDARY

0 = 1 A, 1 = 5 A

F124

ENUMERATION: LIST OF ELEMENTS

bitmask	element
0	Phase Instantaneous Overcurrent 1
1	Phase Instantaneous Overcurrent 2
2	Phase Instantaneous Overcurrent 3
3	Phase Instantaneous Overcurrent 4
4	Phase Instantaneous Overcurrent 5

bitmask	element
5	Phase Instantaneous Overcurrent 6
6	Phase Instantaneous Overcurrent 7
7	Phase Instantaneous Overcurrent 8
8	Phase Instantaneous Overcurrent 9
9	Phase Instantaneous Overcurrent 10
10	Phase Instantaneous Overcurrent 11
11	Phase Instantaneous Overcurrent 12
16	Phase Time Overcurrent 1
17	Phase Time Overcurrent 2
18	Phase Time Overcurrent 3
19	Phase Time Overcurrent 4
20	Phase Time Overcurrent 5
21	Phase Time Overcurrent 6
24	Phase Directional Overcurrent 1
25	Phase Directional Overcurrent 2
32	Neutral Instantaneous Overcurrent 1
33	Neutral Instantaneous Overcurrent 2
34	Neutral Instantaneous Overcurrent 3
35	Neutral Instantaneous Overcurrent 4
36	Neutral Instantaneous Overcurrent 5
37	Neutral Instantaneous Overcurrent 6
38	Neutral Instantaneous Overcurrent 7
39	Neutral Instantaneous Overcurrent 8
40	Neutral Instantaneous Overcurrent 9
41	Neutral Instantaneous Overcurrent 10
42	Neutral Instantaneous Overcurrent 11
43	Neutral Instantaneous Overcurrent 12
48	Neutral Time Overcurrent 1
49	Neutral Time Overcurrent 2
50	Neutral Time Overcurrent 3
51	Neutral Time Overcurrent 4
52	Neutral Time Overcurrent 5
53	Neutral Time Overcurrent 6
56	Neutral Directional Overcurrent 1
57	Neutral Directional Overcurrent 2
60	Negative Sequence Directional Overcurrent 1
61	Negative Sequence Directional Overcurrent 2
64	Ground Instantaneous Overcurrent 1
65	Ground Instantaneous Overcurrent 2
66	Ground Instantaneous Overcurrent 3
67	Ground Instantaneous Overcurrent 4
68	Ground Instantaneous Overcurrent 5
69	Ground Instantaneous Overcurrent 6
70	Ground Instantaneous Overcurrent 7
71	Ground Instantaneous Overcurrent 8
72	Ground Instantaneous Overcurrent 9
73	Ground Instantaneous Overcurrent 10
74	Ground Instantaneous Overcurrent 11
75	Ground Instantaneous Overcurrent 12
80	Ground Time Overcurrent 1
81	Ground Time Overcurrent 2
82	Ground Time Overcurrent 3
83	Ground Time Overcurrent 4

bitmask	element
84	Ground Time Overcurrent 5
85	Ground Time Overcurrent 6
96	Negative Sequence Instantaneous Overcurrent 1
97	Negative Sequence Instantaneous Overcurrent 2
112	Negative Sequence Time Overcurrent 1
113	Negative Sequence Time Overcurrent 2
120	Negative Sequence Overvoltage
140	Auxiliary Undervoltage 1
144	Phase Undervoltage 1
145	Phase Undervoltage 2
148	Auxiliary Overvoltage 1
152	Phase Overvoltage 1
156	Neutral Overvoltage 1
180	Load Enchroachment
190	Power Swing Detect
288	Breaker Arcing Current 1
289	Breaker Arcing Current 2
290	Breaker Arcing Current 3
291	Breaker Arcing Current 4
292	Breaker Arcing Current 5
293	Breaker Arcing Current 6
304	Autoreclose 1
305	Autoreclose 2
306	Autoreclose 3
307	Autoreclose 4
308	Autoreclose 5
309	Autoreclose 6
336	Setting Group
337	Reset
352	Underfrequency 1
353	Underfrequency 2
354	Underfrequency 3
355	Underfrequency 4
356	Underfrequency 5
357	Underfrequency 6
375	Autoreclose
385	Selector 1
386	Selector 2
390	Control Pushbutton 1
391	Control Pushbutton 2
392	Control Pushbutton 3
393	Control Pushbutton 4
394	Control Pushbutton 5
395	Control Pushbutton 6
396	Control Pushbutton 7
400	FlexElement™ 1
401	FlexElement™ 2
402	FlexElement™ 3
403	FlexElement™ 4
404	FlexElement™ 5
405	FlexElement™ 6
406	FlexElement™ 7
407	FlexElement™ 8

bitmask	element
408	FlexElement™ 9
409	FlexElement™ 10
410	FlexElement™ 11
411	FlexElement™ 12
412	FlexElement™ 13
413	FlexElement™ 14
414	FlexElement™ 15
415	FlexElement™ 16
420	Non-volatile Latch 1
421	Non-volatile Latch 2
422	Non-volatile Latch 3
423	Non-volatile Latch 4
424	Non-volatile Latch 5
425	Non-volatile Latch 6
426	Non-volatile Latch 7
427	Non-volatile Latch 8
428	Non-volatile Latch 9
429	Non-volatile Latch 10
430	Non-volatile Latch 11
431	Non-volatile Latch 12
432	Non-volatile Latch 13
433	Non-volatile Latch 14
434	Non-volatile Latch 15
435	Non-volatile Latch 16
512	Digital Element 1
513	Digital Element 2
514	Digital Element 3
515	Digital Element 4
516	Digital Element 5
517	Digital Element 6
518	Digital Element 7
519	Digital Element 8
520	Digital Element 9
521	Digital Element 10
522	Digital Element 11
523	Digital Element 12
524	Digital Element 13
525	Digital Element 14
526	Digital Element 15
527	Digital Element 16
544	Digital Counter 1
545	Digital Counter 2
546	Digital Counter 3
547	Digital Counter 4
548	Digital Counter 5
549	Digital Counter 6
550	Digital Counter 7
551	Digital Counter 8
680	User-Programmable Pushbutton 1
681	User-Programmable Pushbutton 2
682	User-Programmable Pushbutton 3

bitmask	element
683	User-Programmable Pushbutton 4
684	User-Programmable Pushbutton 5
685	User-Programmable Pushbutton 6
686	User-Programmable Pushbutton 7
687	User-Programmable Pushbutton 8
688	User-Programmable Pushbutton 9
689	User-Programmable Pushbutton 10
690	User-Programmable Pushbutton 11
691	User-Programmable Pushbutton 12

F125
ENUMERATION: ACCESS LEVEL

0 = Restricted; 1 = Command, 2 = Setting, 3 = Factory Service

F126
ENUMERATION: NO/YES CHOICE

0 = No, 1 = Yes

F127
ENUMERATION: LATCHED OR SELF-RESETTING

0 = Latched, 1 = Self-Reset

F128
ENUMERATION: CONTACT INPUT THRESHOLD

0 = 17 V DC, 1 = 33 V DC, 2 = 84 V DC, 3 = 166 V DC

F129
ENUMERATION: FLEXLOGIC TIMER TYPE

0 = millisecond, 1 = second, 2 = minute

F130
ENUMERATION: SIMULATION MODE

0 = Off. 1 = Pre-Fault, 2 = Fault, 3 = Post-Fault

F131
ENUMERATION: FORCED CONTACT OUTPUT STATE

0 = Disabled, 1 = Energized, 2 = De-energized, 3 = Freeze

F132
ENUMERATION: DEMAND INTERVAL

0 = 5 min, 1 = 10 min, 2 = 15 min, 3 = 20 min, 4 = 30 min,
5 = 60 min

F133
ENUMERATION: PROGRAM STATE

0 = Not Programmed, 1 = Programmed

F134
ENUMERATION: PASS/FAIL

0 = Fail, 1 = OK, 2 = n/a

F135
ENUMERATION: GAIN CALIBRATION

0 = 0x1, 1 = 1x16

F136
ENUMERATION: NUMBER OF OSCILLOGRAPHY RECORDS

0 = 31 x 8 cycles, 1 = 15 x 16 cycles, 2 = 7 x 32 cycles
 3 = 3 x 64 cycles, 4 = 1 x 128 cycles

F138
ENUMERATION: OSCILLOGRAPHY FILE TYPE

0 = Data File, 1 = Configuration File, 2 = Header File

F139
ENUMERATION: DEMAND CALCULATIONS

0 = Thermal Exponential, 1 = Block Interval, 2 = Rolling Demand

F140
ENUMERATION: CURRENT, SENS CURRENT, VOLTAGE, DISABLED

0 = Disabled, 1 = Current 46 A, 2 = Voltage 280 V, 3 = Current 4.6 A, 4 = Current 2 A, 5 = Notched 4.6 A, 6 = Notched 2 A

F141
ENUMERATION: SELF TEST ERROR

bitmask	error
0	Any Self Tests
1	IRIG-B Failure
2	DSP Error
4	No DSP Interrupts
5	Unit Not Calibrated
9	Prototype Firmware
10	Flexlogic Error Token
11	Equipment Mismatch
13	Unit Not Programmed
14	System Exception
15	Latching Out Error
18	SNTP Failure
19	Battery Failure
20	Primary Ethernet Failure
21	Secondary Ethernet Failure
22	EEPROM Data Error
23	SRAM Data Error
24	Program Memory
25	Watchdog Error

bitmask	error
26	Low On Memory
27	Remote Device Off
28	Direct Device Off
29	Direct Ring Break
30	Any Minor Error
31	Any Major Error

F142
ENUMERATION: EVENT RECORDER ACCESS FILE TYPE

0 = All Record Data, 1 = Headers Only, 2 = Numeric Event Cause

F143
UR_UINT32: 32 BIT ERROR CODE (F141 specifies bit number)

A bit value of 0 = no error, 1 = error

F144
ENUMERATION: FORCED CONTACT INPUT STATE

0 = Disabled, 1 = Open, 2 = Closed

F145
ENUMERATION: ALPHABET LETTER

bitmask	type	bitmask	type	bitmask	type	bitmask	type
0	null	7	G	14	N	21	U
1	A	8	H	15	O	22	V
2	B	9	I	16	P	23	W
3	C	10	J	17	Q	24	X
4	D	11	K	18	R	25	Y
5	E	12	L	19	S	26	Z
6	F	13	M	20	T		

F146
ENUMERATION: MISC. EVENT CAUSES

bitmask	definition
0	Events Cleared
1	Oscillography Triggered
2	Date/time Changed
3	Default Settings Loaded
4	Test Mode On
5	Test Mode Off
6	Power On
7	Power Off
8	Relay In Service
9	Relay Out Of Service
10	Watchdog Reset
11	Oscillography Clear
12	Reboot Command
13	Led Test Initiated
14	Flash Programming
15	Fault Report Trigger

bitmask	definition
16	User Programmable Fault Report Trigger

F151
ENUMERATION: RTD SELECTION

bitmask	RTD#	bitmask	RTD#	bitmask	RTD#
0	NONE	17	RTD 17	33	RTD 33
1	RTD 1	18	RTD 18	34	RTD 34
2	RTD 2	19	RTD 19	35	RTD 35
3	RTD 3	20	RTD 20	36	RTD 36
4	RTD 4	21	RTD 21	37	RTD 37
5	RTD 5	22	RTD 22	38	RTD 38
6	RTD 6	23	RTD 23	39	RTD 39
7	RTD 7	24	RTD 24	40	RTD 40
8	RTD 8	25	RTD 25	41	RTD 41
9	RTD 9	26	RTD 26	42	RTD 42
10	RTD 10	27	RTD 27	43	RTD 43
11	RTD 11	28	RTD 28	44	RTD 44
12	RTD 12	29	RTD 29	45	RTD 45
13	RTD 13	30	RTD 30	46	RTD 46
14	RTD 14	31	RTD 31	47	RTD 47
15	RTD 15	32	RTD 32	48	RTD 48
16	RTD 16				

F152
ENUMERATION: SETTING GROUP

0 = Active Group, 1 = Group 1, 2 = Group 2, 3 = Group 3
 4 = Group 4, 5 = Group 5, 6 = Group 6

F155
ENUMERATION: REMOTE DEVICE STATE

0 = Offline, 1 = Online

F156
ENUMERATION: REMOTE INPUT BIT PAIRS

bitmask	RTD#	bitmask	RTD#	bitmask	RTD#
0	NONE	22	DNA-22	44	UserSt-12
1	DNA-1	23	DNA-23	45	UserSt-13
2	DNA-2	24	DNA-24	46	UserSt-14
3	DNA-3	25	DNA-25	47	UserSt-15
4	DNA-4	26	DNA-26	48	UserSt-16
5	DNA-5	27	DNA-27	49	UserSt-17
6	DNA-6	28	DNA-28	50	UserSt-18
7	DNA-7	29	DNA-29	51	UserSt-19
8	DNA-8	30	DNA-30	52	UserSt-20
9	DNA-9	31	DNA-31	53	UserSt-21
10	DNA-10	32	DNA-32	54	UserSt-22
11	DNA-11	33	UserSt-1	55	UserSt-23
12	DNA-12	34	UserSt-2	56	UserSt-24
13	DNA-13	35	UserSt-3	57	UserSt-25
14	DNA-14	36	UserSt-4	58	UserSt-26
15	DNA-15	37	UserSt-5	59	UserSt-27
16	DNA-16	38	UserSt-6	60	UserSt-28
17	DNA-17	39	UserSt-7	61	UserSt-29
18	DNA-18	40	UserSt-8	62	UserSt-30
19	DNA-19	41	UserSt-9	63	UserSt-31
20	DNA-20	42	UserSt-10	64	UserSt-32
21	DNA-21	43	UserSt-11		

F166
ENUMERATION: AUXILIARY VT CONNECTION TYPE

0 = Vn, 1 = Vag, 2 = Vbg, 3 = Vcg, 4 = Vab, 5 = Vbc, 6 = Vca

F167
ENUMERATION: SIGNAL SOURCE

0 = SRC 1, 1 = SRC 2, 2 = SRC 3, 3 = SRC 4,
 4 = SRC 5, 5 = SRC 6

F168
ENUMERATION: INRUSH INHIBIT FUNCTION

0 = Disabled, 1 = Adapt. 2nd, 2 = Trad. 2nd

F170
ENUMERATION: LOW/HIGH OFFSET and GAIN
TRANSDUCER INPUT/OUTPUT SELECTION

0 = LOW, 1 = HIGH

F171
ENUMERATION: TRANSDUCER CHANNEL INPUT TYPE

0 = dcmA IN, 1 = Ohms IN, 2 = RTD IN, 3 = dcmA OUT

F172
ENUMERATION: SLOT LETTERS

bitmask	slot	bitmask	slot	bitmask	slot	bitmask	slot
0	F	4	K	8	P	12	U
1	G	5	L	9	R	13	V
2	H	6	M	10	S	14	W
3	J	7	N	11	T	15	X

F173
ENUMERATION: TRANSDUCER DCMA I/O RANGE

bitmask	dcmA I/O range
0	0 to -1 mA
1	0 to 1 mA
2	-1 to 1 mA
3	0 to 5 mA
4	0 to 10 mA
5	0 to 20 mA
6	4 to 20 mA

F174
ENUMERATION: TRANSDUCER RTD INPUT TYPE

0 = 100 Ohm Platinum, 1 = 120 Ohm Nickel,
 2 = 100 Ohm Nickel, 3 = 10 Ohm Copper

F175
ENUMERATION: PHASE LETTERS

0 = A, 1 = B, 2 = C

F177
ENUMERATION: COMMUNICATION PORT

0 = None, 1 = COM1-RS485, 2 = COM2-RS485,
 3 = Front Panel-RS232, 4 = Network

F178
ENUMERATION: DATA LOGGER RATES

0 = 1 sec, 1 = 1 min, 2 = 5 min, 3 = 10 min, 4 = 15 min,
 5 = 20 min, 6 = 30 min, 7 = 60 min

F179
ENUMERATION: NEGATIVE SEQUENCE DIRECTIONAL OVERCURRENT TYPE

0 = Neg Sequence, 1 = Zero Sequence

F180
ENUMERATION: PHASE/GROUND

0 = PHASE, 1 = GROUND

F181
ENUMERATION: ODD/EVEN/NONE

0 = ODD, 1 = EVEN, 2 = NONE

F183
ENUMERATION: AC INPUT WAVEFORMS

bitmask	definition
0	Off
1	8 samples/cycle
2	16 samples/cycle
3	32 samples/cycle
4	64 samples/cycle

F185
ENUMERATION: PHASE A,B,C, GROUND SELECTOR

0 = A, 1 = B, 2 = C, 3 = G

F186
ENUMERATION: MEASUREMENT MODE

0 = Phase to Ground, 1 = Phase to Phase

F190
ENUMERATION: SIMULATED KEYPRESS

bitmsk	keypress
0	--- use between real keys
1	1
2	2
3	3
4	4
5	5
6	6
7	7
8	8
9	9
10	0
11	Decimal Pt
12	Plus/Minus
13	Value Up
14	Value Down
15	Message Up
16	Message Down
17	Message Left
18	Message Right
19	Menu
20	Help

bitmsk	keypress
21	Escape
22	Enter
23	Reset
24	User 1
25	User 2
26	User 3
27	User-programmable key 1
28	User-programmable key 2
29	User-programmable key 3
30	User-programmable key 4
31	User-programmable key 5
32	User-programmable key 6
33	User-programmable key 7
34	User-programmable key 8
35	User-programmable key 9
36	User-programmable key 10
37	User-programmable key 11
38	User-programmable key 12
39	User 4 (control pushbutton)
40	User 5 (control pushbutton)
41	User 6 (control pushbutton)
42	User 7 (control pushbutton)

F192

ENUMERATION: ETHERNET OPERATION MODE

0 = Half-Duplex, 1 = Full-Duplex

F194

ENUMERATION: DNP SCALE

A bitmask of 0 = 0.01, 1 = 0.1, 2 = 1, 3 = 10, 4 = 100, 5 = 1000, 6 = 10000, 7 = 100000, 8 = 0.001

F197

ENUMERATION: DNP BINARY INPUT POINT BLOCK

bitmask	Input Point Block
0	Not Used
1	Virtual Inputs 1 to 16
2	Virtual Inputs 17 to 32
3	Virtual Outputs 1 to 16
4	Virtual Outputs 17 to 32
5	Virtual Outputs 33 to 48
6	Virtual Outputs 49 to 64
7	Contact Inputs 1 to 16
8	Contact Inputs 17 to 32
9	Contact Inputs 33 to 48
10	Contact Inputs 49 to 64
11	Contact Inputs 65 to 80
12	Contact Inputs 81 to 96
13	Contact Outputs 1 to 16
14	Contact Outputs 17 to 32
15	Contact Outputs 33 to 48
16	Contact Outputs 49 to 64
17	Remote Inputs 1 to 16
18	Remote Inputs 17 to 32
19	Remote Devs 1 to 16
20	Elements 1 to 16
21	Elements 17 to 32
22	Elements 33 to 48
23	Elements 49 to 64
24	Elements 65 to 80
25	Elements 81 to 96
26	Elements 97 to 112
27	Elements 113 to 128
28	Elements 129 to 144
29	Elements 145 to 160
30	Elements 161 to 176
31	Elements 177 to 192
32	Elements 193 to 208
33	Elements 209 to 224
34	Elements 225 to 240
35	Elements 241 to 256
36	Elements 257 to 272
37	Elements 273 to 288
38	Elements 289 to 304

bitmask	Input Point Block
39	Elements 305 to 320
40	Elements 321 to 336
41	Elements 337 to 352
42	Elements 353 to 368
43	Elements 369 to 384
44	Elements 385 to 400
45	Elements 401 to 406
46	Elements 417 to 432
47	Elements 433 to 448
48	Elements 449 to 464
49	Elements 465 to 480
50	Elements 481 to 496
51	Elements 497 to 512
52	Elements 513 to 528
53	Elements 529 to 544
54	Elements 545 to 560
55	LED States 1 to 16
56	LED States 17 to 32
57	Self Tests 1 to 16
58	Self Tests 17 to 32

F199

ENUMERATION: DISABLED/ENABLED/CUSTOM

0 = Disabled, 1 = Enabled, 2 = Custom

F200

TEXT40: 40-CHARACTER ASCII TEXT

20 registers, 16 Bits: 1st Char MSB, 2nd Char. LSB

F201

TEXT8: 8-CHARACTER ASCII PASSCODE

4 registers, 16 Bits: 1st Char MSB, 2nd Char. LSB

F202

TEXT20: 20-CHARACTER ASCII TEXT

10 registers, 16 Bits: 1st Char MSB, 2nd Char. LSB

F203

TEXT16: 16-CHARACTER ASCII TEXT

F204

TEXT80: 80-CHARACTER ASCII TEXT

F205

TEXT12: 12-CHARACTER ASCII TEXT

F206

TEXT6: 6-CHARACTER ASCII TEXT

F207
TEXT4: 4-CHARACTER ASCII TEXT

F208
TEXT2: 2-CHARACTER ASCII TEXT

F222
ENUMERATION: TEST ENUMERATION

0 = Test Enumeration 0, 1 = Test Enumeration 1

F300
UR_UINT16: FLEXLOGIC™ BASE TYPE (6-bit type)

The FlexLogic™ BASE type is 6 bits and is combined with a 9 bit descriptor and 1 bit for protection element to form a 16 bit value. The combined bits are of the form: PTTTTTDDDDDDDDDD, where P bit if set, indicates that the FlexLogic™ type is associated with a protection element state and T represents bits for the BASE type, and D represents bits for the descriptor.

The values in square brackets indicate the base type with P prefix [PTTTTTT] and the values in round brackets indicate the descriptor range.

- [0] Off(0) this is boolean FALSE value
- [0] On (1) This is boolean TRUE value
- [2] CONTACT INPUTS (1 - 96)
- [3] CONTACT INPUTS OFF (1-96)
- [4] VIRTUAL INPUTS (1-64)
- [6] VIRTUAL OUTPUTS (1-64)
- [10] CONTACT OUTPUTS VOLTAGE DETECTED (1-64)
- [11] CONTACT OUTPUTS VOLTAGE OFF DETECTED (1-64)
- [12] CONTACT OUTPUTS CURRENT DETECTED (1-64)
- [13] CONTACT OUTPUTS CURRENT OFF DETECTED (1-64)
- [14] REMOTE INPUTS (1-32)
- [28] INSERT (Via Keypad only)
- [32] END
- [34] NOT (1 INPUT)
- [36] 2 INPUT XOR (0)
- [38] LATCH SET/RESET (2 inputs)
- [40] OR (2 to 16 inputs)
- [42] AND (2 to 16 inputs)
- [44] NOR (2 to 16 inputs)
- [46] NAND (2 to 16 inputs)
- [48] TIMER (1 to 32)
- [50] ASSIGN VIRTUAL OUTPUT (1 to 64)
- [52] SELF-TEST ERROR (see F141 for range)
- [56] ACTIVE SETTING GROUP (1 to 6)
- [62] MISCELLANEOUS EVENTS (see F146 for range)
- [64 to 127] ELEMENT STATES

F400
UR_UINT16: CT/VT BANK SELECTION

bitmask	bank selection
0	Card 1 Contact 1 to 4
1	Card 1 Contact 5 to 8
2	Card 2 Contact 1 to 4
3	Card 2 Contact 5 to 8
4	Card 3 Contact 1 to 4
5	Card 3 Contact 5 to 8

F500
UR_UINT16: PACKED BITFIELD

First register indicates input/output state with bits 0(MSB)-15(LSB) corresponding to input/output state 1-16. The second register indicates input/output state with bits 0-15 corresponding to input/output state 17-32 (if required) The third register indicates input/output state with bits 0-15 corresponding to input/output state 33-48 (if required). The fourth register indicates input/output state with bits 0-15 corresponding to input/output state 49-64 (if required).

The number of registers required is determined by the specific data item. A bit value of 0 = Off, 1 = On

F501
UR_UINT16: LED STATUS

Low byte of register indicates LED status with bit 0 representing the top LED and bit 7 the bottom LED. A bit value of 1 indicates the LED is on, 0 indicates the LED is off.

F502
BITFIELD: ELEMENT OPERATE STATES

Each bit contains the operate state for an element. See the F124 format code for a list of element IDs. The operate bit for element ID X is bit [X mod 16] in register [X/16].

F504
BITFIELD: 3-PHASE ELEMENT STATE

bitmask	element state
0	Pickup
1	Operate
2	Pickup Phase A
3	Pickup Phase B
4	Pickup Phase C
5	Operate Phase A
6	Operate Phase B
7	Operate Phase C

F505
BITFIELD: CONTACT OUTPUT STATE

0 = Contact State, 1 = Voltage Detected, 2 = Current Detected

F506|
BITFIELD: 1 PHASE ELEMENT STATE

0 = Pickup, 1 = Operate

F507
BITFIELD: COUNTER ELEMENT STATE

0 = Count Greater Than, 1 = Count Equal To, 2 = Count Less Than

F509
BITFIELD: SIMPLE ELEMENT STATE

0 = Operate

F511
BITFIELD: 3-PHASE SIMPLE ELEMENT STATE

0 = Operate, 1 = Operate A, 2 = Operate B, 3 = Operate C

F515
ENUMERATION ELEMENT INPUT MODE

0 = SIGNED, 1 = ABSOLUTE

F516
ENUMERATION ELEMENT COMPARE MODE

0 = LEVEL, 1 = DELTA

F518
ENUMERATION: FLEXELEMENT™ UNITS

0 = Milliseconds, 1 = Seconds, 2 = Minutes

F519
ENUMERATION: NON-VOLATILE LATCH

0 = Reset-Dominant, 1 = Set-Dominant

F522
ENUMERATION: TRANSDUCER DCMA OUTPUT RANGE

0 = -1 to 1 mA; 1 = 0 to 1 mA; 2 = 4 to 20 mA

F523
ENUMERATION: DNP OBJECTS 20, 22, AND 23 DEFAULT VARIATION

bitmask	Default Variation
0	1
1	2
2	5
3	6

F524
ENUMERATION: DNP OBJECT 21 DEFAULT VARIATION

bitmask	Default Variation
0	1
1	2
2	9
3	10

F525
ENUMERATION: DNP OBJECT 32 DEFAULT VARIATION

bitmask	Default Variation
0	1
1	2
2	3
3	4
4	5
5	7

F530
ENUMERATION: FRONT PANEL INTERFACE KEYPRESS

bitmask	keypress
0	None
1	Menu
2	Message Up
3	7
4	8
5	9
6	Help
7	Message Left
8	4
9	5
10	6
11	Escape
12	Message Right
13	1
14	2
15	3
16	Enter
17	Message Down
18	0
19	Decimal
20	+/-
21	Value Up

bitmask	keypress
22	Value Down
23	Reset
24	User 1
25	User 2
26	User 3
31	User PB 1
32	User PB 2
33	User PB 3
34	User PB 4
35	User PB 5
36	User PB 6
37	User PB 7
38	User PB 8
39	User PB 9
40	User PB 10
41	User PB 11
42	User PB 12
44	User 4
45	User 5
46	User 6
47	User 7

F600
UR_UINT16: FLEXANALOG PARAMETER

Corresponds to the modbus address of the value used when this parameter is selected. Only certain values may be used as Flex-Analogs (basically all metering quantities used in protection)

B

C.1.1 INTEROPERABILITY DOCUMENT

This document is adapted from the IEC 60870-5-104 standard. For this section the boxes indicate the following: – used in standard direction; – not used; – cannot be selected in IEC 60870-5-104 standard.

1. SYSTEM OR DEVICE:

- System Definition
- Controlling Station Definition (Master)
- Controlled Station Definition (Slave)

2. NETWORK CONFIGURATION:

- Point to Point
- Multipoint
- Multiple Point to Point
- Multipoint Star

3. PHYSICAL LAYER

Transmission Speed (control direction):

Unbalanced Interchange Circuit V.24/V.28 Standard:	Unbalanced Interchange Circuit V.24/V.28 Recommended if >1200 bits/s:	Balanced Interchange Circuit X.24/X.27:
<input type="checkbox"/> 100 bits/sec. <input type="checkbox"/> 200 bits/sec. <input type="checkbox"/> 300 bits/sec. <input type="checkbox"/> 600 bits/sec. <input type="checkbox"/> 1200 bits/sec.	<input type="checkbox"/> 2400 bits/sec. <input type="checkbox"/> 4800 bits/sec. <input type="checkbox"/> 9600 bits/sec.	<input type="checkbox"/> 2400 bits/sec. <input type="checkbox"/> 4800 bits/sec. <input type="checkbox"/> 9600 bits/sec. <input type="checkbox"/> 19200 bits/sec. <input type="checkbox"/> 38400 bits/sec. <input type="checkbox"/> 56000 bits/sec. <input type="checkbox"/> 64000 bits/sec.

Transmission Speed (monitor direction):

Unbalanced Interchange Circuit V.24/V.28 Standard:	Unbalanced Interchange Circuit V.24/V.28 Recommended if >1200 bits/s:	Balanced Interchange Circuit X.24/X.27:
<input type="checkbox"/> 100 bits/sec. <input type="checkbox"/> 200 bits/sec. <input type="checkbox"/> 300 bits/sec. <input type="checkbox"/> 600 bits/sec. <input type="checkbox"/> 1200 bits/sec.	<input type="checkbox"/> 2400 bits/sec. <input type="checkbox"/> 4800 bits/sec. <input type="checkbox"/> 9600 bits/sec.	<input type="checkbox"/> 2400 bits/sec. <input type="checkbox"/> 4800 bits/sec. <input type="checkbox"/> 9600 bits/sec. <input type="checkbox"/> 19200 bits/sec. <input type="checkbox"/> 38400 bits/sec. <input type="checkbox"/> 56000 bits/sec. <input type="checkbox"/> 64000 bits/sec.

4. LINK LAYER

Link Transmission Procedure:	Address Field of the Link:
<input type="checkbox"/> Balanced Transmission <input type="checkbox"/> Unbalanced Transmission	<input type="checkbox"/> Not Present (Balanced Transmission Only) <input type="checkbox"/> One Octet <input type="checkbox"/> Two Octets <input type="checkbox"/> Structured <input type="checkbox"/> Unstructured
Frame Length (maximum length, number of octets): Not selectable in companion IEC 60870-5-104 standard	



When using an unbalanced link layer, the following ADSU types are returned in class 2 messages (low priority) with the indicated causes of transmission:

- The standard assignment of ADSUs to class 2 messages is used as follows:
- A special assignment of ADSUs to class 2 messages is used as follows:

5. APPLICATION LAYER

Transmission Mode for Application Data:

Mode 1 (least significant octet first), as defined in Clause 4.10 of IEC 60870-5-4, is used exclusively in this companion standard.

Common Address of ADSU:

- One Octet
- Two Octets

Information Object Address:

- One Octet Structured
- Two Octets Unstructured
- Three Octets

Cause of Transmission:

- One Octet
- Two Octets (with originator address). Originator address is set to zero if not used.

Maximum Length of APDU: 253 (the maximum length may be reduced by the system).

Selection of standard ASDUs:

For the following lists, the boxes indicate the following: – used in standard direction; – not used; – cannot be selected in IEC 60870-5-104 standard.

Process information in monitor direction

<input checked="" type="checkbox"/> <1> := Single-point information	M_SP_NA_1
<input type="checkbox"/> <2> := Single-point information with time tag	M_SP_TA_1
<input type="checkbox"/> <3> := Double-point information	M_DP_NA_1
<input type="checkbox"/> <4> := Double-point information with time tag	M_DP_TA_1
<input type="checkbox"/> <5> := Step position information	M_ST_NA_1
<input type="checkbox"/> <6> := Step position information with time tag	M_ST_TA_1
<input type="checkbox"/> <7> := Bitstring of 32 bits	M_BO_NA_1
<input type="checkbox"/> <8> := Bitstring of 32 bits with time tag	M_BO_TA_1
<input type="checkbox"/> <9> := Measured value, normalized value	M_ME_NA_1
<input type="checkbox"/> <10> := Measured value, normalized value with time tag	M_ME_TA_1
<input type="checkbox"/> <11> := Measured value, scaled value	M_ME_NB_1
<input type="checkbox"/> <12> := Measured value, scaled value with time tag	M_ME_TB_1
<input checked="" type="checkbox"/> <13> := Measured value, short floating point value	M_ME_NC_1
<input type="checkbox"/> <14> := Measured value, short floating point value with time tag	M_ME_TC_1
<input checked="" type="checkbox"/> <15> := Integrated totals	M_IT_NA_1
<input type="checkbox"/> <16> := Integrated totals with time tag	M_IT_TA_1
<input type="checkbox"/> <17> := Event of protection equipment with time tag	M_EP_TA_1
<input type="checkbox"/> <18> := Packed start events of protection equipment with time tag	M_EP_TB_1
<input type="checkbox"/> <19> := Packed output circuit information of protection equipment with time tag	M_EP_TC_1
<input type="checkbox"/> <20> := Packed single-point information with status change detection	M_SP_NA_1

<input type="checkbox"/> <21> := Measured value, normalized value without quantity descriptor	M_ME_ND_1
<input checked="" type="checkbox"/> <30> := Single-point information with time tag CP56Time2a	M_SP_TB_1
<input type="checkbox"/> <31> := Double-point information with time tag CP56Time2a	M_DP_TB_1
<input type="checkbox"/> <32> := Step position information with time tag CP56Time2a	M_ST_TB_1
<input type="checkbox"/> <33> := Bitstring of 32 bits with time tag CP56Time2a	M_BO_TB_1
<input type="checkbox"/> <34> := Measured value, normalized value with time tag CP56Time2a	M_ME_TD_1
<input type="checkbox"/> <35> := Measured value, scaled value with time tag CP56Time2a	M_ME_TE_1
<input type="checkbox"/> <36> := Measured value, short floating point value with time tag CP56Time2a	M_ME_TF_1
<input checked="" type="checkbox"/> <37> := Integrated totals with time tag CP56Time2a	M_IT_TB_1
<input type="checkbox"/> <38> := Event of protection equipment with time tag CP56Time2a	M_EP_TD_1
<input type="checkbox"/> <39> := Packed start events of protection equipment with time tag CP56Time2a	M_EP_TE_1
<input type="checkbox"/> <40> := Packed output circuit information of protection equipment with time tag CP56Time2a	M_EP_TF_1

Either the ASDUs of the set <2>, <4>, <6>, <8>, <10>, <12>, <14>, <16>, <17>, <18>, and <19> or of the set <30> to <40> are used.

Process information in control direction

<input checked="" type="checkbox"/> <45> := Single command	C_SC_NA_1
<input type="checkbox"/> <46> := Double command	C_DC_NA_1
<input type="checkbox"/> <47> := Regulating step command	C_RC_NA_1
<input type="checkbox"/> <48> := Set point command, normalized value	C_SE_NA_1
<input type="checkbox"/> <49> := Set point command, scaled value	C_SE_NB_1
<input type="checkbox"/> <50> := Set point command, short floating point value	C_SE_NC_1
<input type="checkbox"/> <51> := Bitstring of 32 bits	C_BO_NA_1
<input checked="" type="checkbox"/> <58> := Single command with time tag CP56Time2a	C_SC_TA_1
<input type="checkbox"/> <59> := Double command with time tag CP56Time2a	C_DC_TA_1
<input type="checkbox"/> <60> := Regulating step command with time tag CP56Time2a	C_RC_TA_1
<input type="checkbox"/> <61> := Set point command, normalized value with time tag CP56Time2a	C_SE_TA_1
<input type="checkbox"/> <62> := Set point command, scaled value with time tag CP56Time2a	C_SE_TB_1
<input type="checkbox"/> <63> := Set point command, short floating point value with time tag CP56Time2a	C_SE_TC_1
<input type="checkbox"/> <64> := Bitstring of 32 bits with time tag CP56Time2a	C_BO_TA_1

Either the ASDUs of the set <45> to <51> or of the set <58> to <64> are used.

System information in monitor direction

<input checked="" type="checkbox"/> <70> := End of initialization	M_EI_NA_1
---	-----------

System information in control direction

<input checked="" type="checkbox"/> <100> := Interrogation command	C_IC_NA_1
<input checked="" type="checkbox"/> <101> := Counter interrogation command	C_CI_NA_1
<input checked="" type="checkbox"/> <102> := Read command	C_RD_NA_1
<input checked="" type="checkbox"/> <103> := Clock synchronization command (see Clause 7.6 in standard)	C_CS_NA_1
<input checked="" type="checkbox"/> <104> := Test command	C_TS_NA_1
<input checked="" type="checkbox"/> <105> := Reset process command	C_RP_NA_1
<input checked="" type="checkbox"/> <106> := Delay acquisition command	C_CD_NA_1
<input checked="" type="checkbox"/> <107> := Test command with time tag CP56Time2a	C_TS_TA_1

Parameter in control direction

- <110> := Parameter of measured value, normalized value PE_ME_NA_1
- <111> := Parameter of measured value, scaled value PE_ME_NB_1
- <112> := Parameter of measured value, short floating point value PE_ME_NC_1
- <113> := Parameter activation PE_AC_NA_1

File transfer

- <120> := File Ready F_FR_NA_1
- <121> := Section Ready F_SR_NA_1
- <122> := Call directory, select file, call file, call section F_SC_NA_1
- <123> := Last section, last segment F_LS_NA_1
- <124> := Ack file, ack section F_AF_NA_1
- <125> := Segment F_SG_NA_1
- <126> := Directory (blank or X, available only in monitor [standard] direction) C_CD_NA_1

Type identifier and cause of transmission assignments
(station-specific parameters)

In the following table:

- Shaded boxes are not required.
- Black boxes are not permitted in this companion standard.
- Blank boxes indicate functions or ASDU not used.
- 'X' if only used in the standard direction

TYPE IDENTIFICATION		CAUSE OF TRANSMISSION																		
		PERIODIC, CYCLIC	BACKGROUND SCAN	SPONTANEOUS	INITIALIZED	REQUEST OR REQUESTED	ACTIVATION	ACTIVATION CONFIRMATION	DEACTIVATION	DEACTIVATION CONFIRMATION	ACTIVATION TERMINATION	RETURN INFO CAUSED BY LOCAL CMD	FILE TRANSFER	INTERROGATED BY GROUP <NUMBER>	REQUEST BY GROUP <N> COUNTER REQ	UNKNOWN TYPE IDENTIFICATION	UNKNOWN CAUSE OF TRANSMISSION	UNKNOWN COMMON ADDRESS OF ADSU	UNKNOWN INFORMATION OBJECT ADDR	UNKNOWN INFORMATION OBJECT ADDR
NO.	MNEMONIC	1	2	3	4	5	6	7	8	9	10	11	12	13	20 to 36	37 to 41	44	45	46	47
<1>	M_SP_NA_1			X		X						X	X		X					
<2>	M_SP_TA_1																			
<3>	M_DP_NA_1																			
<4>	M_DP_TA_1																			
<5>	M_ST_NA_1																			
<6>	M_ST_TA_1																			
<7>	M_BO_NA_1																			
<8>	M_BO_TA_1																			

TYPE IDENTIFICATION		CAUSE OF TRANSMISSION																			
		PERIODIC, CYCLIC	BACKGROUND SCAN	SPONTANEOUS	INITIALIZED	REQUEST OR REQUESTED	ACTIVATION	ACTIVATION CONFIRMATION	DEACTIVATION	DEACTIVATION CONFIRMATION	ACTIVATION TERMINATION	RETURN INFO CAUSED BY LOCAL CMD	FILE TRANSFER	INTERROGATED BY GROUP <NUMBER>	REQUEST BY GROUP <N> COUNTER REQ	UNKNOWN TYPE IDENTIFICATION	UNKNOWN CAUSE OF TRANSMISSION	UNKNOWN COMMON ADDRESS OF ADSU	UNKNOWN INFORMATION OBJECT ADDR	UNKNOWN INFORMATION OBJECT ADDR	
NO.	MNEMONIC	1	2	3	4	5	6	7	8	9	10	11	12	13	20 to 36	37 to 41	44	45	46	47	
<9>	M_ME_NA_1																				
<10>	M_ME_TA_1																				
<11>	M_ME_NB_1																				
<12>	M_ME_TB_1																				
<13>	M_ME_NC_1	X		X		X									X						
<14>	M_ME_TC_1																				
<15>	M_IT_NA_1			X													X				
<16>	M_IT_TA_1																				
<17>	M_EP_TA_1																				
<18>	M_EP_TB_1																				
<19>	M_EP_TC_1																				
<20>	M_PS_NA_1																				
<21>	M_ME_ND_1																				
<30>	M_SP_TB_1			X								X	X								
<31>	M_DP_TB_1																				
<32>	M_ST_TB_1																				
<33>	M_BO_TB_1																				
<34>	M_ME_TD_1																				
<35>	M_ME_TE_1																				
<36>	M_ME_TF_1																				
<37>	M_IT_TB_1			X													X				
<38>	M_EP_TD_1																				
<39>	M_EP_TE_1																				
<40>	M_EP_TF_1																				
<45>	C_SC_NA_1						X	X	X	X	X										
<46>	C_DC_NA_1																				
<47>	C_RC_NA_1																				
<48>	C_SE_NA_1																				
<49>	C_SE_NB_1																				





TYPE IDENTIFICATION		CAUSE OF TRANSMISSION																			
		PERIODIC, CYCLIC	BACKGROUND SCAN	SPONTANEOUS	INITIALIZED	REQUEST OR REQUESTED	ACTIVATION	ACTIVATION CONFIRMATION	DEACTIVATION	DEACTIVATION CONFIRMATION	ACTIVATION TERMINATION	RETURN INFO CAUSED BY LOCAL CMD	FILE TRANSFER	INTERROGATED BY GROUP <NUMBER>	REQUEST BY GROUP <N> COUNTER REQ	UNKNOWN TYPE IDENTIFICATION	UNKNOWN CAUSE OF TRANSMISSION	UNKNOWN COMMON ADDRESS OF ADSU	UNKNOWN INFORMATION OBJECT ADDR	UNKNOWN INFORMATION OBJECT ADDR	
NO.	MNEMONIC	1	2	3	4	5	6	7	8	9	10	11	12	13	20 to 36	37 to 44	44	45	46	47	
<50>	C_SE_NC_1																				
<51>	C_BO_NA_1																				
<58>	C_SC_TA_1						X	X	X	X	X										
<59>	C_DC_TA_1																				
<60>	C_RC_TA_1																				
<61>	C_SE_TA_1																				
<62>	C_SE_TB_1																				
<63>	C_SE_TC_1																				
<64>	C_BO_TA_1																				
<70>	M_EI_NA_1*)				X																
<100>	C_IC_NA_1						X	X	X	X	X										
<101>	C_CI_NA_1						X	X			X										
<102>	C_RD_NA_1					X															
<103>	C_CS_NA_1			X			X	X													
<104>	C_TS_NA_1																				
<105>	C_RP_NA_1						X	X													
<106>	C_CD_NA_1																				
<107>	C_TS_TA_1																				
<110>	P_ME_NA_1																				
<111>	P_ME_NB_1																				
<112>	P_ME_NC_1						X	X								X					
<113>	P_AC_NA_1																				
<120>	F_FR_NA_1																				
<121>	F_SR_NA_1																				
<122>	F_SC_NA_1																				
<123>	F_LS_NA_1																				
<124>	F_AF_NA_1																				
<125>	F_SG_NA_1																				
<126>	F_DR_TA_1*)																				

6. BASIC APPLICATION FUNCTIONS

Station Initialization:

- Remote initialization

Cyclic Data Transmission:

- Cyclic data transmission

Read Procedure:

- Read procedure

Spontaneous Transmission:

- Spontaneous transmission

Double transmission of information objects with cause of transmission spontaneous:

The following type identifications may be transmitted in succession caused by a single status change of an information object. The particular information object addresses for which double transmission is enabled are defined in a project-specific list.

- Single point information: M_SP_NA_1, M_SP_TA_1, M_SP_TB_1, and M_PS_NA_1
- Double point information: M_DP_NA_1, M_DP_TA_1, and M_DP_TB_1
- Step position information: M_ST_NA_1, M_ST_TA_1, and M_ST_TB_1
- Bitstring of 32 bits: M_BO_NA_1, M_BO_TA_1, and M_BO_TB_1 (if defined for a specific project)
- Measured value, normalized value: M_ME_NA_1, M_ME_TA_1, M_ME_ND_1, and M_ME_TD_1
- Measured value, scaled value: M_ME_NB_1, M_ME_TB_1, and M_ME_TE_1
- Measured value, short floating point number: M_ME_NC_1, M_ME_TC_1, and M_ME_TF_1

Station interrogation:

- Global
- Group 1
- Group 2
- Group 3
- Group 4
- Group 5
- Group 6
- Group 7
- Group 8
- Group 9
- Group 10
- Group 11
- Group 12
- Group 13
- Group 14
- Group 15
- Group 16

Clock synchronization:

- Clock synchronization (optional, see Clause 7.6)

Command transmission:

- Direct command transmission
- Direct setpoint command transmission
- Select and execute command
- Select and execute setpoint command
- C_SE ACTTERM used
- No additional definition
- Short pulse duration (duration determined by a system parameter in the outstation)
- Long pulse duration (duration determined by a system parameter in the outstation)
- Persistent output

- Supervision of maximum delay in command direction of commands and setpoint commands

Maximum allowable delay of commands and setpoint commands: **10 s**

Transmission of integrated totals:

- Mode A: Local freeze with spontaneous transmission
- Mode B: Local freeze with counter interrogation
- Mode C: Freeze and transmit by counter-interrogation commands
- Mode D: Freeze by counter-interrogation command, frozen values reported simultaneously

- Counter read
- Counter freeze without reset
- Counter freeze with reset
- Counter reset

- General request counter
- Request counter group 1
- Request counter group 2
- Request counter group 3
- Request counter group 4

Parameter loading:

- Threshold value
- Smoothing factor
- Low limit for transmission of measured values
- High limit for transmission of measured values

Parameter activation:

- Activation/deactivation of persistent cyclic or periodic transmission of the addressed object

Test procedure:

- Test procedure

File transfer:

File transfer in monitor direction:

- Transparent file
- Transmission of disturbance data of protection equipment
- Transmission of sequences of events
- Transmission of sequences of recorded analog values

File transfer in control direction:

- Transparent file

Background scan:

- Background scan

Acquisition of transmission delay:

- Acquisition of transmission delay

Definition of time outs:

PARAMETER	DEFAULT VALUE	REMARKS	SELECTED VALUE
t_0	30 s	Timeout of connection establishment	120 s
t_1	15 s	Timeout of send or test APDUs	15 s
t_2	10 s	Timeout for acknowledgements in case of no data messages $t_2 < t_1$	10 s
t_3	20 s	Timeout for sending test frames in case of a long idle state	20 s

Maximum range of values for all time outs: 1 to 255 s, accuracy 1 s

Maximum number of outstanding I-format APDUs k and latest acknowledge APDUs (w):

PARAMETER	DEFAULT VALUE	REMARKS	SELECTED VALUE
k	12 APDUs	Maximum difference receive sequence number to send state variable	12 APDUs
w	8 APDUs	Latest acknowledge after receiving w I-format APDUs	8 APDUs

Maximum range of values k : 1 to 32767 ($2^{15} - 1$) APDUs, accuracy 1 APDU

Maximum range of values w : 1 to 32767 APDUs, accuracy 1 APDU

Recommendation: w should not exceed two-thirds of k .

Portnumber:

PARAMETER	VALUE	REMARKS
Portnumber	2404	In all cases

RFC 2200 suite:

RFC 2200 is an official Internet Standard which describes the state of standardization of protocols used in the Internet as determined by the Internet Architecture Board (IAB). It offers a broad spectrum of actual standards used in the Internet. The suitable selection of documents from RFC 2200 defined in this standard for given projects has to be chosen by the user of this standard.

- Ethernet 802.3
- Serial X.21 interface
- Other selection(s) from RFC 2200 (list below if selected)

C.1.2 POINTS LIST

Only Source 1 data points are shown in the following table. If the **NUMBER OF SOURCES IN MMENC LIST** setting is increased, data points for subsequent sources will be added to the list immediately following the Source 1 data points.

Table C–1: IEC 60870-5-104 POINTS (Sheet 1 of 7)

POINT	DESCRIPTION	UNITS
M_ME_NC_1 Points		
2000	SRC 1 Phase A Current RMS	A
2001	SRC 1 Phase B Current RMS	A
2002	SRC 1 Phase C Current RMS	A
2003	SRC 1 Neutral Current RMS	A
2004	SRC 1 Phase A Current Magnitude	A
2005	SRC 1 Phase A Current Angle	degrees
2006	SRC 1 Phase B Current Magnitude	A
2007	SRC 1 Phase B Current Angle	degrees
2008	SRC 1 Phase C Current Magnitude	A
2009	SRC 1 Phase C Current Angle	degrees
2010	SRC 1 Neutral Current Magnitude	A
2011	SRC 1 Neutral Current Angle	degrees
2012	SRC 1 Ground Current RMS	A
2013	SRC 1 Ground Current Magnitude	A
2014	SRC 1 Ground Current Angle	degrees
2015	SRC 1 Zero Sequence Current Magnitude	A
2016	SRC 1 Zero Sequence Current Angle	degrees
2017	SRC 1 Positive Sequence Current Magnitude	A
2018	SRC 1 Positive Sequence Current Angle	degrees
2019	SRC 1 Negative Sequence Current Magnitude	A
2020	SRC 1 Negative Sequence Current Angle	degrees
2021	SRC 1 Differential Ground Current Magnitude	A
2022	SRC 1 Differential Ground Current Angle	degrees
2023	SRC 1 Phase AG Voltage RMS	V
2024	SRC 1 Phase BG Voltage RMS	V
2025	SRC 1 Phase CG Voltage RMS	V
2026	SRC 1 Phase AG Voltage Magnitude	V
2027	SRC 1 Phase AG Voltage Angle	degrees
2028	SRC 1 Phase BG Voltage Magnitude	V
2029	SRC 1 Phase BG Voltage Angle	degrees
2030	SRC 1 Phase CG Voltage Magnitude	V
2031	SRC 1 Phase CG Voltage Angle	degrees
2032	SRC 1 Phase AB Voltage RMS	V
2033	SRC 1 Phase BC Voltage RMS	V
2034	SRC 1 Phase CA Voltage RMS	V
2035	SRC 1 Phase AB Voltage Magnitude	V
2036	SRC 1 Phase AB Voltage Angle	degrees
2037	SRC 1 Phase BC Voltage Magnitude	V
2038	SRC 1 Phase BC Voltage Angle	degrees
2039	SRC 1 Phase CA Voltage Magnitude	V
2040	SRC 1 Phase CA Voltage Angle	degrees
2041	SRC 1 Auxiliary Voltage RMS	V
2042	SRC 1 Auxiliary Voltage Magnitude	V
2043	SRC 1 Auxiliary Voltage Angle	degrees
2044	SRC 1 Zero Sequence Voltage Magnitude	V

Table C–1: IEC 60870-5-104 POINTS (Sheet 2 of 7)

POINT	DESCRIPTION	UNITS
2045	SRC 1 Zero Sequence Voltage Angle	degrees
2046	SRC 1 Positive Sequence Voltage Magnitude	V
2047	SRC 1 Positive Sequence Voltage Angle	degrees
2048	SRC 1 Negative Sequence Voltage Magnitude	V
2049	SRC 1 Negative Sequence Voltage Angle	degrees
2050	SRC 1 Three Phase Real Power	W
2051	SRC 1 Phase A Real Power	W
2052	SRC 1 Phase B Real Power	W
2053	SRC 1 Phase C Real Power	W
2054	SRC 1 Three Phase Reactive Power	var
2055	SRC 1 Phase A Reactive Power	var
2056	SRC 1 Phase B Reactive Power	var
2057	SRC 1 Phase C Reactive Power	var
2058	SRC 1 Three Phase Apparent Power	VA
2059	SRC 1 Phase A Apparent Power	VA
2060	SRC 1 Phase B Apparent Power	VA
2061	SRC 1 Phase C Apparent Power	VA
2062	SRC 1 Three Phase Power Factor	none
2063	SRC 1 Phase A Power Factor	none
2064	SRC 1 Phase B Power Factor	none
2065	SRC 1 Phase C Power Factor	none
2066	SRC 1 Positive Watthour	Wh
2067	SRC 1 Negative Watthour	Wh
2068	SRC 1 Positive Varhour	varh
2069	SRC 1 Negative Varhour	varh
2070	SRC 1 Frequency	Hz
2071	SRC 1 Demand Ia	A
2072	SRC 1 Demand Ib	A
2073	SRC 1 Demand Ic	A
2074	SRC 1 Demand Watt	W
2075	SRC 1 Demand Var	var
2076	SRC 1 Demand Va	VA
2077	SRC 1 Va THD	none
2078	SRC 1 Va Harmonics[0]	none
2079	SRC 1 Va Harmonics[1]	none
2080	SRC 1 Va Harmonics[2]	none
2081	SRC 1 Va Harmonics[3]	none
2082	SRC 1 Va Harmonics[4]	none
2083	SRC 1 Va Harmonics[5]	none
2084	SRC 1 Va Harmonics[6]	none
2085	SRC 1 Va Harmonics[7]	none
2086	SRC 1 Va Harmonics[8]	none
2087	SRC 1 Va Harmonics[9]	none
2088	SRC 1 Va Harmonics[10]	none
2089	SRC 1 Va Harmonics[11]	none
2090	SRC 1 Va Harmonics[12]	none

Table C-1: IEC 60870-5-104 POINTS (Sheet 3 of 7)

POINT	DESCRIPTION	UNITS
2091	SRC 1 Va Harmonics[13]	none
2092	SRC 1 Va Harmonics[14]	none
2093	SRC 1 Va Harmonics[15]	none
2094	SRC 1 Va Harmonics[16]	none
2095	SRC 1 Va Harmonics[17]	none
2096	SRC 1 Va Harmonics[18]	none
2097	SRC 1 Va Harmonics[19]	none
2098	SRC 1 Va Harmonics[20]	none
2099	SRC 1 Va Harmonics[21]	none
2100	SRC 1 Va Harmonics[22]	none
2101	SRC 1 Va Harmonics[23]	none
2102	SRC 1 Vb THD	none
2103	SRC 1 Vb Harmonics[0]	none
2104	SRC 1 Vb Harmonics[1]	none
2105	SRC 1 Vb Harmonics[2]	none
2106	SRC 1 Vb Harmonics[3]	none
2107	SRC 1 Vb Harmonics[4]	none
2108	SRC 1 Vb Harmonics[5]	none
2109	SRC 1 Vb Harmonics[6]	none
2110	SRC 1 Vb Harmonics[7]	none
2111	SRC 1 Vb Harmonics[8]	none
2112	SRC 1 Vb Harmonics[9]	none
2113	SRC 1 Vb Harmonics[10]	none
2114	SRC 1 Vb Harmonics[11]	none
2115	SRC 1 Vb Harmonics[12]	none
2116	SRC 1 Vb Harmonics[13]	none
2117	SRC 1 Vb Harmonics[14]	none
2118	SRC 1 Vb Harmonics[15]	none
2119	SRC 1 Vb Harmonics[16]	none
2120	SRC 1 Vb Harmonics[17]	none
2121	SRC 1 Vb Harmonics[18]	none
2122	SRC 1 Vb Harmonics[19]	none
2123	SRC 1 Vb Harmonics[20]	none
2124	SRC 1 Vb Harmonics[21]	none
2125	SRC 1 Vb Harmonics[22]	none
2126	SRC 1 Vb Harmonics[23]	none
2127	SRC 1 Vc THD	none
2128	SRC 1 Vc Harmonics[0]	none
2129	SRC 1 Vc Harmonics[1]	none
2130	SRC 1 Vc Harmonics[2]	none
2131	SRC 1 Vc Harmonics[3]	none
2132	SRC 1 Vc Harmonics[4]	none
2133	SRC 1 Vc Harmonics[5]	none
2134	SRC 1 Vc Harmonics[6]	none
2135	SRC 1 Vc Harmonics[7]	none
2136	SRC 1 Vc Harmonics[8]	none
2137	SRC 1 Vc Harmonics[9]	none
2138	SRC 1 Vc Harmonics[10]	none
2139	SRC 1 Vc Harmonics[11]	none
2140	SRC 1 Vc Harmonics[12]	none
2141	SRC 1 Vc Harmonics[13]	none
2142	SRC 1 Vc Harmonics[14]	none

Table C-1: IEC 60870-5-104 POINTS (Sheet 4 of 7)

POINT	DESCRIPTION	UNITS
2143	SRC 1 Vc Harmonics[15]	none
2144	SRC 1 Vc Harmonics[16]	none
2145	SRC 1 Vc Harmonics[17]	none
2146	SRC 1 Vc Harmonics[18]	none
2147	SRC 1 Vc Harmonics[19]	none
2148	SRC 1 Vc Harmonics[20]	none
2149	SRC 1 Vc Harmonics[21]	none
2150	SRC 1 Vc Harmonics[22]	none
2151	SRC 1 Vc Harmonics[23]	none
2152	Fault 1 Prefault Phase A Current Magnitude	A
2153	Fault 1 Prefault Phase A Current Angle	degrees
2154	Fault 1 Prefault Phase B Current Magnitude	A
2155	Fault 1 Prefault Phase B Current Angle	degrees
2156	Fault 1 Prefault Phase C Current Magnitude	A
2157	Fault 1 Prefault Phase C Current Angle	degrees
2158	Fault 1 Prefault Phase A Voltage Magnitude	V
2159	Fault 1 Prefault Phase A Voltage Angle	degrees
2160	Fault 1 Prefault Phase B Voltage Magnitude	V
2161	Fault 1 Prefault Phase B Voltage Angle	degrees
2162	Fault 1 Prefault Phase C Voltage Magnitude	V
2163	Fault 1 Prefault Phase C Voltage Angle	degrees
2164	Fault 1 Postfault Phase A Current Magnitude	A
2165	Fault 1 Postfault Phase A Current Angle	degrees
2166	Fault 1 Postfault Phase B Current Magnitude	A
2167	Fault 1 Postfault Phase B Current Angle	degrees
2168	Fault 1 Postfault Phase C Current Magnitude	A
2169	Fault 1 Postfault Phase C Current Angle	degrees
2170	Fault 1 Postfault Phase A Voltage Magnitude	V
2171	Fault 1 Postfault Phase A Voltage Angle	degrees
2172	Fault 1 Postfault Phase B Voltage Magnitude	V
2173	Fault 1 Postfault Phase B Voltage Angle	degrees
2174	Fault 1 Postfault Phase C Voltage Magnitude	V
2175	Fault 1 Postfault Phase C Voltage Angle	degrees
2176	Fault 1 Type	none
2177	Fault 1 Location	none
2178	Fault 2 Prefault Phase A Current Magnitude	A
2179	Fault 2 Prefault Phase A Current Angle	degrees
2180	Fault 2 Prefault Phase B Current Magnitude	A
2181	Fault 2 Prefault Phase B Current Angle	degrees
2182	Fault 2 Prefault Phase C Current Magnitude	A
2183	Fault 2 Prefault Phase C Current Angle	degrees
2184	Fault 2 Prefault Phase A Voltage Magnitude	V
2185	Fault 2 Prefault Phase A Voltage Angle	degrees
2186	Fault 2 Prefault Phase B Voltage Magnitude	V
2187	Fault 2 Prefault Phase B Voltage Angle	degrees
2188	Fault 2 Prefault Phase C Voltage Magnitude	V
2189	Fault 2 Prefault Phase C Voltage Angle	degrees
2190	Fault 2 Postfault Phase A Current Magnitude	A
2191	Fault 2 Postfault Phase A Current Angle	degrees
2192	Fault 2 Postfault Phase B Current Magnitude	A
2193	Fault 2 Postfault Phase B Current Angle	degrees
2194	Fault 2 Postfault Phase C Current Magnitude	A

Table C-1: IEC 60870-5-104 POINTS (Sheet 5 of 7)

POINT	DESCRIPTION	UNITS
2195	Fault 2 Postfault Phase C Current Angle	degrees
2196	Fault 2 Postfault Phase A Voltage Magnitude	V
2197	Fault 2 Postfault Phase A Voltage Angle	degrees
2198	Fault 2 Postfault Phase B Voltage Magnitude	V
2199	Fault 2 Postfault Phase B Voltage Angle	degrees
2200	Fault 2 Postfault Phase C Voltage Magnitude	V
2201	Fault 2 Postfault Phase C Voltage Angle	degrees
2202	Fault 2 Type	none
2203	Fault 2 Location	none
2204	Fault 3 Prefault Phase A Current Magnitude	A
2205	Fault 3 Prefault Phase A Current Angle	degrees
2206	Fault 3 Prefault Phase B Current Magnitude	A
2207	Fault 3 Prefault Phase B Current Angle	degrees
2208	Fault 3 Prefault Phase C Current Magnitude	A
2209	Fault 3 Prefault Phase C Current Angle	degrees
2210	Fault 3 Prefault Phase A Voltage Magnitude	V
2211	Fault 3 Prefault Phase A Voltage Angle	degrees
2212	Fault 3 Prefault Phase B Voltage Magnitude	V
2213	Fault 3 Prefault Phase B Voltage Angle	degrees
2214	Fault 3 Prefault Phase C Voltage Magnitude	V
2215	Fault 3 Prefault Phase C Voltage Angle	degrees
2216	Fault 3 Postfault Phase A Current Magnitude	A
2217	Fault 3 Postfault Phase A Current Angle	degrees
2218	Fault 3 Postfault Phase B Current Magnitude	A
2219	Fault 3 Postfault Phase B Current Angle	degrees
2220	Fault 3 Postfault Phase C Current Magnitude	A
2221	Fault 3 Postfault Phase C Current Angle	degrees
2222	Fault 3 Postfault Phase A Voltage Magnitude	V
2223	Fault 3 Postfault Phase A Voltage Angle	degrees
2224	Fault 3 Postfault Phase B Voltage Magnitude	V
2225	Fault 3 Postfault Phase B Voltage Angle	degrees
2226	Fault 3 Postfault Phase C Voltage Magnitude	V
2227	Fault 3 Postfault Phase C Voltage Angle	degrees
2228	Fault 3 Type	none
2229	Fault 3 Location	none
2230	Fault 4 Prefault Phase A Current Magnitude	A
2231	Fault 4 Prefault Phase A Current Angle	degrees
2232	Fault 4 Prefault Phase B Current Magnitude	A
2233	Fault 4 Prefault Phase B Current Angle	degrees
2234	Fault 4 Prefault Phase C Current Magnitude	A
2235	Fault 4 Prefault Phase C Current Angle	degrees
2236	Fault 4 Prefault Phase A Voltage Magnitude	V
2237	Fault 4 Prefault Phase A Voltage Angle	degrees
2238	Fault 4 Prefault Phase B Voltage Magnitude	V
2239	Fault 4 Prefault Phase B Voltage Angle	degrees
2240	Fault 4 Prefault Phase C Voltage Magnitude	V
2241	Fault 4 Prefault Phase C Voltage Angle	degrees
2242	Fault 4 Postfault Phase A Current Magnitude	A
2243	Fault 4 Postfault Phase A Current Angle	degrees
2244	Fault 4 Postfault Phase B Current Magnitude	A
2245	Fault 4 Postfault Phase B Current Angle	degrees
2246	Fault 4 Postfault Phase C Current Magnitude	A

Table C-1: IEC 60870-5-104 POINTS (Sheet 6 of 7)

POINT	DESCRIPTION	UNITS
2247	Fault 4 Postfault Phase C Current Angle	degrees
2248	Fault 4 Postfault Phase A Voltage Magnitude	V
2249	Fault 4 Postfault Phase A Voltage Angle	degrees
2250	Fault 4 Postfault Phase B Voltage Magnitude	V
2251	Fault 4 Postfault Phase B Voltage Angle	degrees
2252	Fault 4 Postfault Phase C Voltage Magnitude	V
2253	Fault 4 Postfault Phase C Voltage Angle	degrees
2254	Fault 4 Type	none
2255	Fault 4 Location	none
2256	Fault 5 Prefault Phase A Current Magnitude	A
2257	Fault 5 Prefault Phase A Current Angle	degrees
2258	Fault 5 Prefault Phase B Current Magnitude	A
2259	Fault 5 Prefault Phase B Current Angle	degrees
2260	Fault 5 Prefault Phase C Current Magnitude	A
2261	Fault 5 Prefault Phase C Current Angle	degrees
2262	Fault 5 Prefault Phase A Voltage Magnitude	V
2263	Fault 5 Prefault Phase A Voltage Angle	degrees
2264	Fault 5 Prefault Phase B Voltage Magnitude	V
2265	Fault 5 Prefault Phase B Voltage Angle	degrees
2266	Fault 5 Prefault Phase C Voltage Magnitude	V
2267	Fault 5 Prefault Phase C Voltage Angle	degrees
2268	Fault 5 Postfault Phase A Current Magnitude	A
2269	Fault 5 Postfault Phase A Current Angle	degrees
2270	Fault 5 Postfault Phase B Current Magnitude	A
2271	Fault 5 Postfault Phase B Current Angle	degrees
2272	Fault 5 Postfault Phase C Current Magnitude	A
2273	Fault 5 Postfault Phase C Current Angle	degrees
2274	Fault 5 Postfault Phase A Voltage Magnitude	V
2275	Fault 5 Postfault Phase A Voltage Angle	degrees
2276	Fault 5 Postfault Phase B Voltage Magnitude	V
2277	Fault 5 Postfault Phase B Voltage Angle	degrees
2278	Fault 5 Postfault Phase C Voltage Magnitude	V
2279	Fault 5 Postfault Phase C Voltage Angle	degrees
2280	Fault 5 Type	none
2281	Fault 5 Location	none
2282	DCMA Inputs 1 Value	none
2283	DCMA Inputs 2 Value	none
2284	DCMA Inputs 3 Value	none
2285	DCMA Inputs 4 Value	none
2286	RTD Inputs 1 Value	degreesC
2287	RTD Inputs 2 Value	degreesC
2288	RTD Inputs 3 Value	degreesC
2289	RTD Inputs 4 Value	degreesC
2290	Tracking Frequency	Hz
2291	FlexElement 1 Actual	none
2292	FlexElement 2 Actual	none
2293	FlexElement 3 Actual	none
2294	FlexElement 4 Actual	none
2295	FlexElement 5 Actual	none
2296	FlexElement 6 Actual	none
2297	FlexElement 7 Actual	none
2298	FlexElement 8 Actual	none

Table C-1: IEC 60870-5-104 POINTS (Sheet 7 of 7)

POINT	DESCRIPTION	UNITS
2299	FlexElement 9 Actual	none
2300	FlexElement 10 Actual	none
2301	FlexElement 11 Actual	none
2302	FlexElement 12 Actual	none
2303	FlexElement 13 Actual	none
2304	FlexElement 14 Actual	none
2305	FlexElement 15 Actual	none
2306	FlexElement 16 Actual	none
2307	Current Setting Group	none
P_ME_NC_1 Points		
5000 - 5306	Threshold values for M_ME_NC_1 points	-
M_IT_NA_1 Points		
4000	Digital Counter 1 Value	-
4001	Digital Counter 2 Value	-
4002	Digital Counter 3 Value	-
4003	Digital Counter 4 Value	-
4004	Digital Counter 5 Value	-
4005	Digital Counter 6 Value	-
4006	Digital Counter 7 Value	-
4007	Digital Counter 8 Value	-
M_SP_NA_1 Points		
100 - 115	Virtual Input States[0]	-
116 - 131	Virtual Input States[1]	-
132 - 147	Virtual Output States[0]	-
148 - 163	Virtual Output States[1]	-
164 - 179	Virtual Output States[2]	-
180 - 195	Virtual Output States[3]	-
196 - 211	Contact Input States[0]	-
212 - 227	Contact Input States[1]	-
228 - 243	Contact Input States[2]	-
244 - 259	Contact Input States[3]	-
260 - 275	Contact Input States[4]	-
276 - 291	Contact Input States[5]	-
292 - 307	Contact Output States[0]	-
308 - 323	Contact Output States[1]	-
324 - 339	Contact Output States[2]	-
340 - 355	Contact Output States[3]	-
356 - 371	Remote Input 1 States[0]	-
372 - 387	Remote Input 1 States[1]	-
388 - 403	Remote Device 1 States	-
404 - 419	LED Column 1 State[0]	-
420 - 435	LED Column 1 State[1]	-
C_SC_NA_1 Points		
1100 - 1115	Virtual Input States[0] - No Select Required	-
1116 - 1131	Virtual Input States[1] - Select Required	-

C

D.1.1 DEVICE PROFILE DOCUMENT

The following table provides a 'Device Profile Document' in the standard format defined in the DNP 3.0 Subset Definitions Document.

Table D-1: DNP V3.00 DEVICE PROFILE (Sheet 1 of 3)

(Also see the IMPLEMENTATION TABLE in the following section)	
Vendor Name: General Electric Multilin	
Device Name: UR Series Relay	
Highest DNP Level Supported: For Requests: Level 2 For Responses: Level 2	Device Function: <input type="checkbox"/> Master <input checked="" type="checkbox"/> Slave
Notable objects, functions, and/or qualifiers supported in addition to the Highest DNP Levels Supported (the complete list is described in the attached table): Binary Inputs (Object 1) Binary Input Changes (Object 2) Binary Outputs (Object 10) Binary Counters (Object 20) Frozen Counters (Object 21) Counter Change Event (Object 22) Frozen Counter Event (Object 23) Analog Inputs (Object 30) Analog Input Changes (Object 32) Analog Deadbands (Object 34)	
Maximum Data Link Frame Size (octets): Transmitted: 292 Received: 292	Maximum Application Fragment Size (octets): Transmitted: 240 Received: 2048
Maximum Data Link Re-tries: <input type="checkbox"/> None <input checked="" type="checkbox"/> Fixed at 2 <input type="checkbox"/> Configurable	Maximum Application Layer Re-tries: <input checked="" type="checkbox"/> None <input type="checkbox"/> Configurable
Requires Data Link Layer Confirmation: <input checked="" type="checkbox"/> Never <input type="checkbox"/> Always <input type="checkbox"/> Sometimes <input type="checkbox"/> Configurable	

Table D-1: DNP V3.00 DEVICE PROFILE (Sheet 2 of 3)

Requires Application Layer Confirmation:				
<input type="checkbox"/>	Never			
<input type="checkbox"/>	Always			
<input checked="" type="checkbox"/>	When reporting Event Data			
<input checked="" type="checkbox"/>	When sending multi-fragment responses			
<input type="checkbox"/>	Sometimes			
<input type="checkbox"/>	Configurable			
Timeouts while waiting for:				
Data Link Confirm:	<input type="checkbox"/> None	<input checked="" type="checkbox"/> Fixed at 3 s	<input type="checkbox"/> Variable	<input type="checkbox"/> Configurable
Complete Appl. Fragment:	<input checked="" type="checkbox"/> None	<input type="checkbox"/> Fixed at ____	<input type="checkbox"/> Variable	<input type="checkbox"/> Configurable
Application Confirm:	<input type="checkbox"/> None	<input checked="" type="checkbox"/> Fixed at 4 s	<input type="checkbox"/> Variable	<input type="checkbox"/> Configurable
Complete Appl. Response:	<input checked="" type="checkbox"/> None	<input type="checkbox"/> Fixed at ____	<input type="checkbox"/> Variable	<input type="checkbox"/> Configurable
Others:				
Transmission Delay:	No intentional delay			
Inter-character Timeout:	50 ms			
Need Time Delay:	Configurable (default = 24 hrs.)			
Select/Operate Arm Timeout:	10 s			
Binary input change scanning period:	8 times per power system cycle			
Packed binary change process period:	1 s			
Analog input change scanning period:	500 ms			
Counter change scanning period:	500 ms			
Frozen counter event scanning period:	500 ms			
Unsolicited response notification delay:	500 ms			
Unsolicited response retry delay	configurable 0 to 60 sec.			
Sends/Executes Control Operations:				
WRITE Binary Outputs	<input checked="" type="checkbox"/> Never	<input type="checkbox"/> Always	<input type="checkbox"/> Sometimes	<input type="checkbox"/> Configurable
SELECT/OPERATE	<input type="checkbox"/> Never	<input checked="" type="checkbox"/> Always	<input type="checkbox"/> Sometimes	<input type="checkbox"/> Configurable
DIRECT OPERATE	<input type="checkbox"/> Never	<input checked="" type="checkbox"/> Always	<input type="checkbox"/> Sometimes	<input type="checkbox"/> Configurable
DIRECT OPERATE – NO ACK	<input type="checkbox"/> Never	<input checked="" type="checkbox"/> Always	<input type="checkbox"/> Sometimes	<input type="checkbox"/> Configurable
Count > 1	<input checked="" type="checkbox"/> Never	<input type="checkbox"/> Always	<input type="checkbox"/> Sometimes	<input type="checkbox"/> Configurable
Pulse On	<input type="checkbox"/> Never	<input type="checkbox"/> Always	<input checked="" type="checkbox"/> Sometimes	<input type="checkbox"/> Configurable
Pulse Off	<input type="checkbox"/> Never	<input type="checkbox"/> Always	<input checked="" type="checkbox"/> Sometimes	<input type="checkbox"/> Configurable
Latch On	<input type="checkbox"/> Never	<input type="checkbox"/> Always	<input checked="" type="checkbox"/> Sometimes	<input type="checkbox"/> Configurable
Latch Off	<input type="checkbox"/> Never	<input type="checkbox"/> Always	<input checked="" type="checkbox"/> Sometimes	<input type="checkbox"/> Configurable
Queue	<input checked="" type="checkbox"/> Never	<input type="checkbox"/> Always	<input type="checkbox"/> Sometimes	<input type="checkbox"/> Configurable
Clear Queue	<input checked="" type="checkbox"/> Never	<input type="checkbox"/> Always	<input type="checkbox"/> Sometimes	<input type="checkbox"/> Configurable
Explanation of ‘Sometimes’: Object 12 points are mapped to UR Virtual Inputs. The persistence of Virtual Inputs is determined by the VIRTUAL INPUT X TYPE settings. Both “Pulse On” and “Latch On” operations perform the same function in the UR; that is, the appropriate Virtual Input is put into the “On” state. If the Virtual Input is set to “Self-Reset”, it will reset after one pass of FlexLogic™. The On/Off times and Count value are ignored. “Pulse Off” and “Latch Off” operations put the appropriate Virtual Input into the “Off” state. “Trip” and “Close” operations both put the appropriate Virtual Input into the “On” state.				

Table D-1: DNP V3.00 DEVICE PROFILE (Sheet 3 of 3)

<p>Reports Binary Input Change Events when no specific variation requested:</p> <ul style="list-style-type: none"> <input type="checkbox"/> Never <input checked="" type="checkbox"/> Only time-tagged <input type="checkbox"/> Only non-time-tagged <input type="checkbox"/> Configurable 	<p>Reports time-tagged Binary Input Change Events when no specific variation requested:</p> <ul style="list-style-type: none"> <input type="checkbox"/> Never <input checked="" type="checkbox"/> Binary Input Change With Time <input type="checkbox"/> Binary Input Change With Relative Time <input type="checkbox"/> Configurable (attach explanation)
<p>Sends Unsolicited Responses:</p> <ul style="list-style-type: none"> <input type="checkbox"/> Never <input checked="" type="checkbox"/> Configurable <input type="checkbox"/> Only certain objects <input type="checkbox"/> Sometimes (attach explanation) <input checked="" type="checkbox"/> ENABLE/DISABLE unsolicited Function codes supported 	<p>Sends Static Data in Unsolicited Responses:</p> <ul style="list-style-type: none"> <input checked="" type="checkbox"/> Never <input type="checkbox"/> When Device Restarts <input type="checkbox"/> When Status Flags Change <p>No other options are permitted.</p>
<p>Default Counter Object/Variation:</p> <ul style="list-style-type: none"> <input type="checkbox"/> No Counters Reported <input type="checkbox"/> Configurable (attach explanation) <input checked="" type="checkbox"/> Default Object: 20 <input checked="" type="checkbox"/> Default Variation: 1 <input checked="" type="checkbox"/> Point-by-point list attached 	<p>Counters Roll Over at:</p> <ul style="list-style-type: none"> <input type="checkbox"/> No Counters Reported <input type="checkbox"/> Configurable (attach explanation) <input checked="" type="checkbox"/> 16 Bits (Counter 8) <input checked="" type="checkbox"/> 32 Bits (Counters 0 to 7, 9) <input type="checkbox"/> Other Value: _____ <input checked="" type="checkbox"/> Point-by-point list attached
<p>Sends Multi-Fragment Responses:</p> <ul style="list-style-type: none"> <input checked="" type="checkbox"/> Yes <input type="checkbox"/> No 	



D.1.2 IMPLEMENTATION TABLE

The following table identifies the variations, function codes, and qualifiers supported by the F35 in both request messages and in response messages. For static (non-change-event) objects, requests sent with qualifiers 00, 01, 06, 07, or 08, will be responded with qualifiers 00 or 01. Static object requests sent with qualifiers 17 or 28 will be responded with qualifiers 17 or 28. For change-event objects, qualifiers 17 or 28 are always responded.

Table D–2: IMPLEMENTATION TABLE (Sheet 1 of 4)

OBJECT			REQUEST		RESPONSE	
OBJECT NO.	VARIATION NO.	DESCRIPTION	FUNCTION CODES (DEC)	QUALIFIER CODES (HEX)	FUNCTION CODES (DEC)	QUALIFIER CODES (HEX)
1	0	Binary Input (Variation 0 is used to request default variation)	1 (read) 22 (assign class)	00, 01 (start-stop) 06 (no range, or all) 07, 08 (limited quantity) 17, 28 (index)		
	1	Binary Input	1 (read) 22 (assign class)	00, 01 (start-stop) 06 (no range, or all) 07, 08 (limited quantity) 17, 28 (index)	129 (response)	00, 01 (start-stop) 17, 28 (index) (see Note 2)
	2	Binary Input with Status	1 (read) 22 (assign class)	00, 01 (start-stop) 06 (no range, or all) 07, 08 (limited quantity) 17, 28 (index)	129 (response)	00, 01 (start-stop) 17, 28 (index) (see Note 2)
2	0	Binary Input Change (Variation 0 is used to request default variation)	1 (read)	06 (no range, or all) 07, 08 (limited quantity)		
	1	Binary Input Change without Time	1 (read)	06 (no range, or all) 07, 08 (limited quantity)	129 (response) 130 (unsol. resp.)	17, 28 (index)
	2	Binary Input Change with Time	1 (read)	06 (no range, or all) 07, 08 (limited quantity)	129 (response) 130 (unsol. resp.)	17, 28 (index)
	3 (parse only)	Binary Input Change with Relative Time	1 (read)	06 (no range, or all) 07, 08 (limited quantity)		
10	0	Binary Output Status (Variation 0 is used to request default variation)	1 (read)	00, 01 (start-stop) 06 (no range, or all) 07, 08 (limited quantity) 17, 28 (index)		
	2	Binary Output Status	1 (read)	00, 01 (start-stop) 06 (no range, or all) 07, 08 (limited quantity) 17, 28 (index)	129 (response)	00, 01 (start-stop) 17, 28 (index) (see Note 2)
12	1	Control Relay Output Block	3 (select) 4 (operate) 5 (direct op) 6 (dir. op, noack)	00, 01 (start-stop) 07, 08 (limited quantity) 17, 28 (index)	129 (response)	echo of request
20	0	Binary Counter (Variation 0 is used to request default variation)	1 (read) 7 (freeze) 8 (freeze noack) 9 (freeze clear) 10 (frz. cl. noack) 22 (assign class)	00, 01 (start-stop) 06 (no range, or all) 07, 08 (limited quantity) 17, 28 (index)		
	1	32-Bit Binary Counter	1 (read) 7 (freeze) 8 (freeze noack) 9 (freeze clear) 10 (frz. cl. noack) 22 (assign class)	00, 01 (start-stop) 06 (no range, or all) 07, 08 (limited quantity) 17, 28 (index)	129 (response)	00, 01 (start-stop) 17, 28 (index) (see Note 2)

Note 1: A default variation refers to the variation responded when variation 0 is requested and/or in class 0, 1, 2, or 3 scans. The default variations for object types 1, 2, 20, 21, 22, 23, 30, and 32 are selected via relay settings. Refer to the *Communications* section in Chapter 5 for details. This optimizes the class 0 poll data size.

Note 2: For static (non-change-event) objects, qualifiers 17 or 28 are only responded when a request is sent with qualifiers 17 or 28, respectively. Otherwise, static object requests sent with qualifiers 00, 01, 06, 07, or 08, will be responded with qualifiers 00 or 01 (for change-event objects, qualifiers 17 or 28 are always responded.)

Note 3: Cold restarts are implemented the same as warm restarts – the F35 is not restarted, but the DNP process is restarted.

Table D–2: IMPLEMENTATION TABLE (Sheet 2 of 4)

OBJECT			REQUEST		RESPONSE	
OBJECT NO.	VARIATION NO.	DESCRIPTION	FUNCTION CODES (DEC)	QUALIFIER CODES (HEX)	FUNCTION CODES (DEC)	QUALIFIER CODES (HEX)
20 cont'd	2	16-Bit Binary Counter	1 (read) 7 (freeze) 8 (freeze noack) 9 (freeze clear) 10 (frz. cl. noack) 22 (assign class)	00, 01 (start-stop) 06 (no range, or all) 07, 08 (limited quantity) 17, 28 (index)	129 (response)	00, 01 (start-stop) 17, 28 (index) (see Note 2)
	5	32-Bit Binary Counter without Flag	1 (read) 7 (freeze) 8 (freeze noack) 9 (freeze clear) 10 (frz. cl. noack) 22 (assign class)	00, 01 (start-stop) 06 (no range, or all) 07, 08 (limited quantity) 17, 28 (index)	129 (response)	00, 01 (start-stop) 17, 28 (index) (see Note 2)
	6	16-Bit Binary Counter without Flag	1 (read) 7 (freeze) 8 (freeze noack) 9 (freeze clear) 10 (frz. cl. noack) 22 (assign class)	00, 01 (start-stop) 06 (no range, or all) 07, 08 (limited quantity) 17, 28 (index)	129 (response)	00, 01 (start-stop) 17, 28 (index) (see Note 2)
21	0	Frozen Counter (Variation 0 is used to request default variation)	1 (read) 22 (assign class)	00, 01 (start-stop) 06 (no range, or all) 07, 08 (limited quantity) 17, 28 (index)		
	1	32-Bit Frozen Counter	1 (read) 22 (assign class)	00, 01 (start-stop) 06 (no range, or all) 07, 08 (limited quantity) 17, 28 (index)	129 (response)	00, 01 (start-stop) 17, 28 (index) (see Note 2)
	2	16-Bit Frozen Counter	1 (read) 22 (assign class)	00, 01 (start-stop) 06 (no range, or all) 07, 08 (limited quantity) 17, 28 (index)	129 (response)	00, 01 (start-stop) 17, 28 (index) (see Note 2)
	9	32-Bit Frozen Counter without Flag	1 (read) 22 (assign class)	00, 01 (start-stop) 06 (no range, or all) 07, 08 (limited quantity) 17, 28 (index)	129 (response)	00, 01 (start-stop) 17, 28 (index) (see Note 2)
	10	16-Bit Frozen Counter without Flag	1 (read) 22 (assign class)	00, 01 (start-stop) 06 (no range, or all) 07, 08 (limited quantity) 17, 28 (index)	129 (response)	00, 01 (start-stop) 17, 28 (index) (see Note 2)
22	0	Counter Change Event (Variation 0 is used to request default variation)	1 (read)	06 (no range, or all) 07, 08 (limited quantity)		
	1	32-Bit Counter Change Event	1 (read)	06 (no range, or all) 07, 08 (limited quantity)	129 (response) 130 (unsol. resp.)	17, 28 (index)
	2	16-Bit Counter Change Event	1 (read)	06 (no range, or all) 07, 08 (limited quantity)	129 (response) 130 (unsol. resp.)	17, 28 (index)
	5	32-Bit Counter Change Event with Time	1 (read)	06 (no range, or all) 07, 08 (limited quantity)	129 (response) 130 (unsol. resp.)	17, 28 (index)
	6	16-Bit Counter Change Event with Time	1 (read)	06 (no range, or all) 07, 08 (limited quantity)	129 (response) 130 (unsol. resp.)	17, 28 (index)
23	0	Frozen Counter Event (Variation 0 is used to request default variation)	1 (read)	06 (no range, or all) 07, 08 (limited quantity)		
	1	32-Bit Frozen Counter Event	1 (read)	06 (no range, or all) 07, 08 (limited quantity)	129 (response) 130 (unsol. resp.)	17, 28 (index)
	2	16-Bit Frozen Counter Event	1 (read)	06 (no range, or all) 07, 08 (limited quantity)	129 (response) 130 (unsol. resp.)	17, 28 (index)

Note 1: A default variation refers to the variation responded when variation 0 is requested and/or in class 0, 1, 2, or 3 scans. The default variations for object types 1, 2, 20, 21, 22, 23, 30, and 32 are selected via relay settings. Refer to the *Communications* section in Chapter 5 for details. This optimizes the class 0 poll data size.

Note 2: For static (non-change-event) objects, qualifiers 17 or 28 are only responded when a request is sent with qualifiers 17 or 28, respectively. Otherwise, static object requests sent with qualifiers 00, 01, 06, 07, or 08, will be responded with qualifiers 00 or 01 (for change-event objects, qualifiers 17 or 28 are always responded.)

Note 3: Cold restarts are implemented the same as warm restarts – the F35 is not restarted, but the DNP process is restarted.

Table D–2: IMPLEMENTATION TABLE (Sheet 3 of 4)

OBJECT			REQUEST		RESPONSE	
OBJECT NO.	VARIATION NO.	DESCRIPTION	FUNCTION CODES (DEC)	QUALIFIER CODES (HEX)	FUNCTION CODES (DEC)	QUALIFIER CODES (HEX)
23 cont'd	5	32-Bit Frozen Counter Event with Time	1 (read)	06 (no range, or all) 07, 08 (limited quantity)	129 (response) 130 (unsol. resp.)	17, 28 (index)
	6	16-Bit Frozen Counter Event with Time	1 (read)	06 (no range, or all) 07, 08 (limited quantity)	129 (response) 130 (unsol. resp.)	17, 28 (index)
30	0	Analog Input (Variation 0 is used to request default variation)	1 (read) 22 (assign class)	00, 01 (start-stop) 06 (no range, or all) 07, 08 (limited quantity) 17, 28 (index)		
	1	32-Bit Analog Input	1 (read) 22 (assign class)	00, 01 (start-stop) 06 (no range, or all) 07, 08 (limited quantity) 17, 28 (index)	129 (response)	00, 01 (start-stop) 17, 28 (index) (see Note 2)
	2	16-Bit Analog Input	1 (read) 22 (assign class)	00, 01 (start-stop) 06 (no range, or all) 07, 08 (limited quantity) 17, 28 (index)	129 (response)	00, 01 (start-stop) 17, 28 (index) (see Note 2)
	3	32-Bit Analog Input without Flag	1 (read) 22 (assign class)	00, 01 (start-stop) 06 (no range, or all) 07, 08 (limited quantity) 17, 28 (index)	129 (response)	00, 01 (start-stop) 17, 28 (index) (see Note 2)
	4	16-Bit Analog Input without Flag	1 (read) 22 (assign class)	00, 01 (start-stop) 06 (no range, or all) 07, 08 (limited quantity) 17, 28 (index)	129 (response)	00, 01 (start-stop) 17, 28 (index) (see Note 2)
	5	short floating point	1 (read) 22 (assign class)	00, 01 (start-stop) 06 (no range, or all) 07, 08 (limited quantity) 17, 28 (index)	129 (response)	00, 01 (start-stop) 17, 28 (index) (see Note 2)
32	0	Analog Change Event (Variation 0 is used to request default variation)	1 (read)	06 (no range, or all) 07, 08 (limited quantity)		
	1	32-Bit Analog Change Event without Time	1 (read)	06 (no range, or all) 07, 08 (limited quantity)	129 (response) 130 (unsol. resp.)	17, 28 (index)
	2	16-Bit Analog Change Event without Time	1 (read)	06 (no range, or all) 07, 08 (limited quantity)	129 (response) 130 (unsol. resp.)	17, 28 (index)
	3	32-Bit Analog Change Event with Time	1 (read)	06 (no range, or all) 07, 08 (limited quantity)	129 (response) 130 (unsol. resp.)	17, 28 (index)
	4	16-Bit Analog Change Event with Time	1 (read)	06 (no range, or all) 07, 08 (limited quantity)	129 (response) 130 (unsol. resp.)	17, 28 (index)
	5	short floating point Analog Change Event without Time	1 (read)	06 (no range, or all) 07, 08 (limited quantity)	129 (response) 130 (unsol. resp.)	17, 28 (index)
34	0	Analog Input Reporting Deadband (Variation 0 is used to request default variation)	1 (read)	00, 01 (start-stop) 06 (no range, or all) 07, 08 (limited quantity) 17, 28 (index)		
	1	16-bit Analog Input Reporting Deadband (default – see Note 1)	1 (read) 2 (write)	00, 01 (start-stop) 06 (no range, or all) 07, 08 (limited quantity) 17, 28 (index) 00, 01 (start-stop) 07, 08 (limited quantity) 17, 28 (index)	129 (response)	00, 01 (start-stop) 17, 28 (index) (see Note 2)

Note 1: A default variation refers to the variation responded when variation 0 is requested and/or in class 0, 1, 2, or 3 scans. The default variations for object types 1, 2, 20, 21, 22, 23, 30, and 32 are selected via relay settings. Refer to the *Communications* section in Chapter 5 for details. This optimizes the class 0 poll data size.

Note 2: For static (non-change-event) objects, qualifiers 17 or 28 are only responded when a request is sent with qualifiers 17 or 28, respectively. Otherwise, static object requests sent with qualifiers 00, 01, 06, 07, or 08, will be responded with qualifiers 00 or 01 (for change-event objects, qualifiers 17 or 28 are always responded.)

Note 3: Cold restarts are implemented the same as warm restarts – the F35 is not restarted, but the DNP process is restarted.

Table D–2: IMPLEMENTATION TABLE (Sheet 4 of 4)

OBJECT			REQUEST		RESPONSE	
OBJECT NO.	VARIATION NO.	DESCRIPTION	FUNCTION CODES (DEC)	QUALIFIER CODES (HEX)	FUNCTION CODES (DEC)	QUALIFIER CODES (HEX)
34 cont'd	2	32-bit Analog Input Reporting Deadband	1 (read)	00, 01 (start-stop) 06 (no range, or all) 07, 08 (limited quantity) 17, 28 (index)	129 (response)	00, 01 (start-stop) 17, 28 (index) (see Note 2)
			2 (write)	00, 01 (start-stop) 07, 08 (limited quantity) 17, 28 (index)		
	3	Short floating point Analog Input Reporting Deadband	1 (read)	00, 01 (start-stop) 06 (no range, or all) 07, 08 (limited quantity) 17, 28 (index)	129 (response)	00, 01 (start-stop) 17, 28 (index) (see Note 2)
50	0	Time and Date	1 (read)	00, 01 (start-stop) 06 (no range, or all) 07, 08 (limited quantity) 17, 28 (index)	129 (response)	00, 01 (start-stop) 17, 28 (index) (see Note 2)
	1	Time and Date (default – see Note 1)	1 (read) 2 (write)	00, 01 (start-stop) 06 (no range, or all) 07 (limited qty=1) 08 (limited quantity) 17, 28 (index)	129 (response)	00, 01 (start-stop) 17, 28 (index) (see Note 2)
52	2	Time Delay Fine			129 (response)	07 (limited quantity) (quantity = 1)
60	0	Class 0, 1, 2, and 3 Data	1 (read) 20 (enable unsol) 21 (disable unsol) 22 (assign class)	06 (no range, or all)		
	1	Class 0 Data	1 (read) 22 (assign class)	06 (no range, or all)		
	2	Class 1 Data	1 (read) 20 (enable unsol) 21 (disable unsol) 22 (assign class)	06 (no range, or all) 07, 08 (limited quantity)		
	3	Class 2 Data	1 (read) 20 (enable unsol) 21 (disable unsol) 22 (assign class)	06 (no range, or all) 07, 08 (limited quantity)		
	4	Class 3 Data	1 (read) 20 (enable unsol) 21 (disable unsol) 22 (assign class)	06 (no range, or all) 07, 08 (limited quantity)		
80	1	Internal Indications	2 (write)	00 (start-stop) (index must =7)		
---		No Object (function code only) see Note 3	13 (cold restart)			
---		No Object (function code only)	14 (warm restart)			
---		No Object (function code only)	23 (delay meas.)			

Note 1: A default variation refers to the variation responded when variation 0 is requested and/or in class 0, 1, 2, or 3 scans. The default variations for object types 1, 2, 20, 21, 22, 23, 30, and 32 are selected via relay settings. Refer to the *Communications* section in Chapter 5 for details. This optimizes the class 0 poll data size.

Note 2: For static (non-change-event) objects, qualifiers 17 or 28 are only responded when a request is sent with qualifiers 17 or 28, respectively. Otherwise, static object requests sent with qualifiers 00, 01, 06, 07, or 08, will be responded with qualifiers 00 or 01 (for change-event objects, qualifiers 17 or 28 are always responded.)

Note 3: Cold restarts are implemented the same as warm restarts – the F35 is not restarted, but the DNP process is restarted.

D.2.1 BINARY INPUTS

The following table lists both Binary Counters (Object 20) and Frozen Counters (Object 21). When a freeze function is performed on a Binary Counter point, the frozen value is available in the corresponding Frozen Counter point.

BINARY INPUT POINTS

Static (Steady-State) Object Number: **1**

Change Event Object Number: **2**

Request Function Codes supported: **1 (read), 22 (assign class)**

Static Variation reported when variation 0 requested: **2 (Binary Input with status)**

Change Event Variation reported when variation 0 requested: **2 (Binary Input Change with Time)**

Change Event Scan Rate: **8 times per power system cycle**

Change Event Buffer Size: **1000**

D

Table D-3: BINARY INPUTS (Sheet 1 of 12)

point	name/description	change event class
0	Virtual Input 1	2
1	Virtual Input 2	2
2	Virtual Input 3	2
3	Virtual Input 4	2
4	Virtual Input 5	2
5	Virtual Input 6	2
6	Virtual Input 7	2
7	Virtual Input 8	2
8	Virtual Input 9	2
9	Virtual Input 10	2
10	Virtual Input 11	2
11	Virtual Input 12	2
12	Virtual Input 13	2
13	Virtual Input 14	2
14	Virtual Input 15	2
15	Virtual Input 16	2
16	Virtual Input 17	2
17	Virtual Input 18	2
18	Virtual Input 19	2
19	Virtual Input 20	2
20	Virtual Input 21	2
21	Virtual Input 22	2
22	Virtual Input 23	2
23	Virtual Input 24	2
24	Virtual Input 25	2
25	Virtual Input 26	2
26	Virtual Input 27	2
27	Virtual Input 28	2
28	Virtual Input 29	2
29	Virtual Input 30	2

Table D-3: BINARY INPUTS (Sheet 2 of 12)

point	name/description	change event class
30	Virtual Input 31	2
31	Virtual Input 32	2
32	Virtual Output 1	2
33	Virtual Output 2	2
34	Virtual Output 3	2
35	Virtual Output 4	2
36	Virtual Output 5	2
37	Virtual Output 6	2
38	Virtual Output 7	2
39	Virtual Output 8	2
40	Virtual Output 9	2
41	Virtual Output 10	2
42	Virtual Output 11	2
43	Virtual Output 12	2
44	Virtual Output 13	2
45	Virtual Output 14	2
46	Virtual Output 15	2
47	Virtual Output 16	2
48	Virtual Output 17	2
49	Virtual Output 18	2
50	Virtual Output 19	2
51	Virtual Output 20	2
52	Virtual Output 21	2
53	Virtual Output 22	2
54	Virtual Output 23	2
55	Virtual Output 24	2
56	Virtual Output 25	2
57	Virtual Output 26	2
58	Virtual Output 27	2
59	Virtual Output 28	2

Table D-3: BINARY INPUTS (Sheet 3 of 12)

point	name/description	change event class
60	Virtual Output 29	2
61	Virtual Output 30	2
62	Virtual Output 31	2
63	Virtual Output 32	2
64	Virtual Output 33	2
65	Virtual Output 34	2
66	Virtual Output 35	2
67	Virtual Output 36	2
68	Virtual Output 37	2
69	Virtual Output 38	2
70	Virtual Output 39	2
71	Virtual Output 40	2
72	Virtual Output 41	2
73	Virtual Output 42	2
74	Virtual Output 43	2
75	Virtual Output 44	2
76	Virtual Output 45	2
77	Virtual Output 46	2
78	Virtual Output 47	2
79	Virtual Output 48	2
80	Virtual Output 49	2
81	Virtual Output 50	2
82	Virtual Output 51	2
83	Virtual Output 52	2
84	Virtual Output 53	2
85	Virtual Output 54	2
86	Virtual Output 55	2
87	Virtual Output 56	2
88	Virtual Output 57	2
89	Virtual Output 58	2
90	Virtual Output 59	2
91	Virtual Output 60	2
92	Virtual Output 61	2
93	Virtual Output 62	2
94	Virtual Output 63	2
95	Virtual Output 64	2
96	Contact Input 1	1
97	Contact Input 2	1
98	Contact Input 3	1
99	Contact Input 4	1
100	Contact Input 5	1
101	Contact Input 6	1
102	Contact Input 7	1
103	Contact Input 8	1
104	Contact Input 9	1
105	Contact Input 10	1
106	Contact Input 11	1

Table D-3: BINARY INPUTS (Sheet 4 of 12)

point	name/description	change event class
107	Contact Input 12	1
108	Contact Input 13	1
109	Contact Input 14	1
110	Contact Input 15	1
111	Contact Input 16	1
112	Contact Input 17	1
113	Contact Input 18	1
114	Contact Input 19	1
115	Contact Input 20	1
116	Contact Input 21	1
117	Contact Input 22	1
118	Contact Input 23	1
119	Contact Input 24	1
120	Contact Input 25	1
121	Contact Input 26	1
122	Contact Input 27	1
123	Contact Input 28	1
124	Contact Input 29	1
125	Contact Input 30	1
126	Contact Input 31	1
127	Contact Input 32	1
128	Contact Input 33	1
129	Contact Input 34	1
130	Contact Input 35	1
131	Contact Input 36	1
132	Contact Input 37	1
133	Contact Input 38	1
134	Contact Input 39	1
135	Contact Input 40	1
136	Contact Input 41	1
137	Contact Input 42	1
138	Contact Input 43	1
139	Contact Input 44	1
140	Contact Input 45	1
141	Contact Input 46	1
142	Contact Input 47	1
143	Contact Input 48	1
144	Contact Input 49	1
145	Contact Input 50	1
146	Contact Input 51	1
147	Contact Input 52	1
148	Contact Input 53	1
149	Contact Input 54	1
150	Contact Input 55	1
151	Contact Input 56	1
152	Contact Input 57	1
153	Contact Input 58	1

Table D-3: BINARY INPUTS (Sheet 5 of 12)

point	name/description	change event class
154	Contact Input 59	1
155	Contact Input 60	1
156	Contact Input 61	1
157	Contact Input 62	1
158	Contact Input 63	1
159	Contact Input 64	1
160	Contact Input 65	1
161	Contact Input 66	1
162	Contact Input 67	1
163	Contact Input 68	1
164	Contact Input 69	1
165	Contact Input 70	1
166	Contact Input 71	1
167	Contact Input 72	1
168	Contact Input 73	1
169	Contact Input 74	1
170	Contact Input 75	1
171	Contact Input 76	1
172	Contact Input 77	1
173	Contact Input 78	1
174	Contact Input 79	1
175	Contact Input 80	1
176	Contact Input 81	1
177	Contact Input 82	1
178	Contact Input 83	1
179	Contact Input 84	1
180	Contact Input 85	1
181	Contact Input 86	1
182	Contact Input 87	1
183	Contact Input 88	1
184	Contact Input 89	1
185	Contact Input 90	1
186	Contact Input 91	1
187	Contact Input 92	1
188	Contact Input 93	1
189	Contact Input 94	1
190	Contact Input 95	1
191	Contact Input 96	1
192	Contact Output 1	1
193	Contact Output 2	1
194	Contact Output 3	1
195	Contact Output 4	1
196	Contact Output 5	1
197	Contact Output 6	1
198	Contact Output 7	1
199	Contact Output 8	1
200	Contact Output 9	1

Table D-3: BINARY INPUTS (Sheet 6 of 12)

point	name/description	change event class
201	Contact Output 10	1
202	Contact Output 11	1
203	Contact Output 12	1
204	Contact Output 13	1
205	Contact Output 14	1
206	Contact Output 15	1
207	Contact Output 16	1
208	Contact Output 17	1
209	Contact Output 18	1
210	Contact Output 19	1
211	Contact Output 20	1
212	Contact Output 21	1
213	Contact Output 22	1
214	Contact Output 23	1
215	Contact Output 24	1
216	Contact Output 25	1
217	Contact Output 26	1
218	Contact Output 27	1
219	Contact Output 28	1
220	Contact Output 29	1
221	Contact Output 30	1
222	Contact Output 31	1
223	Contact Output 32	1
224	Contact Output 33	1
225	Contact Output 34	1
226	Contact Output 35	1
227	Contact Output 36	1
228	Contact Output 37	1
229	Contact Output 38	1
230	Contact Output 39	1
231	Contact Output 40	1
232	Contact Output 41	1
233	Contact Output 42	1
234	Contact Output 43	1
235	Contact Output 44	1
236	Contact Output 45	1
237	Contact Output 46	1
238	Contact Output 47	1
239	Contact Output 48	1
240	Contact Output 49	1
241	Contact Output 50	1
242	Contact Output 51	1
243	Contact Output 52	1
244	Contact Output 53	1
245	Contact Output 54	1
246	Contact Output 55	1
247	Contact Output 56	1

Table D-3: BINARY INPUTS (Sheet 7 of 12)

point	name/description	change event class
248	Contact Output 57	1
249	Contact Output 58	1
250	Contact Output 59	1
251	Contact Output 60	1
252	Contact Output 61	1
253	Contact Output 62	1
254	Contact Output 63	1
255	Contact Output 64	1
256	Remote Input 1	1
257	Remote Input 2	1
258	Remote Input 3	1
259	Remote Input 4	1
260	Remote Input 5	1
261	Remote Input 6	1
262	Remote Input 7	1
263	Remote Input 8	1
264	Remote Input 9	1
265	Remote Input 10	1
266	Remote Input 11	1
267	Remote Input 12	1
268	Remote Input 13	1
269	Remote Input 14	1
270	Remote Input 15	1
271	Remote Input 16	1
272	Remote Input 17	1
273	Remote Input 18	1
274	Remote Input 19	1
275	Remote Input 20	1
276	Remote Input 21	1
277	Remote Input 22	1
278	Remote Input 23	1
279	Remote Input 24	1
280	Remote Input 25	1
281	Remote Input 26	1
282	Remote Input 27	1
283	Remote Input 28	1
284	Remote Input 29	1
285	Remote Input 30	1
286	Remote Input 31	1
287	Remote Input 32	1
288	Remote Device 1	1
289	Remote Device 2	1
290	Remote Device 3	1
291	Remote Device 4	1
292	Remote Device 5	1
293	Remote Device 6	1
294	Remote Device 7	1

Table D-3: BINARY INPUTS (Sheet 8 of 12)

point	name/description	change event class
295	Remote Device 8	1
296	Remote Device 9	1
297	Remote Device 10	1
298	Remote Device 11	1
299	Remote Device 12	1
300	Remote Device 13	1
301	Remote Device 14	1
302	Remote Device 15	1
303	Remote Device 16	1
304	Phase Instantaneous Overcurrent 1	1
305	Phase Instantaneous Overcurrent 2	1
306	Phase Instantaneous Overcurrent 3	1
307	Phase Instantaneous Overcurrent 4	1
308	Phase Instantaneous Overcurrent 5	1
309	Phase Instantaneous Overcurrent 6	1
310	Phase Instantaneous Overcurrent 7	1
311	Phase Instantaneous Overcurrent 8	1
312	Phase Instantaneous Overcurrent 9	1
313	Phase Instantaneous Overcurrent 10	1
314	Phase Instantaneous Overcurrent 11	1
315	Phase Instantaneous Overcurrent 12	1
320	Phase Time Overcurrent 1	1
321	Phase Time Overcurrent 2	1
322	Phase Time Overcurrent 3	1
323	Phase Time Overcurrent 4	1
324	Phase Time Overcurrent 5	1
325	Phase Time Overcurrent 6	1
336	Neutral Instantaneous Overcurrent 1	1
337	Neutral Instantaneous Overcurrent 2	1
338	Neutral Instantaneous Overcurrent 3	1
339	Neutral Instantaneous Overcurrent 4	1
340	Neutral Instantaneous Overcurrent 5	1
341	Neutral Instantaneous Overcurrent 6	1
342	Neutral Instantaneous Overcurrent 7	1
343	Neutral Instantaneous Overcurrent 8	1
344	Neutral Instantaneous Overcurrent 9	1
345	Neutral Instantaneous Overcurrent 10	1
346	Neutral Instantaneous Overcurrent 11	1
347	Neutral Instantaneous Overcurrent 12	1
352	Neutral Time Overcurrent 1	1
353	Neutral Time Overcurrent 2	1
354	Neutral Time Overcurrent 3	1
355	Neutral Time Overcurrent 4	1
356	Neutral Time Overcurrent 5	1
357	Neutral Time Overcurrent 6	1
368	Ground Instantaneous Overcurrent 1	1
369	Ground Instantaneous Overcurrent 2	1

Table D-3: BINARY INPUTS (Sheet 9 of 12)

point	name/description	change event class
370	Ground Instantaneous Overcurrent 3	1
371	Ground Instantaneous Overcurrent 4	1
372	Ground Instantaneous Overcurrent 5	1
373	Ground Instantaneous Overcurrent 6	1
374	Ground Instantaneous Overcurrent 7	1
375	Ground Instantaneous Overcurrent 8	1
376	Ground Instantaneous Overcurrent 9	1
377	Ground Instantaneous Overcurrent 10	1
378	Ground Instantaneous Overcurrent 11	1
379	Ground Instantaneous Overcurrent 12	1
384	Ground Time Overcurrent 1	1
385	Ground Time Overcurrent 2	1
386	Ground Time Overcurrent 3	1
387	Ground Time Overcurrent 4	1
388	Ground Time Overcurrent 5	1
389	Ground Time Overcurrent 6	1
444	Auxiliary Undervoltage 1	1
448	Phase Undervoltage 1	1
449	Phase Undervoltage 2	1
452	Auxiliary Overvoltage 1	1
460	Neutral Overvoltage 1	1
592	Breaker Arcing Current 1	1
593	Breaker Arcing Current 2	1
594	Breaker Arcing Current 3	1
595	Breaker Arcing Current 4	1
596	Breaker Arcing Current 5	1
597	Breaker Arcing Current 6	1
608	Autoreclose 1	1
609	Autoreclose 2	1
610	Autoreclose 3	1
611	Autoreclose 4	1
612	Autoreclose 5	1
613	Autoreclose 6	1
640	Setting Group	1
641	Reset	1
656	Underfrequency 1	1
657	Underfrequency 2	1
658	Underfrequency 3	1
659	Underfrequency 4	1
660	Underfrequency 5	1
661	Underfrequency 6	1
689	Selector Switch 1	1
690	Selector Switch 2	1
694	Control Pushbutton 1	1
695	Control Pushbutton 2	1
696	Control Pushbutton 3	1
697	Control Pushbutton 4	1

Table D-3: BINARY INPUTS (Sheet 10 of 12)

point	name/description	change event class
698	Control Pushbutton 5	1
699	Control Pushbutton 6	1
700	Control Pushbutton 7	1
704	FlexElement™ 1	1
705	FlexElement™ 2	1
706	FlexElement™ 3	1
707	FlexElement™ 4	1
708	FlexElement™ 5	1
709	FlexElement™ 6	1
710	FlexElement™ 7	1
711	FlexElement™ 8	1
724	Non-Volatile Latch 1	1
725	Non-Volatile Latch 2	1
726	Non-Volatile Latch 3	1
727	Non-Volatile Latch 4	1
728	Non-Volatile Latch 5	1
729	Non-Volatile Latch 6	1
730	Non-Volatile Latch 7	1
731	Non-Volatile Latch 8	1
732	Non-Volatile Latch 9	1
733	Non-Volatile Latch 10	1
734	Non-Volatile Latch 11	1
735	Non-Volatile Latch 12	1
736	Non-Volatile Latch 13	1
737	Non-Volatile Latch 14	1
738	Non-Volatile Latch 15	1
739	Non-Volatile Latch 16	1
816	Digital Element 1	1
817	Digital Element 2	1
818	Digital Element 3	1
819	Digital Element 4	1
820	Digital Element 5	1
821	Digital Element 6	1
822	Digital Element 7	1
823	Digital Element 8	1
824	Digital Element 9	1
825	Digital Element 10	1
826	Digital Element 11	1
827	Digital Element 12	1
828	Digital Element 13	1
829	Digital Element 14	1
830	Digital Element 15	1
831	Digital Element 16	1
840	Eight-Bit Switch 1	1
841	Eight-Bit Switch 2	1
842	Eight-Bit Switch 3	1
843	Eight-Bit Switch 4	1

Table D-3: BINARY INPUTS (Sheet 11 of 12)

point	name/description	change event class
844	Eight-Bit Switch 5	1
845	Eight-Bit Switch 6	1
848	Digital Counter 1	1
849	Digital Counter 2	1
850	Digital Counter 3	1
851	Digital Counter 4	1
852	Digital Counter 5	1
853	Digital Counter 6	1
854	Digital Counter 7	1
855	Digital Counter 8	1
864	LED State 1 (IN SERVICE)	1
865	LED State 2 (TROUBLE)	1
866	LED State 3 (TEST MODE)	1
867	LED State 4 (TRIP)	1
868	LED State 5 (ALARM)	1
869	LED State 6 (PICKUP)	1
880	LED State 9 (VOLTAGE)	1
881	LED State 10 (CURRENT)	1
882	LED State 11 (FREQUENCY)	1
883	LED State 12 (OTHER)	1
884	LED State 13 (PHASE A)	1
885	LED State 14 (PHASE B)	1
886	LED State 15 (PHASE C)	1
887	LED State 16 (NTL/GROUND)	1
898	SNTP FAILURE	1
899	BATTERY FAIL	1
900	PRI ETHERNET FAIL	1
901	SEC ETHERNET FAIL	1
902	EEPROM DATA ERROR	1
903	SRAM DATA ERROR	1
904	PROGRAM MEMORY	1
905	WATCHDOG ERROR	1
906	LOW ON MEMORY	1
907	REMOTE DEVICE OFF	1
908	DIRECT DEVICE OFF	
909	DIRECT RING BREAK	
910	ANY MINOR ERROR	1
911	ANY MAJOR ERROR	1
912	ANY SELF-TESTS	1
913	IRIG-B FAILURE	1
914	DSP ERROR	1
916	NO DSP INTERRUPTS	1
917	UNIT NOT CALIBRATED	1
921	PROTOTYPE FIRMWARE	1
922	FLEXLOGIC ERR TOKEN	1
923	EQUIPMENT MISMATCH	1
925	UNIT NOT PROGRAMMED	1

Table D-3: BINARY INPUTS (Sheet 12 of 12)

point	name/description	change event class
926	SYSTEM EXCEPTION	1
927	LATCHING OUT ERROR	1
984	User-Programmable Pushbutton 1	1
985	User-Programmable Pushbutton 2	1
986	User-Programmable Pushbutton 3	1
987	User-Programmable Pushbutton 4	1
988	User-Programmable Pushbutton 5	1
989	User-Programmable Pushbutton 6	1
990	User-Programmable Pushbutton 7	1
991	User-Programmable Pushbutton 8	1
992	User-Programmable Pushbutton 9	1
993	User-Programmable Pushbutton 10	1
994	User-Programmable Pushbutton 11	1
995	User-Programmable Pushbutton 12	1

D.2.2 BINARY AND CONTROL RELAY OUTPUTS

Supported Control Relay Output Block fields: Pulse On, Pulse Off, Latch On, Latch Off, Paired Trip, Paired Close.

BINARY OUTPUT STATUS POINTS

Object Number: **10**

Request Function Codes supported: **1 (read)**

Default Variation reported when Variation 0 requested: **2 (Binary Output Status)**

CONTROL RELAY OUTPUT BLOCKS

Object Number: **12**

Request Function Codes supported: **3 (select), 4 (operate), 5 (direct operate), 6 (direct operate, noack)**

Table D-4: BINARY/CONTROL OUTPUTS

POINT	NAME/DESCRIPTION
0	Virtual Input 1
1	Virtual Input 2
2	Virtual Input 3
3	Virtual Input 4
4	Virtual Input 5
5	Virtual Input 6
6	Virtual Input 7
7	Virtual Input 8
8	Virtual Input 9
9	Virtual Input 10
10	Virtual Input 11
11	Virtual Input 12
12	Virtual Input 13
13	Virtual Input 14
14	Virtual Input 15
15	Virtual Input 16
16	Virtual Input 17
17	Virtual Input 18
18	Virtual Input 19
19	Virtual Input 20
20	Virtual Input 21
21	Virtual Input 22
22	Virtual Input 23
23	Virtual Input 24
24	Virtual Input 25
25	Virtual Input 26
26	Virtual Input 27
27	Virtual Input 28
28	Virtual Input 29
29	Virtual Input 30
30	Virtual Input 31
31	Virtual Input 32

D.2.3 COUNTERS

The following table lists both Binary Counters (Object 20) and Frozen Counters (Object 21). When a freeze function is performed on a Binary Counter point, the frozen value is available in the corresponding Frozen Counter point.

BINARY COUNTERS	
Static (Steady-State) Object Number:	20
Change Event Object Number:	22
Request Function Codes supported:	1 (read), 7 (freeze), 8 (freeze noack), 9 (freeze and clear), 10 (freeze and clear, noack), 22 (assign class)
Static Variation reported when variation 0 requested:	1 (32-Bit Binary Counter with Flag)
Change Event Variation reported when variation 0 requested:	1 (32-Bit Counter Change Event without time)
Change Event Buffer Size:	10
Default Class for all points:	2
FROZEN COUNTERS	
Static (Steady-State) Object Number:	21
Change Event Object Number:	23
Request Function Codes supported:	1 (read)
Static Variation reported when variation 0 requested:	1 (32-Bit Frozen Counter with Flag)
Change Event Variation reported when variation 0 requested:	1 (32-Bit Frozen Counter Event without time)
Change Event Buffer Size:	10
Default Class for all points:	2

Table D-5: BINARY AND FROZEN COUNTERS

POINT INDEX	NAME/DESCRIPTION
0	Digital Counter 1
1	Digital Counter 2
2	Digital Counter 3
3	Digital Counter 4
4	Digital Counter 5
5	Digital Counter 6
6	Digital Counter 7
7	Digital Counter 8
8	Oscillography Trigger Count
9	Events Since Last Clear

A counter freeze command has no meaning for counters 8 and 9. F35 Digital Counter values are represented as 32-bit integers. The DNP 3.0 protocol defines counters to be unsigned integers. Care should be taken when interpreting negative counter values.

D.2.4 ANALOG INPUTS

The following table lists Analog Inputs (Object 30). It is important to note that 16-bit and 32-bit variations of analog inputs are transmitted through DNP as signed numbers. Even for analog input points that are not valid as negative values, the maximum positive representation is 32767 for 16-bit values and 2147483647 for 32-bit values. This is a DNP requirement.

The deadbands for all Analog Input points are in the same units as the Analog Input quantity. For example, an Analog Input quantity measured in volts has a corresponding deadband in units of volts. This is in conformance with DNP Technical Bulletin 9809-001 Analog Input Reporting Deadband. Relay settings are available to set default deadband values according to data type. Deadbands for individual Analog Input Points can be set using DNP Object 34.

When using the F35 in DNP systems with limited memory, the Analog Input Points below may be replaced with a user-definable list. This user-definable list uses the same settings as the Modbus User Map and can be configured with the Modbus User Map settings. When used with DNP, each entry in the Modbus User Map represents the starting Modbus address of a data item available as a DNP Analog Input point. To enable use of the Modbus User Map for DNP Analog Input points, set the **USER MAP FOR DNP ANALOGS** setting to Enabled (this setting is in the **PRODUCT SETUP** ⇌ **COMMUNICATIONS** ⇌ **DNP PROTOCOL** menu). The new DNP Analog points list can be checked via the “DNP Analog Input Points List” webpage, accessible from the “Device Information menu” webpage.



After changing the **USER MAP FOR DNP ANALOGS** setting, the relay must be powered off and then back on for the setting to take effect.

D

Only Source 1 data points are shown in the following table. If the **NUMBER OF SOURCES IN ANALOG LIST** setting is increased, data points for subsequent sources will be added to the list immediately following the Source 1 data points.

Units for Analog Input points are as follows:

- Current: A (amps)
- Voltage: V (volts)
- Real Power: W (watts)
- Reactive Power: var (vars)
- Apparent Power: VA (volt-amperes)
- Energy: Wh, varh (watt-hours, var-hours)
- Frequency: Hz (hertz)
- Angle: degrees
- Ohm Input: ohms
- RTD Input: °C (degrees Celsius)

Static (Steady-State) Object Number: **30**

Change Event Object Number: **32**

Request Function Codes supported: **1 (read), 2 (write, deadbands only), 22 (assign class)**

Static Variation reported when variation 0 requested: **1 (32-Bit Analog Input)**

Change Event Variation reported when variation 0 requested: **1 (Analog Change Event without Time)**

Change Event Scan Rate: defaults to **500 ms**

Change Event Buffer Size: **800**

Default Class for all Points: **1**

Table D-6: ANALOG INPUT POINTS (Sheet 1 of 6)

POINT	DESCRIPTION
0	SRC 1 Phase A Current RMS
1	SRC 1 Phase B Current RMS
2	SRC 1 Phase C Current RMS
3	SRC 1 Neutral Current RMS
4	SRC 1 Phase A Current Magnitude
5	SRC 1 Phase A Current Angle
6	SRC 1 Phase B Current Magnitude
7	SRC 1 Phase B Current Angle
8	SRC 1 Phase C Current Magnitude
9	SRC 1 Phase C Current Angle
10	SRC 1 Neutral Current Magnitude
11	SRC 1 Neutral Current Angle
12	SRC 1 Ground Current RMS
13	SRC 1 Ground Current Magnitude
14	SRC 1 Ground Current Angle
15	SRC 1 Zero Sequence Current Magnitude
16	SRC 1 Zero Sequence Current Angle
17	SRC 1 Positive Sequence Current Magnitude
18	SRC 1 Positive Sequence Current Angle
19	SRC 1 Negative Sequence Current Magnitude
20	SRC 1 Negative Sequence Current Angle
21	SRC 1 Differential Ground Current Magnitude
22	SRC 1 Differential Ground Current Angle
23	SRC 1 Phase AG Voltage RMS
24	SRC 1 Phase BG Voltage RMS
25	SRC 1 Phase CG Voltage RMS
26	SRC 1 Phase AG Voltage Magnitude
27	SRC 1 Phase AG Voltage Angle
28	SRC 1 Phase BG Voltage Magnitude
29	SRC 1 Phase BG Voltage Angle
30	SRC 1 Phase CG Voltage Magnitude
31	SRC 1 Phase CG Voltage Angle
32	SRC 1 Phase AB Voltage RMS
33	SRC 1 Phase BC Voltage RMS
34	SRC 1 Phase CA Voltage RMS
35	SRC 1 Phase AB Voltage Magnitude
36	SRC 1 Phase AB Voltage Angle
37	SRC 1 Phase BC Voltage Magnitude
38	SRC 1 Phase BC Voltage Angle
39	SRC 1 Phase CA Voltage Magnitude
40	SRC 1 Phase CA Voltage Angle
41	SRC 1 Auxiliary Voltage RMS
42	SRC 1 Auxiliary Voltage Magnitude
43	SRC 1 Auxiliary Voltage Angle
44	SRC 1 Zero Sequence Voltage Magnitude
45	SRC 1 Zero Sequence Voltage Angle
46	SRC 1 Positive Sequence Voltage Magnitude
47	SRC 1 Positive Sequence Voltage Angle
48	SRC 1 Negative Sequence Voltage Magnitude
49	SRC 1 Negative Sequence Voltage Angle
50	SRC 1 Three Phase Real Power
51	SRC 1 Phase A Real Power

Table D-6: ANALOG INPUT POINTS (Sheet 2 of 6)

POINT	DESCRIPTION
52	SRC 1 Phase B Real Power
53	SRC 1 Phase C Real Power
54	SRC 1 Three Phase Reactive Power
55	SRC 1 Phase A Reactive Power
56	SRC 1 Phase B Reactive Power
57	SRC 1 Phase C Reactive Power
58	SRC 1 Three Phase Apparent Power
59	SRC 1 Phase A Apparent Power
60	SRC 1 Phase B Apparent Power
61	SRC 1 Phase C Apparent Power
62	SRC 1 Three Phase Power Factor
63	SRC 1 Phase A Power Factor
64	SRC 1 Phase B Power Factor
65	SRC 1 Phase C Power Factor
66	SRC 1 Positive Watthour
67	SRC 1 Negative Watthour
68	SRC 1 Positive Varhour
69	SRC 1 Negative Varhour
70	SRC 1 Frequency
71	SRC 1 Demand Ia
72	SRC 1 Demand Ib
73	SRC 1 Demand Ic
74	SRC 1 Demand Watt
75	SRC 1 Demand Var
76	SRC 1 Demand Va
77	SRC 1 Va THD
78	SRC 1 Va Harmonics[0]
79	SRC 1 Va Harmonics[1]
80	SRC 1 Va Harmonics[2]
81	SRC 1 Va Harmonics[3]
82	SRC 1 Va Harmonics[4]
83	SRC 1 Va Harmonics[5]
84	SRC 1 Va Harmonics[6]
85	SRC 1 Va Harmonics[7]
86	SRC 1 Va Harmonics[8]
87	SRC 1 Va Harmonics[9]
88	SRC 1 Va Harmonics[10]
89	SRC 1 Va Harmonics[11]
90	SRC 1 Va Harmonics[12]
91	SRC 1 Va Harmonics[13]
92	SRC 1 Va Harmonics[14]
93	SRC 1 Va Harmonics[15]
94	SRC 1 Va Harmonics[16]
95	SRC 1 Va Harmonics[17]
96	SRC 1 Va Harmonics[18]
97	SRC 1 Va Harmonics[19]
98	SRC 1 Va Harmonics[20]
99	SRC 1 Va Harmonics[21]
100	SRC 1 Va Harmonics[22]
101	SRC 1 Va Harmonics[23]
102	SRC 1 Vb THD
103	SRC 1 Vb Harmonics[0]

Table D-6: ANALOG INPUT POINTS (Sheet 3 of 6)

POINT	DESCRIPTION
104	SRC 1 Vb Harmonics[1]
105	SRC 1 Vb Harmonics[2]
106	SRC 1 Vb Harmonics[3]
107	SRC 1 Vb Harmonics[4]
108	SRC 1 Vb Harmonics[5]
109	SRC 1 Vb Harmonics[6]
110	SRC 1 Vb Harmonics[7]
111	SRC 1 Vb Harmonics[8]
112	SRC 1 Vb Harmonics[9]
113	SRC 1 Vb Harmonics[10]
114	SRC 1 Vb Harmonics[11]
115	SRC 1 Vb Harmonics[12]
116	SRC 1 Vb Harmonics[13]
117	SRC 1 Vb Harmonics[14]
118	SRC 1 Vb Harmonics[15]
119	SRC 1 Vb Harmonics[16]
120	SRC 1 Vb Harmonics[17]
121	SRC 1 Vb Harmonics[18]
122	SRC 1 Vb Harmonics[19]
123	SRC 1 Vb Harmonics[20]
124	SRC 1 Vb Harmonics[21]
125	SRC 1 Vb Harmonics[22]
126	SRC 1 Vb Harmonics[23]
127	SRC 1 Vc THD
128	SRC 1 Vc Harmonics[0]
129	SRC 1 Vc Harmonics[1]
130	SRC 1 Vc Harmonics[2]
131	SRC 1 Vc Harmonics[3]
132	SRC 1 Vc Harmonics[4]
133	SRC 1 Vc Harmonics[5]
134	SRC 1 Vc Harmonics[6]
135	SRC 1 Vc Harmonics[7]
136	SRC 1 Vc Harmonics[8]
137	SRC 1 Vc Harmonics[9]
138	SRC 1 Vc Harmonics[10]
139	SRC 1 Vc Harmonics[11]
140	SRC 1 Vc Harmonics[12]
141	SRC 1 Vc Harmonics[13]
142	SRC 1 Vc Harmonics[14]
143	SRC 1 Vc Harmonics[15]
144	SRC 1 Vc Harmonics[16]
145	SRC 1 Vc Harmonics[17]
146	SRC 1 Vc Harmonics[18]
147	SRC 1 Vc Harmonics[19]
148	SRC 1 Vc Harmonics[20]
149	SRC 1 Vc Harmonics[21]
150	SRC 1 Vc Harmonics[22]
151	SRC 1 Vc Harmonics[23]
152	Fault 1 Prefault Phase A Current Magnitude
153	Fault 1 Prefault Phase A Current Angle
154	Fault 1 Prefault Phase B Current Magnitude
155	Fault 1 Prefault Phase B Current Angle

Table D-6: ANALOG INPUT POINTS (Sheet 4 of 6)

POINT	DESCRIPTION
156	Fault 1 Prefault Phase C Current Magnitude
157	Fault 1 Prefault Phase C Current Angle
158	Fault 1 Prefault Phase A Voltage Magnitude
159	Fault 1 Prefault Phase A Voltage Angle
160	Fault 1 Prefault Phase B Voltage Magnitude
161	Fault 1 Prefault Phase B Voltage Angle
162	Fault 1 Prefault Phase C Voltage Magnitude
163	Fault 1 Prefault Phase C Voltage Angle
164	Fault 1 Postfault Phase A Current Magnitude
165	Fault 1 Postfault Phase A Current Angle
166	Fault 1 Postfault Phase B Current Magnitude
167	Fault 1 Postfault Phase B Current Angle
168	Fault 1 Postfault Phase C Current Magnitude
169	Fault 1 Postfault Phase C Current Angle
170	Fault 1 Postfault Phase A Voltage Magnitude
171	Fault 1 Postfault Phase A Voltage Angle
172	Fault 1 Postfault Phase B Voltage Magnitude
173	Fault 1 Postfault Phase B Voltage Angle
174	Fault 1 Postfault Phase C Voltage Magnitude
175	Fault 1 Postfault Phase C Voltage Angle
176	Fault 1 Type
177	Fault 1 Location
178	Fault 2 Prefault Phase A Current Magnitude
179	Fault 2 Prefault Phase A Current Angle
180	Fault 2 Prefault Phase B Current Magnitude
181	Fault 2 Prefault Phase B Current Angle
182	Fault 2 Prefault Phase C Current Magnitude
183	Fault 2 Prefault Phase C Current Angle
184	Fault 2 Prefault Phase A Voltage Magnitude
185	Fault 2 Prefault Phase A Voltage Angle
186	Fault 2 Prefault Phase B Voltage Magnitude
187	Fault 2 Prefault Phase B Voltage Angle
188	Fault 2 Prefault Phase C Voltage Magnitude
189	Fault 2 Prefault Phase C Voltage Angle
190	Fault 2 Postfault Phase A Current Magnitude
191	Fault 2 Postfault Phase A Current Angle
192	Fault 2 Postfault Phase B Current Magnitude
193	Fault 2 Postfault Phase B Current Angle
194	Fault 2 Postfault Phase C Current Magnitude
195	Fault 2 Postfault Phase C Current Angle
196	Fault 2 Postfault Phase A Voltage Magnitude
197	Fault 2 Postfault Phase A Voltage Angle
198	Fault 2 Postfault Phase B Voltage Magnitude
199	Fault 2 Postfault Phase B Voltage Angle
200	Fault 2 Postfault Phase C Voltage Magnitude
201	Fault 2 Postfault Phase C Voltage Angle
202	Fault 2 Type
203	Fault 2 Location
204	Fault 3 Prefault Phase A Current Magnitude
205	Fault 3 Prefault Phase A Current Angle
206	Fault 3 Prefault Phase B Current Magnitude
207	Fault 3 Prefault Phase B Current Angle

Table D-6: ANALOG INPUT POINTS (Sheet 5 of 6)

POINT	DESCRIPTION
208	Fault 3 Prefault Phase C Current Magnitude
209	Fault 3 Prefault Phase C Current Angle
210	Fault 3 Prefault Phase A Voltage Magnitude
211	Fault 3 Prefault Phase A Voltage Angle
212	Fault 3 Prefault Phase B Voltage Magnitude
213	Fault 3 Prefault Phase B Voltage Angle
214	Fault 3 Prefault Phase C Voltage Magnitude
215	Fault 3 Prefault Phase C Voltage Angle
216	Fault 3 Postfault Phase A Current Magnitude
217	Fault 3 Postfault Phase A Current Angle
218	Fault 3 Postfault Phase B Current Magnitude
219	Fault 3 Postfault Phase B Current Angle
220	Fault 3 Postfault Phase C Current Magnitude
221	Fault 3 Postfault Phase C Current Angle
222	Fault 3 Postfault Phase A Voltage Magnitude
223	Fault 3 Postfault Phase A Voltage Angle
224	Fault 3 Postfault Phase B Voltage Magnitude
225	Fault 3 Postfault Phase B Voltage Angle
226	Fault 3 Postfault Phase C Voltage Magnitude
227	Fault 3 Postfault Phase C Voltage Angle
228	Fault 3 Type
229	Fault 3 Location
230	Fault 4 Prefault Phase A Current Magnitude
231	Fault 4 Prefault Phase A Current Angle
232	Fault 4 Prefault Phase B Current Magnitude
233	Fault 4 Prefault Phase B Current Angle
234	Fault 4 Prefault Phase C Current Magnitude
235	Fault 4 Prefault Phase C Current Angle
236	Fault 4 Prefault Phase A Voltage Magnitude
237	Fault 4 Prefault Phase A Voltage Angle
238	Fault 4 Prefault Phase B Voltage Magnitude
239	Fault 4 Prefault Phase B Voltage Angle
240	Fault 4 Prefault Phase C Voltage Magnitude
241	Fault 4 Prefault Phase C Voltage Angle
242	Fault 4 Postfault Phase A Current Magnitude
243	Fault 4 Postfault Phase A Current Angle
244	Fault 4 Postfault Phase B Current Magnitude
245	Fault 4 Postfault Phase B Current Angle
246	Fault 4 Postfault Phase C Current Magnitude
247	Fault 4 Postfault Phase C Current Angle
248	Fault 4 Postfault Phase A Voltage Magnitude
249	Fault 4 Postfault Phase A Voltage Angle
250	Fault 4 Postfault Phase B Voltage Magnitude
251	Fault 4 Postfault Phase B Voltage Angle
252	Fault 4 Postfault Phase C Voltage Magnitude
253	Fault 4 Postfault Phase C Voltage Angle
254	Fault 4 Type
255	Fault 4 Location
256	Fault 5 Prefault Phase A Current Magnitude
257	Fault 5 Prefault Phase A Current Angle
258	Fault 5 Prefault Phase B Current Magnitude
259	Fault 5 Prefault Phase B Current Angle

Table D-6: ANALOG INPUT POINTS (Sheet 6 of 6)

POINT	DESCRIPTION
260	Fault 5 Prefault Phase C Current Magnitude
261	Fault 5 Prefault Phase C Current Angle
262	Fault 5 Prefault Phase A Voltage Magnitude
263	Fault 5 Prefault Phase A Voltage Angle
264	Fault 5 Prefault Phase B Voltage Magnitude
265	Fault 5 Prefault Phase B Voltage Angle
266	Fault 5 Prefault Phase C Voltage Magnitude
267	Fault 5 Prefault Phase C Voltage Angle
268	Fault 5 Postfault Phase A Current Magnitude
269	Fault 5 Postfault Phase A Current Angle
270	Fault 5 Postfault Phase B Current Magnitude
271	Fault 5 Postfault Phase B Current Angle
272	Fault 5 Postfault Phase C Current Magnitude
273	Fault 5 Postfault Phase C Current Angle
274	Fault 5 Postfault Phase A Voltage Magnitude
275	Fault 5 Postfault Phase A Voltage Angle
276	Fault 5 Postfault Phase B Voltage Magnitude
277	Fault 5 Postfault Phase B Voltage Angle
278	Fault 5 Postfault Phase C Voltage Magnitude
279	Fault 5 Postfault Phase C Voltage Angle
280	Fault 5 Type
281	Fault 5 Location
282	DCMA Inputs 1 Value
283	DCMA Inputs 2 Value
284	DCMA Inputs 3 Value
285	DCMA Inputs 4 Value
286	RTD Inputs 1 Value
287	RTD Inputs 2 Value
288	RTD Inputs 3 Value
289	RTD Inputs 4 Value
290	Tracking Frequency
291	FlexElement 1 Actual
292	FlexElement 2 Actual
293	FlexElement 3 Actual
294	FlexElement 4 Actual
295	FlexElement 5 Actual
296	FlexElement 6 Actual
297	FlexElement 7 Actual
298	FlexElement 8 Actual
299	FlexElement 9 Actual
300	FlexElement 10 Actual
301	FlexElement 11 Actual
302	FlexElement 12 Actual
303	FlexElement 13 Actual
304	FlexElement 14 Actual
305	FlexElement 15 Actual
306	FlexElement 16 Actual
307	Current Setting Group

D

E.1.1 REVISION HISTORY

MANUAL P/N	F35 REVISION	RELEASE DATE	ECO
1601-0106-A1	2.0x	24 December 1999	N/A
1601-0106-A2	2.2x	12 May 2000	URF-018
1601-0106-A3	2.2x	14 June 2000	URF-019
1601-0106-A3a	2.2x	28 June 2000	URF-019a
1601-0106-B1	2.4x	08 September 2000	URF-021
1601-0106-B2	2.4x	03 November 2000	URF-023
1601-0106-B3	2.6x	09 March 2001	URF-026
1601-0106-B4	2.8x	26 September 2001	URF-028
1601-0106-B5	2.9x	03 December 2001	URF-029
1601-0106-B6	2.6x	27 February 2004	URX-120
1601-0106-C1	3.0x	02 July 2002	URF-031
1601-0106-C2	3.1x	30 August 2002	URF-033
1601-0106-C3	3.0x	18 November 2002	URF-035
1601-0106-C4	3.1x	18 November 2002	URF-037
1601-0106-C5	3.0x	11 February 2003	URF-039
1601-0106-C6	3.1x	11 February 2003	URF-041
1601-0106-D1	3.2x	11 February 2003	URF-043
1601-0106-D2	3.2x	02 June 2003	URX-084
1601-0106-E1	3.3x	01 May 2003	URX-080
1601-0106-E2	3.3x	29 May 2003	URX-083
1601-0106-F1	3.4x	10 December 2003	URX-111
1601-0106-F2	3.4x	09 February 2004	URX-115
1601-0106-G1	4.0x	23 March 2004	URX-123
1601-0106-G2	4.0x	17 May 2004	URX-136
1601-0106-H1	4.2x	30 June 2004	URX-145
1601-0106-H2	4.2x	23 July 2004	URX-151
1601-0106-J1	4.4x	15 September 2004	URX-156
1601-0106-J2	4.4x	5 January 2005	URX-173

E.1.2 CHANGES TO THE MANUAL

Table E-1: MAJOR UPDATES FOR F35 MANUAL REVISION J2

PAGE (J1)	PAGE (J2)	CHANGE	DESCRIPTION
Title	Title	Update	Manual part number to 1601-0106-J2
3-19	3-19	Update	Updated RS485 SERIAL CONNECTION diagram to 827757A7

Table E–2: MAJOR UPDATES FOR F35 MANUAL REVISION J1

PAGE (H2)	PAGE (J1)	CHANGE	DESCRIPTION
Title	Title	Update	Manual part number to 1601-0106-J1
5-16	---	Remove	Removed UCA/MMS PROTOCOL sub-section
---	5-16	Add	Added IEC 61850 PROTOCOL sub-section
5-110	5-110	Update	Updated VIRTUAL INPUTS sub-section
B-8	B-8	Update	Updated MODBUS MEMORY MAP for firmware revision 4.4x
C-1	---	Remove	Removed UCA/MMS COMMUNICATIONS appendix

Table E–3: MAJOR UPDATES FOR F35 MANUAL REVISION H2

PAGE (H1)	PAGE (H2)	CHANGE	DESCRIPTION
Title	Title	Update	Manual part number to 1601-0106-H2
3-22	3-22	Update	Updated CHANNEL COMMUNICATION OPTIONS table

Table E–4: MAJOR UPDATES FOR F35 MANUAL REVISION H1

PAGE (G2)	PAGE (H1)	CHANGE	DESCRIPTION
Title	Title	Update	Manual part number to 1601-0106-H1
1-12	1-13	Update	Updated COMMISSIONING section
2-3	2-3	Update	Updated F35 ORDER CODES table
2-5	2-5	Update	Updated PROTECTION ELEMENTS section to include Breaker Arcing Current specifications
3-10	3-10	Update	Updated FORM-A CONTACT FUNCTIONS diagram to 827821A5
5-13	5-14	Update	Updated DNP PROTOCOL sub-section to reflect new settings
5-53	5-54	Update	Updated FLEXLOGIC™ OPERANDS table to reflect new features
---	5-102	Add	Added DIGITAL COUNTERS section
---	5-106	Add	Added BREAKER ARCING CURRENT section
---	6-5	Add	Added DIGITAL COUNTERS section
---	6-20	Add	Added BREAKER MAINTENANCE section
B-8	B-8	Update	Updated MODBUS MEMORY MAP for firmware release 4.2x

Table E–5: MAJOR UPDATES FOR F35 MANUAL REVISION G2

PAGE (G1)	PAGE (G2)	CHANGE	DESCRIPTION
Title	Title	Update	Manual part number to 1601-0106-G2
3-6	3-6	Update	Updated TYPICAL WIRING DIAGRAM to 832767A2

Table E–6: MAJOR UPDATES FOR F35 MANUAL REVISION G1 (Sheet 1 of 2)

PAGE (F2)	PAGE (G1)	CHANGE	DESCRIPTION
Title	Title	Update	Manual part number to 1601-0106-G1

Table E-6: MAJOR UPDATES FOR F35 MANUAL REVISION G1 (Sheet 2 of 2)

PAGE (F2)	PAGE (G1)	CHANGE	DESCRIPTION
2-3	2-3	Update	Updated F35 ORDER CODES table
2-4	2-4	Update	Updated ORDER CODES FOR REPLACEMENT MODULES table
2-6	2-6	Add	Added 8-bit switch specifications to the USER-PROGRAMMABLE ELEMENTS section
2-9	2-9	Add	Added dcmA outputs specifications to OUTPUTS section
2-9	2-9	Add	Added IRIG-B outputs specifications to OUTPUTS section
3-4	3-4	Update	Updated MODULE WITHDRAWAL AND INSERTION section to reflect new hardware
3-7	3-7	Update	Updated DIELECTRIC STRENGTH section
3-8	3-8	Update	Updated CT/VT MODULES section for new hardware
3-16	3-16	Update	Updated drawings and description in TRANSDUCER INPUTS/OUTPUTS section
3-17	3-18	Update	Updated drawings and description in CPU COMMUNICATIONS PORTS section
3-19	3-20	Update	Updated IRIG-B section to indicate updated functionality
5-17	5-	Add	Added EGD PROTOCOL sub-section for Ethernet Global Data protocol
5-17	5-	Update	Updated REAL TIME CLOCK section
5-17	5-	Add	Added FAULT REPORTS section
5-50	5-53	Update	Updated FLEXLOGIC™ OPERANDS table
5-61	5-64	Update	Updated FLEXELEMENT™ SCHEME LOGIC diagram to 842004A3
5-62	5-65	Update	Updated FLEXELEMENT™ INPUT MODE SETTING diagram to 842706A2
5-97	5-101	Add	Added 8-BIT SWITCH section
5-112	5-117	Add	Added DCMA OUTPUTS section
6-6	6-7	Add	Added EGD PROTOCOL STATUS section
6-10	6-11	Add	Added voltage harmonics and THD values to the SOURCES section
6-15	6-17	Add	Added FAULT REPORTS section
B-8	B-8	Update	Updated MODBUS MEMORY MAP for firmware release 4.0x

E.2.1 STANDARD ABBREVIATIONS

A.....	Ampere	FREQ.....	Frequency
AC.....	Alternating Current	FSK.....	Frequency-Shift Keying
A/D.....	Analog to Digital	FTP.....	File Transfer Protocol
AE.....	Accidental Energization, Application Entity	FxE.....	FlexElement™
AMP.....	Ampere	FWD.....	Forward
ANG.....	Angle		
ANSI.....	American National Standards Institute	G.....	Generator
AR.....	Automatic Reclosure	GE.....	General Electric
ASDU.....	Application-layer Service Data Unit	GND.....	Ground
ASYM.....	Asymmetry	GNTR.....	Generator
AUTO.....	Automatic	GOOSE.....	General Object Oriented Substation Event
AUX.....	Auxiliary	GPS.....	Global Positioning System
AVG.....	Average		
		HARM.....	Harmonic / Harmonics
BER.....	Bit Error Rate	HCT.....	High Current Time
BF.....	Breaker Fail	HGF.....	High-Impedance Ground Fault (CT)
BFI.....	Breaker Failure Initiate	HIZ.....	High-Impedance and Arcing Ground
BKR.....	Breaker	HMI.....	Human-Machine Interface
BLK.....	Block	HTTP.....	Hyper Text Transfer Protocol
BLKG.....	Blocking	HYB.....	Hybrid
BPNT.....	Breakpoint of a characteristic		
BRKR.....	Breaker	I.....	Instantaneous
		I ₀	Zero Sequence current
CAP.....	Capacitor	I ₁	Positive Sequence current
CC.....	Coupling Capacitor	I ₂	Negative Sequence current
CCVT.....	Coupling Capacitor Voltage Transformer	IA.....	Phase A current
CFG.....	Configure / Configurable	IAB.....	Phase A minus B current
.CFG.....	Filename extension for oscillography files	IB.....	Phase B current
CHK.....	Check	IBC.....	Phase B minus C current
CHNL.....	Channel	IC.....	Phase C current
CLS.....	Close	ICA.....	Phase C minus A current
CLSD.....	Closed	ID.....	Identification
CMND.....	Command	IED.....	Intelligent Electronic Device
CMPRSN.....	Comparison	IEC.....	International Electrotechnical Commission
CO.....	Contact Output	IEEE.....	Institute of Electrical and Electronic Engineers
COM.....	Communication	IG.....	Ground (not residual) current
COMM.....	Communications	Igd.....	Differential Ground current
COMP.....	Compensated, Comparison	IN.....	CT Residual Current (3I ₀) or Input
CONN.....	Connection	INC SEQ.....	Incomplete Sequence
CONT.....	Continuous, Contact	INIT.....	Initiate
CO-ORD.....	Coordination	INST.....	Instantaneous
CPU.....	Central Processing Unit	INV.....	Inverse
CRC.....	Cyclic Redundancy Code	I/O.....	Input/Output
CRT, CRNT.....	Current	IOC.....	Instantaneous Overcurrent
CSA.....	Canadian Standards Association	IOV.....	Instantaneous Overvoltage
CT.....	Current Transformer	IRIG.....	Inter-Range Instrumentation Group
CVT.....	Capacitive Voltage Transformer	ISO.....	International Standards Organization
		IUV.....	Instantaneous Undervoltage
D/A.....	Digital to Analog		
DC (dc).....	Direct Current	K0.....	Zero Sequence Current Compensation
DD.....	Disturbance Detector	kA.....	kiloAmpere
DFLT.....	Default	kV.....	kiloVolt
DGNST.....	Diagnostics		
DI.....	Digital Input	LED.....	Light Emitting Diode
DIFF.....	Differential	LEO.....	Line End Open
DIR.....	Directional	LFT BLD.....	Left Blinder
DISCREP.....	Discrepancy	LOOP.....	Loopback
DIST.....	Distance	LPU.....	Line Pickup
DMD.....	Demand	LRA.....	Locked-Rotor Current
DNP.....	Distributed Network Protocol	LTC.....	Load Tap-Changer
DPO.....	Dropout		
DSP.....	Digital Signal Processor	M.....	Machine
dt.....	Rate of Change	mA.....	MilliAmpere
DTT.....	Direct Transfer Trip	MAG.....	Magnitude
DUTT.....	Direct Under-reaching Transfer Trip	MAN.....	Manual / Manually
		MAX.....	Maximum
ENCRMNT.....	Encroachment	MIC.....	Model Implementation Conformance
EPRI.....	Electric Power Research Institute	MIN.....	Minimum, Minutes
.EVT.....	Filename extension for event recorder files	MMI.....	Man Machine Interface
EXT.....	Extension, External	MMS.....	Manufacturing Message Specification
		MRT.....	Minimum Response Time
F.....	Field	MSG.....	Message
FAIL.....	Failure	MTA.....	Maximum Torque Angle
FD.....	Fault Detector	MTR.....	Motor
FDH.....	Fault Detector high-set	MVA.....	MegaVolt-Ampere (total 3-phase)
FDL.....	Fault Detector low-set	MVA_A.....	MegaVolt-Ampere (phase A)
FLA.....	Full Load Current	MVA_B.....	MegaVolt-Ampere (phase B)
FO.....	Fiber Optic	MVA_C.....	MegaVolt-Ampere (phase C)

MVAR.....	MegaVar (total 3-phase)	SAT.....	CT Saturation
MVAR_A.....	MegaVar (phase A)	SBO.....	Select Before Operate
MVAR_B.....	MegaVar (phase B)	SCADA.....	Supervisory Control and Data Acquisition
MVAR_C.....	MegaVar (phase C)	SEC.....	Secondary
MVARH.....	MegaVar-Hour	SEL.....	Select / Selector / Selection
MW.....	MegaWatt (total 3-phase)	SENS.....	Sensitive
MW_A.....	MegaWatt (phase A)	SEQ.....	Sequence
MW_B.....	MegaWatt (phase B)	SIR.....	Source Impedance Ratio
MW_C.....	MegaWatt (phase C)	SNTP.....	Simple Network Time Protocol
MWH.....	MegaWatt-Hour	SRC.....	Source
N.....	Neutral	SSB.....	Single Side Band
N/A, n/a.....	Not Applicable	SSEL.....	Session Selector
NEG.....	Negative	STATS.....	Statistics
NMPLT.....	Nameplate	SUPN.....	Supervision
NOM.....	Nominal	SUPV.....	Supervise / Supervision
NSAP.....	Network Service Access Protocol	SV.....	Supervision, Service
NTR.....	Neutral	SYNC.....	Synchrocheck
		SYNCHCHK.....	Synchrocheck
O.....	Over	T.....	Time, transformer
OC, O/C.....	Overcurrent	TC.....	Thermal Capacity
O/P, Op.....	Output	TCP.....	Transmission Control Protocol
OP.....	Operate	TCU.....	Thermal Capacity Used
OPER.....	Operate	TD MULT.....	Time Dial Multiplier
OPERATG.....	Operating	TEMP.....	Temperature
O/S.....	Operating System	TFTP.....	Trivial File Transfer Protocol
OSI.....	Open Systems Interconnect	THD.....	Total Harmonic Distortion
OSB.....	Out-of-Step Blocking	TMR.....	Timer
OUT.....	Output	TOC.....	Time Overcurrent
OV.....	Overvoltage	TOV.....	Time Overvoltage
OVERFREQ.....	Overfrequency	TRANS.....	Transient
OVLN.....	Overload	TRANSF.....	Transfer
		TSEL.....	Transport Selector
P.....	Phase	TUC.....	Time Undercurrent
PC.....	Phase Comparison, Personal Computer	TUV.....	Time Undervoltage
PCNT.....	Percent	TX (Tx).....	Transmit, Transmitter
PF.....	Power Factor (total 3-phase)		
PF_A.....	Power Factor (phase A)	U.....	Under
PF_B.....	Power Factor (phase B)	UC.....	Undercurrent
PF_C.....	Power Factor (phase C)	UCA.....	Utility Communications Architecture
PFL.....	Phase and Frequency Lock Loop	UDP.....	User Datagram Protocol
PHS.....	Phase	UL.....	Underwriters Laboratories
PICS.....	Protocol Implementation & Conformance Statement	UNBAL.....	Unbalance
PKP.....	Pickup	UR.....	Universal Relay
PLC.....	Power Line Carrier	URC.....	Universal Recloser Control
POS.....	Positive	.URS.....	Filename extension for settings files
POTT.....	Permissive Over-reaching Transfer Trip	UV.....	Undervoltage
PRESS.....	Pressure		
PRI.....	Primary	V/Hz.....	Volts per Hertz
PROT.....	Protection	V_0.....	Zero Sequence voltage
PSEL.....	Presentation Selector	V_1.....	Positive Sequence voltage
pu.....	Per Unit	V_2.....	Negative Sequence voltage
PUIB.....	Pickup Current Block	VA.....	Phase A voltage
PUIT.....	Pickup Current Trip	VAB.....	Phase A to B voltage
PUSHBTN.....	Pushbutton	VAG.....	Phase A to Ground voltage
PUTT.....	Permissive Under-reaching Transfer Trip	VARH.....	Var-hour voltage
PWM.....	Pulse Width Modulated	VB.....	Phase B voltage
PWR.....	Power	VBA.....	Phase B to A voltage
		VBG.....	Phase B to Ground voltage
QUAD.....	Quadrilateral	VC.....	Phase C voltage
		VCA.....	Phase C to A voltage
R.....	Rate, Reverse	VCG.....	Phase C to Ground voltage
RCA.....	Reach Characteristic Angle	VF.....	Variable Frequency
REF.....	Reference	VIBR.....	Vibration
REM.....	Remote	VT.....	Voltage Transformer
REV.....	Reverse	VTFF.....	Voltage Transformer Fuse Failure
RI.....	Reclose Initiate	VTLOS.....	Voltage Transformer Loss Of Signal
RIP.....	Reclose In Progress		
RGT BLD.....	Right Blinder	WDG.....	Winding
ROD.....	Remote Open Detector	WH.....	Watt-hour
RST.....	Reset	w/ opt.....	With Option
RSTR.....	Restrained	WRT.....	With Respect To
RTD.....	Resistance Temperature Detector		
RTU.....	Remote Terminal Unit	X.....	Reactance
RX (Rx).....	Receive, Receiver	XDUCER.....	Transducer
		XFMR.....	Transformer
s.....	second		
S.....	Sensitive	Z.....	Impedance, Zone

GE MULTILIN RELAY WARRANTY

General Electric Multilin Inc. (GE Multilin) warrants each relay it manufactures to be free from defects in material and workmanship under normal use and service for a period of 24 months from date of shipment from factory.

In the event of a failure covered by warranty, GE Multilin will undertake to repair or replace the relay providing the warrantor determined that it is defective and it is returned with all transportation charges prepaid to an authorized service centre or the factory. Repairs or replacement under warranty will be made without charge.

Warranty shall not apply to any relay which has been subject to misuse, negligence, accident, incorrect installation or use not in accordance with instructions nor any unit that has been altered outside a GE Multilin authorized factory outlet.

GE Multilin is not liable for special, indirect or consequential damages or for loss of profit or for expenses sustained as a result of a relay malfunction, incorrect application or adjustment.

For complete text of Warranty (including limitations and disclaimers), refer to GE Multilin Standard Conditions of Sale.

Numerics

10BASE-F
 communications options 3-18
 description 3-19
 interface 3-29
 redundant option 3-18
 settings 5-13
 specifications 2-10

8-BIT SWITCH
 FlexLogic™ operands 5-55
 Modbus registers B-28
 settings 5-105
 specifications 2-6

A

ABBREVIATIONS E-5

AC CURRENT INPUTS 2-8, 3-8, 5-42

AC VOLTAGE INPUTS 2-8, 3-9

ACTIVATING THE RELAY 1-12, 4-11

ACTIVE SETTING GROUP 5-70

ACTUAL VALUES
 maintenance 6-20
 metering 6-8
 product information 6-21
 records 6-17
 status 6-3

ALARM LEDs 5-29

ALTITUDE 2-11

ANSI DEVICE NUMBERS 2-1

APPARENT POWER 2-7, 6-13

APPLICATION EXAMPLES
 breaker trip circuit integrity 5-102
 contact inputs 5-110

APPROVALS 2-11

AR
 see entry for AUTORECLOSE

ARCHITECTURE 5-53

ARCING CURRENT 5-107

AUTORECLOSE
 actual values 6-4
 FlexLogic™ operands 5-55
 logic 5-97, 5-98
 Modbus registers B-14, B-24
 settings 5-94, 5-96
 single shot sequence 5-99
 specifications 2-6

AUXILIARY OVERVOLTAGE
 FlexLogic™ operands 5-55
 logic 5-86
 Modbus registers B-27
 settings 5-86
 specifications 2-5

AUXILIARY UNDERVOLTAGE
 FlexLogic™ operands 5-55
 logic 5-85
 Modbus registers B-28
 settings 5-85
 specifications 2-5

AUXILIARY VOLTAGE CHANNEL 3-9

AUXILIARY VOLTAGE METERING 6-12

B

BANKS 5-6, 5-42, 5-43

BATTERY FAIL 7-4

BINARY INPUT POINTS D-8

BINARY OUTPUT POINTS D-14

BLOCK DIAGRAM 1-3

BLOCK SETTING 5-4

BREAKER ARCING CURRENT
 actual values 6-20
 clearing 5-11, 7-2
 FlexLogic™ operands 5-55
 logic 5-108
 measurement 5-108
 Modbus registers B-13, B-25
 settings 5-107
 specifications 2-5

BREAKER-AND-A-HALF SCHEME 5-6

BRIGHTNESS 5-9

C

C37.94 COMMUNICATIONS 3-30, 3-31

CE APPROVALS 2-11

CHANGES TO F35 MANUAL E-1

CHANGES TO MANUAL E-1, E-2

CHANGES TO THE MANUAL E-2, E-3, E-4

CHANNEL COMMUNICATION 3-22

CHANNELS
 banks 5-42, 5-43

CIRCUIT MONITORING APPLICATIONS 5-100

CLEANING 2-11

CLEAR RECORDS 5-11, 7-1

CLEAR RELAY RECORDS
 Modbus registers B-38
 settings 5-11

CLOCK
 setting date and time 7-2
 settings 5-21

COMMANDS MENU 7-1

COMMUNICATIONS
 10BASE-F 3-18, 3-19, 5-13
 channel 3-22
 connecting to the UR 1-7, 1-8
 CRC-16 error checking B-2
 dnp 5-14, 5-21, D-1
 EGD 5-19
 G.703 3-25
 half duplex B-1
 HTTP 5-17
 IEC 60870-5-104 protocol 5-18
 IEC 61850 5-16, 5-117
 inter-relay communications 2-10
 Modbus 5-13, 5-21, B-1, B-3
 Modbus registers B-17
 network 5-13
 overview 1-10
 RS232 3-17
 RS485 3-18, 3-19, 5-12
 settings 5-13, 5-14, 5-16, 5-18, 5-19, 5-21
 specifications 2-10
 UCA/MMS 5-115, 5-116
 web server 5-17

COMTRADE B-6, B-7

CONDUCTED RFI 2-11

CONTACT INFORMATION.....	1-1	DATE	7-2
CONTACT INPUTS		DCMA INPUTS	6-16
actual values	6-3	Modbus registers.....	B-15, B-25
dry connections	3-15	settings	5-122
FlexLogic™ operands	5-57	specifications	2-8
Modbus registers	B-9, B-14, B-32, B-34	DCMA OUTPUTS	
module assignments	3-11	description	3-16
settings	5-109	Modbus registers.....	B-29
specifications	2-8	settings	5-123
thresholds	5-109	specifications	2-9
wet connections	3-15	DEFINITE TIME CURVE	5-74, 5-82
wiring	3-13	DEMAND	
CONTACT OUTPUTS		Modbus registers.....	B-12, B-20
actual values	6-4	DEMAND METERING	
FlexLogic™ operands	5-57	actual values.....	6-13
Modbus registers	B-9, B-14, B-36	settings	5-26
module assignments	3-11	specifications	2-7
settings	5-112	DEMAND RECORDS	
wiring	3-13	clearing.....	5-11, 7-2
CONTROL ELEMENTS	5-87	DESIGN	1-3
CONTROL POWER		DEVICE ID	5-115
description.....	3-8	DEVICE PROFILE DOCUMENT	D-1
specifications.....	2-9	DIELECTRIC STRENGTH	2-11, 3-7
CONTROL PUSHBUTTONS		DIGITAL COUNTERS	
FlexLogic™ operands	5-55	actual values.....	6-5
Modbus registers	B-37	FlexLogic™ operands	5-55
settings	5-30	logic	5-104
specifications	2-6	Modbus registers.....	B-9, B-32
COUNTERS		settings	5-103
actual values	6-5	DIGITAL ELEMENTS	
settings	5-103	application example.....	5-101
CRC ALARM	5-40	FlexLogic™ operands	5-55
CRC-16 ALGORITHM	B-2	logic	5-100
CRITICAL FAILURE RELAY	2-9, 3-7	Modbus registers.....	B-31
CSA APPROVAL	2-11	settings	5-100
CT BANKS		DIGITAL INPUTS	
settings	5-42	see entry for CONTACT INPUTS	
CT INPUTS	3-9, 5-6, 5-42	DIGITAL OUTPUTS	
CT WIRING	3-9	see entry for CONTACT OUTPUTS	
CURRENT BANK	5-42	DIMENSIONS	3-1
CURRENT DEMAND	5-26	DIRECT DEVICES	
CURRENT HARMONICS	6-14	actual values.....	6-7
CURRENT METERING		Modbus registers.....	B-16
actual values	6-11	settings	5-118
Modbus registers	B-10	DIRECT I/O	
specifications	2-7	see also DIRECT INPUTS and DIRECT OUTPUTS	
CURVES		application example.....	5-119, 5-120
definite time.....	5-74, 5-82	configuration examples.....	5-27, 5-36, 5-40, 5-41
FlexCurves™	5-46, 5-74	settings	5-27, 5-36, 5-40, 5-41, 5-118
I2T	5-74	DIRECT INPUTS	
IAC	5-73	actual values.....	6-6
IEC	5-72	application example.....	5-119, 5-120
IEEE	5-71	clearing counters.....	7-2
inverse time undervoltage	5-82	Modbus registers.....	B-10, B-16, B-38, B-39
types	5-70	settings	5-118
		specifications	2-8
		DIRECT OUTPUTS	
		application example.....	5-119, 5-120
		clearing counters.....	7-2
		Modbus registers.....	B-10, B-38, B-39
		settings	5-119
		DISPLAY	1-10, 4-8, 5-9
		DNA-1 BIT PAIR	5-117
		DNP COMMUNICATIONS	
		binary counters	D-15
		binary input points	D-8
		binary output points	D-14
		control relay output blocks	D-14

D

DATA FORMATS, MODBUS	B-43
DATA LOGGER	
clearing	5-11, 7-1
Modbus	B-7
Modbus registers	B-10, B-18
settings	5-25
specifications	2-7
via COMTRADE	B-6

device profile document	D-1	FACEPLATE PANELS	4-4, 4-7
frozen counters	D-15	FAST FORM-C RELAY	2-9
implementation table	D-4	FAST TRANSIENT TESTING	2-11
Modbus registers	B-17	FAULT LOCATOR	
settings	5-14	logic	6-18
user map	5-16	Modbus registers	B-13
DUPLEX, HALF	B-1	operation	6-17
DYNAMIC SWITCH		specifications	2-7
see entry for 8-BIT SWITCH		FAULT REPORT	
<hr/>			
E		actual values	6-17
EGD PROTOCOL		clearing	5-11, 7-1
actual values	6-7	Modbus registers	B-14, B-18
Modbus registers	B-28	settings	5-22
settings	5-19	FAULT REPORTS	
EIGHT-BIT SWITCH		Modbus registers	B-29
FlexLogic™ operands	5-55	FAULT TYPE	6-17
Modbus registers	B-28	FAX NUMBERS	1-1
settings	5-105	FEATURES	2-1
specifications	2-6	FIRMWARE REVISION	6-21
ELECTROSTATIC DISCHARGE	2-11	FIRMWARE UPGRADES	4-2
ELEMENTS	5-4	FLASH MESSAGES	5-9
ENERGY METERING		FLEX STATE PARAMETERS	
actual values	6-13	actual values	6-5
Modbus registers	B-12	Modbus registers	B-14, B-28
specifications	2-7	settings	5-33
ENERGY METERING, CLEARING	5-11, 7-2	specifications	2-6
ENERVISTA UR SETUP		FLEXANALOG PARAMETER LIST	A-1
creating a site list	4-1	FLEXCURVES™	
event recorder	4-2	equation	5-74
firmware upgrades	4-2	Modbus registers	B-20, B-31
installation	1-5	settings	5-46
introduction	4-1	specifications	2-6
oscillography	4-2	table	5-46
overview	4-1	FLEXELEMENTS™	
requirements	1-5	actual values	6-15
EQUATIONS		direction	5-67
definite time curve	5-74, 5-82	FlexLogic™ operands	5-55
FlexCurve™	5-74	hysteresis	5-67
I ² t curves	5-74	Modbus registers	B-28, B-30
IAC curves	5-73	pickup	5-67
IEC curves	5-72	scheme logic	5-66
IEEE curves	5-71	settings	5-65, 5-66, 5-68
ETHERNET		specifications	2-6
actual values	6-6	FLEXLOGIC™	
configuration	1-7	editing with enerVista UR Setup	4-1
Modbus registers	B-10	equation editor	5-64
settings	5-13	evaluation	5-59
specifications	2-10	example	5-53, 5-60
EVENT CAUSE INDICATORS	4-5	example equation	5-87
EVENT RECORDER		gate characteristics	5-58
actual values	6-19	Modbus registers	B-21
clearing	5-11, 7-1	operands	5-54, 5-55
Modbus	B-7	operators	5-59
Modbus registers	B-15	rules	5-59
specifications	2-7	specifications	2-6
via enerVista software	4-2	timers	5-64
EVENTS SETTING	5-5	worksheet	5-61
EXCEPTION RESPONSES	B-5	FLEXLOGIC™ EQUATION EDITOR	5-64
<hr/>			
F		FLEXLOGIC™ TIMERS	
F485	1-10	Modbus registers	B-21
FACEPLATE	3-1	settings	5-64
		FORCE CONTACT INPUTS	5-127
		FORCE CONTACT OUTPUTS	5-128
		FORCE TRIGGER	6-19
		FORM-A RELAY	
		high impedance circuits	3-11
		outputs	3-10, 3-11, 3-15
		specifications	2-9

FORM-C RELAY
 outputs 3-10, 3-15
 specifications 2-9
 FREQUENCY METERING
 actual values 6-14
 Modbus registers B-12
 settings 5-44
 specifications 2-7
 FREQUENCY TRACKING 5-44, 6-15
 FREQUENCY, NOMINAL 5-43
 FUNCTION SETTING 5-4
 FUSE 2-8

G

G.703 3-24, 3-25, 3-26, 3-29
 GE TYPE IAC CURVES 5-73
 GROUND CURRENT METERING 6-11
 GROUND IOC
 FlexLogic™ operands 5-56
 logic 5-81
 Modbus registers B-24
 settings 5-81
 GROUND TIME OVERCURRENT
 see entry for GROUND TOC
 GROUND TOC
 FlexLogic™ operands 5-56
 logic 5-80
 Modbus registers B-23
 settings 5-80
 specifications 2-5
 GROUPED ELEMENTS 5-70
 GSSE 5-16, 5-115, 5-116, 5-117, 5-118, 6-5, B-17

H

HALF-DUPLEX B-1
 HARMONICS METERING
 specifications 2-7
 HTTP PROTOCOL 5-17
 HUMIDITY 2-11

I

I2T CURVES 5-74
 IAC CURVES 5-73
 IEC 60870-5-104 PROTOCOL
 interoperability document C-1
 Modbus registers B-18
 settings 5-18
 IEC 61850
 device ID 5-115
 DNA2 assignments 5-117
 Modbus registers B-17
 remote device settings 5-115
 remote inputs 5-116
 settings 5-16
 UserSt-1 bit pair 5-118
 IEC CURVES 5-72
 IED 1-2
 IED SETUP 1-5
 IEEE C37.94 COMMUNICATIONS 3-30, 3-31
 IEEE CURVES 5-71
 IMPORTANT CONCEPTS 1-4

IN SERVICE INDICATOR 1-12, 7-3
 INPUTS
 AC current 2-8, 5-42
 AC voltage 2-8, 5-43
 contact inputs 2-8, 3-13, 5-109, 5-127
 dcmA inputs 2-8, 3-16
 direct inputs 2-8
 IRIG-B 2-8, 3-20
 remote inputs 2-8, 5-115, 5-116
 RTD inputs 2-8, 3-16
 virtual 5-111
 INSPECTION CHECKLIST 1-1
 INSTALLATION
 communications 3-18
 contact inputs/outputs 3-11, 3-13, 3-14
 CT inputs 3-9
 RS485 3-19
 settings 5-41
 VT inputs 3-8
 INSTANTANEOUS OVERCURRENT
 see PHASE, GROUND, and NEUTRAL IOC entries
 INSULATION RESISTANCE 2-11
 INTELLIGENT ELECTRONIC DEVICE 1-2
 INTER-RELAY COMMUNICATIONS 2-10
 INTRODUCTION 1-2
 INVERSE TIME UNDERVOLTAGE 5-82
 IOC
 see PHASE, GROUND, and NEUTRAL IOC entries
 IP ADDRESS 5-13
 IRIG-B
 connection 3-20
 settings 5-21
 specifications 2-8, 2-9
 ISO-9000 REGISTRATION 2-11

K

KEYPAD 1-11, 4-8

L

LAMPTEST 7-2
 LASER MODULE 3-23
 LATCHING OUTPUTS
 application example 5-113, 5-114
 settings 5-112
 specifications 2-9
 LED INDICATORS 4-5, 4-6, 4-7, 5-29
 LED TEST
 FlexLogic™ operand 5-57
 settings 5-27
 specifications 2-6
 LINK POWER BUDGET 2-10
 LOGIC GATES 5-59
 LOST PASSWORD 5-8

M

MAINTENANCE COMMANDS 7-2
 MANUFACTURING DATE 6-21
 MEMORY MAP DATA FORMATS B-43
 MENU HEIRARCHY 1-11, 4-9
 MENU NAVIGATION 1-11, 4-8, 4-9
 METERING

- conventions 6-8, 6-9
 - current 2-7
 - demand 2-7
 - frequency 2-7
 - harmonics 2-7
 - power 2-7
 - THD 2-7
 - voltage 2-7
 - METERING CONVENTIONS 6-9
 - MODBUS
 - data logger B-6, B-7
 - event recorder B-7
 - exception responses B-5
 - execute operation B-4
 - flex state parameters 5-33
 - function code 03/04h B-3
 - function code 05h B-4
 - function code 06h B-4
 - function code 10h B-5
 - introduction B-1
 - memory map data formats B-43
 - obtaining files B-6
 - oscillography B-6
 - passwords B-7
 - read/write settings/actual values B-3
 - settings 5-13, 5-21
 - store multiple settings B-5
 - store single setting B-4
 - supported function codes B-3
 - user map 5-21, B-9, B-20
 - MODEL INFORMATION 6-21
 - MODIFICATION FILE NUMBER 6-21
 - MODULES
 - communications 3-18
 - contact inputs/outputs 3-11, 3-13, 3-14
 - CT 3-9
 - CT/VT 3-8, 5-6
 - direct inputs/outputs 3-23
 - insertion 3-4
 - order codes 2-4
 - ordering 2-4
 - power supply 3-7
 - transducer I/O 3-16
 - VT 3-9
 - withdrawal 3-4
 - MONITORING ELEMENTS 5-106
 - MOUNTING 3-1
-
- N**
- NAMEPLATE 1-1
 - NEUTRAL INSTANTANEOUS OVERCURRENT
 - see entry for NEUTRAL IOC
 - NEUTRAL IOC
 - FlexLogic™ operands 5-56
 - logic 5-79
 - Modbus registers B-23
 - settings 5-79
 - specifications 2-5
 - NEUTRAL OVERVOLTAGE
 - FlexLogic™ operands 5-56
 - logic 5-84
 - Modbus registers B-27
 - settings 5-84
 - specifications 2-5
 - NEUTRAL TIME OVERCURRENT
 - see entry for NEUTRAL TOC
 - NEUTRAL TOC
 - FlexLogic™ operands 5-56
 - logic 5-78
 - Modbus registers B-23
 - settings 5-78
 - specifications 2-5
 - NON-VOLATILE LATCHES
 - FlexLogic™ operands 5-56
 - Modbus registers B-31
 - settings 5-69
 - specifications 2-6
-
- O**
- ONE SHOTS 5-59
 - OPERATING TEMPERATURE 2-11
 - OPERATING TIMES 2-5
 - ORDER CODES 2-3, 6-21, 7-2
 - ORDER CODES, UPDATING 7-2
 - ORDERING 2-2, 2-3, 2-4
 - OSCILLATORY TRANSIENT TESTING 2-11
 - OSCILLOGRAPHY
 - actual values 6-19
 - clearing 5-11, 7-1
 - Modbus B-6
 - Modbus registers B-14, B-18
 - settings 5-23
 - specifications 2-7
 - via COMTRADE B-6
 - via enerVista software 4-2
 - OUTPUTS
 - contact outputs 3-11, 3-13, 5-112
 - control power 2-9
 - critical failure relay 2-9
 - Fast Form-C relay 2-9
 - Form-A relay 2-9, 3-10, 3-11, 3-15
 - Form-C relay 2-9, 3-10, 3-15
 - IRIG-B 2-9
 - latching outputs 2-9, 5-112
 - remote outputs 5-117, 5-118
 - virtual outputs 5-114
 - OVERCURRENT CURVE TYPES 5-70
 - OVERCURRENT CURVES
 - definite time 5-74
 - FlexCurves™ 5-74
 - I²T 5-74
 - IAC 5-73
 - IEC 5-72
 - IEEE 5-71
 - OVERVOLTAGE
 - auxiliary 2-5, 5-86
 - neutral 2-5, 5-84
-
- P**
- PANEL CUTOUT 3-1
 - PARITY 5-12
 - PASSWORD SECURITY 5-8
 - PASSWORDS
 - changing 4-12
 - lost password 4-12, 5-8
 - Modbus B-7
 - Modbus registers B-13, B-16
 - overview 1-12

security	5-8
settings	5-8
PC SOFTWARE	
see entry for ENERVISTA UR SETUP	
PERMISSIVE FUNCTIONS	5-82
PER-UNIT QUANTITY	5-4
PHASE ANGLE METERING	6-9
PHASE CURRENT METERING	6-11
PHASE INSTANTANEOUS OVERCURRENT	
see entry for PHASE IOC	
PHASE IOC	
FlexLogic™ operands	5-56
logic	5-77
Modbus registers	B-22
specifications	2-5
PHASE ROTATION	5-44
PHASE TIME OVERCURRENT	
see entry for PHASE TOC	
PHASE TOC	
FlexLogic™ operands	5-56
logic	5-76
Modbus registers	B-22
settings	5-75
specifications	2-5
PHASE UNDERVOLTAGE	
FlexLogic™ operands	5-56
logic	5-83
Modbus registers	B-25
settings	5-83
specifications	2-5
PHONE NUMBERS	1-1
POWER METERING	
Modbus registers	B-11
specifications	2-7
values	6-12
POWER SUPPLY	
description	3-7
low range	2-8
specifications	2-8
POWER SYSTEM	
Modbus registers	B-20
PREFERENCES	
Modbus registers	B-16
PRODUCT INFORMATION	6-21, B-8
PRODUCT SETUP	5-8
PRODUCTION TESTS	2-11
PROTECTION ELEMENTS	5-4
PU QUANTITY	5-4
PUSHBUTTONS, USER-PROGRAMMABLE	
see USER-PROGRAMMABLE PUSHBUTTONS	

R

REACTIVE POWER	2-7, 6-12
REAL POWER	2-7, 6-12
REAL TIME CLOCK	
Modbus registers	B-18
settings	5-21
REAR TERMINAL ASSIGNMENTS	3-5
RECLOSER CURVES	5-49, 5-74
REDUNDANT 10BASE-F	3-18
RELAY ACTIVATION	4-11
RELAY ARCHITECTURE	5-53
RELAY MAINTENANCE	7-2
RELAY NAME	5-41
RELAY NOT PROGRAMMED	1-12

REMOTE DEVICES	
actual values	6-4
device ID	5-115
FlexLogic™ operands	5-57
Modbus registers	B-9, B-14, B-40
settings	5-115
statistics	6-5
REMOTE INPUTS	
actual values	6-3
FlexLogic™ operands	5-57
Modbus registers	B-9, B-14, B-40
settings	5-116
specifications	2-8
REMOTE OUTPUTS	
DNA-1 bit pair	5-117
Modbus registers	B-41, B-42
UserSt-1 bit pair	5-118
REPLACEMENT MODULES	2-4
RESETTING	5-57, 5-118
REVISION HISTORY	E-1
RFI SUSCEPTIBILITY	2-11
RFI, CONDUCTED	2-11
RMS CURRENT	2-7
RMS VOLTAGE	2-7
ROLLING DEMAND	5-27
RS232	
configuration	1-8
specifications	2-10
wiring	3-17
RS422	
configuration	3-26
timing	3-28
two-channel application	3-27
with fiber interface	3-29
RS485	
communications	3-18
description	3-19
specifications	2-10
RTD INPUTS	
actual values	6-16
Modbus registers	B-15, B-26
settings	5-123
specifications	2-8

S

SALES OFFICE	1-1
SCAN OPERATION	1-4
SELECTOR SWITCH	
actual values	6-5
application example	5-92
FlexLogic™ operands	5-57
logic	5-92
Modbus registers	B-30
settings	5-88
specifications	2-6
timing	5-90, 5-91
SELF-TESTS	
description	7-3
error messages	7-4
FlexLogic™ operands	5-58
Modbus registers	B-8
SERIAL NUMBER	6-21
SERIAL PORTS	
Modbus registers	B-17
settings	5-12

SETTING GROUPS 5-57, 5-70, 5-87, B-30
 SETTINGS, CHANGING 4-10
 SIGNAL SOURCES
 description 5-5
 metering 6-11
 SIGNAL TYPES 1-3
 SINGLE LINE DIAGRAM 2-1, 2-2
 SITE LIST, CREATING 4-1
 SNTP PROTOCOL
 Modbus registers B-18
 settings 5-19
 SOFTWARE
 installation 1-5
 see entry for ENERVISTA UR SETUP
 SOFTWARE ARCHITECTURE 1-4
 SOFTWARE, PC
 see entry for enerVista UR Setup
 SOURCE FREQUENCY 6-14
 SOURCE TRANSFER SCHEMES 5-82
 SOURCES
 description 5-5
 example use of 5-45
 metering 6-11
 Modbus registers B-20
 settings 5-44
 SPECIFICATIONS 2-5
 ST TYPE CONNECTORS 3-19
 STANDARD ABBREVIATIONS E-5
 STATUS INDICATORS 4-5
 SURGE IMMUNITY 2-11
 SYMMETRICAL COMPONENTS METERING 6-9
 SYSTEM FREQUENCY 5-43
 SYSTEM SETUP 5-42

T

TARGET MESSAGES 7-3
 TARGET SETTING 5-5
 TARGETS MENU 7-3
 TCP PORT NUMBER 5-17
 TEMPERATURE, OPERATING 2-11
 TERMINALS 3-5
 TESTING
 force contact inputs 5-127
 force contact outputs 5-128
 lamp test 7-2
 self-test error messages 7-3
 THD
 Modbus registers B-13
 THD METERING 2-7, 6-14
 analog channel correspondence 5-25
 THERMAL DEMAND CHARACTERISTIC 5-26
 TIME 7-2
 TIME OVERCURRENT
 see PHASE, NEUTRAL, and GROUND TOC entries
 TIMERS 5-64
 TOC
 ground 5-80
 neutral 5-78
 phase 5-75
 specifications 2-5
 TRACKING FREQUENCY 6-15, B-28
 TRANSDUCER I/O
 actual values 6-16
 settings 5-122, 5-123
 specifications 2-8

wiring 3-16
 TRIP LEDs 5-29
 TROUBLE INDICATOR 1-12, 7-3
 TYPE TESTS 2-11
 TYPICAL WIRING DIAGRAM 3-6

U

UL APPROVAL 2-11
 UNAUTHORIZED ACCESS
 commands 5-11
 resetting 7-2
 UNDERFREQUENCY
 FlexLogic™ operands 5-57
 logic 5-93
 Modbus registers B-27
 settings 5-93
 specifications 2-5
 UNDERVOLTAGE
 auxiliary 2-5
 phase 2-5, 5-83
 UNDERVOLTAGE CHARACTERISTICS 5-82
 UNIT NOT PROGRAMMED 5-41
 UNPACKING THE RELAY 1-1
 UNRETURNED MESSAGES ALARM 5-41
 UPDATING ORDER CODE 7-2
 URPC
 see entry for ENERVISTA UR SETUP
 USER-DEFINABLE DISPLAYS
 example 5-35
 invoking and scrolling 5-34
 Modbus registers B-16, B-20
 settings 5-34, 5-35
 specifications 2-6
 USER-PROGRAMMABLE LEDs 4-7
 custom labeling 4-6
 defaults 4-6
 description 4-6
 Modbus registers B-18
 settings 5-29
 specifications 2-6
 USER-PROGRAMMABLE PUSHBUTTONS
 FlexLogic™ operands 5-58
 Modbus registers B-21
 settings 5-32
 specifications 2-6
 USER-PROGRAMMABLE SELF TESTS
 Modbus registers B-19
 settings 5-30
 USERST-1 BIT PAIR 5-118

V

VAR-HOURS 2-7, 6-13
 VIBRATION TESTING 2-11
 VIRTUAL INPUTS
 actual values 6-3
 commands 7-1
 FlexLogic™ operands 5-57
 logic 5-111
 Modbus registers B-8, B-34
 settings 5-111
 VIRTUAL OUTPUTS
 actual values 6-4
 FlexLogic™ operands 5-57

INDEX

Modbus registers	B-35
settings	5-114
VOLTAGE BANKS	5-43
VOLTAGE DEVIATIONS	2-11
VOLTAGE ELEMENTS	5-82
VOLTAGE HARMONICS	6-14
VOLTAGE METERING	
Modbus registers	B-11
specifications	2-7
values	6-11
VOLTAGE RESTRAINT CHARACTERISTIC	5-75
VT INPUTS	3-9, 5-6, 5-43
VT WIRING	3-9

W

WARRANTY	E-8
WATT-HOURS	2-7, 6-13
WEB SERVER PROTOCOL	5-17
WEBSITE	1-1
WIRING DIAGRAM	3-6

Z

ZERO SEQUENCE CORE BALANCE	3-9
----------------------------------	-----