

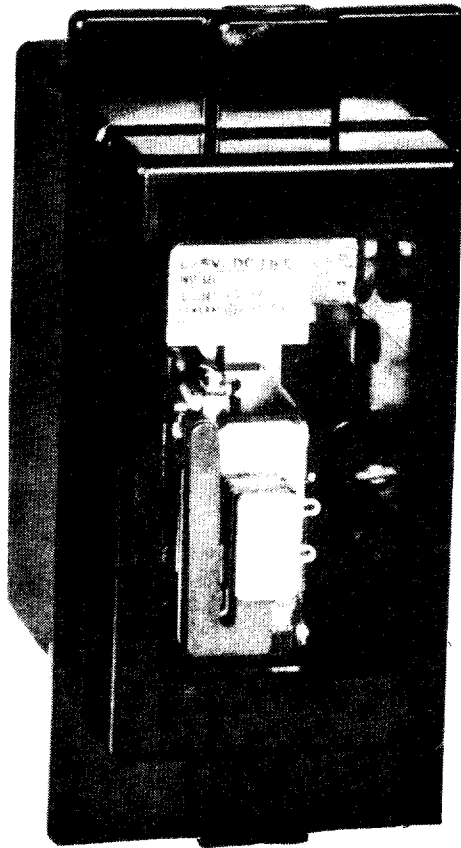

D C STEPPING RELAY

TYPE NLA15A



These instructions do not purport to cover all details or variations in equipment nor to provide for every possible contingency to be met in connection with installation, operation or maintenance. Should further information be desired or should particular problems arise which are not covered sufficiently for the purchaser's purposes, the matter should be referred to the General Electric Company.

To the extent required the products described herein meet applicable ANSI, IEEE and NEMA standards; but no such assurance is given with respect to local codes and ordinances because they vary greatly.

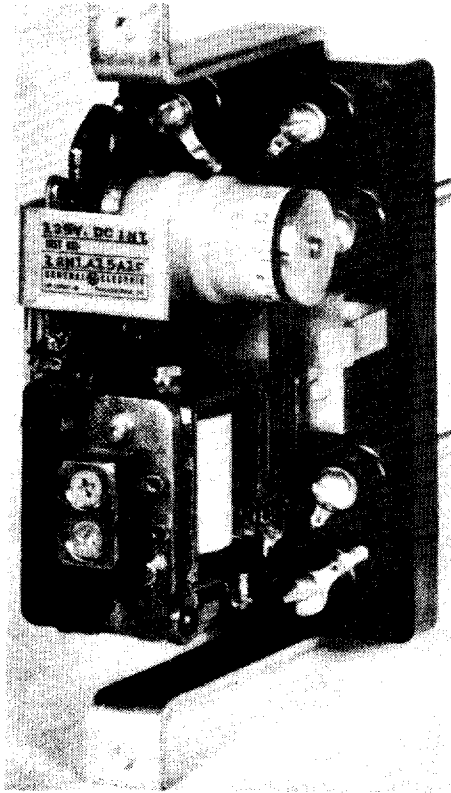

Fig. 1A (8031676) Relay Type NLA15A Removed from Case

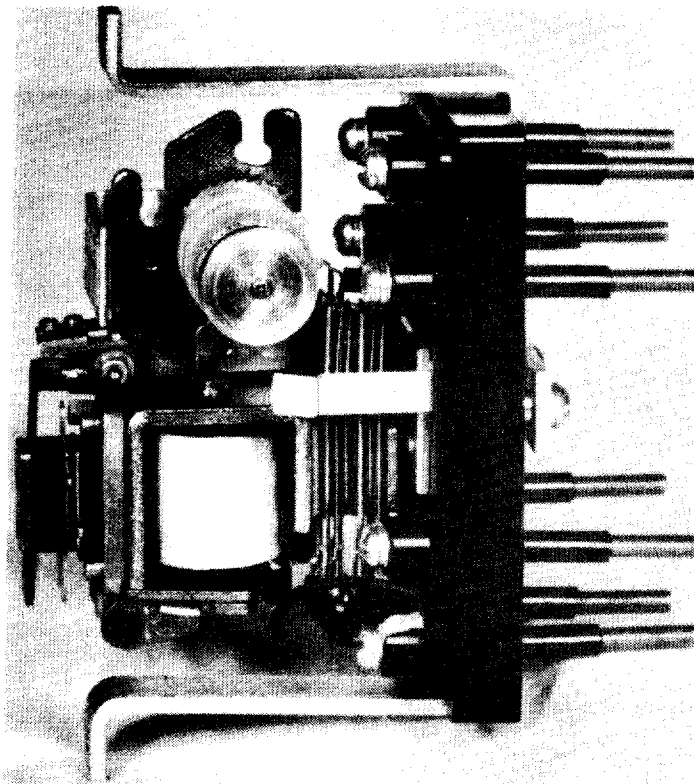

Fig. 1B (8031677) Relay Type NLA15A Removed from Case (Right Side View)

DC STEPPING RELAY

TYPE NLA15A

DESCRIPTION

The NLA15A relay is a counting device which closes an alarm contact after a certain number of operations (adjustable from 4 to 35) and opens two other contacts (lockout contacts) after a preselected number of subsequent operations.

The basic element of the NLA relay is a notching telephone type unit equipped with a numbered dial, visible from the front of the relay which indicates the number of operations remaining before lockout. The relay is mounted in a small molded case whose cover has a glass window. The relay is available for either flush or surface mounting and the outline and panel drilling is shown in Figs. 4 and 5.

APPLICATION

The NLA relay was designed to be used to count the automatic reclosing operations of a circuit breaker but it can be adapted for other notching or sequencing functions. In its usual application the relay sounds an alarm after a preselected number of operations and locks out the automatic reclosing circuit after a certain number of subsequent operations. (See Fig. 2 for typical connections). The NLA15A1 relay is set for 3 operations between alarm and lockout and the NLA15A2 is set for 4 operations but other settings can be provided if required.

The relay can be reset to zero from any point in its cycle by repeated operations of a remote push button or of the relay armature with the relay cover removed. The cam assembly carries a numbered dial visible thru the cover showing the steps remaining to lockout.

The relay is designed for D.C. operation. A full-wave rectifier is required if the relay is to be operated from an A.C. source.

It may be desirable to use blocking rectifiers to eliminate manual closures from the NLA relay count. Since the manual closures are not usually preceded by severe interrupting duty the elimination of these in establishing the number of breaker operations before an alarm is normally beneficial. If the operating coil of the NLA relay is connected in the trip circuit, a blocking rectifier can be used to isolate all tripouts from the NLA relay count except those initiated by high set instantaneous relays. This permits the NLA relay to count the

number of severe interruptions the breaker has made before it sounds an alarm.

RATING

The NLA relay is available with intermittent operating coil ratings of 24 to 250 volts DC and auxiliary devices to permit AC operation is available upon request.

The contacts will make and carry 30 amperes momentarily and the interrupting ability for each contact for normal repetitive protective duty is given in Table A.

TABLE A

VOLTS	INTERRUPTION AMPS
48 DC	1.0
125 DC	0.5
250 DC	0.25
115-60 Cyc.	0.75
230-60 Cyc.	0.5

The resistance of the operating coils is shown in Fig. 3.

CHARACTERISTIC

The NLA15 relay has a total of 36 steps. Each operation rotates the cam 10 degrees and the numbered dial indicates the number of operations remaining to the lockout position which is numbered 0. The cam determines the number of operations between alarm and lockout which is 3 or 4 on the standard relay and this leaves 33 or 32 from lockout to alarm. If some other number of operations between lockout and alarm is desired then at lockout the relay must be operated either manually or by remote push button enough times to step the relay to the point where the desired number of operations to alarm remains.

RECEIVING, HANDLING AND STORAGE

These relays, when not included as part of a control panel, will be shipped in cartons designed to protect them against damage. Immediately upon receipt of a relay, examine it for any damage sustained in transit. If injury or damage resulting from rough handling is evident, file a damage claim

at once with the transportation company and promptly notify the nearest General Electric Apparatus Sales Office.

Reasonable care should be exercised in unpacking the relay. If the relays are not to be installed immediately, they should be stored in their original cartons in a place that is free from moisture, dust and metallic chips. Foreign matter collected on the outside of the case may find its way inside when the cover is removed and cause trouble in the operation of the relay.

Also check the nameplate stamping to insure that the model number and the rating of the relay received agree with the requisition.

ADJUSTMENT AND INSPECTION

Check that the pointer is set on zero when lockout contact is closed.

Before installation, the relay should be checked mechanically to see that it operates smoothly and that the contacts are correctly adjusted.

With the relay deenergized each normally open contact should have a gap of .010" or more. Observe the wipe on each normally closed contact by deflecting the stationary contact member slightly. Wipe should be .005" or more.

Check that the wipe on each normally open contact is at least .005" and that the normally closed contact gap is .010" or more.

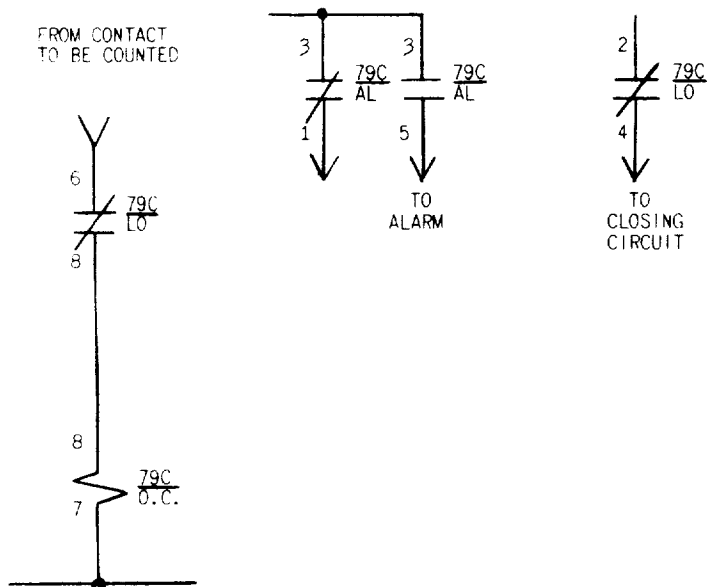

Fig. 2 (0165A7640-0) External Connection Diagram for the NLA15A Relay

Electrical Test

The relay should be tested before installation and periodically thereafter by connecting a variable source of voltage to the coil studs and checking that the pick-up voltage is 80% or less of rating. When checking relay pick up, the relay operating coil should be energized only for a short time to prevent overheating.

SERVICING

For cleaning relay contacts a flexible burnishing tool should be used. This consists of an etched roughened strip of flexible metal, resembling a superfine file which removes corroded material quickly without scratching the surface. The flexibility of the tool insures the cleaning of the actual points of contact. Never use knives, files, abrasive paper or cloth to clean relay contacts. A burnishing tool as described above can be obtained from the factory.

RENEWAL PARTS

It is recommended that sufficient quantities of renewal parts be carried in stock to enable the prompt replacement of any that are worn, broken, or damaged.

When ordering renewal parts, address the nearest Sales Office of the General Electric Company, specify quantity required, name of the part wanted, and give complete nameplate data. If possible, give the General Electric requisition number on which the relay was furnished.

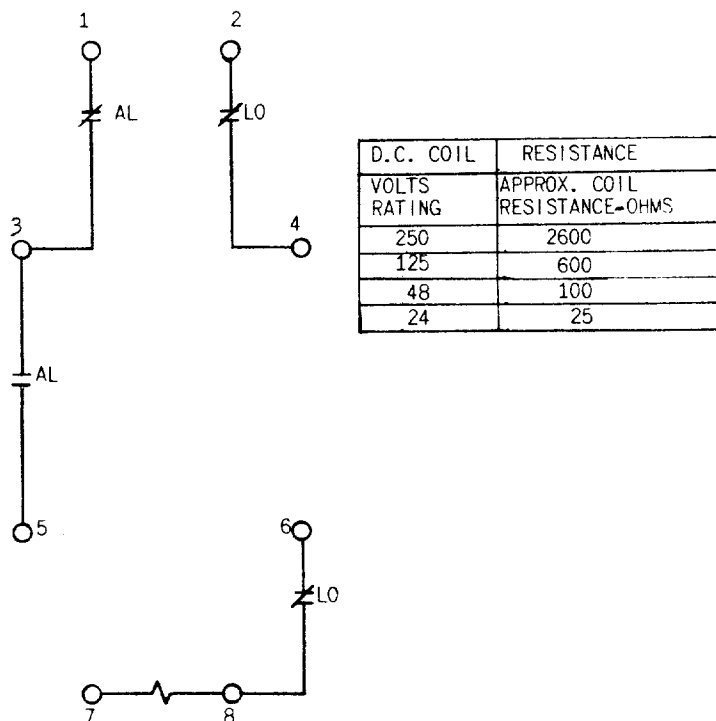

Fig. 3 (0165A7604-1) Internal Connection Diagram (Back View) of the NLA15A Relay

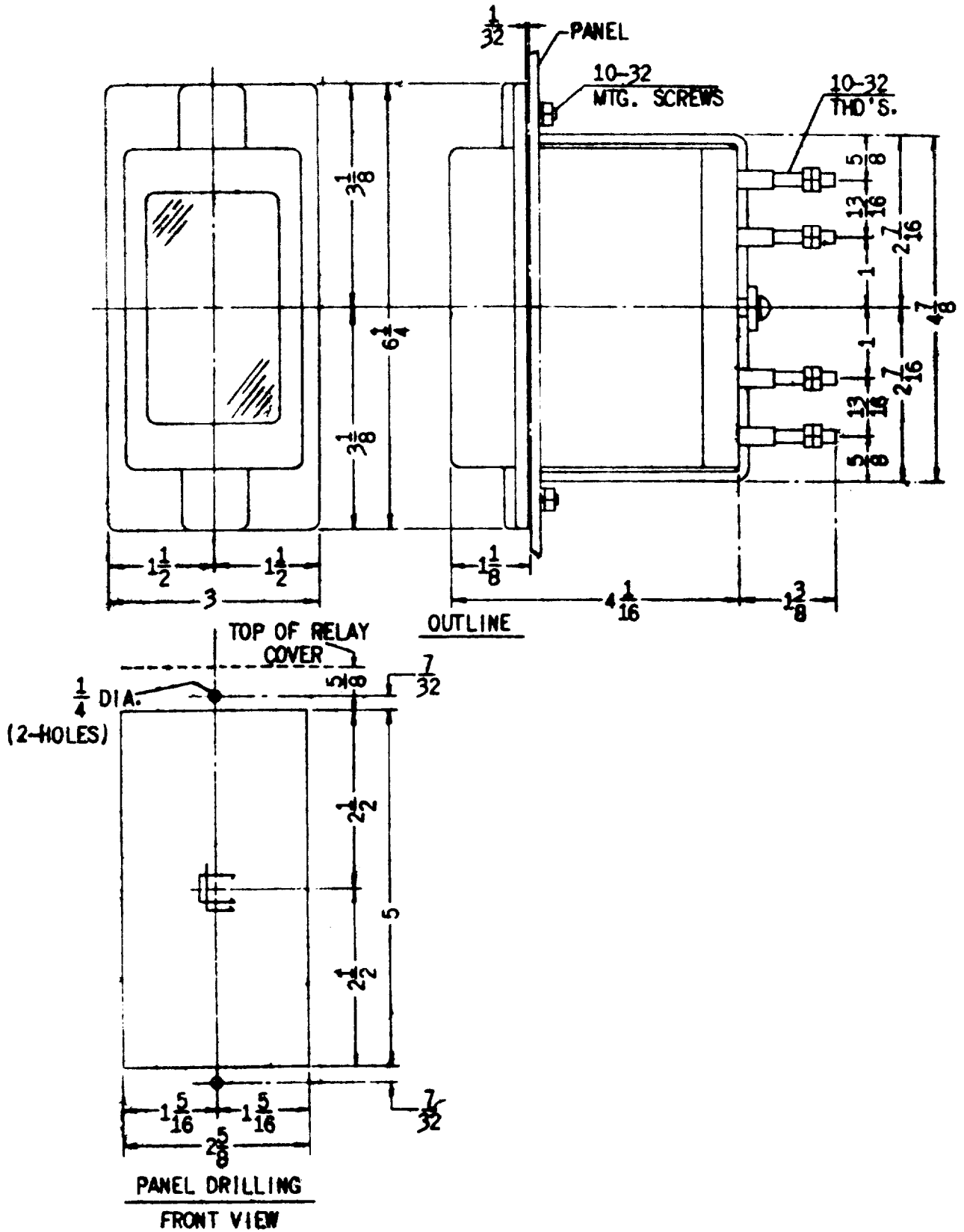
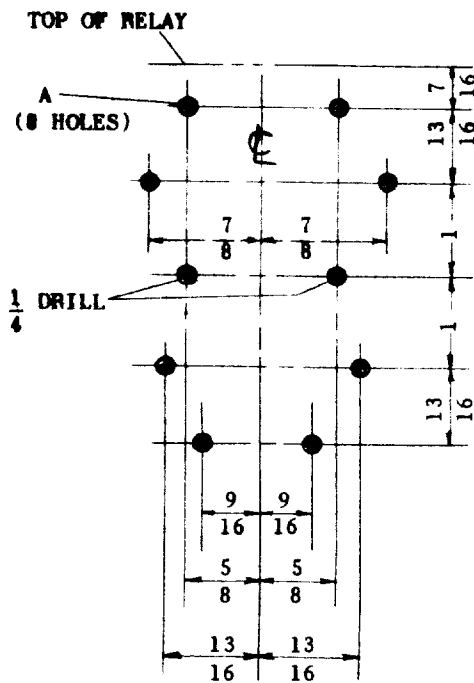
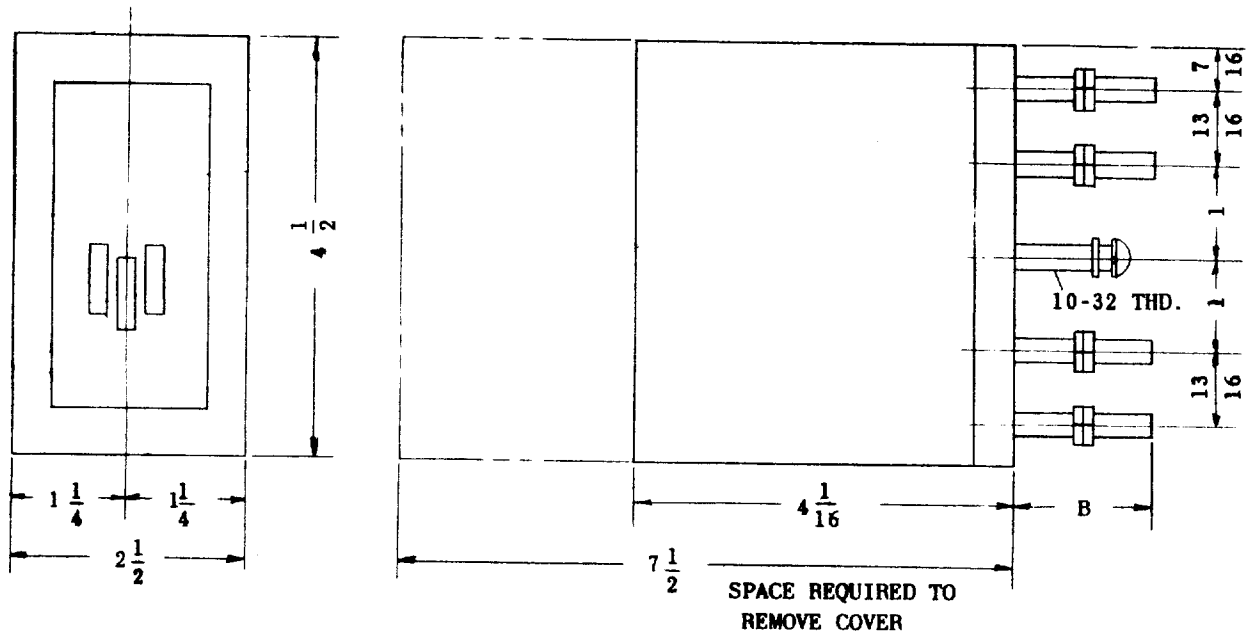

Fig. 4 (0148A3978-2) Outline and Panel Drilling Dimensions for the Semi-flush Mounted NLA15A Relay



OUTLINE

TYPE OF PANEL	A	B
INSULATING	7/16	2 - 13/16
STEEL	9/16	1 - 3/8

PANEL DRILLING (FRONT VIEW)

Fig. 5 (0148A3979-2) Outline and Drilling Dimensions for the Projection Mounted NLA15A Relay



GE Power Management

**215 Anderson Avenue
Markham, Ontario
Canada L6E 1B3
Tel: (905) 294-6222
Fax: (905) 201-2098
www.ge.com/indsys/pm**