



T60 Transformer Management Relay UR Series Instruction Manual

T60 Revision: 4.8x

Manual P/N: 1601-0090-L2 (GEK-113059A)

Copyright © 2006 GE Multilin



GE Multilin

215 Anderson Avenue, Markham, Ontario
Canada L6E 1B3

Tel: (905) 294-6222 Fax: (905) 201-2098

Internet: <http://www.GEindustrial.com/multilin>



GE Multilin's Quality Management System is registered to ISO9001:2000
QMI # 005094
UL # A3775



ADDENDUM

This Addendum contains information that relates to the T60 Transformer Management Relay relay, version 4.8x. This addendum lists a number of information items that appear in the instruction manual GEK-113059A (revision **L2**) but are not included in the current T60 operations.

The following functions/items are not yet available with the current version of the T60 relay:

- Signal Sources SRC 5 and SRC 6

Version 4.0x and higher releases of the T60 relay includes new hardware (CPU and CT/VT modules).

- The new CPU modules are specified with the following order codes: 9E, 9G, 9H, 9J, 9K, 9L, 9M, 9N, 9P, and 9R.
- The new CT/VT modules are specified with the following order codes: 8F, 8G, 8H, 8J.

The following table maps the relationship between the old CPU and CT/VT modules to the newer versions:

MODULE	OLD	NEW	DESCRIPTION
CPU	9A	9E	RS485 and RS485 (Modbus RTU, DNP)
	9C	9G	RS485 and 10Base-F (Ethernet, Modbus TCP/IP, DNP)
	9D	9H	RS485 and redundant 10Base-F (Ethernet, Modbus TCP/IP, DNP)
	--	9J	RS485 and multi-mode ST 100Base-FX
	--	9K	RS485 and multi-mode ST redundant 100Base-FX
	--	9L	RS485 and single mode SC 100Base-FX
	--	9M	RS485 and single mode SC redundant 100Base-FX
	--	9N	RS485 and 10/100Base-T
	--	9P	RS485 and single mode ST 100Base-FX
	--	9R	RS485 and single mode ST redundant 100Base-FX
CT/VT	8A	8F	Standard 4CT/4VT
	8B	8G	Sensitive Ground 4CT/4VT
	8C	8H	Standard 8CT
	8D	8J	Sensitive Ground 8CT/8VT

The new CT/VT modules can only be used with the new CPUs (9E, 9G, 9H, 9J, 9K, 9L, 9M, 9N, 9P, 9R), and the old CT/VT modules can only be used with the old CPU modules (9A, 9C, 9D). To prevent any hardware mismatches, the new CPU and CT/VT modules have blue labels and a warning sticker stating “**Attn.: Ensure CPU and DSP module label colors are the same!**”. In the event that there is a mismatch between the CPU and CT/VT module, the relay will not function and a **DSP ERROR** or **HARDWARE MISMATCH** error will be displayed.

All other input/output modules are compatible with the new hardware.

With respect to the firmware, firmware versions 4.0x and higher are only compatible with the new CPU and CT/VT modules. Previous versions of the firmware (3.4x and earlier) are only compatible with the older CPU and CT/VT modules.

TABLE OF CONTENTS

1. GETTING STARTED	1.1 IMPORTANT PROCEDURES
	1.1.1 CAUTIONS AND WARNINGS 1-1
	1.1.2 INSPECTION CHECKLIST 1-1
	1.2 UR OVERVIEW
	1.2.1 INTRODUCTION TO THE UR 1-2
	1.2.2 HARDWARE ARCHITECTURE 1-3
	1.2.3 SOFTWARE ARCHITECTURE 1-4
	1.2.4 IMPORTANT CONCEPTS 1-4
	1.3 ENERVISTA UR SETUP SOFTWARE
	1.3.1 PC REQUIREMENTS 1-5
	1.3.2 INSTALLATION 1-5
	1.3.3 CONNECTING ENERVISTA UR SETUP WITH THE T60 1-7
	1.4 UR HARDWARE
	1.4.1 MOUNTING AND WIRING 1-10
	1.4.2 COMMUNICATIONS 1-10
	1.4.3 FACEPLATE DISPLAY 1-10
	1.5 USING THE RELAY
	1.5.1 FACEPLATE KEYPAD 1-11
	1.5.2 MENU NAVIGATION 1-11
	1.5.3 MENU HIERARCHY 1-11
	1.5.4 RELAY ACTIVATION 1-12
	1.5.5 RELAY PASSWORDS 1-12
	1.5.6 FLEXLOGIC™ CUSTOMIZATION 1-12
	1.5.7 COMMISSIONING 1-13
2. PRODUCT DESCRIPTION	2.1 INTRODUCTION
	2.1.1 OVERVIEW 2-1
	2.1.2 ORDERING 2-3
	2.2 SPECIFICATIONS
	2.2.1 PROTECTION ELEMENTS 2-6
	2.2.2 USER-PROGRAMMABLE ELEMENTS 2-8
	2.2.3 MONITORING 2-9
	2.2.4 METERING 2-9
	2.2.5 INPUTS 2-10
	2.2.6 POWER SUPPLY 2-11
	2.2.7 OUTPUTS 2-11
	2.2.8 COMMUNICATIONS 2-12
	2.2.9 INTER-RELAY COMMUNICATIONS 2-13
	2.2.10 ENVIRONMENTAL 2-13
	2.2.11 TYPE TESTS 2-14
	2.2.12 PRODUCTION TESTS 2-14
	2.2.13 APPROVALS 2-14
	2.2.14 MAINTENANCE 2-14
3. HARDWARE	3.1 DESCRIPTION
	3.1.1 PANEL CUTOUT 3-1
	3.1.2 MODULE WITHDRAWAL AND INSERTION 3-4
	3.1.3 REAR TERMINAL LAYOUT 3-5
	3.2 WIRING
	3.2.1 TYPICAL WIRING 3-6
	3.2.2 DIELECTRIC STRENGTH 3-7
	3.2.3 CONTROL POWER 3-7
	3.2.4 CT/VT MODULES 3-8
	3.2.5 CONTACT INPUTS/OUTPUTS 3-10
	3.2.6 TRANSDUCER INPUTS/OUTPUTS 3-17
	3.2.7 RS232 FACEPLATE PORT 3-18
	3.2.8 CPU COMMUNICATION PORTS 3-18
	3.2.9 IRIG-B 3-21

TABLE OF CONTENTS

3.3 DIRECT INPUT/OUTPUT COMMUNICATIONS

3.3.1	DESCRIPTION	3-22
3.3.2	FIBER: LED AND ELED TRANSMITTERS	3-24
3.3.3	FIBER-LASER TRANSMITTERS	3-24
3.3.4	G.703 INTERFACE	3-25
3.3.5	RS422 INTERFACE	3-28
3.3.6	RS422 AND FIBER INTERFACE	3-30
3.3.7	G.703 AND FIBER INTERFACE	3-30
3.3.8	IEEE C37.94 INTERFACE	3-31
3.3.9	C37.94SM INTERFACE	3-33

4. HUMAN INTERFACES

4.1 ENERVISTA UR SETUP SOFTWARE INTERFACE

4.1.1	INTRODUCTION	4-1
4.1.2	CREATING A SITE LIST	4-1
4.1.3	SOFTWARE OVERVIEW	4-1
4.1.4	ENERVISTA UR SETUP MAIN WINDOW	4-3

4.2 FACEPLATE INTERFACE

4.2.1	FACEPLATE	4-4
4.2.2	LED INDICATORS	4-5
4.2.3	DISPLAY	4-8
4.2.4	KEYPAD	4-8
4.2.5	MENUS	4-8
4.2.6	CHANGING SETTINGS	4-10

5. SETTINGS

5.1 OVERVIEW

5.1.1	SETTINGS MAIN MENU	5-1
5.1.2	INTRODUCTION TO ELEMENTS	5-3
5.1.3	INTRODUCTION TO AC SOURCES	5-5

5.2 PRODUCT SETUP

5.2.1	PASSWORD SECURITY	5-7
5.2.2	DISPLAY PROPERTIES	5-8
5.2.3	CLEAR RELAY RECORDS	5-10
5.2.4	COMMUNICATIONS	5-11
5.2.5	MODBUS USER MAP	5-22
5.2.6	REAL TIME CLOCK	5-22
5.2.7	USER-PROGRAMMABLE FAULT REPORT	5-22
5.2.8	OSCILLOGRAPHY	5-23
5.2.9	DATA LOGGER	5-26
5.2.10	DEMAND	5-27
5.2.11	USER-PROGRAMMABLE LEDES	5-28
5.2.12	USER-PROGRAMMABLE SELF TESTS	5-32
5.2.13	CONTROL PUSHBUTTONS	5-33
5.2.14	USER-PROGRAMMABLE PUSHBUTTONS	5-34
5.2.15	FLEX STATE PARAMETERS	5-35
5.2.16	USER-DEFINABLE DISPLAYS	5-36
5.2.17	DIRECT INPUTS/OUTPUTS	5-38
5.2.18	TELEPROTECTION	5-43
5.2.19	INSTALLATION	5-44

5.3 SYSTEM SETUP

5.3.1	AC INPUTS	5-45
5.3.2	POWER SYSTEM	5-47
5.3.3	SIGNAL SOURCES	5-48
5.3.4	TRANSFORMER	5-50
5.3.5	FLEXCURVES™	5-62

5.4 FLEXLOGIC™

5.4.1	INTRODUCTION TO FLEXLOGIC™	5-69
5.4.2	FLEXLOGIC™ RULES	5-77
5.4.3	FLEXLOGIC™ EVALUATION	5-77
5.4.4	FLEXLOGIC™ EXAMPLE	5-77
5.4.5	FLEXLOGIC™ EQUATION EDITOR	5-82

TABLE OF CONTENTS

5.4.6	FLEXLOGIC™ TIMERS	5-82
5.4.7	FLEXELEMENTS™	5-83
5.4.8	NON-VOLATILE LATCHES	5-87
5.5 GROUPED ELEMENTS		
5.5.1	OVERVIEW	5-88
5.5.2	SETTING GROUP	5-88
5.5.3	TRANSFORMER ELEMENTS	5-88
5.5.4	PHASE CURRENT	5-96
5.5.5	NEUTRAL CURRENT	5-107
5.5.6	GROUND CURRENT	5-115
5.5.7	VOLTAGE ELEMENTS	5-122
5.6 CONTROL ELEMENTS		
5.6.1	OVERVIEW	5-130
5.6.2	SETTING GROUPS	5-130
5.6.3	SELECTOR SWITCH	5-131
5.6.4	UNDERFREQUENCY	5-137
5.6.5	OVERFREQUENCY	5-138
5.6.6	DIGITAL ELEMENTS	5-139
5.6.7	DIGITAL COUNTERS	5-142
5.6.8	MONITORING ELEMENTS	5-144
5.7 INPUTS/OUTPUTS		
5.7.1	CONTACT INPUTS	5-146
5.7.2	VIRTUAL INPUTS	5-148
5.7.3	CONTACT OUTPUTS	5-149
5.7.4	VIRTUAL OUTPUTS	5-151
5.7.5	REMOTE DEVICES	5-152
5.7.6	REMOTE INPUTS	5-153
5.7.7	REMOTE OUTPUTS	5-154
5.7.8	RESETTING	5-155
5.7.9	DIRECT INPUTS/OUTPUTS	5-155
5.7.10	TELEPROTECTION INPUTS/OUTPUTS	5-159
5.8 TRANSDUCER INPUTS/OUTPUTS		
5.8.1	DCMA INPUTS	5-161
5.8.2	RTD INPUTS	5-162
5.8.3	DCMA OUTPUTS	5-162
5.9 TESTING		
5.9.1	TEST MODE	5-166
5.9.2	FORCE CONTACT INPUTS	5-166
5.9.3	FORCE CONTACT OUTPUTS	5-167

6. ACTUAL VALUES

6.1 OVERVIEW		
6.1.1	ACTUAL VALUES MAIN MENU	6-1
6.2 STATUS		
6.2.1	CONTACT INPUTS	6-3
6.2.2	VIRTUAL INPUTS	6-3
6.2.3	REMOTE INPUTS	6-3
6.2.4	TELEPROTECTION INPUTS	6-4
6.2.5	CONTACT OUTPUTS	6-4
6.2.6	VIRTUAL OUTPUTS	6-4
6.2.7	REMOTE DEVICES	6-5
6.2.8	DIGITAL COUNTERS	6-5
6.2.9	SELECTOR SWITCHES	6-6
6.2.10	FLEX STATES	6-6
6.2.11	ETHERNET	6-6
6.2.12	DIRECT INPUTS	6-7
6.2.13	DIRECT DEVICES STATUS	6-7
6.2.14	EGD PROTOCOL STATUS	6-8
6.2.15	TELEPROTECTION CHANNEL TESTS	6-8
6.3 METERING		
6.3.1	METERING CONVENTIONS	6-9
6.3.2	TRANSFORMER	6-12

TABLE OF CONTENTS

6.3.3	SOURCES	6-13
6.3.4	TRACKING FREQUENCY.....	6-17
6.3.5	FLEXELEMENTS™	6-17
6.3.6	VOLTS PER HERTZ.....	6-17
6.3.7	RESTRICTED GROUND FAULT.....	6-18
6.3.8	TRANSDUCER INPUTS/OUTPUTS.....	6-18
6.4	RECORDS	
6.4.1	USER-PROGRAMMABLE FAULT REPORTS	6-19
6.4.2	EVENT RECORDS	6-19
6.4.3	OSCILLOGRAPHY	6-19
6.4.4	DATA LOGGER.....	6-20
6.4.5	BREAKER MAINTENANCE	6-20
6.5	PRODUCT INFORMATION	
6.5.1	MODEL INFORMATION.....	6-21
6.5.2	FIRMWARE REVISIONS.....	6-21
<hr/>		
7. COMMANDS AND TARGETS	7.1 COMMANDS	
	7.1.1 COMMANDS MENU.....	7-1
	7.1.2 VIRTUAL INPUTS	7-1
	7.1.3 CLEAR RECORDS.....	7-1
	7.1.4 SET DATE AND TIME.....	7-2
	7.1.5 RELAY MAINTENANCE.....	7-2
	7.2 TARGETS	
	7.2.1 TARGETS MENU	7-4
	7.2.2 TARGET MESSAGES.....	7-4
	7.2.3 RELAY SELF-TESTS	7-4
<hr/>		
8. COMMISSIONING	8.1 DIFFERENTIAL CHARACTERISTIC TESTS	
	8.1.1 DESCRIPTION	8-1
	8.2 DIFFERENTIAL CHARACTERISTIC TEST EXAMPLES	
	8.2.1 INTRODUCTION	8-3
	8.2.2 TEST EXAMPLE 1 (DETAILED).....	8-4
	8.2.3 TEST EXAMPLE 2.....	8-9
	8.2.4 TEST EXAMPLE 3.....	8-10
	8.2.5 TEST EXAMPLE 4.....	8-11
	8.3 INRUSH INHIBIT TEST	
	8.3.1 INRUSH INHIBIT TEST PROCEDURE	8-12
	8.4 OVEREXCITATION INHIBIT TEST	
	8.4.1 OVEREXCITATION INHIBIT TEST PROCEDURE	8-13
	8.5 COMMISSIONING TEST TABLES	
	8.5.1 DIFFERENTIAL RESTRAINT TESTS	8-14
	8.5.2 INRUSH INHIBIT TESTS.....	8-14
	8.5.3 OVEREXCITATION INHIBIT TESTS.....	8-15
<hr/>		
A. FLEXANALOG PARAMETERS	A.1 PARAMETER LIST	
<hr/>		
B. MODBUS COMMUNICATIONS	B.1 MODBUS RTU PROTOCOL	
	B.1.1 INTRODUCTION	B-1
	B.1.2 PHYSICAL LAYER	B-1
	B.1.3 DATA LINK LAYER	B-1
	B.1.4 CRC-16 ALGORITHM	B-2

TABLE OF CONTENTS

B.2 MODBUS FUNCTION CODES	
B.2.1 SUPPORTED FUNCTION CODES	B-3
B.2.2 READ ACTUAL VALUES OR SETTINGS (FUNCTION CODE 03/04H)	B-3
B.2.3 EXECUTE OPERATION (FUNCTION CODE 05H)	B-4
B.2.4 STORE SINGLE SETTING (FUNCTION CODE 06H)	B-4
B.2.5 STORE MULTIPLE SETTINGS (FUNCTION CODE 10H)	B-5
B.2.6 EXCEPTION RESPONSES	B-5
B.3 FILE TRANSFERS	
B.3.1 OBTAINING UR FILES VIA MODBUS	B-6
B.3.2 MODBUS PASSWORD OPERATION	B-7
B.4 MEMORY MAPPING	
B.4.1 MODBUS MEMORY MAP	B-8
B.4.2 DATA FORMATS	B-51
<hr/>	
C. IEC 61850 COMMUNICATIONS	
C.1 INTRODUCTION	
C.1.1 OVERVIEW	C-1
C.1.2 COMMUNICATION PROFILES	C-1
C.1.3 MMS PROTOCOL	C-1
C.1.4 PEER-TO-PEER COMMUNICATION	C-1
C.1.5 FILE SERVICES	C-1
C.1.6 COMMUNICATION SOFTWARE UTILITIES	C-2
C.1.7 NON-IEC 61850 DATA	C-2
C.1.8 TCP CONNECTION TIMING	C-2
C.1.9 LOGICAL NODE MMXU DATA MAPPING	C-2
C.1.10 LOGICAL NODE GGIO DATA MAPPING	C-2
C.1.11 OTHER LOGICAL NODE MAPPING	C-2
C.2 ACSIIACSI CONFORMANCE	
C.2.1 ACSII BASIC CONFORMANCE STATEMENT	C-3
C.2.2 ACSII MODELS CONFORMANCE STATEMENT	C-3
C.2.3 ACSII SERVICES CONFORMANCE STATEMENT	C-4
C.3 LOGICAL NODES	
C.3.1 LOGICAL NODES TABLE	C-7
<hr/>	
D. IEC 60870-5-104 COMMS.	
D.1 IEC 60870-5-104 PROTOCOL	
D.1.1 INTEROPERABILITY DOCUMENT	D-1
D.1.2 POINT LIST	D-9
<hr/>	
E. DNP COMMUNICATIONS	
E.1 DEVICE PROFILE DOCUMENT	
E.1.1 DNP V3.00 DEVICE PROFILE	E-1
E.1.2 IMPLEMENTATION TABLE	E-4
E.2 DNP POINT LISTS	
E.2.1 BINARY INPUT POINTS	E-8
E.2.2 BINARY AND CONTROL RELAY OUTPUT	E-9
E.2.3 COUNTERS	E-10
E.2.4 ANALOG INPUTS	E-11
<hr/>	
F. MISCELLANEOUS	
F.1 CHANGE NOTES	
F.1.1 REVISION HISTORY	F-1
F.1.2 CHANGES TO THE T60 MANUAL	F-1
F.2 ABBREVIATIONS	
F.2.1 STANDARD ABBREVIATIONS	F-4
F.3 WARRANTY	

TABLE OF CONTENTS

F.3.1 GE MULTILIN WARRANTY F-6

INDEX

Please read this chapter to help guide you through the initial setup of your new relay.

1.1.1 CAUTIONS AND WARNINGS



Before attempting to install or use the relay, it is imperative that all **WARNINGS** and **CAUTIONS** in this manual are reviewed to help prevent personal injury, equipment damage, and/or downtime.

1.1.2 INSPECTION CHECKLIST

- Open the relay packaging and inspect the unit for physical damage.
- View the rear nameplate and verify that the correct model has been ordered.

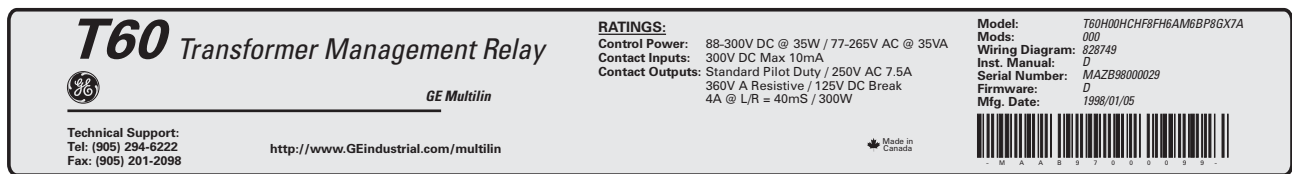

Figure 1-1: REAR NAMEPLATE (EXAMPLE)

- Ensure that the following items are included:
 - Instruction Manual
 - GE enerVista CD (includes the EnerVista UR Setup software and manuals in PDF format)
 - mounting screws
 - registration card (attached as the last page of the manual)
- Fill out the registration form and return to GE Multilin (include the serial number located on the rear nameplate).
- For product information, instruction manual updates, and the latest software updates, please visit the GE Multilin website at <http://www.GEindustrial.com/multilin>.



If there is any noticeable physical damage, or any of the contents listed are missing, please contact GE Multilin immediately.

GE MULTILIN CONTACT INFORMATION AND CALL CENTER FOR PRODUCT SUPPORT:

GE Multilin
 215 Anderson Avenue
 Markham, Ontario
 Canada L6E 1B3

TELEPHONE: (905) 294-6222, 1-800-547-8629 (North America only)

FAX: (905) 201-2098

E-MAIL: gmultilin@indsys.ge.com

HOME PAGE: <http://www.GEindustrial.com/multilin>

1.2.1 INTRODUCTION TO THE UR

Historically, substation protection, control, and metering functions were performed with electromechanical equipment. This first generation of equipment was gradually replaced by analog electronic equipment, most of which emulated the single-function approach of their electromechanical precursors. Both of these technologies required expensive cabling and auxiliary equipment to produce functioning systems.

Recently, digital electronic equipment has begun to provide protection, control, and metering functions. Initially, this equipment was either single function or had very limited multi-function capability, and did not significantly reduce the cabling and auxiliary equipment required. However, recent digital relays have become quite multi-functional, reducing cabling and auxiliaries significantly. These devices also transfer data to central control facilities and Human Machine Interfaces using electronic communications. The functions performed by these products have become so broad that many users now prefer the term IED (Intelligent Electronic Device).

It is obvious to station designers that the amount of cabling and auxiliary equipment installed in stations can be even further reduced, to 20% to 70% of the levels common in 1990, to achieve large cost reductions. This requires placing even more functions within the IEDs.

Users of power equipment are also interested in reducing cost by improving power quality and personnel productivity, and as always, in increasing system reliability and efficiency. These objectives are realized through software which is used to perform functions at both the station and supervisory levels. The use of these systems is growing rapidly.

High speed communications are required to meet the data transfer rates required by modern automatic control and monitoring systems. In the near future, very high speed communications will be required to perform protection signaling with a performance target response time for a command signal between two IEDs, from transmission to reception, of less than 3 milliseconds. This has been established by the IEC 61850 standard.

IEDs with the capabilities outlined above will also provide significantly more power system data than is presently available, enhance operations and maintenance, and permit the use of adaptive system configuration for protection and control systems. This new generation of equipment must also be easily incorporated into automation systems, at both the station and enterprise levels. The GE Multilin Universal Relay (UR) has been developed to meet these goals.

a) UR BASIC DESIGN

The UR is a digital-based device containing a central processing unit (CPU) that handles multiple types of input and output signals. The UR can communicate over a local area network (LAN) with an operator interface, a programming device, or another UR device.

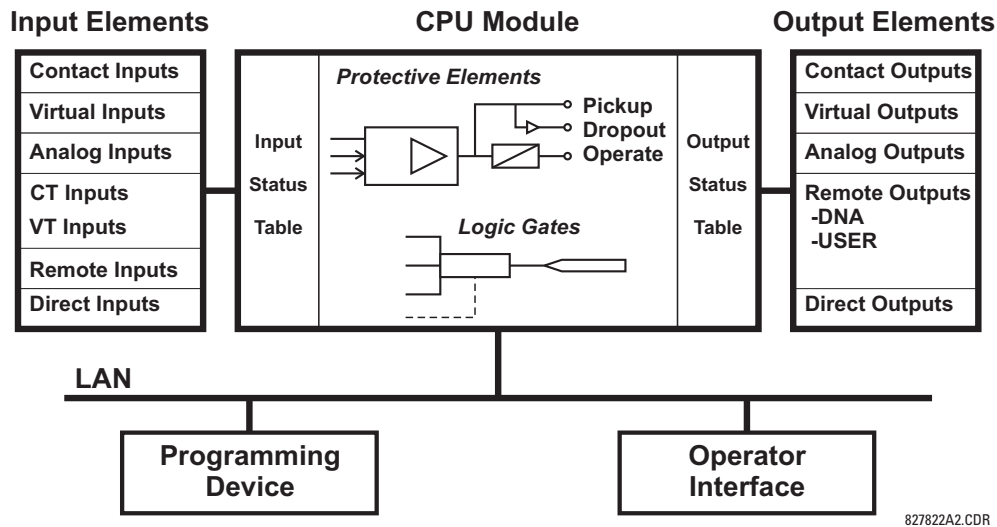

Figure 1-2: UR CONCEPT BLOCK DIAGRAM

The **CPU module** contains firmware that provides protection elements in the form of logic algorithms, as well as programmable logic gates, timers, and latches for control features.

Input elements accept a variety of analog or digital signals from the field. The UR isolates and converts these signals into logic signals used by the relay.

Output elements convert and isolate the logic signals generated by the relay into digital or analog signals that can be used to control field devices.

b) UR SIGNAL TYPES

The **contact inputs and outputs** are digital signals associated with connections to hard-wired contacts. Both 'wet' and 'dry' contacts are supported.

The **virtual inputs and outputs** are digital signals associated with UR-series internal logic signals. Virtual inputs include signals generated by the local user interface. The virtual outputs are outputs of FlexLogic™ equations used to customize the device. Virtual outputs can also serve as virtual inputs to FlexLogic™ equations.

The **analog inputs and outputs** are signals that are associated with transducers, such as Resistance Temperature Detectors (RTDs).

The **CT and VT inputs** refer to analog current transformer and voltage transformer signals used to monitor AC power lines. The UR-series relays support 1 A and 5 A CTs.

The **remote inputs and outputs** provide a means of sharing digital point state information between remote UR-series devices. The remote outputs interface to the remote inputs of other UR-series devices. Remote outputs are FlexLogic™ operands inserted into IEC 61850 GSSE and GOOSE messages.

The **direct inputs and outputs** provide a means of sharing digital point states between a number of UR-series IEDs over a dedicated fiber (single or multimode), RS422, or G.703 interface. No switching equipment is required as the IEDs are connected directly in a ring or redundant (dual) ring configuration. This feature is optimized for speed and intended for pilot-aided schemes, distributed logic applications, or the extension of the input/output capabilities of a single relay chassis.

c) UR SCAN OPERATION

The UR-series devices operate in a cyclic scan fashion. The device reads the inputs into an input status table, solves the logic program (FlexLogic™ equation), and then sets each output to the appropriate state in an output status table. Any resulting task execution is priority interrupt-driven.

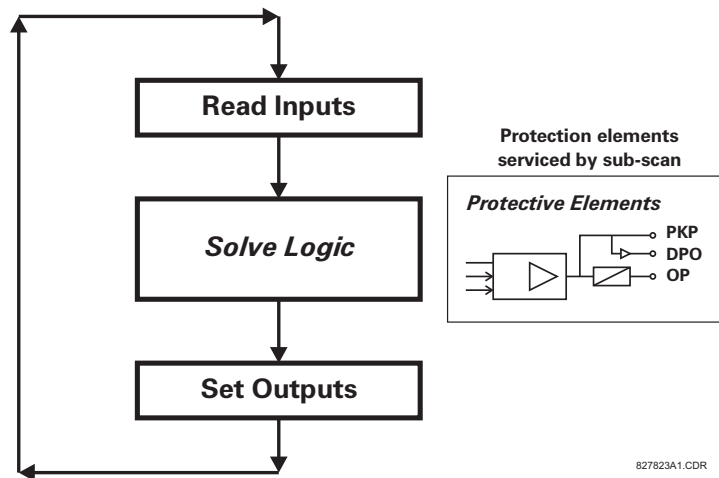

Figure 1-3: UR-SERIES SCAN OPERATION

1.2.3 SOFTWARE ARCHITECTURE

The firmware (software embedded in the relay) is designed in functional modules which can be installed in any relay as required. This is achieved with Object-Oriented Design and Programming (OOD/OOP) techniques.

Object-Oriented techniques involve the use of 'objects' and 'classes'. An 'object' is defined as "a logical entity that contains both data and code that manipulates that data". A 'class' is the generalized form of similar objects. By using this concept, one can create a Protection Class with the Protection Elements as objects of the class such as Time Overcurrent, Instantaneous Overcurrent, Current Differential, Undervoltage, Overvoltage, Underfrequency, and Distance. These objects represent completely self-contained software modules. The same object-class concept can be used for Metering, Input/Output Control, HMI, Communications, or any functional entity in the system.

Employing OOD/OOP in the software architecture of the Universal Relay achieves the same features as the hardware architecture: modularity, scalability, and flexibility. The application software for any Universal Relay (e.g. Feeder Protection, Transformer Protection, Distance Protection) is constructed by combining objects from the various functionality classes. This results in a 'common look and feel' across the entire family of UR-series platform-based applications.

1.2.4 IMPORTANT CONCEPTS

As described above, the architecture of the UR-series relays differ from previous devices. To achieve a general understanding of this device, some sections of Chapter 5 are quite helpful. The most important functions of the relay are contained in "elements". A description of the UR-series elements can be found in the *Introduction to Elements* section in Chapter 5. An example of a simple element, and some of the organization of this manual, can be found in the *Digital Elements* section. An explanation of the use of inputs from CTs and VTs is in the *Introduction to AC Sources* section in Chapter 5. A description of how digital signals are used and routed within the relay is contained in the *Introduction to FlexLogic™* section in Chapter 5.

1.3.1 PC REQUIREMENTS

1

The faceplate keypad and display or the EnerVista UR Setup software interface can be used to communicate with the relay. The EnerVista UR Setup software interface is the preferred method to edit settings and view actual values because the PC monitor can display more information in a simple comprehensible format.

The following minimum requirements must be met for the EnerVista UR Setup software to properly operate on a PC.

- Pentium class or higher processor (Pentium II 300 MHz or higher recommended)
- Windows 95, 98, 98SE, ME, NT 4.0 (Service Pack 4 or higher), 2000, XP
- Internet Explorer 4.0 or higher
- 128 MB of RAM (256 MB recommended)
- 200 MB of available space on system drive and 200 MB of available space on installation drive
- Video capable of displaying 800 x 600 or higher in high-color mode (16-bit color)
- RS232 and/or Ethernet port for communications to the relay

The following qualified modems have been tested to be compliant with the T60 and the EnerVista UR Setup software.

- US Robotics external 56K FaxModem 5686
- US Robotics external Sportster 56K X2
- PCTEL 2304WT V.92 MDC internal modem

1.3.2 INSTALLATION

After ensuring the minimum requirements for using EnerVista UR Setup are met (see previous section), use the following procedure to install the EnerVista UR Setup from the enclosed GE enerVista CD.

1. Insert the GE enerVista CD into your CD-ROM drive.
2. Click the **Install Now** button and follow the installation instructions to install the no-charge enerVista software.
3. When installation is complete, start the enerVista Launchpad application.
4. Click the **IED Setup** section of the **Launch Pad** window.



5. In the enerVista Launch Pad window, click the **Install Software** button and select the “T60 Transformer Management Relay” from the Install Software window as shown below. Select the “Web” option to ensure the most recent software

release, or select "CD" if you do not have a web connection, then click the **Check Now** button to list software items for the T60.

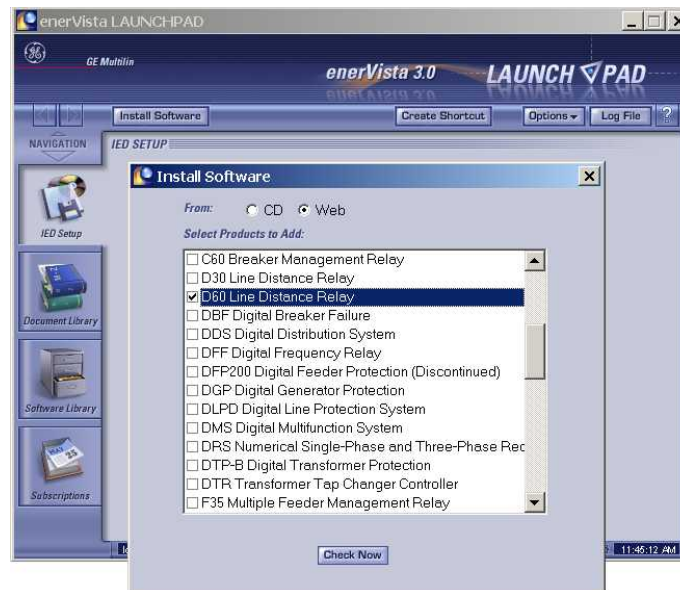

6. Select the T60 software program and release notes (if desired) from the list and click the **Download Now** button to obtain the installation program.



7. enerVista Launchpad will obtain the installation program from the Web or CD. Once the download is complete, double-click the installation program to install the EnerVista UR Setup software.
8. Select the complete path, including the new directory name, where the EnerVista UR Setup will be installed.
9. Click on **Next** to begin the installation. The files will be installed in the directory indicated and the installation program will automatically create icons and add EnerVista UR Setup to the Windows start menu.

10. Click **Finish** to end the installation. The T60 device will be added to the list of installed IEDs in the enerVista Launchpad window, as shown below.



1.3.3 CONNECTING ENERVISTA UR SETUP WITH THE T60

This section is intended as a quick start guide to using the EnerVista UR Setup software. Please refer to the EnerVista UR Setup Help File and Chapter 4 of this manual for more information.

a) CONFIGURING AN ETHERNET CONNECTION

Before starting, verify that the Ethernet network cable is properly connected to the Ethernet port on the back of the relay. To setup the relay for Ethernet communications, it will be necessary to define a Site, then add the relay as a Device at that site.

1. Install and start the latest version of the EnerVista UR Setup software (available from the GE enerVista CD or online from <http://www.GEindustrial.com/multilin> (see previous section for installation instructions).
2. Select the "UR" device from the enerVista Launchpad to start EnerVista UR Setup.
3. Click the **Device Setup** button to open the Device Setup window, then click the **Add Site** button to define a new site.
4. Enter the desired site name in the "Site Name" field. If desired, a short description of site can also be entered along with the display order of devices defined for the site. Click the **OK** button when complete.
5. The new site will appear in the upper-left list in the EnerVista UR Setup window. Click on the new site name and then click the **Device Setup** button to re-open the Device Setup window.
6. Click the **Add Device** button to define the new device.
7. Enter the desired name in the "Device Name" field and a description (optional) of the site.
8. Select "Ethernet" from the **Interface** drop-down list. This will display a number of interface parameters that must be entered for proper Ethernet functionality.
 - Enter the relay IP address (from **SETTINGS** ⇒ **PRODUCT SETUP** ⇒ **COMMUNICATIONS** ⇒ **NETWORK** ⇒ **IP ADDRESS**) in the "IP Address" field.
 - Enter the relay Modbus address (from the **PRODUCT SETUP** ⇒ **COMMUNICATIONS** ⇒ **MODBUS PROTOCOL** ⇒ **MODBUS SLAVE ADDRESS** setting) in the "Slave Address" field.
 - Enter the Modbus port address (from the **PRODUCT SETUP** ⇒ **COMMUNICATIONS** ⇒ **MODBUS PROTOCOL** ⇒ **MODBUS TCP PORT NUMBER** setting) in the "Modbus Port" field.
9. Click the **Read Order Code** button to connect to the T60 device and upload the order code. If an communications error occurs, ensure that the three EnerVista UR Setup values entered in the previous step correspond to the relay setting values.

10. Click **OK** when the relay order code has been received. The new device will be added to the Site List window (or Online window) located in the top left corner of the main EnerVista UR Setup window.

The Site Device has now been configured for Ethernet communications. Proceed to Section c) below to begin communications.

b) CONFIGURING AN RS232 CONNECTION

Before starting, verify that the RS232 serial cable is properly connected to the RS232 port on the front panel of the relay.

1. Install and start the latest version of the EnerVista UR Setup software (available from the GE enerVista CD or online from <http://www.GEindustrial.com/multilin>).
2. Select the **Device Setup** button to open the Device Setup window and click the **Add Site** button to define a new site.
3. Enter the desired site name in the "Site Name" field. If desired, a short description of site can also be entered along with the display order of devices defined for the site. Click the **OK** button when complete.
4. The new site will appear in the upper-left list in the EnerVista UR Setup window. Click on the new site name and then click the **Device Setup** button to re-open the Device Setup window.
5. Click the **Add Device** button to define the new device.
6. Enter the desired name in the "Device Name" field and a description (optional) of the site.
7. Select "Serial" from the **Interface** drop-down list. This will display a number of interface parameters that must be entered for proper serial communications.
 - Enter the relay slave address and COM port values (from the **SETTINGS** ⇒ **PRODUCT SETUP** ⇒ ⚡ **COMMUNICATIONS** ⇒ ⚡ **SERIAL PORTS** menu) in the "Slave Address" and "COM Port" fields.
 - Enter the physical communications parameters (baud rate and parity settings) in their respective fields.
8. Click the **Read Order Code** button to connect to the T60 device and upload the order code. If an communications error occurs, ensure that the EnerVista UR Setup serial communications values entered in the previous step correspond to the relay setting values.
9. Click "OK" when the relay order code has been received. The new device will be added to the Site List window (or Online window) located in the top left corner of the main EnerVista UR Setup window.

The Site Device has now been configured for RS232 communications. Proceed to Section c) Connecting to the Relay below to begin communications.

c) CONNECTING TO THE RELAY

1. Open the Display Properties window through the Site List tree as shown below:

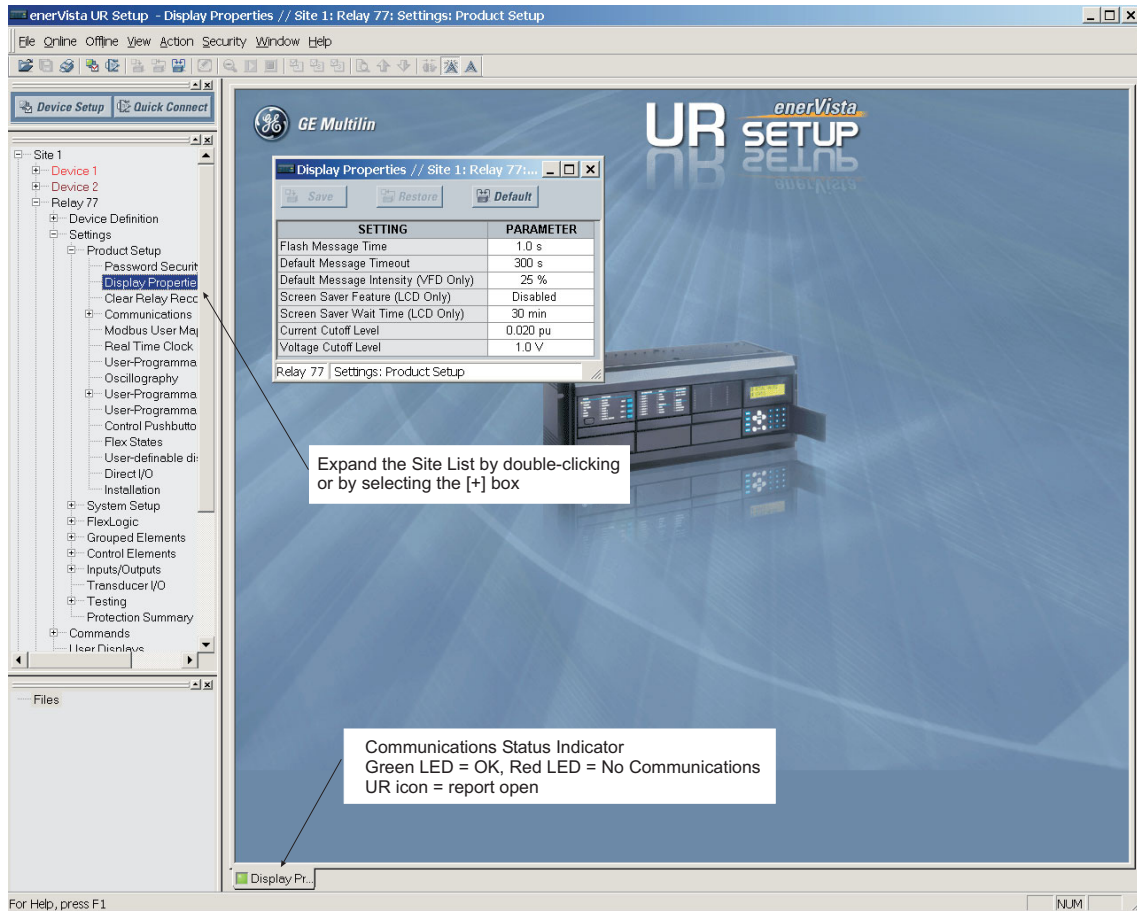

842743A1.CDR

- The Display Properties window will open with a status indicator on the lower left of the EnerVista UR Setup window.
- If the status indicator is red, verify that the Ethernet network cable is properly connected to the Ethernet port on the back of the relay and that the relay has been properly setup for communications (steps A and B earlier).
If a relay icon appears in place of the status indicator, then a report (such as an oscillography or event record) is open. Close the report to re-display the green status indicator.
- The Display Properties settings can now be edited, printed, or changed according to user specifications.



Refer to Chapter 4 in this manual and the EnerVista UR Setup Help File for more information about the using the EnerVista UR Setup software interface.

1.4.1 MOUNTING AND WIRING

Please refer to Chapter 3: Hardware for detailed mounting and wiring instructions. Review all **WARNINGS** and **CAUTIONS** carefully.

1.4.2 COMMUNICATIONS

The EnerVista UR Setup software communicates to the relay via the faceplate RS232 port or the rear panel RS485 / Ethernet ports. To communicate via the faceplate RS232 port, a standard “straight-through” serial cable is used. The DB-9 male end is connected to the relay and the DB-9 or DB-25 female end is connected to the PC COM1 or COM2 port as described in the CPU Communications Ports section of Chapter 3.

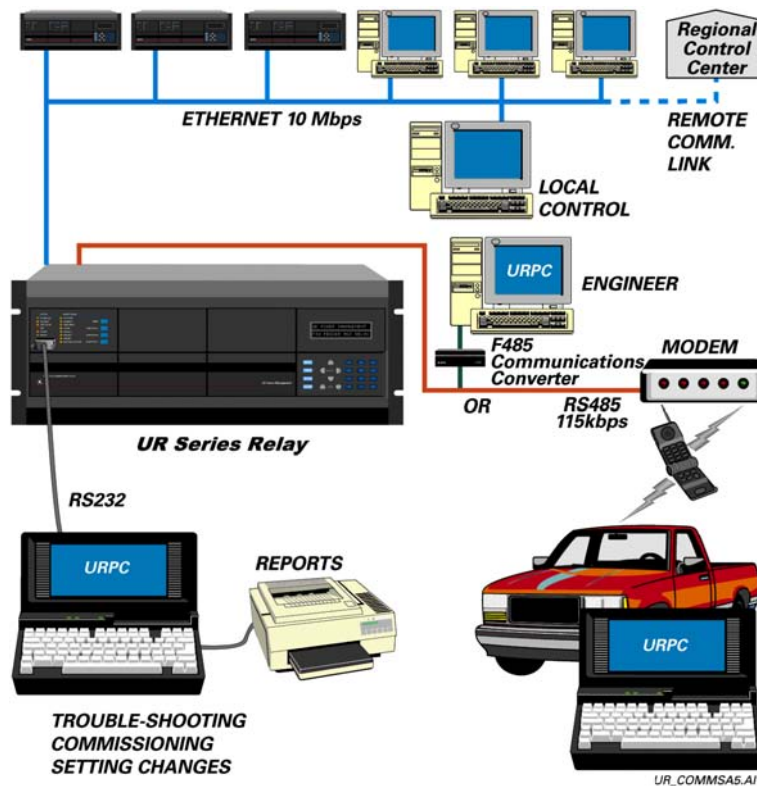

Figure 1–4: RELAY COMMUNICATIONS OPTIONS

To communicate through the T60 rear RS485 port from a PC RS232 port, the GE Multilin RS232/RS485 converter box is required. This device (catalog number F485) connects to the computer using a “straight-through” serial cable. A shielded twisted-pair (20, 22, or 24 AWG) connects the F485 converter to the T60 rear communications port. The converter terminals (+, –, GND) are connected to the T60 communication module (+, –, COM) terminals. Refer to the *CPU Communications Ports* section in Chapter 3 for option details. The line should be terminated with an R-C network (i.e. 120 Ω , 1 nF) as described in the Chapter 3.

1.4.3 FACEPLATE DISPLAY

All messages are displayed on a 2 × 20 character vacuum fluorescent display to make them visible under poor lighting conditions. An optional liquid crystal display (LCD) is also available. Messages are displayed in English and do not require the aid of an instruction manual for deciphering. While the keypad and display are not actively being used, the display will default to defined messages. Any high priority event driven message will automatically override the default message and appear on the display.

1.5.1 FACEPLATE KEYPAD

Display messages are organized into 'pages' under the following headings: Actual Values, Settings, Commands, and Targets. The **MENU** key navigates through these pages. Each heading page is broken down further into logical subgroups.

The **▲** **◀** MESSAGE **▶** **▼** keys navigate through the subgroups. The **▲** VALUE **▼** keys scroll increment or decrement numerical setting values when in programming mode. These keys also scroll through alphanumeric values in the text edit mode. Alternatively, values may also be entered with the numeric keypad.

The **■** key initiates and advance to the next character in text edit mode or enters a decimal point. The **HELP** key may be pressed at any time for context sensitive help messages. The **ENTER** key stores altered setting values.

1.5.2 MENU NAVIGATION

Press the **MENU** key to select the desired header display page (top-level menu). The header title appears momentarily followed by a header display page menu item. Each press of the **MENU** key advances through the main heading pages as illustrated below.

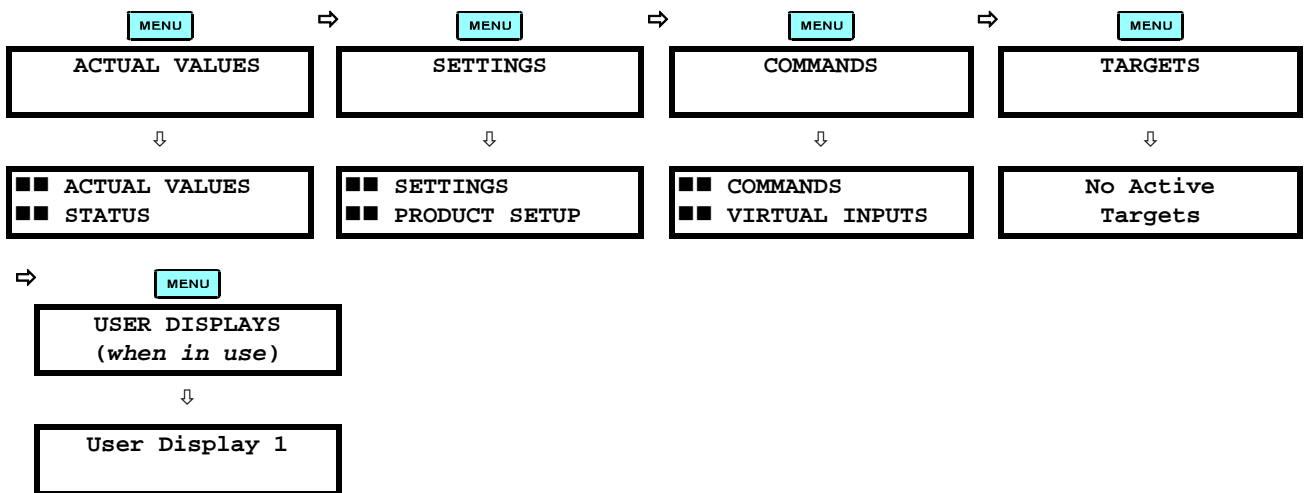

1.5.3 MENU HIERARCHY

The setting and actual value messages are arranged hierarchically. The header display pages are indicated by double scroll bar characters (■■), while sub-header pages are indicated by single scroll bar characters (■). The header display pages represent the highest level of the hierarchy and the sub-header display pages fall below this level. The MESSAGE **▲** and **▼** keys move within a group of headers, sub-headers, setting values, or actual values. Continually pressing the MESSAGE **▶** key from a header display displays specific information for the header category. Conversely, continually pressing the **◀** MESSAGE key from a setting value or actual value display returns to the header display.

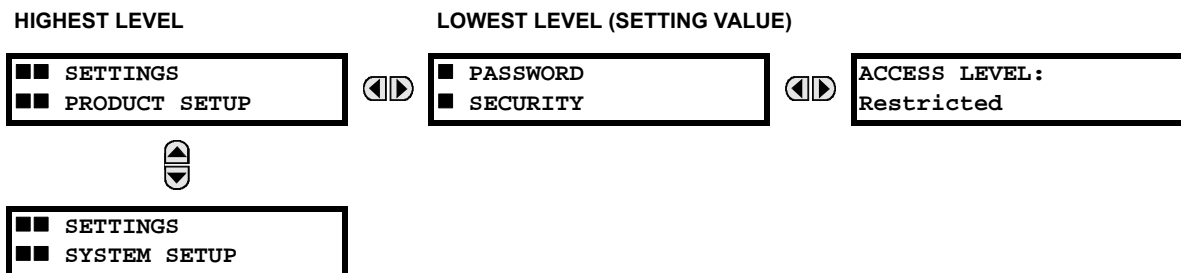



1.5.4 RELAY ACTIVATION

The relay is defaulted to the “Not Programmed” state when it leaves the factory. This safeguards against the installation of a relay whose settings have not been entered. When powered up successfully, the Trouble LED will be on and the In Service LED off. The relay in the “Not Programmed” state will block signaling of any output relay. These conditions will remain until the relay is explicitly put in the “Programmed” state.

Select the menu message **SETTINGS** ⇒ **PRODUCT SETUP** ⇒ **INSTALLATION** ⇒ **RELAY SETTINGS**

```
RELAY SETTINGS:
Not Programmed
```

To put the relay in the “Programmed” state, press either of the  VALUE  keys once and then press . The faceplate Trouble LED will turn off and the In Service LED will turn on. The settings for the relay can be programmed manually (refer to Chapter 5) via the faceplate keypad or remotely (refer to the EnerVista UR Setup Help file) via the EnerVista UR Setup software interface.

1.5.5 RELAY PASSWORDS

It is recommended that passwords be set up for each security level and assigned to specific personnel. There are two user password security access levels, COMMAND and SETTING:

1. COMMAND

The COMMAND access level restricts the user from making any settings changes, but allows the user to perform the following operations:

- change state of virtual inputs
- clear event records
- clear oscillography records
- operate user-programmable pushbuttons

2. SETTING

The SETTING access level allows the user to make any changes to any of the setting values.



Refer to the *Changing Settings* section in Chapter 4 for complete instructions on setting up security level passwords.

1.5.6 FLEXLOGIC™ CUSTOMIZATION

FlexLogic™ equation editing is required for setting up user-defined logic for customizing the relay operations. See the *Flex-Logic™* section in Chapter 5 for additional details.

Templated tables for charting all the required settings before entering them via the keypad are available from the GE Multilin website at <http://www.GEindustrial.com/multilin>. Commissioning tests are also included in the *Commissioning* chapter of this manual.

The T60 requires a minimum amount of maintenance when it is commissioned into service. The T60 is a microprocessor-based relay and its characteristics do not change over time. As such no further functional tests are required.

Furthermore the T60 performs a number of ongoing self-tests and takes the necessary action in case of any major errors (see the *Relay Self-Test* section in Chapter 7 for details). However, it is recommended that maintenance on the T60 be scheduled with other system maintenance. This maintenance may involve the following.

In-service maintenance:

1. Visual verification of the analog values integrity such as voltage and current (in comparison to other devices on the corresponding system).
2. Visual verification of active alarms, relay display messages, and LED indications.
3. LED test.
4. Visual inspection for any damage, corrosion, dust, or loose wires.
5. Event recorder file download with further events analysis.

Out-of-service maintenance:

1. Check wiring connections for firmness.
2. Analog values (currents, voltages, RTDs, analog inputs) injection test and metering accuracy verification. Calibrated test equipment is required.
3. Protection elements setpoints verification (analog values injection or visual verification of setting file entries against relay settings schedule).
4. Contact inputs and outputs verification. This test can be conducted by direct change of state forcing or as part of the system functional testing.
5. Visual inspection for any damage, corrosion, or dust.
6. Event recorder file download with further events analysis.
7. LED Test and pushbutton continuity check.

Unscheduled maintenance such as during a disturbance causing system interruption:

1. View the event recorder and oscillography or fault report for correct operation of inputs, outputs, and elements.

If it is concluded that the relay or one of its modules is of concern, contact GE Multilin or one of its representatives for prompt service.

2.1.1 OVERVIEW

The T60 Transformer Management Relay is a microprocessor-based relay for protection of small, medium, and large three-phase power transformers. The relay can be configured with a maximum of four three-phase current inputs and four ground current inputs, and can satisfy applications with transformer windings connected between two breakers, such as in a ring bus or in breaker-and-a-half configurations. The T60 performs magnitude and phase shift compensation internally, eliminating requirements for external CT connections and auxiliary CTs.

The Percent Differential element is the main protection device in the T60. Instantaneous Differential protection, Volts-per-Hertz, Restricted Ground Fault, and many current, voltage, and frequency-based protection elements are also incorporated. The T60 includes sixteen fully programmable universal comparators, or FlexElements™, that provide additional flexibility by allowing the user to customize their own protection functions that respond to any signals measured or calculated by the relay.

The metering functions of the T60 include true RMS and phasors for currents and voltages, current harmonics and THD, symmetrical components, frequency, power, power factor, and energy.

Diagnostic features include an event recorder capable of storing 1024 time-tagged events, oscillography capable of storing up to 64 records with programmable trigger, content and sampling rate, and data logger acquisition of up to 16 channels, with programmable content and sampling rate. Diagnostic features include a sequence of records capable of storing 1024 time-tagged events. The internal clock used for time-tagging can be synchronized with an IRIG-B signal or via the SNTP protocol over the Ethernet port. This precise time stamping allows the sequence of events to be determined throughout the system. Events can also be programmed (via FlexLogic™ equations) to trigger oscillography data capture which may be set to record the measured parameters before and after the event for viewing on a personal computer (PC). These tools significantly reduce troubleshooting time and simplify report generation in the event of a system fault.

A faceplate RS232 port may be used to connect to a PC for the programming of settings and the monitoring of actual values. A variety of communications modules are available. Two rear RS485 ports allow independent access by operating and engineering staff. All serial ports use the Modbus® RTU protocol. The RS485 ports may be connected to system computers with baud rates up to 115.2 kbps. The RS232 port has a fixed baud rate of 19.2 kbps. Optional communications modules include a 10BaseF Ethernet interface which can be used to provide fast, reliable communications in noisy environments. Another option provides two 10BaseF fiber optic ports for redundancy. The Ethernet port supports IEC 61850, Modbus®/TCP, and TFTP protocols, and allows access to the relay via any standard web browser (T60 web pages). The IEC 60870-5-104 protocol is supported on the Ethernet port. DNP 3.0 and IEC 60870-5-104 cannot be enabled at the same time.

The T60 IEDs use flash memory technology which allows field upgrading as new features are added. The following Single Line Diagram illustrates the relay functionality using ANSI (American National Standards Institute) device numbers.

Table 2–1: DEVICE NUMBERS AND FUNCTIONS

DEVICE NUMBER	FUNCTION	DEVICE NUMBER	FUNCTION
24	Volts Per Hertz	59N	Neutral Overvoltage
27	Phase Undervoltage	59P	Phase Overvoltage
27X	Auxiliary Undervoltage	59X	Auxiliary Overvoltage
50/87	Instantaneous Differential Overcurrent	67N	Neutral Directional Overcurrent
50G	Ground Instantaneous Overcurrent	67P	Phase Directional Overcurrent
50N	Neutral Instantaneous Overcurrent	81O	Overfrequency
50P	Phase Instantaneous Overcurrent	81U	Underfrequency
51G	Ground Time Overcurrent	87G	Restricted Ground Fault
51N	Neutral Time Overcurrent	87T	Transformer Differential
51P	Phase Time Overcurrent		

2

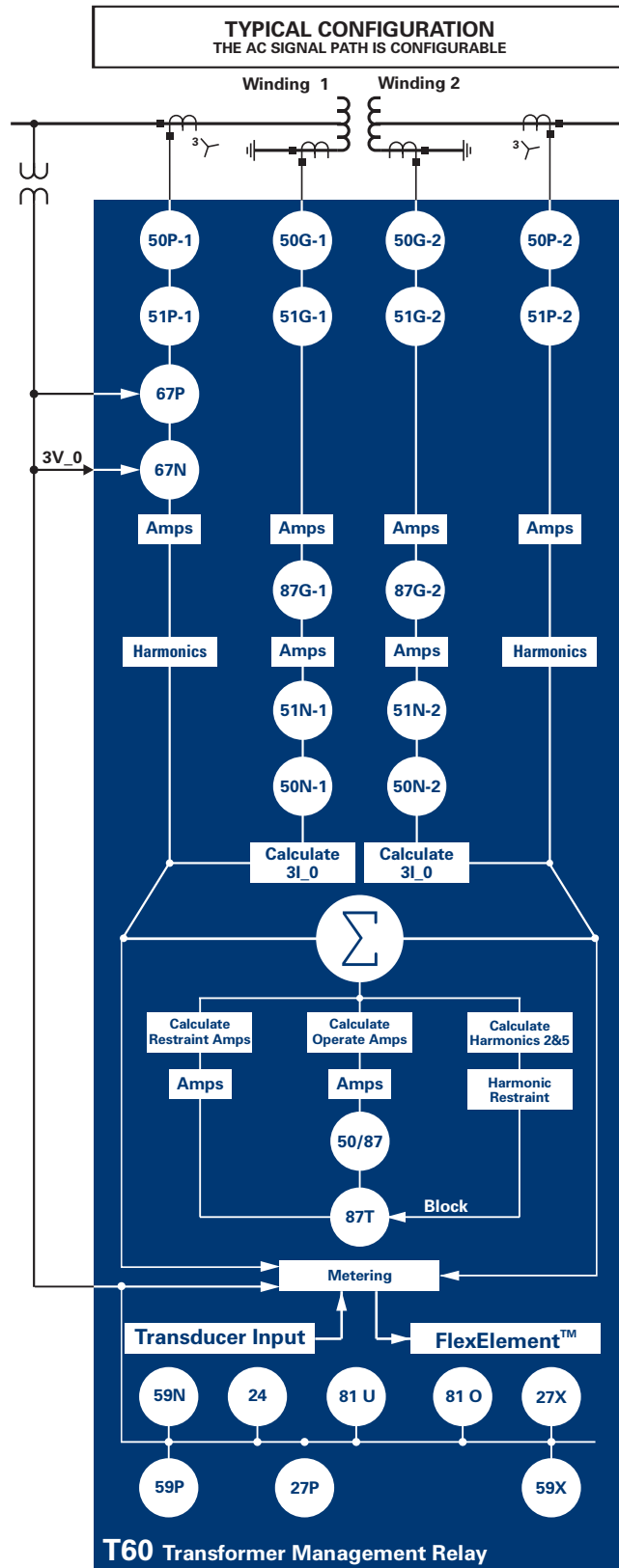

Figure 2–1: SINGLE LINE DIAGRAM

Table 2–2: OTHER DEVICE FUNCTIONS

FUNCTION	FUNCTION	FUNCTION
Breaker Arcing Current I ² t	FlexLogic™ Equations	Transducer Inputs/Outputs
Contact Inputs (up to 96)	IEC 61850 Communications	Transformer Aging Factor
Contact Outputs (up to 64)	Metering: Current, Voltage, Power, Power Factor, Energy, Frequency, Harmonics, THD	Transformer Hottest-Spot Temperature
Control Pushbuttons	Modbus Communications	Transformer Loss-of-Life
Data Logger	Modbus User Map	User Definable Displays
Digital Counters (8)	Non-Volatile Latches	User Programmable Fault Reports
Digital Elements (48)	Non-Volatile Selector Switch	User Programmable LEDs
Direct Inputs/Outputs (32)	Oscillography	User Programmable Pushbuttons
DNP 3.0 or IEC 60870-5-104 Protocol	Setting Groups (6)	User Programmable Self-Tests
Ethernet Global Data (EGD) Protocol	Time Synchronization over SNTP	Virtual Inputs (64)
Event Recorder		Virtual Outputs (96)
FlexElements™ (16)		

2.1.2 ORDERING

The relay is available as a 19-inch rack horizontal mount unit or a reduced size ($\frac{3}{4}$) vertical mount unit, and consists of the following modules: power supply, CPU, CT/VT, digital input/output, transducer input/output. Each of these modules can be supplied in a number of configurations specified at the time of ordering. The information required to completely specify the relay is provided in the following table (see Chapter 3 for full details of relay modules).

Table 2-3: T60 ORDER CODES

	T60 - * 00 - H * * - F ** - H ** - M ** - P ** - U ** - W/X **	T60 - * 00 - V F * - F ** - H ** - M ** - P ** - U ** - # **								
BASE UNIT	T60									Full Size Horizontal Mount
CPU	E G H J K L M N P R									Reduced Size Vertical Mount (see note below for value of slot #) Base Unit RS485 and RS485 RS485 and multi-mode ST 10Base-F RS485 and multi-mode ST redundant 10Base-F RS485 and multi-mode ST 100Base-FX RS485 and multi-mode ST redundant 100Base-FX RS485 and single mode SC 100Base-FX RS485 and single mode SC redundant 100Base-FX RS485 and 10/100Base-T RS485 and single mode ST 100Base-FX RS485 and single mode ST redundant 100Base-FX
SOFTWARE	00 01 03 04									No Software Options Ethernet Global Data (EGD); not available for Type 9E CPUs IEC 61850, not available for Type 9E CPUs Ethernet Global Data (EGD) and IEC 61850; not available for Type 9E CPUs
MOUNT/COATING		H A V B								Horizontal (19" rack) Horizontal (19" rack) with harsh environmental coating Vertical (3/4 rack) Vertical (3/4 rack) with harsh environmental coating
FACEPLATE/ DISPLAY (applicable only to horizontal mount units)		C P A B D G R S								English display English display with 4 small and 12 large programmable pushbuttons Chinese display Chinese display with 4 small and 12 large programmable pushbuttons French display French display with 4 small and 12 large programmable pushbuttons Russian display Russian display with 4 small and 12 large programmable pushbuttons
POWER SUPPLY (redundant supply only available in horizontal units; must be same type as main supply)		H H L L								RH 125 / 250 V AC/DC with redundant 125 / 250 V AC/DC power supply 24 to 48 V (DC only) power supply RL 24 to 48 V (DC only) with redundant 24 to 48 V DC power supply
CT/VT MODULES			8F 8G 8H 8J		8F 8G 8H 8J					Standard 4CT/4VT Sensitive Ground 4CT/4VT Standard 8CT Sensitive Ground 8CT
DIGITAL INPUTS/OUTPUTS				XX 4A 4B 4C 4D 4L 67 6A 6B 6C 6D 6E 6F 6G 6H 6K 6L 6M 6N 6P 6R 6S 6T 6U	XX 4A 4B 4C 4D 4L 67 6A 6B 6C 6D 6E 6F 6G 6H 6K 6L 6M 6N 6P 6R 6S 6T 6U	XX 4A 4B 4C 4D 4L 67 6A 6B 6C 6D 6E 6F 6G 6H 6K 6L 6M 6N 6P 6R 6S 6T 6U	XX 4A 4B 4C 4D 4L 67 6A 6B 6C 6D 6E 6F 6G 6H 6K 6L 6M 6N 6P 6R 6S 6T 6U	XX 4A 4B 4C 4D 4L 67 6A 6B 6C 6D 6E 6F 6G 6H 6K 6L 6M 6N 6P 6R 6S 6T 6U	No Module 4 Solid-State (no monitoring) MOSFET outputs 4 Solid-State (voltage with optional current) MOSFET outputs 4 Solid-State (current with optional voltage) MOSFET outputs 16 digital inputs with Auto-Burnishing 14 Form-A (no monitoring) Latching outputs 8 Form-A (no monitoring) outputs 2 Form-A (voltage with optional current) and 2 Form-C outputs, 8 digital inputs 2 Form-A (voltage with optional current) and 4 Form-C outputs, 4 digital inputs 8 Form-C outputs 16 digital inputs 4 Form-C outputs, 8 digital inputs 8 Fast Form-C outputs 4 Form-A (voltage with optional current) outputs, 8 digital inputs 6 Form-A (voltage with optional current) outputs, 4 digital inputs 4 Form-C and 4 Fast Form-C outputs 2 Form-A (current with optional voltage) and 2 Form-C outputs, 8 digital inputs 4 Form-A (current with optional voltage) outputs, 8 digital inputs 6 Form-A (current with optional voltage) outputs, 4 digital inputs 2 Form-A (no monitoring) and 2 Form-C outputs, 8 digital inputs 2 Form-A (no monitoring) and 4 Form-C outputs, 4 digital inputs 4 Form-A (no monitoring) outputs, 8 digital inputs 6 Form-A (no monitoring) outputs, 4 digital inputs	
TRANSDUCER INPUTS/OUTPUTS (select a maximum of 3 per unit)			5A 5C 5D 5E 5F		5A 5C 5D 5E 5F					4 dcmA inputs, 4 dcmA outputs (only one 5A module is allowed) 8 RTD inputs 4 RTD inputs, 4 dcmA outputs (only one 5D module is allowed) 4 RTD inputs, 4 dcmA inputs 8 dcmA inputs
INTER-RELAY COMMUNICATIONS (select a maximum of 1 per unit)										2A C37.94SM, 1300nm single-mode, ELED, 1 channel single-mode 2B C37.94SM, 1300nm single-mode, ELED, 2 channel single-mode 2E Bi-phase, single channel 2F Bi-phase, dual channel 72 1550 nm, single-mode, LASER, 1 Channel 73 1550 nm, single-mode, LASER, 2 Channel 74 Channel 1 - RS422; Channel 2 - 1550 nm, single-mode, LASER 75 Channel 1 - G.703; Channel 2 - 1550 nm, Single-mode LASER 76 IEEE C37.94, 820 nm, multimode, LED, 1 Channel 77 IEEE C37.94, 820 nm, multimode, LED, 2 Channels 7A 820 nm, multi-mode, LED, 1 Channel 7B 1300 nm, multi-mode, LED, 1 Channel 7C 1300 nm, single-mode, ELED, 1 Channel 7D 1300 nm, single-mode, LASER, 1 Channel 7E Channel 1 - G.703; Channel 2 - 820 nm, multi-mode 7F Channel 1 - G.703; Channel 2 - 1300 nm, multi-mode 7G Channel 1 - G.703; Channel 2 - 1300 nm, single-mode ELED 7H 820 nm, multi-mode, LED, 2 Channels 7I 1300 nm, multi-mode, LED, 2 Channels 7J 1300 nm, single-mode, ELED, 2 Channels 7K 1300 nm, single-mode, LASER, 2 Channels 7L Channel 1 - RS422; Channel 2 - 820 nm, multi-mode, LED 7M Channel 1 - RS422; Channel 2 - 1300 nm, multi-mode, LED 7N Channel 1 - RS422; Channel 2 - 1300 nm, single-mode, ELED 7P Channel 1 - RS422; Channel 2 - 1300 nm, single-mode, LASER 7Q Channel 1 - G.703; Channel 2 - 1300 nm, single-mode LASER 7R G.703, 1 Channel 7S G.703, 2 Channels 7T RS422, 1 Channel 7W RS422, 2 Channels

NOTE For vertical mounting units, # = slot P for digital and transducer input/output modules; # = slot R for inter-relay communications modules

The order codes for replacement modules to be ordered separately are shown in the following table. When ordering a replacement CPU module or faceplate, please provide the serial number of your existing unit.

Table 2–4: ORDER CODES FOR REPLACEMENT MODULES

	UR - ** -	
POWER SUPPLY (redundant supply only available in horizontal units; must be same type as main supply)	1H	125 / 250 V AC/DC
	1L	24 to 48 V (DC only)
	RH	redundant 125 / 250 V AC/DC
	RH	redundant 24 to 48 V (DC only)
CPU	9E	RS485 and RS485 (ModBus RTU, DNP 3.0)
	9G	RS485 and 10Base-F (Ethernet, Modbus TCP/IP, DNP 3.0)
	9H	RS485 and Redundant 10Base-F (Ethernet, ModBus TCP/IP, DNP 3.0)
	9J	RS485 and multi-mode ST 100Base-FX
	9K	RS485 and multi-mode ST redundant 100Base-FX
	9L	RS485 and single mode SC 100Base-FX
	9M	RS485 and single mode SC redundant 100Base-FX
	9N	RS485 and 10/100Base-T
	9P	RS485 and single mode ST 100Base-FX
	9R	RS485 and single mode ST redundant 100Base-FX
FACEPLATE/DISPLAY	3C	Horizontal faceplate with keypad and English display
	3P	Horizontal faceplate with keypad, user-programmable pushbuttons, and English display
	3R	Horizontal faceplate with keypad and Russian display
	3S	Horizontal faceplate with keypad, user-programmable pushbuttons, and Russian display
	3A	Horizontal faceplate with keypad and Chinese display
	3B	Horizontal faceplate with keypad, user-programmable pushbuttons, and Chinese display
	3D	Horizontal faceplate with keypad and French display
	3G	Horizontal faceplate with keypad, user-programmable pushbuttons, and French display
DIGITAL INPUTS/OUTPUTS	3F	Vertical faceplate with keypad and English display
	4A	4 Solid-State (no monitoring) MOSFET outputs
	4B	4 Solid-State (voltage with optional current) MOSFET outputs
	4C	4 Solid-State (current with optional voltage) MOSFET outputs
	4D	16 digital inputs with Auto-Burnishing
	4L	14 Form-A (no monitoring) Latching outputs
	67	8 Form-A (no monitoring) outputs
	6A	2 Form-A (voltage with optional current) and 2 Form-C outputs, 8 digital inputs
	6B	2 Form-A (voltage with optional current) and 4 Form-C outputs, 4 digital inputs
	6C	8 Form-C outputs
	6D	16 digital inputs
	6E	4 Form-C outputs, 8 digital inputs
	6F	8 Fast Form-C outputs
	6G	4 Form-A (voltage with optional current) outputs, 8 digital inputs
	6H	6 Form-A (voltage with optional current) outputs, 4 digital inputs
	6K	4 Form-C and 4 Fast Form-C outputs
	6L	2 Form-A (current with optional voltage) and 2 Form-C outputs, 8 digital inputs
	6M	2 Form-A (current with optional voltage) and 4 Form-C outputs, 4 digital inputs
	6N	4 Form-A (current with optional voltage) outputs, 8 digital inputs
	6P	6 Form-A (current with optional voltage) outputs, 4 digital inputs
6R	2 Form-A (no monitoring) and 2 Form-C outputs, 8 digital inputs	
6S	2 Form-A (no monitoring) and 4 Form-C outputs, 4 digital inputs	
6T	4 Form-A (no monitoring) outputs, 8 digital inputs	
6U	6 Form-A (no monitoring) outputs, 4 digital inputs	
CT/VT MODULES (NOT AVAILABLE FOR THE C30)	8F	Standard 4CT/4VT
	8G	Sensitive Ground 4CT/4VT
	8H	Standard 8CT
	8J	Sensitive Ground 8CT
UR INTER-RELAY COMMUNICATIONS	2A	C37.94SM, 1300nm single-mode, ELED, 1 channel single-mode
	2B	C37.94SM, 1300nm single-mode, ELED, 2 channel single-mode
	72	1550 nm, single-mode, LASER, 1 Channel
	73	1550 nm, single-mode, LASER, 2 Channel
	74	Channel 1 - RS422; Channel 2 - 1550 nm, single-mode, LASER
	75	Channel 1 - G.703; Channel 2 - 1550 nm, Single-mode LASER
	76	IEEE C37.94, 820 nm, multimode, LED, 1 Channel
	77	IEEE C37.94, 820 nm, multimode, LED, 2 Channels
	7A	820 nm, multi-mode, LED, 1 Channel
	7B	1300 nm, multi-mode, LED, 1 Channel
	7C	1300 nm, single-mode, ELED, 1 Channel
	7D	1300 nm, single-mode, LASER, 1 Channel
	7E	Channel 1 - G.703; Channel 2 - 820 nm, multi-mode
	7F	Channel 1 - G.703; Channel 2 - 1300 nm, multi-mode
	7G	Channel 1 - G.703; Channel 2 - 1300 nm, single-mode ELED
	7H	820 nm, multi-mode, LED, 2 Channels
	7I	1300 nm, multi-mode, LED, 2 Channels
	7J	1300 nm, single-mode, ELED, 2 Channels
	7K	1300 nm, single-mode, LASER, 2 Channels
	7L	Channel 1 - RS422; Channel 2 - 820 nm, multi-mode, LED
7M	Channel 1 - RS422; Channel 2 - 1300 nm, multi-mode, LED	
7N	Channel 1 - RS422; Channel 2 - 1300 nm, single-mode, ELED	
7P	Channel 1 - RS422; Channel 2 - 1300 nm, single-mode, LASER	
7Q	Channel 1 - G.703; Channel 2 - 1300 nm, single-mode LASER	
7R	G.703, 1 Channel	
7S	G.703, 2 Channels	
7T	RS422, 1 Channel	
7W	RS422, 2 Channels	
TRANSDUCER INPUTS/OUTPUTS	5A	4 dcmA inputs, 4 dcmA outputs (only one 5A module is allowed)
	5C	8 RTD inputs
	5D	4 RTD inputs, 4 dcmA outputs (only one 5D module is allowed)
	5E	4 dcmA inputs, 4 RTD inputs
	5F	8 dcmA inputs

SPECIFICATIONS ARE SUBJECT TO CHANGE WITHOUT NOTICE

2.2.1 PROTECTION ELEMENTS



The operating times below include the activation time of a trip rated Form-A output contact unless otherwise indicated. FlexLogic™ operands of a given element are 4 ms faster. This should be taken into account when using FlexLogic™ to interconnect with other protection or control elements of the relay, building FlexLogic™ equations, or interfacing with other IEDs or power system devices via communications or different output contacts.

PERCENT DIFFERENTIAL

Characteristic:	Differential Restraint pre-set
Number of zones:	2
Minimum pickup:	0.05 to 1.00 pu in steps of 0.001
Slope 1 range:	15 to 100% in steps of 1%
Slope 2 range:	50 to 100% in steps of 1%
Kneepoint 1:	1.0 to 2.0 pu in steps of 0.0001
Kneepoint 2:	2.0 to 30.0 pu in steps of 0.0001
2 nd harmonic inhibit level:	1.0 to 40.0% in steps of 0.1
2 nd harmonic inhibit function:	Adaptive, Traditional, Disabled
2 nd harmonic inhibit mode:	Per-phase, 2-out-of-3, Average
5 th harmonic inhibit range:	1.0 to 40.0% in steps of 0.1
Operate times:	
Harmonic inhibits selected:	20 to 30 ms at 60 Hz; 20 to 35 ms at 50 Hz
No harmonic inhibits selected:	5 to 20 ms
Dropout level:	97 to 98% of pickup
Level accuracy:	±0.5% of reading or ±1% of rated (whichever is greater)

INSTANTANEOUS DIFFERENTIAL

Pickup level:	2.00 to 30.00 pu in steps of 0.01
Dropout level:	97 to 98% of pickup
Level accuracy:	±0.5% of reading or ±1% of rated (whichever is greater)
Operate time:	< 20 ms at 3 × pickup at 60 Hz

RESTRICTED GROUND FAULT

Pickup:	0.000 to 30.000 pu in steps of 0.001
Dropout:	97 to 98% of Pickup
Slope:	0 to 100% in steps of 1%
Pickup delay:	0 to 600.00 s in steps of 0.01
Dropout delay:	0 to 600.00 s in steps of 0.01
Operate time:	<1 power system cycle

PHASE/NEUTRAL/GROUND TOC

Current:	Phasor or RMS
Pickup level:	0.000 to 30.000 pu in steps of 0.001
Dropout level:	97% to 98% of Pickup
Level accuracy:	
for 0.1 to 2.0 × CT:	±0.5% of reading or ±1% of rated (whichever is greater)
for > 2.0 × CT:	±1.5% of reading > 2.0 × CT rating
Curve shapes:	IEEE Moderately/Very/Extremely Inverse; IEC (and BS) A/B/C and Short Inverse; GE IAC Inverse, Short/Very/ Extremely Inverse; I ² t; FlexCurves™ (programmable); Definite Time (0.01 s base curve)
Curve multiplier:	Time Dial = 0.00 to 600.00 in steps of 0.01
Reset type:	Instantaneous/Timed (per IEEE)
Timing accuracy:	Operate at > 1.03 × actual Pickup ±3.5% of operate time or ±½ cycle (whichever is greater)

PHASE/NEUTRAL/GROUND IOG

Pickup level:	0.000 to 30.000 pu in steps of 0.001
Dropout level:	97 to 98% of pickup
Level accuracy:	
0.1 to 2.0 × CT rating:	±0.5% of reading or ±1% of rated (whichever is greater)
> 2.0 × CT rating	±1.5% of reading
Overreach:	<2%
Pickup delay:	0.00 to 600.00 s in steps of 0.01
Reset delay:	0.00 to 600.00 s in steps of 0.01
Operate time:	<16 ms at 3 × Pickup at 60 Hz (Phase/Ground IOG) <20 ms at 3 × Pickup at 60 Hz (Neutral IOG)
Timing accuracy:	Operate at 1.5 × Pickup ±3% or ±4 ms (whichever is greater)

PHASE DIRECTIONAL OVERCURRENT

Relay connection:	90° (quadrature)
Quadrature voltage:	
ABC phase seq.: phase A (V _{BC}), phase B (V _{CA}), phase C (V _{AB})	
ACB phase seq.: phase A (V _{CB}), phase B (V _{AC}), phase C (V _{BA})	
Polarizing voltage threshold:	0.000 to 3.000 pu in steps of 0.001
Current sensitivity threshold:	0.05 pu
Characteristic angle:	0 to 359° in steps of 1
Angle accuracy:	±2°
Operation time (FlexLogic™ operands):	
Tripping (reverse load, forward fault):	< 12 ms, typically
Blocking (forward load, reverse fault):	< 8 ms, typically

NEUTRAL DIRECTIONAL OVERCURRENT

Directionality:	Co-existing forward and reverse
Polarizing:	Voltage, Current, Dual
Polarizing voltage:	V ₀ or VX
Polarizing current:	IG
Operating current:	I ₀
Level sensing:	$3 \times (I_0 - K \times I_1)$, IG Independent for forward and reverse
Restraint, K:	0.000 to 0.500 in steps of 0.001
Characteristic angle:	-90 to 90° in steps of 1
Limit angle:	40 to 90° in steps of 1, independent for forward and reverse
Angle accuracy:	±2°
Offset impedance:	0.00 to 250.00 Ω in steps of 0.01
Pickup level:	0.002 to 30.000 pu in steps of 0.01
Dropout level:	97 to 98%
Operation time:	< 16 ms at 3 × Pickup at 60 Hz

PHASE UNDERVOLTAGE

Pickup level:	0.000 to 3.000 pu in steps of 0.001
Dropout level:	102 to 103% of pickup
Level accuracy:	±0.5% of reading from 10 to 208 V
Curve shapes:	GE IAV Inverse; Definite Time (0.1s base curve)
Curve multiplier:	Time dial = 0.00 to 600.00 in steps of 0.01
Timing accuracy:	Operate at < 0.90 × pickup ±3.5% of operate time or ±4 ms (whichever is greater)

AUXILIARY UNDERVOLTAGE

Pickup level:	0.000 to 3.000 pu in steps of 0.001
Dropout level:	102 to 103% of pickup
Level accuracy:	±0.5% of reading from 10 to 208 V
Curve shapes:	GE IAV Inverse, Definite Time
Curve multiplier:	Time Dial = 0 to 600.00 in steps of 0.01
Timing accuracy:	±3% of operate time or ±4 ms (whichever is greater)

PHASE OVERVOLTAGE

Voltage:	Phasor only
Pickup level:	0.000 to 3.000 pu in steps of 0.001
Dropout level:	97 to 98% of Pickup
Level accuracy:	±0.5% of reading from 10 to 208 V
Pickup delay:	0.00 to 600.00 in steps of 0.01 s
Operate time:	< 30 ms at 1.10 × Pickup at 60 Hz
Timing accuracy:	±3% or ±4 ms (whichever is greater)

NEUTRAL OVERVOLTAGE

Pickup level:	0.000 to 1.250 pu in steps of 0.001
Dropout level:	97 to 98% of Pickup
Level accuracy:	±0.5% of reading from 10 to 208 V
Pickup delay:	0.00 to 600.00 s in steps of 0.01
Reset delay:	0.00 to 600.00 s in steps of 0.01
Timing accuracy:	±3% or ±4 ms (whichever is greater)
Operate time:	< 30 ms at 1.10 × Pickup at 60 Hz

AUXILIARY OVERVOLTAGE

Pickup level:	0.000 to 3.000 pu in steps of 0.001
Dropout level:	97 to 98% of Pickup
Level accuracy:	±0.5% of reading from 10 to 208 V
Pickup delay:	0 to 600.00 s in steps of 0.01
Reset delay:	0 to 600.00 s in steps of 0.01
Timing accuracy:	±3% of operate time or ±4 ms (whichever is greater)
Operate time:	< 30 ms at 1.10 × pickup at 60 Hz

VOLTS PER HERTZ

Voltage:	Phasor only
Pickup level:	0.80 to 4.00 in steps of 0.01 pu V/Hz
Dropout level:	97 to 98% of Pickup
Level accuracy:	±0.02 pu
Timing curves:	Definite Time; Inverse A, B, and C, FlexCurves™ A, B, C, and D
TD Multiplier:	0.05 to 600.00 s in steps of 0.01
Reset delay:	0.0 to 1000.0 s in steps of 0.1
Timing accuracy:	±3% or ±15 cycles (whichever is greater)

TRANSFORMER HOTTEST-SPOT TEMPERATURE

Operating quantity:	computed temperature in °C
Pickup level:	50 to 300°C in steps of 1
Dropout level:	1°C below pickup
Pickup delay:	0 to 30000 min. in steps of 1

TRANSFORMER AGING FACTOR

Operating quantity:	computed aging acceleration factor (pu)
Pickup level:	1 to 10 pu in steps of 0.1
Pickup delay:	0 to 30000 min. in steps of 1

TRANSFORMER LOSS OF LIFE

Operating quantity:	computed accumulated transformer loss of life, in hours
Pickup level:	0 to 500000 hours in steps of 1

UNDERFREQUENCY

Minimum signal:	0.10 to 1.25 pu in steps of 0.01
Pickup level:	20.00 to 65.00 Hz in steps of 0.01
Dropout level:	Pickup + 0.03 Hz
Level accuracy:	±0.01 Hz
Time delay:	0 to 65.535 s in steps of 0.001
Timer accuracy:	±3% or 4 ms, whichever is greater

OVERFREQUENCY

Pickup level:	20.00 to 65.00 Hz in steps of 0.01
Dropout level:	Pickup - 0.03 Hz
Level accuracy:	±0.01 Hz
Time delay:	0 to 65.535 s in steps of 0.001
Timer accuracy:	±3% or 4 ms, whichever is greater

BREAKER ARCING CURRENT

Principle:	accumulates breaker duty (I^2t) and measures fault duration
Initiation:	programmable per phase from any Flex-Logic™ operand
Compensation for auxiliary relays:	0 to 65.535 s in steps of 0.001
Alarm threshold:	0 to 50000 kA ² -cycle in steps of 1
Fault duration accuracy:	0.25 of a power cycle
Availability:	1 per CT bank with a minimum of 2

2.2.2 USER-PROGRAMMABLE ELEMENTS

FLEXLOGIC™

Programming language:	Reverse Polish Notation with graphical visualization (keypad programmable)
Lines of code:	512
Internal variables:	64
Supported operations:	NOT, XOR, OR (2 to 16 inputs), AND (2 to 16 inputs), NOR (2 to 16 inputs), NAND (2 to 16 inputs), Latch (Reset dominant), Edge Detectors, Timers
Inputs:	any logical variable, contact, or virtual input
Number of timers:	32
Pickup delay:	0 to 60000 (ms, sec., min.) in steps of 1
Dropout delay:	0 to 60000 (ms, sec., min.) in steps of 1

FLEXCURVES™

Number:	4 (A through D)
Reset points:	40 (0 through 1 of pickup)
Operate points:	80 (1 through 20 of pickup)
Time delay:	0 to 65535 ms in steps of 1

FLEX STATES

Number:	up to 256 logical variables grouped under 16 Modbus addresses
Programmability:	any logical variable, contact, or virtual input

FLEXELEMENTS™

Number of elements:	16
Operating signal:	any analog actual value, or two values in differential mode
Operating signal mode:	Signed or Absolute Value
Operating mode:	Level, Delta
Comparator direction:	Over, Under
Pickup Level:	-30.000 to 30.000 pu in steps of 0.001
Hysteresis:	0.1 to 50.0% in steps of 0.1
Delta dt:	20 ms to 60 days
Pickup & dropout delay:	0.000 to 65.535 s in steps of 0.001

NON-VOLATILE LATCHES

Type:	Set-dominant or Reset-dominant
Number:	16 (individually programmed)
Output:	Stored in non-volatile memory
Execution sequence:	As input prior to protection, control, and FlexLogic™

USER-PROGRAMMABLE LEDs

Number:	48 plus Trip and Alarm
Programmability:	from any logical variable, contact, or virtual input
Reset mode:	Self-reset or Latched

LED TEST

Initiation:	from any digital input or user-programmable condition
Number of tests:	3, interruptible at any time
Duration of full test:	approximately 3 minutes
Test sequence 1:	all LEDs on
Test sequence 2:	all LEDs off, one LED at a time on for 1 s
Test sequence 3:	all LEDs on, one LED at a time off for 1 s

USER-DEFINABLE DISPLAYS

Number of displays:	16
Lines of display:	2 × 20 alphanumeric characters
Parameters:	up to 5, any Modbus register addresses
Invoking and scrolling:	keypad, or any user-programmable condition, including pushbuttons

CONTROL PUSHBUTTONS

Number of pushbuttons:	7
Operation:	drive FlexLogic™ operands

USER-PROGRAMMABLE PUSHBUTTONS (OPTIONAL)

Number of pushbuttons:	12
Mode:	Self-Reset, Latched
Display message:	2 lines of 20 characters each

SELECTOR SWITCH

Number of elements:	2
Upper position limit:	1 to 7 in steps of 1
Selecting mode:	Time-out or Acknowledge
Time-out timer:	3.0 to 60.0 s in steps of 0.1
Control inputs:	step-up and 3-bit
Power-up mode:	restore from non-volatile memory or synchronize to a 3-bit control input or Synch/Restore mode

2.2.3 MONITORING

OSCILLOGRAPHY

Maximum records:	64
Sampling rate:	64 samples per power cycle
Triggers:	Any element pickup, dropout or operate Digital input change of state Digital output change of state FlexLogic™ equation
Data:	AC input channels Element state Digital input state Digital output state
Data storage:	In non-volatile memory

EVENT RECORDER

Capacity:	1024 events
Time-tag:	to 1 microsecond
Triggers:	Any element pickup, dropout or operate Digital input change of state Digital output change of state Self-test events
Data storage:	In non-volatile memory

USER-PROGRAMMABLE FAULT REPORT

Number of elements:	2
Pre-fault trigger:	any FlexLogic™ operand
Fault trigger:	any FlexLogic™ operand
Recorder quantities:	32 (any FlexAnalog value)

DATA LOGGER

Number of channels:	1 to 16
Parameters:	Any available analog actual value
Sampling rate:	15 to 3600000 ms in steps of 1
Trigger:	any FlexLogic™ operand
Mode:	continuous or triggered
Storage capacity:	(NN is dependent on memory)
1-second rate:	01 channel for NN days 16 channels for NN days
↓	↓
60-minute rate:	01 channel for NN days 16 channels for NN days

2.2.4 METERING

RMS CURRENT: PHASE, NEUTRAL, AND GROUND

Accuracy at	
0.1 to 2.0 × CT rating:	±0.25% of reading or ±0.1% of rated (whichever is greater)
> 2.0 × CT rating:	±1.0% of reading

RMS VOLTAGE

Accuracy:	±0.5% of reading from 10 to 208 V
-----------	-----------------------------------

REAL POWER (WATTS)

Accuracy:	±1.0% of reading at −0.8 < PF ≤ −1.0 and 0.8 < PF ≤ 1.0
-----------	--

REACTIVE POWER (VARs)

Accuracy:	±1.0% of reading at −0.2 ≤ PF ≤ 0.2
-----------	-------------------------------------

APPARENT POWER (VA)

Accuracy:	±1.0% of reading
-----------	------------------

WATT-HOURS (POSITIVE AND NEGATIVE)

Accuracy:	±2.0% of reading
Range:	±0 to 2 × 10 ⁹ MWh
Parameters:	3-phase only
Update rate:	50 ms

VAR-HOURS (POSITIVE AND NEGATIVE)

Accuracy:	±2.0% of reading
Range:	±0 to 2 × 10 ⁹ Mvarh
Parameters:	3-phase only
Update rate:	50 ms

CURRENT HARMONICS

Harmonics:	2nd to 25th harmonic: per phase, displayed as a % of f ₁ (fundamental frequency phasor) THD: per phase, displayed as a % of f ₁
------------	--

Accuracy:

HARMONICS:	1. f ₁ > 0.4pu: (0.20% + 0.035% / harmonic) of reading or 0.15% of 100%, whichever is greater 2. f ₁ < 0.4pu: as above plus %error of f ₁
THD:	1. f ₁ > 0.4pu: (0.25% + 0.035% / harmonic) of reading or 0.20% of 100%, whichever is greater 2. f ₁ < 0.4pu: as above plus %error of f ₁

FREQUENCY

Accuracy at	
V = 0.8 to 1.2 pu:	±0.01 Hz (when voltage signal is used for frequency measurement)
I = 0.1 to 0.25 pu:	±0.05 Hz
I > 0.25 pu:	±0.02 Hz (when current signal is used for frequency measurement)

DEMAND

Measurements:	Phases A, B, and C present and maximum measured currents 3-Phase Power (P, Q, and S) present and maximum measured currents
Accuracy:	±2.0%

2.2.5 INPUTS

AC CURRENT

CT rated primary:	1 to 50000 A
CT rated secondary:	1 A or 5 A by connection
Nominal frequency:	20 to 65 Hz
Relay burden:	< 0.2 VA at rated secondary
Conversion range:	
Standard CT:	0.02 to 46 × CT rating RMS symmetrical
Sensitive Ground module:	0.002 to 4.6 × CT rating RMS symmetrical
Current withstand:	20 ms at 250 times rated 1 sec. at 100 times rated continuous at 3 times rated

AC VOLTAGE

VT rated secondary:	50.0 to 240.0 V
VT ratio:	1.00 to 24000.00
Nominal frequency:	20 to 65 Hz
Relay burden:	< 0.25 VA at 120 V
Conversion range:	1 to 275 V
Voltage withstand:	continuous at 260 V to neutral 1 min./hr at 420 V to neutral

CONTACT INPUTS

Dry contacts:	1000 Ω maximum
Wet contacts:	300 V DC maximum
Selectable thresholds:	17 V, 33 V, 84 V, 166 V
Tolerance:	±10%
Contacts per common return:	4
Recognition time:	< 1 ms
Debounce time:	0.0 to 16.0 ms in steps of 0.5
Continuous current draw:	3 mA (when energized)

CONTACT INPUTS WITH AUTO-BURNISHING

Dry contacts:	1000 Ω maximum
Wet contacts:	300 V DC maximum
Selectable thresholds:	17 V, 33 V, 84 V, 166 V
Tolerance:	±10%
Contacts per common return:	2
Recognition time:	< 1 ms
Debounce time:	0.0 to 16.0 ms in steps of 0.5
Continuous current draw:	3 mA (when energized)
Auto-burnish impulse current:	50 to 70 mA
Duration of auto-burnish impulse:	25 to 50 ms

DCMA INPUTS

Current input (mA DC):	0 to -1, 0 to +1, -1 to +1, 0 to 5, 0 to 10, 0 to 20, 4 to 20 (programmable)
Input impedance:	379 Ω ±10%
Conversion range:	-1 to + 20 mA DC
Accuracy:	±0.2% of full scale
Type:	Passive

RTD INPUTS

Types (3-wire):	100 Ω Platinum, 100 & 120 Ω Nickel, 10 Ω Copper
Sensing current:	5 mA
Range:	-50 to +250°C
Accuracy:	±2°C
Isolation:	36 V pk-pk

IRIG-B INPUT

Amplitude modulation:	1 to 10 V pk-pk
DC shift:	TTL
Input impedance:	22 kΩ
Isolation:	2 kV

REMOTE INPUTS (MMS GOOSE)

Number of input points:	32, configured from 64 incoming bit pairs
Number of remote devices:	16
Default states on loss of comms.:	On, Off, Latest/Off, Latest/On

DIRECT INPUTS

Number of input points:	32
No. of remote devices:	16
Default states on loss of comms.:	On, Off, Latest/Off, Latest/On
Ring configuration:	Yes, No
Data rate:	64 or 128 kbps
CRC:	32-bit
CRC alarm:	
Responding to:	Rate of messages failing the CRC
Monitoring message count:	10 to 10000 in steps of 1
Alarm threshold:	1 to 1000 in steps of 1
Unreturned message alarm:	
Responding to:	Rate of unreturned messages in the ring configuration
Monitoring message count:	10 to 10000 in steps of 1
Alarm threshold:	1 to 1000 in steps of 1

TELEPROTECTION

Number of input points:	16
No. of remote devices:	3
Default states on loss of comms.:	On, Off, Latest/Off, Latest/On
Ring configuration:	No
Data rate:	64 or 128 kbps
CRC:	32-bit

2.2.6 POWER SUPPLY

LOW RANGE

Nominal DC voltage: 24 to 48 V
 Min/max DC voltage: 20 / 60 V
 Voltage loss hold-up: 20 ms duration at nominal
 NOTE: Low range is DC only.

HIGH RANGE

Nominal DC voltage: 125 to 250 V
 Min/max DC voltage: 88 / 300 V
 Nominal AC voltage: 100 to 240 V at 50/60 Hz
 Min/max AC voltage: 88 / 265 V at 25 to 100 Hz
 Voltage loss hold-up: 200 ms duration at nominal

ALL RANGES

Volt withstand: 2 × Highest Nominal Voltage for 10 ms
 Power consumption: typical = 15 to 20 W/VA
 maximum = 50 W/VA
 contact factory for exact order code consumption

INTERNAL FUSE

RATINGS
 Low range power supply: 8 A / 250 V
 High range power supply: 4 A / 250 V

INTERRUPTING CAPACITY

AC: 100 000 A RMS symmetrical
 DC: 10 000 A

2.2.7 OUTPUTS

FORM-A RELAY

Make and carry for 0.2 s: 30 A as per ANSI C37.90
 Carry continuous: 6 A
 Break (DC inductive, L/R = 40 ms):

VOLTAGE	CURRENT
24 V	1 A
48 V	0.5 A
125 V	0.3 A
250 V	0.2 A

Operate time: < 4 ms
 Contact material: silver alloy

LATCHING RELAY

Make and carry for 0.2 s: 30 A as per ANSI C37.90
 Carry continuous: 6 A
 Break at L/R of 40 ms: 0.25 A DC max.
 Operate time: < 4 ms
 Contact material: silver alloy
 Control: separate operate and reset inputs
 Control mode: operate-dominant or reset-dominant

FORM-A VOLTAGE MONITOR

Applicable voltage: approx. 15 to 250 V DC
 Trickle current: approx. 1 to 2.5 mA

FORM-A CURRENT MONITOR

Threshold current: approx. 80 to 100 mA

FORM-C AND CRITICAL FAILURE RELAY

Make and carry for 0.2 s: 30 A as per ANSI C37.90
 Carry continuous: 8 A
 Break (DC inductive, L/R = 40 ms):

VOLTAGE	CURRENT
24 V	1 A
48 V	0.5 A
125 V	0.3 A
250 V	0.2 A

Operate time: < 8 ms
 Contact material: silver alloy

FAST FORM-C RELAY

Make and carry: 0.1 A max. (resistive load)
 Minimum load impedance:

INPUT VOLTAGE	IMPEDANCE	
	2 W RESISTOR	1 W RESISTOR
250 V DC	20 KΩ	50 KΩ
120 V DC	5 KΩ	2 KΩ
48 V DC	2 KΩ	2 KΩ
24 V DC	2 KΩ	2 KΩ

Note: values for 24 V and 48 V are the same due to a required 95% voltage drop across the load impedance.

Operate time: < 0.6 ms
 Internal Limiting Resistor: 100 Ω, 2 W

SOLID-STATE OUTPUT RELAY

Operate and release time: <100 μs
 Maximum voltage: 265 V DC
 Maximum continuous current: 5 A at 45°C; 4 A at 65°C
 Make and carry:
 for 0.2 s: 30 A as per ANSI C37.90
 for 0.03 s: 300 A

Breaking capacity:

	UL508	Utility application (autoreclose scheme)	Industrial application
Operations/interval	5000 ops / 1 s-On, 9 s-Off 1000 ops / 0.5 s-On, 0.5 s-Off	5 ops / 0.2 s-On, 0.2 s-Off within 1 minute	10000 ops / 0.2 s-On, 30 s-Off
Break capability (0 to 250 V DC)	3.2 A L/R = 10 ms 1.6 A L/R = 20 ms 0.8 A L/R = 40 ms	10 A L/R = 40 ms	10 A L/R = 40 ms

IRIG-B OUTPUT

Amplitude:	10 V peak-peak RS485 level
Maximum load:	100 ohms
Time delay:	1 ms for AM input 40 μ s for DC-shift input
Isolation:	2 kV

CONTROL POWER EXTERNAL OUTPUT (FOR DRY CONTACT INPUT)

Capacity:	100 mA DC at 48 V DC
Isolation:	\pm 300 Vpk

REMOTE OUTPUTS (IEC 61850 GSSE/GOOSE)

Standard output points:	32
User output points:	32

DIRECT OUTPUTS

Output points:	32
----------------	----

DCMA OUTPUTS

Range:	-1 to 1 mA, 0 to 1 mA, 4 to 20 mA
Max. load resistance:	12 k Ω for -1 to 1 mA range 12 k Ω for 0 to 1 mA range 600 Ω for 4 to 20 mA range
Accuracy:	\pm 0.75% of full-scale for 0 to 1 mA range \pm 0.5% of full-scale for -1 to 1 mA range \pm 0.75% of full-scale for 0 to 20 mA range

99% Settling time to a step change: 100 ms

Isolation: 1.5 kV

Driving signal: any FlexAnalog quantity

Upper and lower limit for the driving signal: -90 to 90 pu in steps of 0.001

2.2.8 COMMUNICATIONS**RS232**

Front port: 19.2 kbps, Modbus[®] RTU

RS485

1 or 2 rear ports: Up to 115 kbps, Modbus[®] RTU, isolated together at 36 Vpk

Typical distance: 1200 m

Isolation: 2 kV

ETHERNET (FIBER)

PARAMETER	FIBER TYPE		
	10MB MULTI-MODE	100MB MULTI-MODE	100MB SINGLE-MODE
Wavelength	820 nm	1310 nm	1310 nm
Connector	ST	ST	SC
Transmit power	-20 dBm	-20 dBm	-15 dBm
Receiver sensitivity	-30 dBm	-30 dBm	-30 dBm
Power budget	10 dB	10 dB	15 dB
Maximum input power	-7.6 dBm	-14 dBm	-7 dBm
Typical distance	1.65 km	2 km	15 km
Duplex	full/half	full/half	full/half
Redundancy	yes	yes	yes

ETHERNET (COPPER)

Modes: 10 MB, 10/100 MB (auto-detect)

Connector: RJ45

SNTP clock synchronization error: <10 ms (typical)

2.2.9 INTER-RELAY COMMUNICATIONS

SHIELDED TWISTED-PAIR INTERFACE OPTIONS

INTERFACE TYPE	TYPICAL DISTANCE
RS422	1200 m
G.703	100 m

 **RS422 distance is based on transmitter power and does not take into consideration the clock source provided by the user.**

LINK POWER BUDGET

EMITTER, FIBER TYPE	TRANSMIT POWER	RECEIVED SENSITIVITY	POWER BUDGET
820 nm LED, Multimode	-20 dBm	-30 dBm	10 dB
1300 nm LED, Multimode	-21 dBm	-30 dBm	9 dB
1300 nm ELED, Singlemode	-21 dBm	-30 dBm	9 dB
1300 nm Laser, Singlemode	-1 dBm	-30 dBm	29 dB
1550 nm Laser, Singlemode	+5 dBm	-30 dBm	35 dB

 **These Power Budgets are calculated from the manufacturer's worst-case transmitter power and worst case receiver sensitivity.**

MAXIMUM OPTICAL INPUT POWER

EMITTER, FIBER TYPE	MAX. OPTICAL INPUT POWER
820 nm LED, Multimode	-7.6 dBm
1300 nm LED, Multimode	-11 dBm
1300 nm ELED, Singlemode	-14 dBm
1300 nm Laser, Singlemode	-14 dBm
1550 nm Laser, Singlemode	-14 dBm

TYPICAL LINK DISTANCE

EMITTER TYPE	FIBER TYPE	CONNECTOR TYPE	TYPICAL DISTANCE
820 nm LED	Multimode	ST	1.65 km
1300 nm LED	Multimode	ST	3.8 km
1300 nm ELED	Singlemode	ST	11.4 km
1300 nm Laser	Singlemode	ST	64 km
1550 nm Laser	Singlemode	ST	105 km

 **Typical distances listed are based on the following assumptions for system loss. As actual losses will vary from one installation to another, the distance covered by your system may vary.**

CONNECTOR LOSSES (TOTAL OF BOTH ENDS)

ST connector 2 dB

FIBER LOSSES

820 nm multimode 3 dB/km

1300 nm multimode 1 dB/km

1300 nm singlemode 0.35 dB/km

1550 nm singlemode 0.25 dB/km

Splice losses: One splice every 2 km, at 0.05 dB loss per splice.

SYSTEM MARGIN

3 dB additional loss added to calculations to compensate for all other losses.

Compensated difference in transmitting and receiving (channel asymmetry) channel delays using GPS satellite clock: 10 ms

2.2.10 ENVIRONMENTAL

AMBIENT TEMPERATURES

Operating: -40 to 60°C

Storage: -40 to 80°C

 **The LCD contrast may be impaired at temperatures less than -20°C.**

OTHER

Humidity (non-condensing): IEC 60068-2-30, 95%, Variant 1, 6 days

Altitude: Up to 2000 m

Installation Category: II

2.2.11 TYPE TESTS

Electrical fast transient:	ANSI/IEEE C37.90.1 IEC 61000-4-4 IEC 60255-22-4	Voltage dips/interruptions/vari- ations:	IEC 61000-4-11 IEC 60255-11
Oscillatory transient:	ANSI/IEEE C37.90.1 IEC 61000-4-12	Power frequency magnetic field immunity:	IEC 61000-4-8
Insulation resistance:	IEC 60255-5	Pulse magnetic field immunity:	IEC 61000-4-9
Dielectric strength:	IEC 60255-6 ANSI/IEEE C37.90	Vibration test (sinusoidal):	IEC 60255-21-1
Electrostatic discharge:	EN 61000-4-2	Shock and bump:	IEC 60255-21-2
Surge immunity:	EN 61000-4-5	Seismic:	IEC 60255-21-3 IEEE C37.98
RFI susceptibility:	ANSI/IEEE C37.90.2 IEC 61000-4-3 IEC 60255-22-3 Ontario Hydro C-5047-77	Cold:	IEC 60028-2-1, 16 h at -40°C
Conducted RFI:	IEC 61000-4-6	Dry heat:	IEC 60028-2-2, 16 h at 85°C



Type test report available upon request.

NOTE

2.2.12 PRODUCTION TESTS

THERMAL

Products go through an environmental test based upon an Accepted Quality Level (AQL) sampling process.

2.2.13 APPROVALS

APPROVALS

UL Listed for the USA and Canada

CE:

LVD 73/23/EEC: IEC 1010-1
EMC 81/336/EEC: EN 50081-2, EN 50082-2

2.2.14 MAINTENANCE

MOUNTING

Attach mounting brackets using 20 inch-pounds (± 2 inch-pounds) of torque.

CLEANING

Normally, cleaning is not required; but for situations where dust has accumulated on the faceplate display, a dry cloth can be used.



NOTE

Units that are stored in a de-energized state should be powered up once per year, for one hour continuously, to avoid deterioration of electrolytic capacitors.

3.1.1 PANEL CUTOUT

The relay is available as a 19-inch rack horizontal mount unit or as a reduced size (¾) vertical mount unit, with a removable faceplate. The modular design allows the relay to be easily upgraded or repaired by a qualified service person. The faceplate is hinged to allow easy access to the removable modules, and is itself removable to allow mounting on doors with limited rear depth. There is also a removable dust cover that fits over the faceplate, which must be removed when attempting to access the keypad or RS232 communications port.

The vertical and horizontal case dimensions are shown below, along with panel cutout details for panel mounting. When planning the location of your panel cutout, ensure that provision is made for the faceplate to swing open without interference to or from adjacent equipment.

The relay must be mounted such that the faceplate sits semi-flush with the panel or switchgear door, allowing the operator access to the keypad and the RS232 communications port. The relay is secured to the panel with the use of four screws supplied with the relay.

3

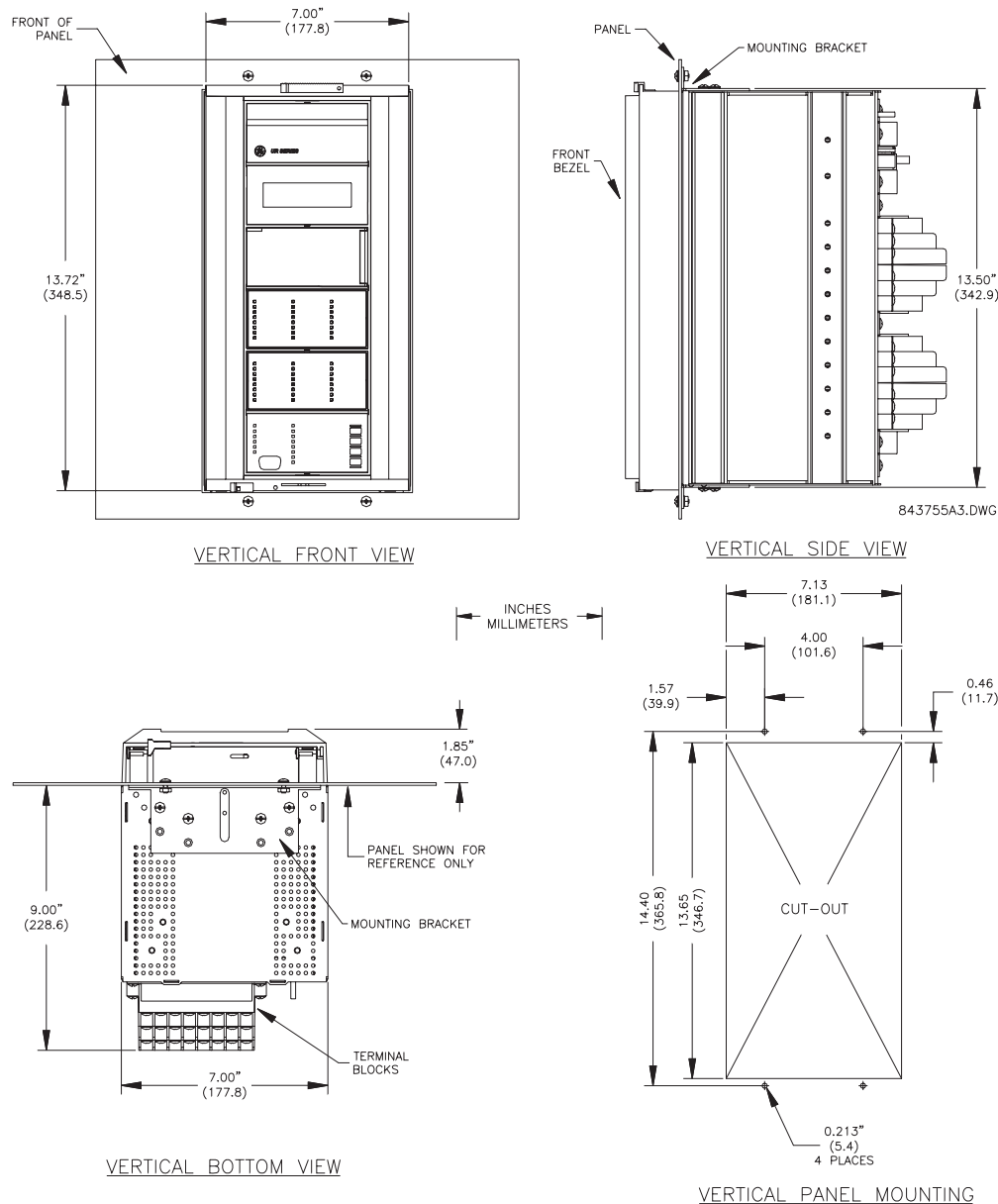

Figure 3-1: T60 VERTICAL MOUNTING AND DIMENSIONS

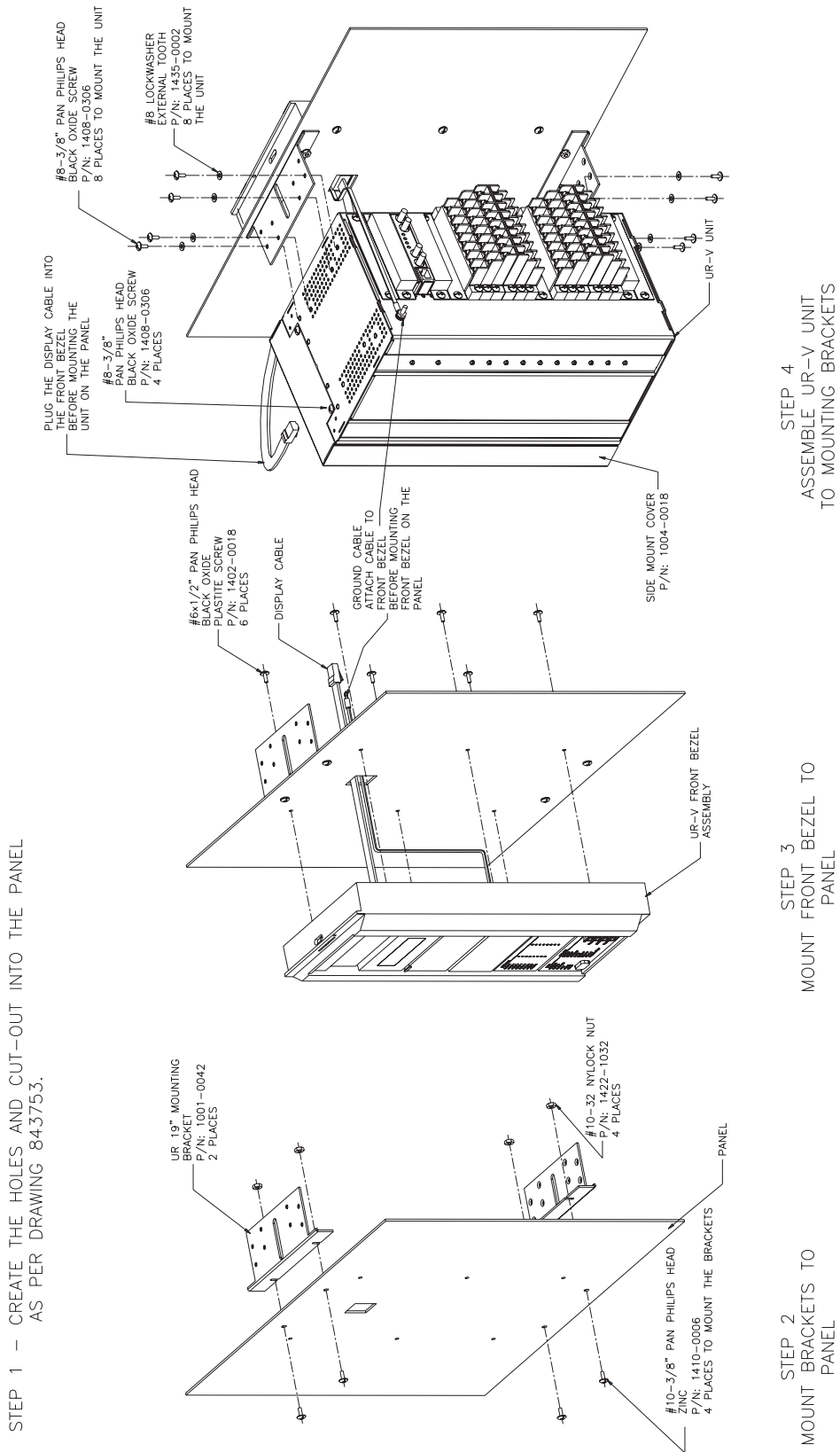

Figure 3-2: T60 VERTICAL SIDE MOUNTING INSTALLATION

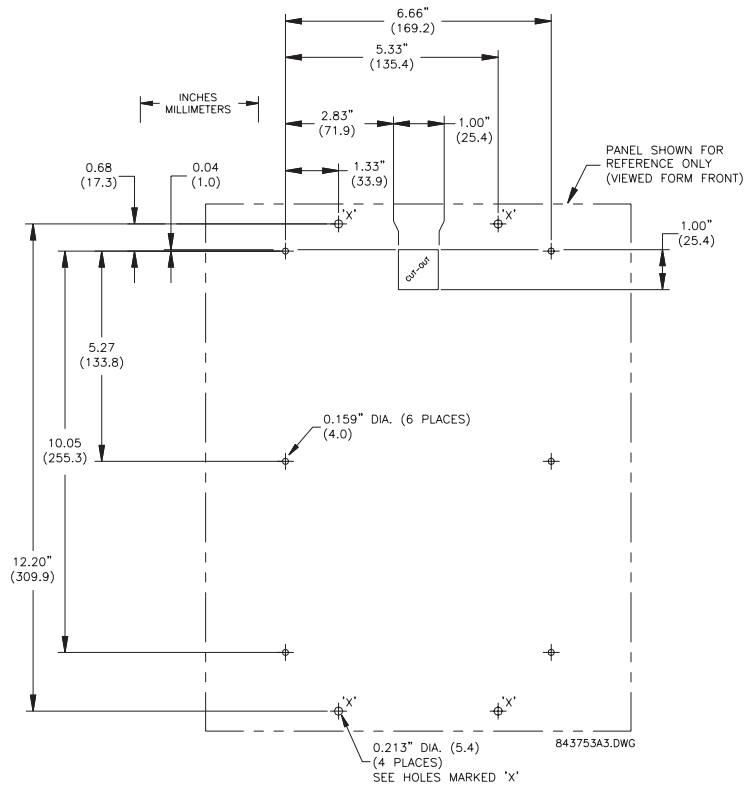

Figure 3-3: T60 VERTICAL SIDE MOUNTING REAR DIMENSIONS

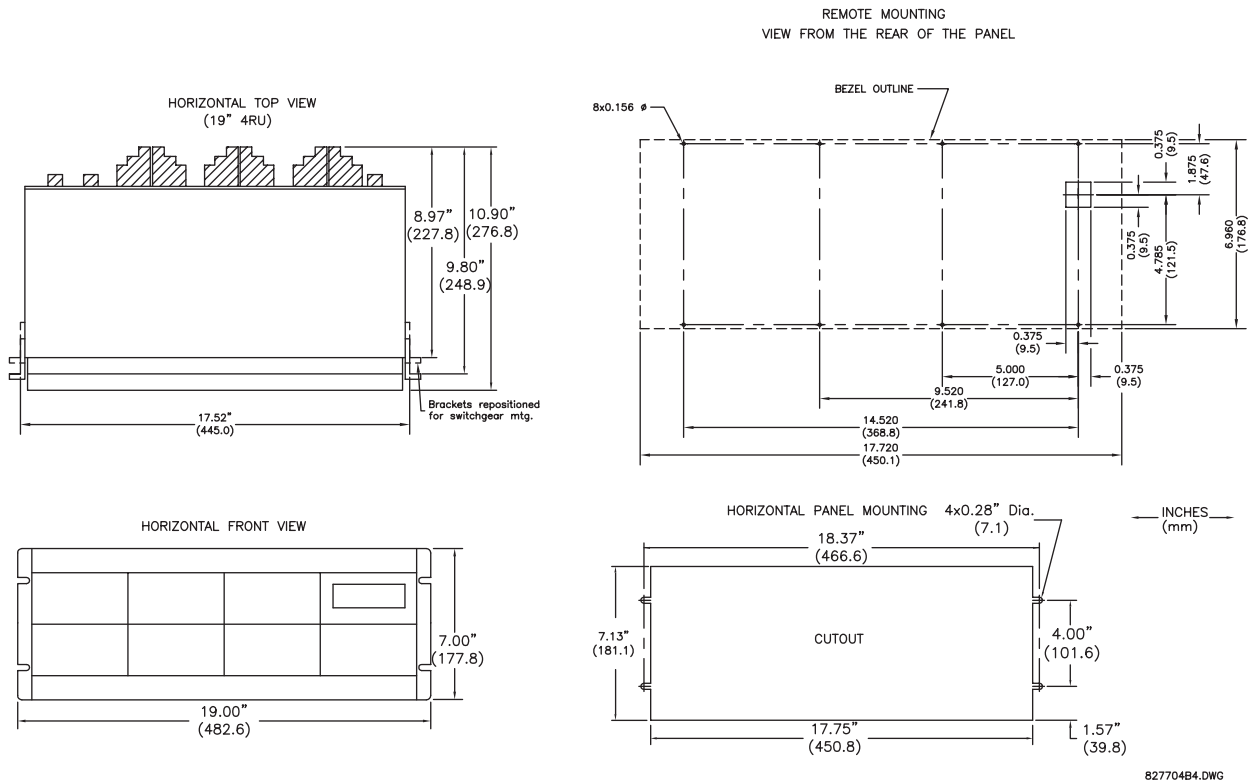

Figure 3-4: T60 HORIZONTAL MOUNTING AND DIMENSIONS

3.1.2 MODULE WITHDRAWAL AND INSERTION



Module withdrawal and insertion may only be performed when control power has been removed from the unit. Inserting an incorrect module type into a slot may result in personal injury, damage to the unit or connected equipment, or undesired operation!



Proper electrostatic discharge protection (i.e. a static strap) must be used when coming in contact with modules while the relay is energized!

The relay, being modular in design, allows for the withdrawal and insertion of modules. Modules must only be replaced with like modules in their original factory configured slots. The faceplate can be opened to the left, once the sliding latch on the right side has been pushed up, as shown below. This allows for easy accessibility of the modules for withdrawal.

3



Figure 3-5: UR MODULE WITHDRAWAL/INSERTION

- **MODULE WITHDRAWAL:** The ejector/inserter clips, located at the top and bottom of each module, must be pulled simultaneously to release the module for removal. Before performing this action, **control power must be removed from the relay**. Record the original location of the module to ensure that the same or replacement module is inserted into the correct slot. Modules with current input provide automatic shorting of external CT circuits.
- **MODULE INSERTION:** Ensure that the **correct** module type is inserted into the **correct** slot position. The ejector/inserter clips located at the top and at the bottom of each module must be in the disengaged position as the module is smoothly inserted into the slot. Once the clips have cleared the raised edge of the chassis, engage the clips simultaneously. When the clips have locked into position, the module will be fully inserted.



All CPU modules except the 9E are equipped with 10Base-T or 10Base-F Ethernet connectors. These connectors must be individually disconnected from the module before it can be removed from the chassis.



The version 4.0 release of the T60 relay includes new hardware (CPU and CT/VT modules). The new CPU modules are specified with the following order codes: 9E, 9G, 9H, 9J, 9K, 9L, 9M, 9N, 9P, 9R. The new CT/VT modules are specified with the following order codes: 8F, 8G, 8H, 8J.

The new CT/VT modules (8F, 8G, 8H, 8J) can only be used with new CPUs (9E, 9G, 9H, 9J, 9K, 9L, 9M, 9N, 9P, 9R); similarly, old CT/VT modules (8A, 8B, 8C, 8D) can only be used with old CPUs (9A, 9C, 9D). To prevent hardware mismatches, the new modules have blue labels and a warning sticker stating “**Attn.: Ensure CPU and DSP module label colors are the same!**”. In the event that there is a mismatch between the CPU and CT/VT module, the relay will not function and a **DSP ERROR** or **HARDWARE MISMATCH** error will be displayed.

All other input/output modules are compatible with the new hardware. Firmware versions 4.0x and higher are only compatible with the new CPU and CT/VT modules. Previous versions of the firmware (3.4x and earlier) are only compatible with the older CPU and CT/VT modules.

3.1.3 REAR TERMINAL LAYOUT



828748A1.CDR

Figure 3–6: REAR TERMINAL VIEW



Do not touch any rear terminals while the relay is energized!

The relay follows a convention with respect to terminal number assignments which are three characters long assigned in order by module slot position, row number, and column letter. Two-slot wide modules take their slot designation from the first slot position (nearest to CPU module) which is indicated by an arrow marker on the terminal block. See the following figure for an example of rear terminal assignments.

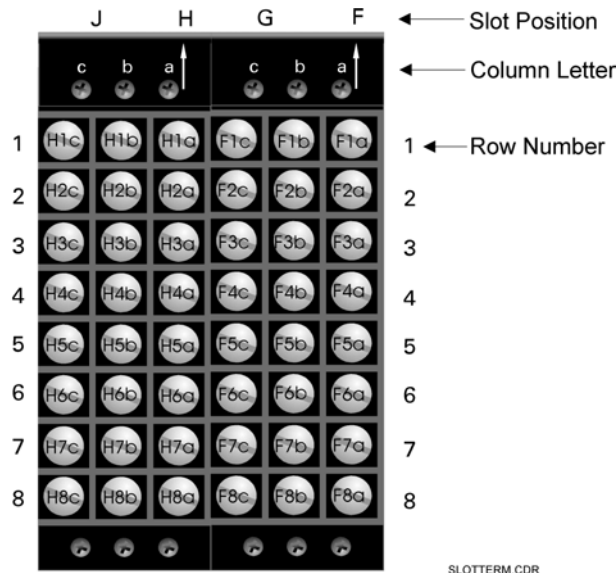

SLOTTERM.CDR

Figure 3–7: EXAMPLE OF MODULES IN F AND H SLOTS

3

3.2.1 TYPICAL WIRING

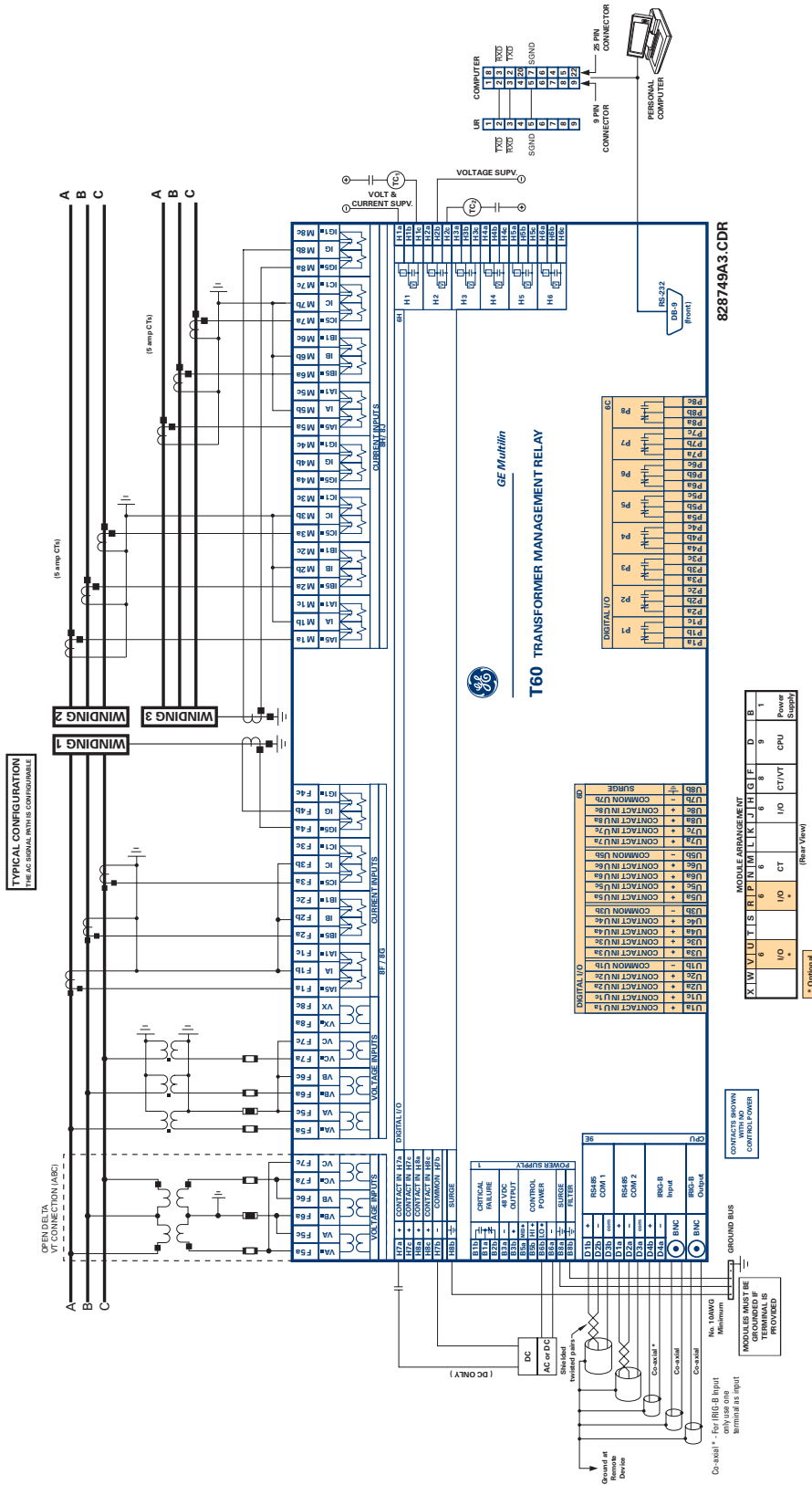

Figure 3-8: TYPICAL WIRING DIAGRAM

This diagram is based on the following order code: T60-E00-HCL-F8F-H6H-M8H-P6C-U6D. The purpose of this diagram is to provide an example of how the relay is typically wired, not specifically how to wire your own relay. Please refer to the following pages for examples to help you wire your relay correctly based on your own relay configuration and order code.



3.2.2 DIELECTRIC STRENGTH

The dielectric strength of the UR-series module hardware is shown in the following table:

Table 3–1: DIELECTRIC STRENGTH OF UR-SERIES MODULE HARDWARE

MODULE TYPE	MODULE FUNCTION	TERMINALS		DIELECTRIC STRENGTH (AC)
		FROM	TO	
1	Power Supply	High (+); Low (+); (–)	Chassis	2000 V AC for 1 minute
1	Power Supply	48 V DC (+) and (–)	Chassis	2000 V AC for 1 minute
1	Power Supply	Relay Terminals	Chassis	2000 V AC for 1 minute
2	Reserved	N/A	N/A	N/A
3	Reserved	N/A	N/A	N/A
4	Reserved	N/A	N/A	N/A
5	Analog Inputs/Outputs	All except 8b	Chassis	< 50 V DC
6	Digital Inputs/Outputs	All	Chassis	2000 V AC for 1 minute
7	G.703	All except 2b, 3a, 7b, 8a	Chassis	2000 V AC for 1 minute
	RS422	All except 6a, 7b, 8a	Chassis	< 50 V DC
8	CT/VT	All	Chassis	2000 V AC for 1 minute
9	CPU	All	Chassis	2000 V AC for 1 minute

Filter networks and transient protection clamps are used in the hardware to prevent damage caused by high peak voltage transients, radio frequency interference (RFI), and electromagnetic interference (EMI). These protective components **can be damaged** by application of the ANSI/IEEE C37.90 specified test voltage for a period longer than the specified one minute.

3.2.3 CONTROL POWER



CONTROL POWER SUPPLIED TO THE RELAY MUST BE CONNECTED TO THE MATCHING POWER SUPPLY RANGE OF THE RELAY. IF THE VOLTAGE IS APPLIED TO THE WRONG TERMINALS, DAMAGE MAY OCCUR!



The T60 relay, like almost all electronic relays, contains electrolytic capacitors. These capacitors are well known to be subject to deterioration over time if voltage is not applied periodically. Deterioration can be avoided by powering the relays up once a year.

The power supply module can be ordered for two possible voltage ranges, with or without a redundant power option. Each range has a dedicated input connection for proper operation. The ranges are as shown below (see the *Technical Specifications* section of Chapter 2 for additional details):

LO range: 24 to 48 V (DC only) nominal
 HI range: 125 to 250 V nominal

The power supply module provides power to the relay and supplies power for dry contact input connections.

The power supply module provides 48 V DC power for dry contact input connections and a critical failure relay (see the *Typical Wiring Diagram* earlier). The critical failure relay is a Form-C that will be energized once control power is applied and the relay has successfully booted up with no critical self-test failures. If on-going self-test diagnostic checks detect a critical failure (see the *Self-Test Errors* table in Chapter 7) or control power is lost, the relay will de-energize.

For high reliability systems, the T60 has a redundant option in which two T60 power supplies are placed in parallel on the bus. If one of the power supplies become faulted, the second power supply will assume the full load of the relay without any interruptions. Each power supply has a green LED on the front of the module to indicate it is functional. The critical fail relay of the module will also indicate a faulted power supply.

An LED on the front of the module shows the status of the power supply:

LED INDICATION	POWER SUPPLY
ON	OK
ON / OFF CYCLING	Failure
OFF	Failure

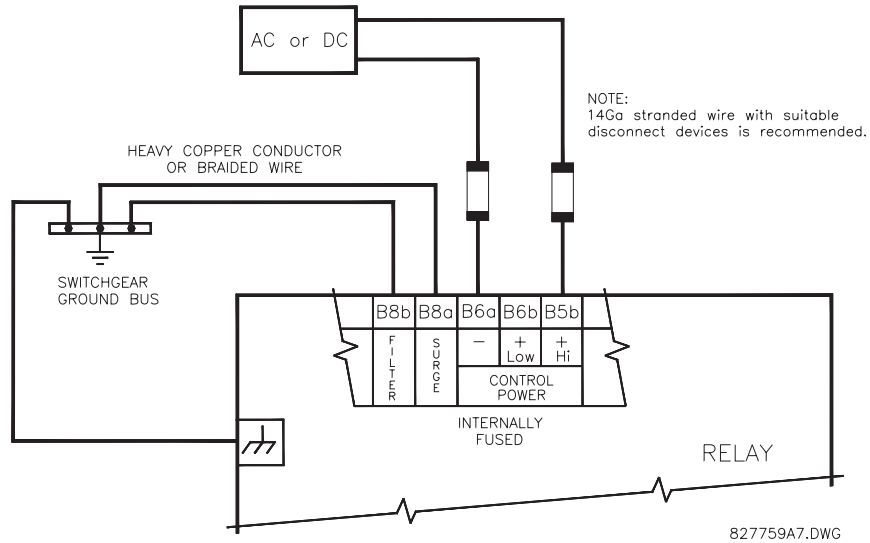

Figure 3-9: CONTROL POWER CONNECTION

3.2.4 CT/VT MODULES

A CT/VT module may have voltage inputs on Channels 1 through 4 inclusive, or Channels 5 through 8 inclusive. Channels 1 and 5 are intended for connection to Phase A, and are labeled as such in the relay. Channels 2 and 6 are intended for connection to Phase B, and are labeled as such in the relay. Channels 3 and 7 are intended for connection to Phase C and are labeled as such in the relay. Channels 4 and 8 are intended for connection to a single phase source. If voltage, this channel is labelled the auxiliary voltage (VX). If current, this channel is intended for connection to a CT between a system neutral and ground, and is labelled the ground current (IG).

a) CT INPUTS



VERIFY THAT THE CONNECTION MADE TO THE RELAY NOMINAL CURRENT OF 1 A OR 5 A MATCHES THE SECONDARY RATING OF THE CONNECTED CTs. UNMATCHED CTs MAY RESULT IN EQUIPMENT DAMAGE OR INADEQUATE PROTECTION.

The CT/VT module may be ordered with a standard ground current input that is the same as the phase current inputs (Type 8F) or with a sensitive ground input (Type 8G) which is 10 times more sensitive (see the Technical Specifications section for additional details). Each AC current input has an isolating transformer and an automatic shorting mechanism that shorts the input when the module is withdrawn from the chassis. There are no internal ground connections on the current inputs. Current transformers with 1 to 50000 A primaries and 1 A or 5 A secondaries may be used.

CT connections for both ABC and ACB phase rotations are identical as shown in the *Typical Wiring Diagram*.

The exact placement of a zero-sequence CT so that ground fault current will be detected is shown below. Twisted pair cabling on the zero-sequence CT is recommended.

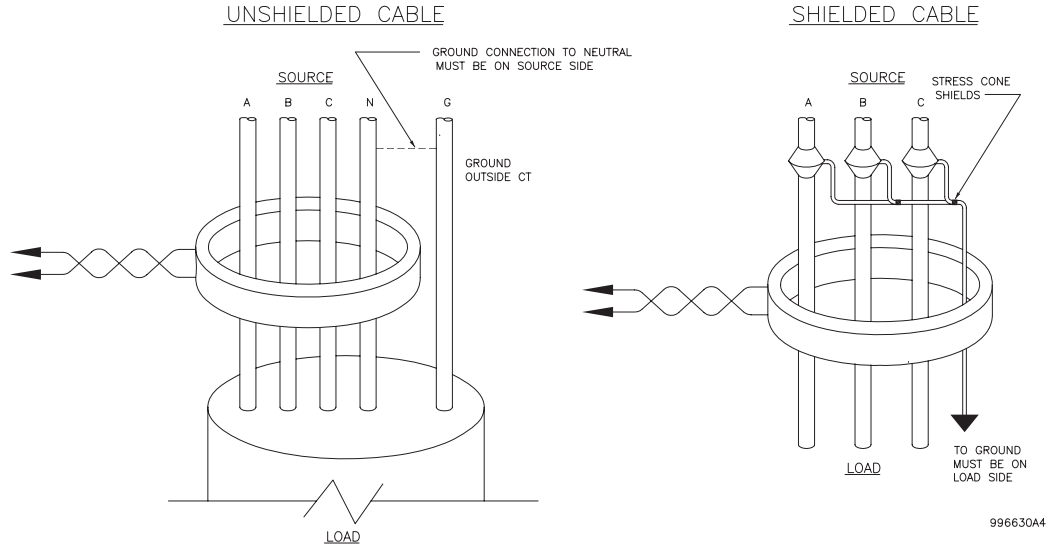

Figure 3-10: ZERO-SEQUENCE CORE BALANCE CT INSTALLATION

b) VT INPUTS

The phase voltage channels are used for most metering and protection purposes. The auxiliary voltage channel is used as input for the Synchrocheck and Volts/Hertz features.

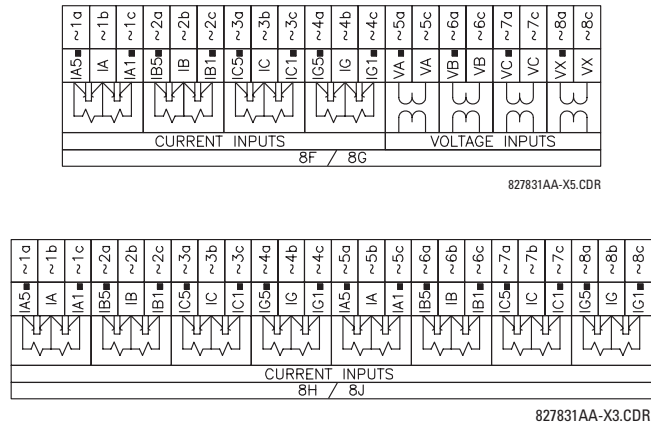

Figure 3-11: CT/VT MODULE WIRING



NOTE Wherever a tilde “~” symbol appears, substitute with the Slot Position of the module.

3.2.5 CONTACT INPUTS/OUTPUTS

Every digital input/output module has 24 terminal connections. They are arranged as three terminals per row, with eight rows in total. A given row of three terminals may be used for the outputs of one relay. For example, for Form-C relay outputs, the terminals connect to the normally open (NO), normally closed (NC), and common contacts of the relay. For a Form-A output, there are options of using current or voltage detection for feature supervision, depending on the module ordered. The terminal configuration for contact inputs is different for the two applications.

The digital inputs are grouped with a common return. The T60 has two versions of grouping: four inputs per common return and two inputs per common return. When a digital input/output module is ordered, four inputs per common is used. The four inputs per common allows for high-density inputs in combination with outputs, with a compromise of four inputs sharing one common. If the inputs must be isolated per row, then two inputs per common return should be selected (4D module).

The tables and diagrams on the following pages illustrate the module types (6A, etc.) and contact arrangements that may be ordered for the relay. Since an entire row is used for a single contact output, the name is assigned using the module slot position and row number. However, since there are two contact inputs per row, these names are assigned by module slot position, row number, and column position.

UR-SERIES FORM-A / SOLID STATE (SSR) OUTPUT CONTACTS:

Some Form-A/SSR outputs include circuits to monitor the DC voltage across the output contact when it is open, and the DC current through the output contact when it is closed. Each of the monitors contains a level detector whose output is set to logic “On = 1” when the current in the circuit is above the threshold setting. The voltage monitor is set to “On = 1” when the current is above about 1 to 2.5 mA, and the current monitor is set to “On = 1” when the current exceeds about 80 to 100 mA. The voltage monitor is intended to check the health of the overall trip circuit, and the current monitor can be used to seal-in the output contact until an external contact has interrupted current flow. The block diagrams of the circuits are below above for the Form-A outputs with:

- a) optional voltage monitor
- b) optional current monitor
- c) with no monitoring

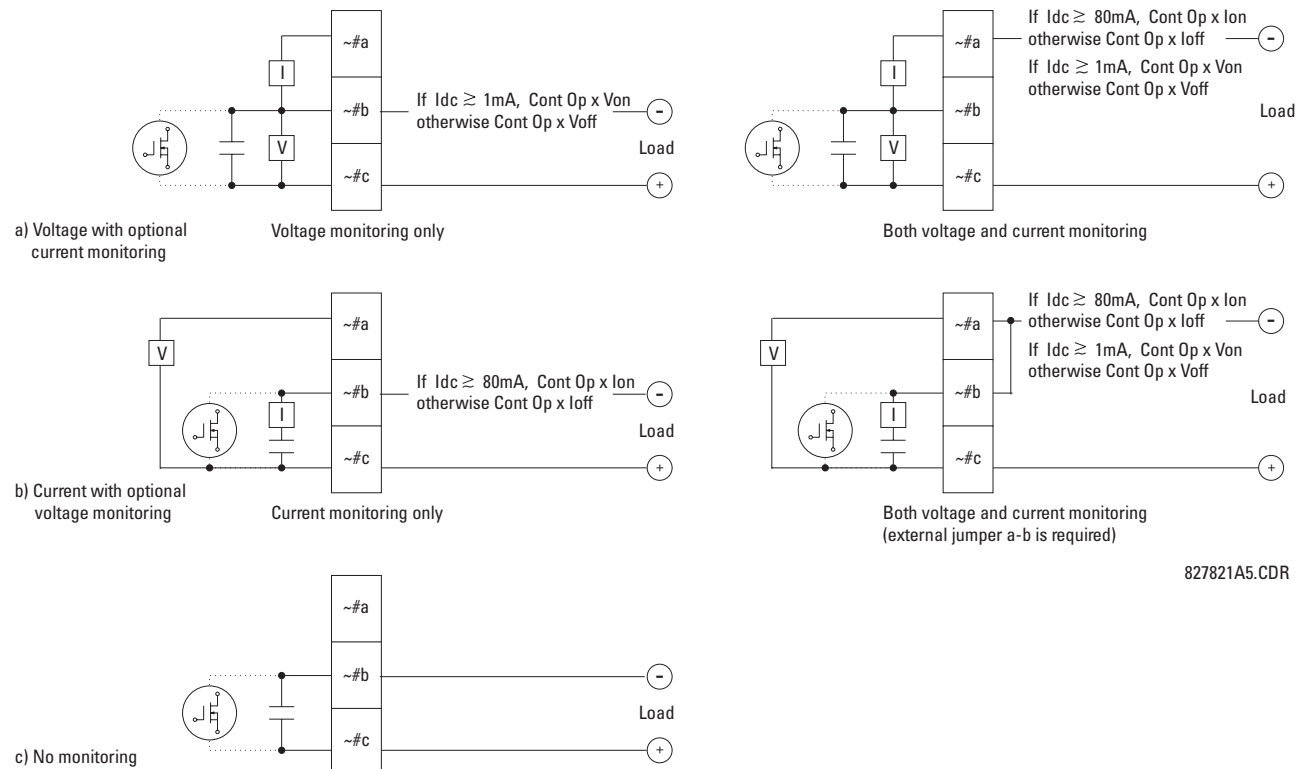

Figure 3-12: FORM-A / SOLID STATE CONTACT FUNCTIONS

The operation of voltage and current monitors is reflected with the corresponding FlexLogic™ operands (Cont Op # Von, Cont Op # Voff, Cont Op # Ion, and Cont Op # Ioff) which can be used in protection, control and alarm logic. The typical application of the voltage monitor is breaker trip circuit integrity monitoring; a typical application of the current monitor is seal-in of the control command. Refer to the *Digital Elements* section of Chapter 5 for an example of how Form-A/SSR contacts can be applied for breaker trip circuit integrity monitoring.



Relay contacts must be considered unsafe to touch when the unit is energized! If the relay contacts need to be used for low voltage accessible applications, it is the customer's responsibility to ensure proper insulation levels!



USE OF FORM-A/SSR OUTPUTS IN HIGH IMPEDANCE CIRCUITS

For Form-A/SSR output contacts internally equipped with a voltage measuring circuit across the contact, the circuit has an impedance that can cause a problem when used in conjunction with external high input impedance monitoring equipment such as modern relay test set trigger circuits. These monitoring circuits may continue to read the Form-A contact as being closed after it has closed and subsequently opened, when measured as an impedance.

The solution to this problem is to use the voltage measuring trigger input of the relay test set, and connect the Form-A contact through a voltage-dropping resistor to a DC voltage source. If the 48 V DC output of the power supply is used as a source, a 500 Ω, 10 W resistor is appropriate. In this configuration, the voltage across either the Form-A contact or the resistor can be used to monitor the state of the output.



Wherever a tilde “~” symbol appears, substitute with the slot position of the module; wherever a number sign “#” appears, substitute the contact number



When current monitoring is used to seal-in the Form-A/SSR contact outputs, the FlexLogic™ operand driving the contact output should be given a reset delay of 10 ms to prevent damage of the output contact (in situations when the element initiating the contact output is bouncing, at values in the region of the pickup value).

Table 3–2: DIGITAL INPUT/OUTPUT MODULE ASSIGNMENTS

~6A MODULE		~6B MODULE		~6C MODULE		~6D MODULE	
TERMINAL ASSIGNMENT	OUTPUT OR INPUT	TERMINAL ASSIGNMENT	OUTPUT OR INPUT	TERMINAL ASSIGNMENT	OUTPUT	TERMINAL ASSIGNMENT	OUTPUT
~1	Form-A	~1	Form-A	~1	Form-C	~1a, ~1c	2 Inputs
~2	Form-A	~2	Form-A	~2	Form-C	~2a, ~2c	2 Inputs
~3	Form-C	~3	Form-C	~3	Form-C	~3a, ~3c	2 Inputs
~4	Form-C	~4	Form-C	~4	Form-C	~4a, ~4c	2 Inputs
~5a, ~5c	2 Inputs	~5	Form-C	~5	Form-C	~5a, ~5c	2 Inputs
~6a, ~6c	2 Inputs	~6	Form-C	~6	Form-C	~6a, ~6c	2 Inputs
~7a, ~7c	2 Inputs	~7a, ~7c	2 Inputs	~7	Form-C	~7a, ~7c	2 Inputs
~8a, ~8c	2 Inputs	~8a, ~8c	2 Inputs	~8	Form-C	~8a, ~8c	2 Inputs

~6E MODULE		~6F MODULE		~6G MODULE		~6H MODULE	
TERMINAL ASSIGNMENT	OUTPUT OR INPUT	TERMINAL ASSIGNMENT	OUTPUT	TERMINAL ASSIGNMENT	OUTPUT OR INPUT	TERMINAL ASSIGNMENT	OUTPUT OR INPUT
~1	Form-C	~1	Fast Form-C	~1	Form-A	~1	Form-A
~2	Form-C	~2	Fast Form-C	~2	Form-A	~2	Form-A
~3	Form-C	~3	Fast Form-C	~3	Form-A	~3	Form-A
~4	Form-C	~4	Fast Form-C	~4	Form-A	~4	Form-A
~5a, ~5c	2 Inputs	~5	Fast Form-C	~5a, ~5c	2 Inputs	~5	Form-A
~6a, ~6c	2 Inputs	~6	Fast Form-C	~6a, ~6c	2 Inputs	~6	Form-A
~7a, ~7c	2 Inputs	~7	Fast Form-C	~7a, ~7c	2 Inputs	~7a, ~7c	2 Inputs
~8a, ~8c	2 Inputs	~8	Fast Form-C	~8a, ~8c	2 Inputs	~8a, ~8c	2 Inputs

~6K MODULE	
TERMINAL ASSIGNMENT	OUTPUT
~1	Form-C
~2	Form-C
~3	Form-C
~4	Form-C
~5	Fast Form-C
~6	Fast Form-C
~7	Fast Form-C
~8	Fast Form-C

~6L MODULE	
TERMINAL ASSIGNMENT	OUTPUT OR INPUT
~1	Form-A
~2	Form-A
~3	Form-C
~4	Form-C
~5a, ~5c	2 Inputs
~6a, ~6c	2 Inputs
~7a, ~7c	2 Inputs
~8a, ~8c	2 Inputs

~6M MODULE	
TERMINAL ASSIGNMENT	OUTPUT OR INPUT
~1	Form-A
~2	Form-A
~3	Form-C
~4	Form-C
~5	Form-C
~6	Form-C
~7a, ~7c	2 Inputs
~8a, ~8c	2 Inputs

~6N MODULE	
TERMINAL ASSIGNMENT	OUTPUT OR INPUT
~1	Form-A
~2	Form-A
~3	Form-A
~4	Form-A
~5a, ~5c	2 Inputs
~6a, ~6c	2 Inputs
~7a, ~7c	2 Inputs
~8a, ~8c	2 Inputs

~6P MODULE	
TERMINAL ASSIGNMENT	OUTPUT OR INPUT
~1	Form-A
~2	Form-A
~3	Form-A
~4	Form-A
~5	Form-A
~6	Form-A
~7a, ~7c	2 Inputs
~8a, ~8c	2 Inputs

~6R MODULE	
TERMINAL ASSIGNMENT	OUTPUT OR INPUT
~1	Form-A
~2	Form-A
~3	Form-C
~4	Form-C
~5a, ~5c	2 Inputs
~6a, ~6c	2 Inputs
~7a, ~7c	2 Inputs
~8a, ~8c	2 Inputs

~6S MODULE	
TERMINAL ASSIGNMENT	OUTPUT OR INPUT
~1	Form-A
~2	Form-A
~3	Form-C
~4	Form-C
~5	Form-C
~6	Form-C
~7a, ~7c	2 Inputs
~8a, ~8c	2 Inputs

~6T MODULE	
TERMINAL ASSIGNMENT	OUTPUT OR INPUT
~1	Form-A
~2	Form-A
~3	Form-A
~4	Form-A
~5a, ~5c	2 Inputs
~6a, ~6c	2 Inputs
~7a, ~7c	2 Inputs
~8a, ~8c	2 Inputs

~6U MODULE	
TERMINAL ASSIGNMENT	OUTPUT OR INPUT
~1	Form-A
~2	Form-A
~3	Form-A
~4	Form-A
~5	Form-A
~6	Form-A
~7a, ~7c	2 Inputs
~8a, ~8c	2 Inputs

~67 MODULE	
TERMINAL ASSIGNMENT	OUTPUT
~1	Form-A
~2	Form-A
~3	Form-A
~4	Form-A
~5	Form-A
~6	Form-A
~7	Form-A
~8	Form-A

~4A MODULE	
TERMINAL ASSIGNMENT	OUTPUT
~1	Not Used
~2	Solid-State
~3	Not Used
~4	Solid-State
~5	Not Used
~6	Solid-State
~7	Not Used
~8	Solid-State

~4B MODULE	
TERMINAL ASSIGNMENT	OUTPUT
~1	Not Used
~2	Solid-State
~3	Not Used
~4	Solid-State
~5	Not Used
~6	Solid-State
~7	Not Used
~8	Solid-State

~4C MODULE	
TERMINAL ASSIGNMENT	OUTPUT
~1	Not Used
~2	Solid-State
~3	Not Used
~4	Solid-State
~5	Not Used
~6	Solid-State
~7	Not Used
~8	Solid-State

~4D MODULE	
TERMINAL ASSIGNMENT	OUTPUT
~1a, ~1c	2 Inputs
~2a, ~2c	2 Inputs
~3a, ~3c	2 Inputs
~4a, ~4c	2 Inputs
~5a, ~5c	2 Inputs
~6a, ~6c	2 Inputs
~7a, ~7c	2 Inputs
~8a, ~8c	2 Inputs

~4L MODULE	
TERMINAL ASSIGNMENT	OUTPUT
~1	2 Outputs
~2	2 Outputs
~3	2 Outputs
~4	2 Outputs
~5	2 Outputs
~6	2 Outputs
~7	2 Outputs
~8	Not Used

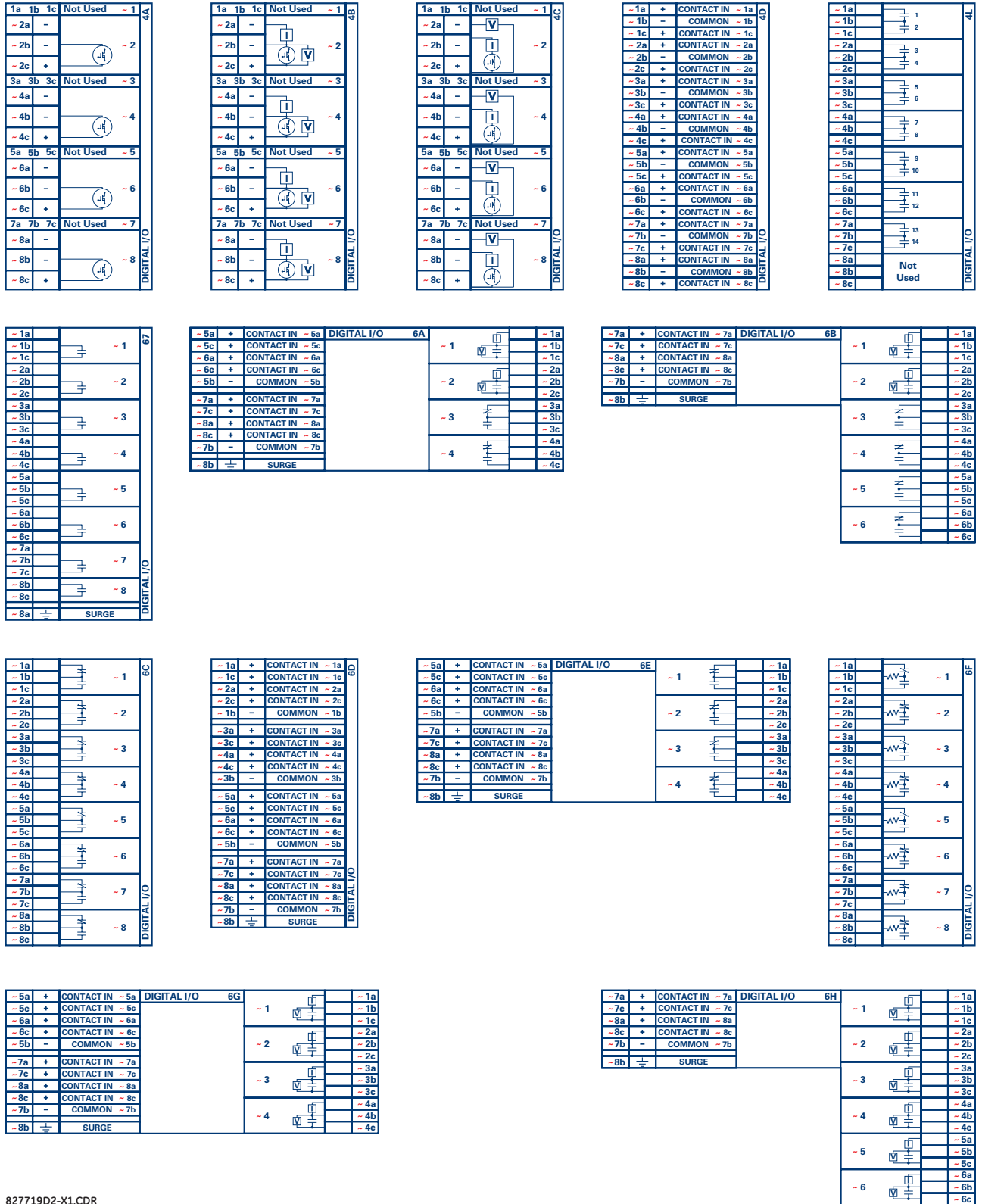

3

Figure 3-13: DIGITAL INPUT/OUTPUT MODULE WIRING (1 of 2)

827719D2-X1.CDR

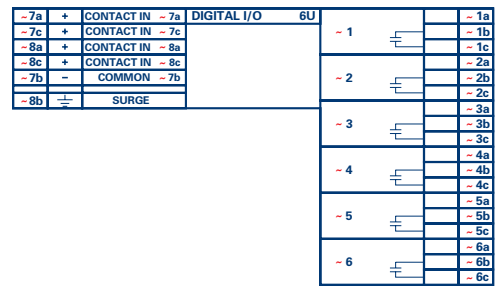
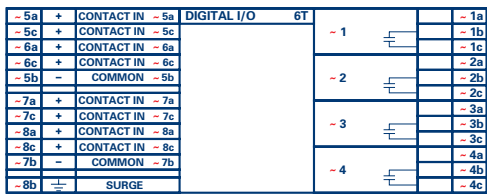
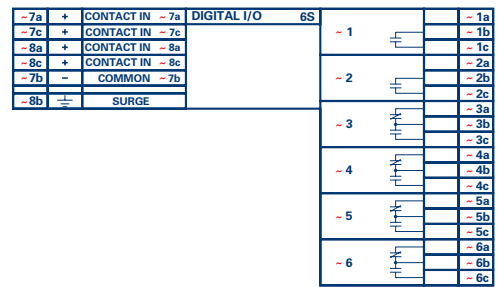
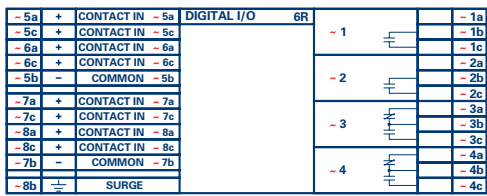
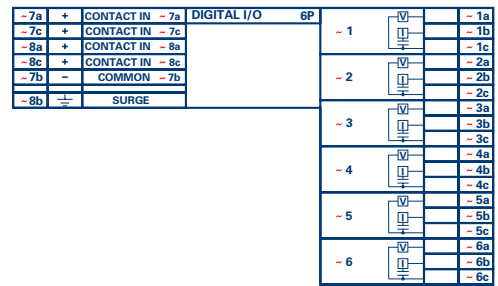
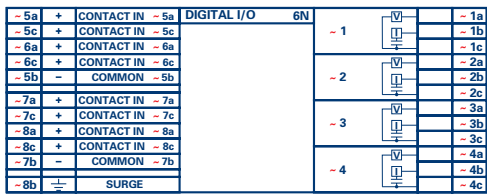
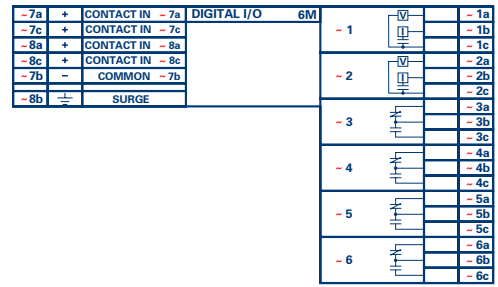
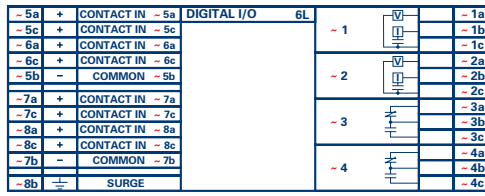
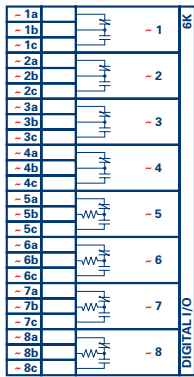

827719D2-X1.CDR

Figure 3-14: DIGITAL INPUT/OUTPUT MODULE WIRING (2 of 2)



CORRECT POLARITY MUST BE OBSERVED FOR ALL CONTACT INPUT AND SOLID STATE OUTPUT CONNECTIONS FOR PROPER FUNCTIONALITY.

CONTACT INPUTS:

A dry contact has one side connected to Terminal B3b. This is the positive 48 V DC voltage rail supplied by the power supply module. The other side of the dry contact is connected to the required contact input terminal. Each contact input group has its own common (negative) terminal which must be connected to the DC negative terminal (B3a) of the power supply module. When a dry contact closes, a current of 1 to 3 mA will flow through the associated circuit.

A wet contact has one side connected to the positive terminal of an external DC power supply. The other side of this contact is connected to the required contact input terminal. In addition, the negative side of the external source must be be connected to the relay common (negative) terminal of each contact input group. The maximum external source voltage for this arrangement is 300 V DC.

The voltage threshold at which each group of four contact inputs will detect a closed contact input is programmable as 17 V DC for 24 V sources, 33 V DC for 48 V sources, 84 V DC for 110 to 125 V sources, and 166 V DC for 250 V sources.

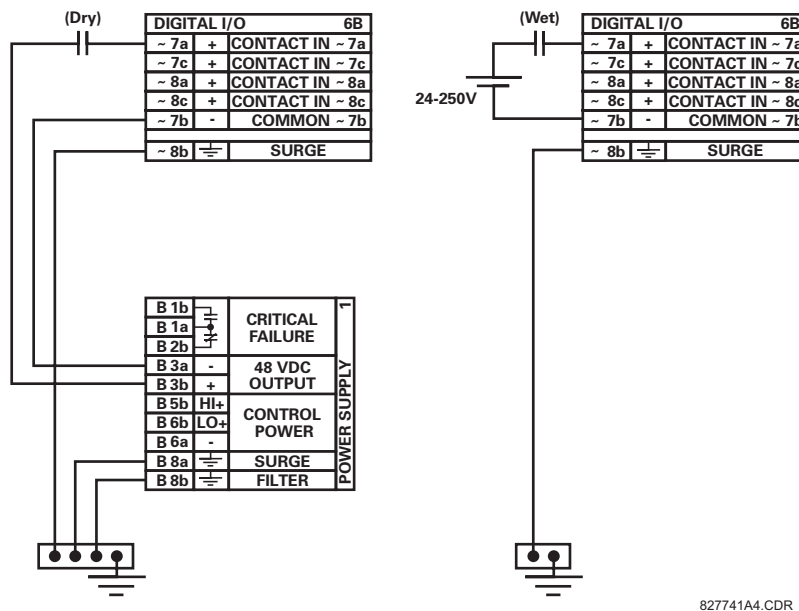

827741A4.CDR

Figure 3-15: DRY AND WET CONTACT INPUT CONNECTIONS



Wherever a tilde “~” symbol appears, substitute with the Slot Position of the module.

CONTACT OUTPUTS:

Contact outputs may be ordered as Form-A or Form-C. The Form A contacts may be connected for external circuit supervision. These contacts are provided with voltage and current monitoring circuits used to detect the loss of DC voltage in the circuit, and the presence of DC current flowing through the contacts when the Form-A contact closes. If enabled, the current monitoring can be used as a seal-in signal to ensure that the Form-A contact does not attempt to break the energized inductive coil circuit and weld the output contacts.



There is no provision in the relay to detect a DC ground fault on 48 V DC control power external output. We recommend using an external DC supply.

USE OF CONTACT INPUTS WITH AUTO-BURNISHING:

The contact inputs sense a change of the state of the external device contact based on the measured current. When external devices are located in a harsh industrial environment (either outdoor or indoor), their contacts can be exposed to various types of contamination. Normally, there is a thin film of insulating sulfidation, oxidation, or contaminants on the surface of the contacts, sometimes making it difficult or impossible to detect a change of the state. This film must be removed to establish circuit continuity – an impulse of higher than normal current can accomplish this.

The contact inputs with auto-burnish create a high current impulse when the threshold is reached to burn off this oxidation layer as a maintenance to the contacts. Afterwards the contact input current is reduced to a steady-state current. The impulse will have a 5 second delay after a contact input changes state.

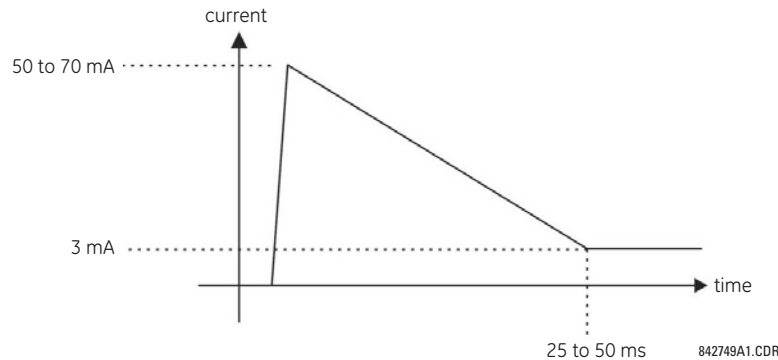

Figure 3-16: CURRENT THROUGH CONTACT INPUTS WITH AUTO-BURNISHING

Regular contact inputs limit current to less than 3 mA to reduce station battery burden. In contrast, contact inputs with auto-burnishing allow currents up to 50 to 70 mA at the first instance when the change of state was sensed. Then, within 25 to 50 ms, this current is slowly reduced to 3 mA as indicated above. The 50 to 70 mA peak current burns any film on the contacts, allowing for proper sensing of state changes. If the external device contact is bouncing, the auto-burnishing starts when external device contact bouncing is over.

Another important difference between the auto-burnishing input module and the regular input modules is that only two contact inputs have common ground, as opposed to four contact inputs sharing one common ground (refer to the *Digital Input/Output Module Wiring* diagrams). This is beneficial when connecting contact inputs to separate voltage sources. Consequently, the threshold voltage setting is also defined per group of two contact inputs.

The auto-burnish feature can be disabled or enabled using the DIP switches found on each daughter card. There is a DIP switch for each contact, for a total of 16 inputs.

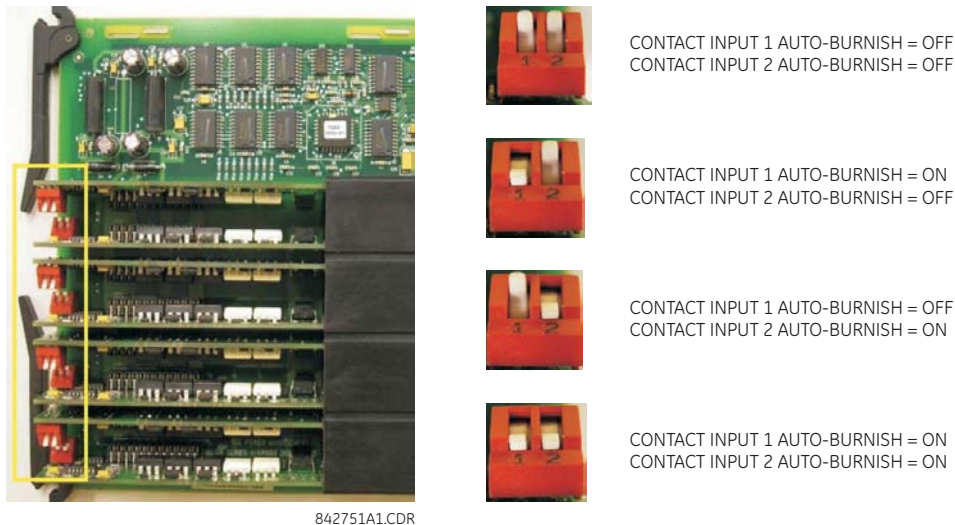

Figure 3-17: AUTO-BURNISH DIP SWITCHES



The auto-burnish circuitry has an internal fuse for safety purposes. During regular maintenance, the auto-burnish functionality can be checked using an oscilloscope.

NOTE

3.2.6 TRANSDUCER INPUTS/OUTPUTS

Transducer input modules can receive input signals from external dcmA output transducers (dcmA In) or resistance temperature detectors (RTD). Hardware and software is provided to receive signals from these external transducers and convert these signals into a digital format for use as required.

Transducer output modules provide DC current outputs in several standard dcmA ranges. Software is provided to configure virtually any analog quantity used in the relay to drive the analog outputs.

Every transducer input/output module has a total of 24 terminal connections. These connections are arranged as three terminals per row with a total of eight rows. A given row may be used for either inputs or outputs, with terminals in column "a" having positive polarity and terminals in column "c" having negative polarity. Since an entire row is used for a single input/output channel, the name of the channel is assigned using the module slot position and row number.

Each module also requires that a connection from an external ground bus be made to Terminal 8b. The current outputs require a twisted-pair shielded cable, where the shield is grounded at one end only. The figure below illustrates the transducer module types (5A, 5C, 5D, 5E, and 5F) and channel arrangements that may be ordered for the relay.



Wherever a tilde “~” symbol appears, substitute with the Slot Position of the module.

~1a	+	dcmA In	~1	5A
~1c	-			
~2a	+	dcmA In	~2	
~2c	-			
~3a	+	dcmA In	~3	
~3c	-			
~4a	+	dcmA In	~4	
~4c	-			
~5a	+	dcmA Out	~5	ANALOG I/O
~5c	-			
~6a	+	dcmA Out	~6	
~6c	-			
~7a	+	dcmA Out	~7	
~7c	-			
~8a	+	dcmA Out	~8	
~8c	-			
~8b	⏏	SURGE		

~1a	Hot	RTD	~1	5C
~1c	Comp			
~1b	Return	for RTD ~1& ~2		
~2a	Hot	RTD	~2	
~2c	Comp			
~3a	Hot	RTD	~3	
~3c	Comp			
~3b	Return	for RTD ~3& ~4		
~4a	Hot	RTD	~4	ANALOG I/O
~4c	Comp			
~5a	Hot	RTD	~5	
~5c	Comp			
~5b	Return	for RTD ~5& ~6		
~6a	Hot	RTD	~6	
~6c	Comp			
~7a	Hot	RTD	~7	
~7c	Comp			
~7b	Return	for RTD ~7& ~8		
~8a	Hot	RTD	~8	
~8c	Comp			
~8b	⏏	SURGE		

~1a	Hot	RTD	~1	5D
~1c	Comp			
~1b	Return	for RTD ~1& ~2		
~2a	Hot	RTD	~2	
~2c	Comp			
~3a	Hot	RTD	~3	
~3c	Comp			
~3b	Return	for RTD ~3& ~4		
~4a	Hot	RTD	~4	ANALOG I/O
~4c	Comp			
~5a	+	dcmA Out	~5	
~5c	-			
~6a	+	dcmA Out	~6	
~6c	-			
~7a	+	dcmA Out	~7	
~7c	-			
~8a	+	dcmA Out	~8	
~8c	-			
~8b	⏏	SURGE		

~1a	+	dcmA In	~1	5E
~1c	-			
~2a	+	dcmA In	~2	
~2c	-			
~3a	+	dcmA In	~3	
~3c	-			
~4a	+	dcmA In	~4	
~4c	-			
~5a	Hot	RTD	~5	ANALOG I/O
~5c	Comp			
~5b	Return	for RTD ~5& ~6		
~6a	Hot	RTD	~6	
~6c	Comp			
~7a	Hot	RTD	~7	
~7c	Comp			
~7b	Return	for RTD ~7& ~8		
~8a	Hot	RTD	~8	
~8c	Comp			
~8b	⏏	SURGE		

~1a	+	dcmA In	~1	5F
~1c	-			
~2a	+	dcmA In	~2	
~2c	-			
~3a	+	dcmA In	~3	
~3c	-			
~4a	+	dcmA In	~4	
~4c	-			
~5a	+	dcmA In	~5	ANALOG I/O
~5c	-			
~6a	+	dcmA In	~6	
~6c	-			
~7a	+	dcmA In	~7	
~7c	-			
~8a	+	dcmA In	~8	
~8c	-			
~8b	⏏	SURGE		

827831AB-X1.CDR

Figure 3–18: TRANSDUCER INPUT/OUTPUT MODULE WIRING

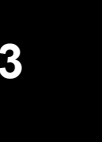

3.2.7 RS232 FACEPLATE PORT

A 9-pin RS232C serial port is located on the relay's faceplate for programming with a portable (personal) computer. All that is required to use this interface is a personal computer running the EnerVista UR Setup software provided with the relay. Cabling for the RS232 port is shown in the following figure for both 9 pin and 25 pin connectors.



The baud rate for this port is fixed at **19200 bps**.

NOTE

Front panel 9 pin RS232 Program port

- 1: N/A
- 2: (TXD)
- 3: (RXD)
- 4: N/A
- 5: (SGND) Signal Ground
- 6: N/A
- 7: N/A
- 8: N/A
- 9: N/A

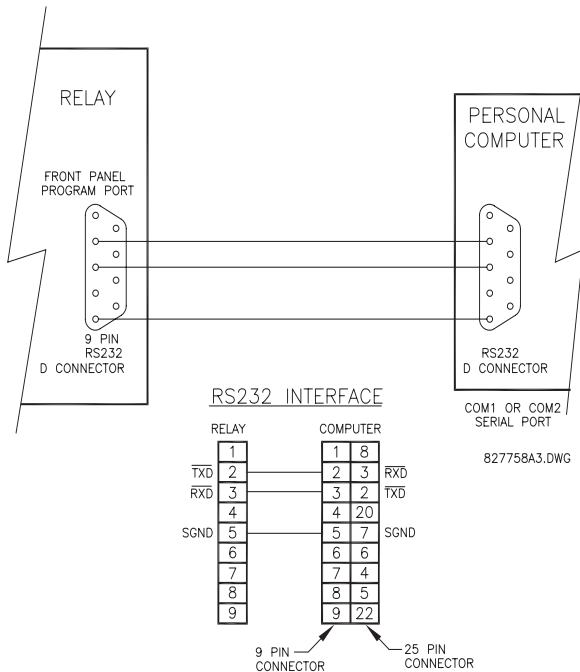

Figure 3-19: RS232 FACEPLATE PORT CONNECTION

3.2.8 CPU COMMUNICATION PORTS

a) OPTIONS

In addition to the RS232 port on the faceplate, the relay provides the user with two additional communication port(s) depending on the CPU module installed.



The CPU modules do not require a surge ground connection.

NOTE

CPU TYPE	COM1	COM2
9E	RS485	RS485
9G	10Base-F and 10Base-T	RS485
9H	Redundant 10Base-F	RS485
9J	10Base-FX	RS485
9K	Redundant 10Base-FX	RS485
9L	100Base-FX	RS485
9M	Redundant 100Base-FX	RS485
9N	10/100Base-T	RS485
9P	100Base-FX	RS485
9R	Redundant 100Base-FX	RS485

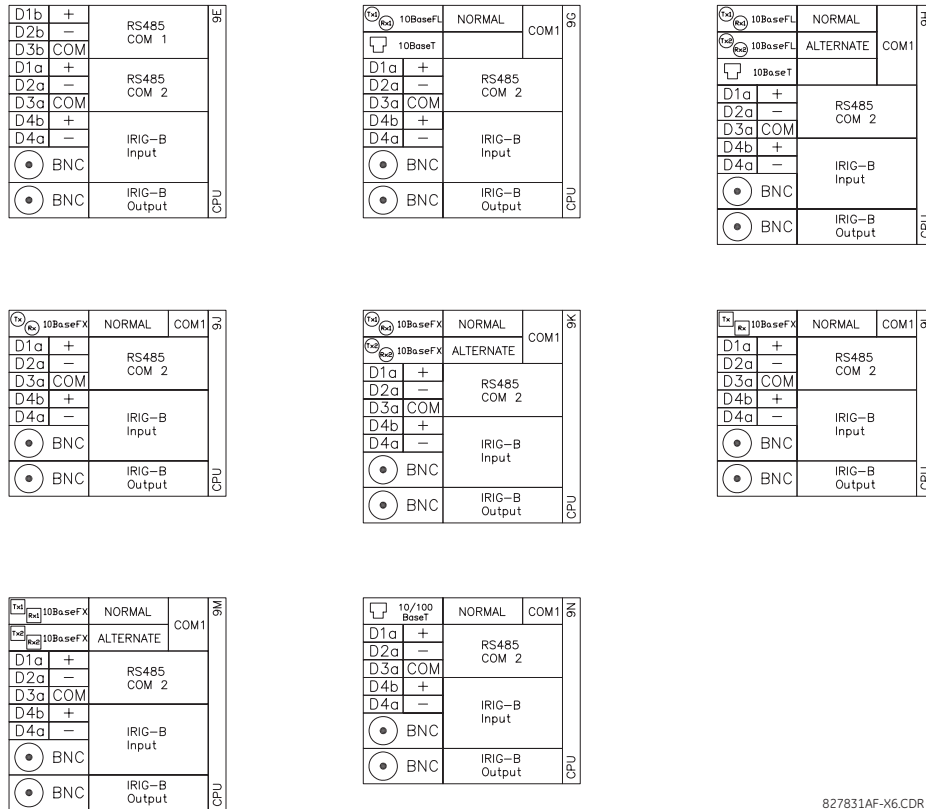

827831AF-X6.CDR

Figure 3-20: CPU MODULE COMMUNICATIONS WIRING

b) RS485 PORTS

RS485 data transmission and reception are accomplished over a single twisted pair with transmit and receive data alternating over the same two wires. Through the use of these port(s), continuous monitoring and control from a remote computer, SCADA system or PLC is possible.

To minimize errors from noise, the use of shielded twisted pair wire is recommended. Correct polarity must also be observed. For instance, the relays must be connected with all RS485 “+” terminals connected together, and all RS485 “-” terminals connected together. The COM terminal should be connected to the common wire inside the shield, when provided. To avoid loop currents, the shield should be grounded at one point only. Each relay should also be daisy chained to the next one in the link. A maximum of 32 relays can be connected in this manner without exceeding driver capability. For larger systems, additional serial channels must be added. It is also possible to use commercially available repeaters to increase the number of relays on a single channel to more than 32. Star or stub connections should be avoided entirely.

Lightning strikes and ground surge currents can cause large momentary voltage differences between remote ends of the communication link. For this reason, surge protection devices are internally provided at both communication ports. An isolated power supply with an optocoupled data interface also acts to reduce noise coupling. To ensure maximum reliability, all equipment should have similar transient protection devices installed.

Both ends of the RS485 circuit should also be terminated with an impedance as shown below.

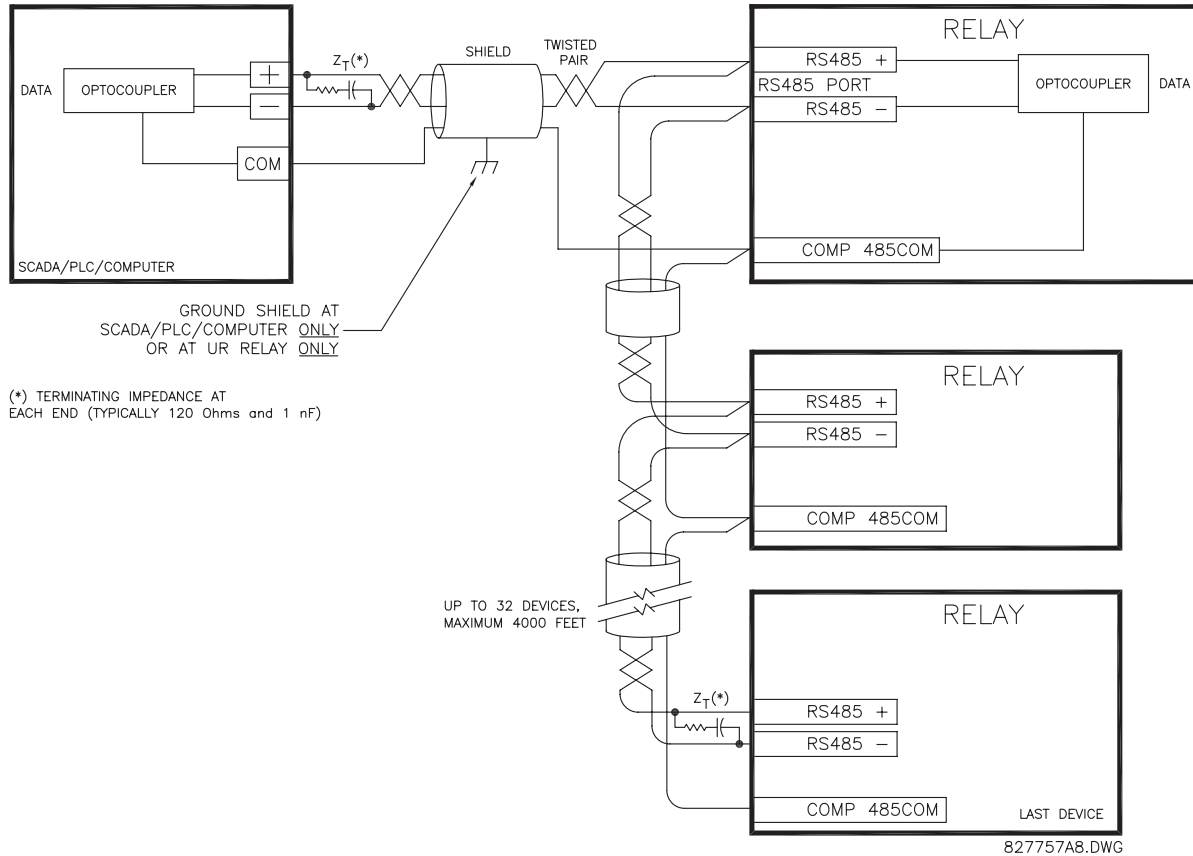

Figure 3-21: RS485 SERIAL CONNECTION

c) 10BASE-FL AND 100BASE-FX FIBER OPTIC PORTS



ENSURE THE DUST COVERS ARE INSTALLED WHEN THE FIBER IS NOT IN USE. DIRTY OR SCRATCHED CONNECTORS CAN LEAD TO HIGH LOSSES ON A FIBER LINK.



OBSERVING ANY FIBER TRANSMITTER OUTPUT MAY CAUSE INJURY TO THE EYE.

The fiber optic communication ports allow for fast and efficient communications between relays at 10 or 100Mbps. Optical fiber may be connected to the relay supporting a wavelength of 820 nm in multi-mode or 1310 nm in multi-mode and single-mode. The 10 Mbps rate is available for CPU modules 9G and 9H; 100Mbps is available for modules 9J, 9K, 9L, and 9M. The 9H, 9K and 9M modules have a second pair of identical optical fiber transmitter and receiver for redundancy.

The optical fiber sizes supported include 50/125 μm , 62.5/125 μm and 100/140 μm for 10 Mbps. The fiber optic port is designed such that the response times will not vary for any core that is 100 μm or less in diameter, 62.5 μm for 100 Mbps. For optical power budgeting, splices are required every 1 km for the transmitter/receiver pair. When splicing optical fibers, the diameter and numerical aperture of each fiber must be the same. In order to engage or disengage the ST type connector, only a quarter turn of the coupling is required.

3.2.9 IRIG-B

IRIG-B is a standard time code format that allows stamping of events to be synchronized among connected devices within 1 millisecond. The IRIG time code formats are serial, width-modulated codes which can be either DC level shifted or amplitude modulated (AM). Third party equipment is available for generating the IRIG-B signal; this equipment may use a GPS satellite system to obtain the time reference so that devices at different geographic locations can also be synchronized.

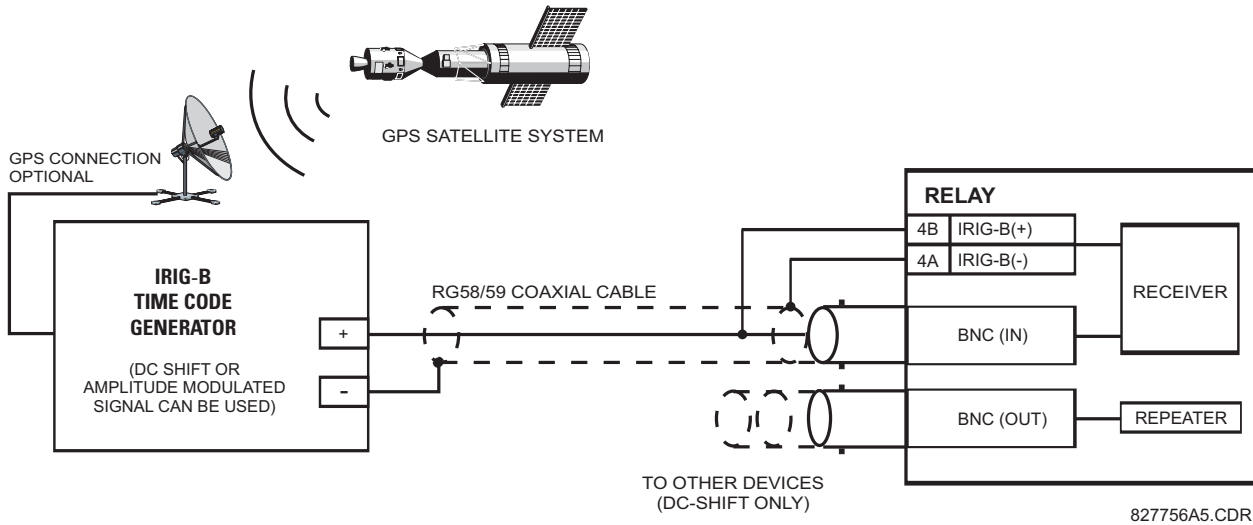

Figure 3-22: IRIG-B CONNECTION

The IRIG-B repeater provides an amplified DC-shift IRIG-B signal to other equipment. By using one IRIG-B serial connection, several UR-series relays can be synchronized. The IRIG-B repeater has a bypass function to maintain the time signal even when a relay in the series is powered down.

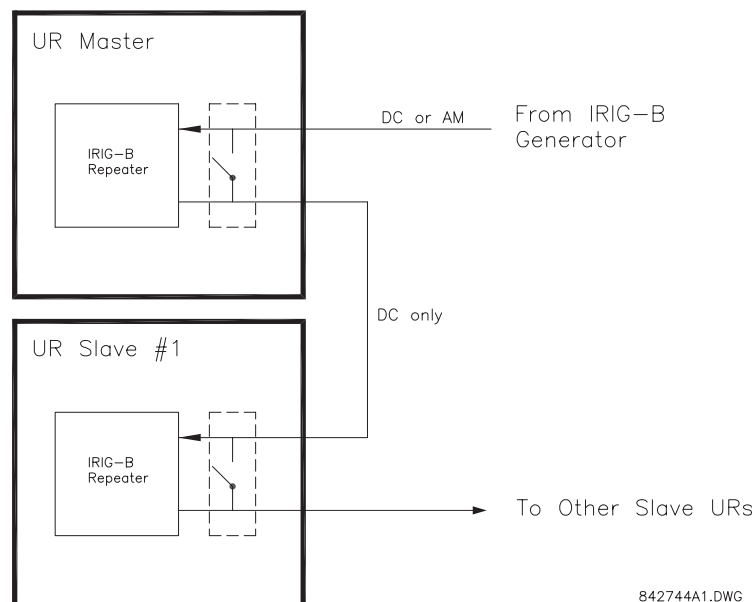

Figure 3-23: IRIG-B REPEATER

3.3.1 DESCRIPTION

The T60 direct inputs/outputs feature makes use of the Type 7 series of communications modules. These modules are also used by the L90 Line Differential Relay for inter-relay communications. The direct input/output feature uses the communications channel(s) provided by these modules to exchange digital state information between relays. This feature is available on all UR-series relay models except for the L90 Line Differential relay.

The communications channels are normally connected in a ring configuration as shown below. The transmitter of one module is connected to the receiver of the next module. The transmitter of this second module is then connected to the receiver of the next module in the ring. This is continued to form a communications ring. The figure below illustrates a ring of four UR-series relays with the following connections: UR1-Tx to UR2-Rx, UR2-Tx to UR3-Rx, UR3-Tx to UR4-Rx, and UR4-Tx to UR1-Rx. A maximum of sixteen (16) UR-series relays can be connected in a single ring

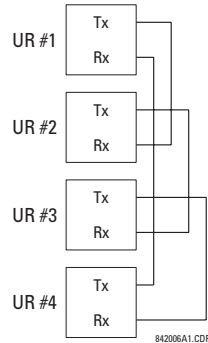

Figure 3–24: DIRECT INPUT/OUTPUT SINGLE CHANNEL CONNECTION

The interconnection for dual-channel Type 7 communications modules is shown below. Two channel modules allow for a redundant ring configuration. That is, two rings can be created to provide an additional independent data path. The required connections are: UR1-Tx1 to UR2-Rx1, UR2-Tx1 to UR3-Rx1, UR3-Tx1 to UR4-Rx1, and UR4-Tx1 to UR1-Rx1 for the first ring; and UR1-Tx2 to UR4-Rx2, UR4-Tx2 to UR3-Rx2, UR3-Tx2 to UR2-Rx2, and UR2-Tx2 to UR1-Rx2 for the second ring.

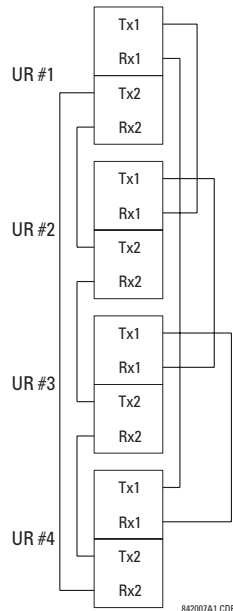

Figure 3–25: DIRECT INPUT/OUTPUT DUAL CHANNEL CONNECTION

The following diagram shows the connection for three UR-series relays using two independent communication channels. UR1 and UR3 have single Type 7 communication modules; UR2 has a dual-channel module. The two communication channels can be of different types, depending on the Type 7 modules used. To allow the direct input/output data to 'cross-over' from Channel 1 to Channel 2 on UR2, the **DIRECT I/O CHANNEL CROSSOVER** setting should be "Enabled" on UR2. This forces UR2 to forward messages received on Rx1 out Tx2, and messages received on Rx2 out Tx1.

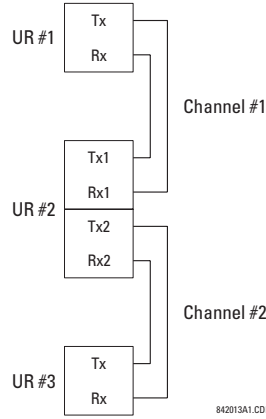

Figure 3–26: DIRECT INPUT/OUTPUT SINGLE/DUAL CHANNEL COMBINATION CONNECTION

The interconnection requirements are described in further detail in this section for each specific variation of Type 7 communications module. These modules are listed in the following table. All fiber modules use ST type connectors.

Table 3–3: CHANNEL COMMUNICATION OPTIONS

MODULE	SPECIFICATION
2A	C37.94SM, 1300 nm, single-mode, ELED, 1 channel single-mode
2B	C37.94SM, 1300 nm, single-mode, ELED, 2 channel single-mode
7A	820 nm, multi-mode, LED, 1 channel
7B	1300 nm, multi-mode, LED, 1 channel
7C	1300 nm, single-mode, ELED, 1 channel
7D	1300 nm, single-mode, LASER, 1 channel
7E	Channel 1: G.703, Channel 2: 820 nm, multi-mode
7F	Channel 1: G.703, Channel 2: 1300 nm, multi-mode
7G	Channel 1: G.703, Channel 2: 1300 nm, single-mode ELED
7H	820 nm, multi-mode, LED, 2 channels
7I	1300 nm, multi-mode, LED, 2 channels
7J	1300 nm, single-mode, ELED, 2 channels
7K	1300 nm, single-mode, LASER, 2 channels
7L	Channel 1: RS422, Channel 2: 820 nm, multi-mode, LED
7M	Channel 1: RS422, Channel 2: 1300 nm, multi-mode, LED
7N	Channel 1: RS422, Channel 2: 1300 nm, single-mode, ELED
7P	Channel 1: RS422, Channel 2: 1300 nm, single-mode, LASER
7Q	Channel 1: G.703, Channel 2: 1300 nm, single-mode, LASER
7R	G.703, 1 channel
7S	G.703, 2 channels
7T	RS422, 1 channel
7W	RS422, 2 channels
72	1550 nm, single-mode, LASER, 1 channel
73	1550 nm, single-mode, LASER, 2 channels
74	Channel 1 - RS422; Channel 2 - 1550 nm, single-mode, LASER
75	Channel 1 - G.703; Channel 2 - 1550 nm, single-mode, LASER
76	IEEE C37.94, 820 nm, multi-mode, LED, 1 channel
77	IEEE C37.94, 820 nm, multi-mode, LED, 2 channels



OBSERVING ANY FIBER TRANSMITTER OUTPUT MAY CAUSE INJURY TO THE EYE.

3.3.2 FIBER: LED AND ELED TRANSMITTERS

The following figure shows the configuration for the 7A, 7B, 7C, 7H, 7I, and 7J fiber-only modules.

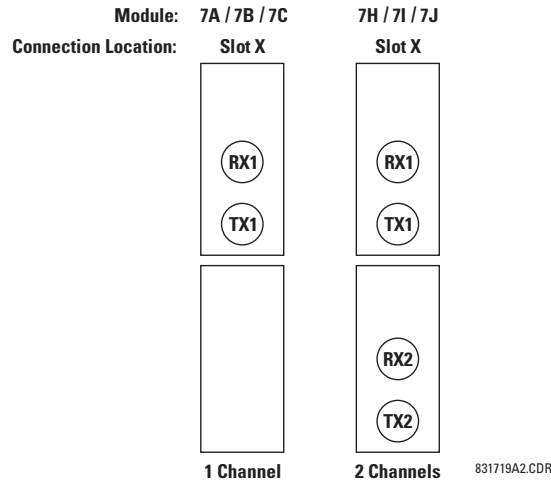

Figure 3–27: LED AND ELED FIBER MODULES

3.3.3 FIBER-LASER TRANSMITTERS

The following figure shows the configuration for the 72, 73, 7D, and 7K fiber-laser module.

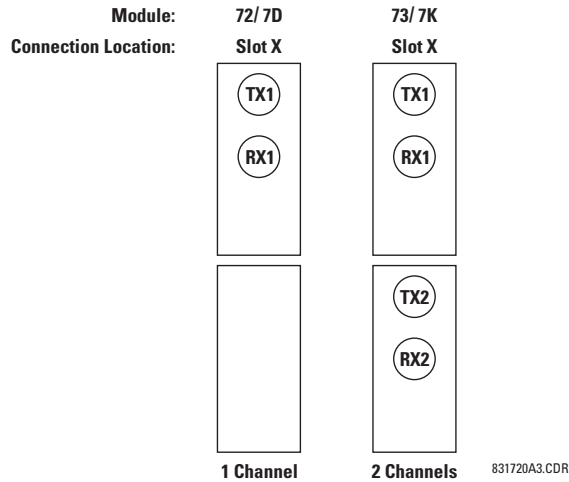

Figure 3–28: LASER FIBER MODULES



When using a LASER Interface, attenuators may be necessary to ensure that you do not exceed Maximum Optical Input Power to the receiver.

a) DESCRIPTION

The following figure shows the 64K ITU G.703 co-directional interface configuration.



The G.703 module is fixed at 64 kbps only. The SETTINGS ⇒ PRODUCT SETUP ⇒ DIRECT I/O ⇒ DIRECT I/O DATA RATE setting is not applicable to this module.

AWG 24 twisted shielded pair is recommended for external connections, with the shield grounded only at one end. Connecting the shield to Pin X1a or X6a grounds the shield since these pins are internally connected to ground. Thus, if Pin X1a or X6a is used, do not ground at the other end. This interface module is protected by surge suppression devices.

7R	G.703 CHANNEL 1	Shld.	X1a
		Tx -	X1b
		Rx -	X2a
		Tx +	X2b
		Rx +	X3a
	SURGE	⏏	X3b
	G.703 CHANNEL 2	Shld.	X6a
		Tx -	X6b
		Rx -	X7a
		Tx +	X7b
Rx +		X8a	
SURGE	⏏	X8b	
COMM.			

831727A2-X1.CDR

Figure 3–29: G.703 INTERFACE CONFIGURATION

The following figure shows the typical pin interconnection between two G.703 interfaces. For the actual physical arrangement of these pins, see the Rear Terminal Assignments section earlier in this chapter. All pin interconnections are to be maintained for a connection to a multiplexer.

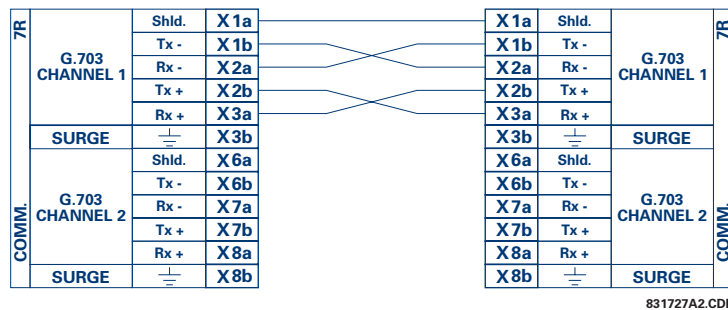

Figure 3–30: TYPICAL PIN INTERCONNECTION BETWEEN TWO G.703 INTERFACES



Pin nomenclature may differ from one manufacturer to another. Therefore, it is not uncommon to see pinouts numbered Tx_A, Tx_B, Rx_A and Rx_B. In such cases, it can be assumed that “A” is equivalent to “+” and “B” is equivalent to “-”.

b) G.703 SELECTION SWITCH PROCEDURES

1. Remove the G.703 module (7R or 7S):
The ejector/insertor clips located at the top and at the bottom of each module, must be pulled simultaneously in order to release the module for removal. Before performing this action, **control power must be removed from the relay**. The original location of the module should be recorded to help ensure that the same or replacement module is inserted into the correct slot.
2. Remove the module cover screw.
3. Remove the top cover by sliding it towards the rear and then lift it upwards.
4. Set the Timing Selection Switches (Channel 1, Channel 2) to the desired timing modes.
5. Replace the top cover and the cover screw.

6. Re-insert the G.703 module. Take care to ensure that the **correct** module type is inserted into the **correct** slot position. The ejector/insertor clips located at the top and at the bottom of each module must be in the disengaged position as the module is smoothly inserted into the slot. Once the clips have cleared the raised edge of the chassis, engage the clips simultaneously. When the clips have locked into position, the module will be fully inserted.

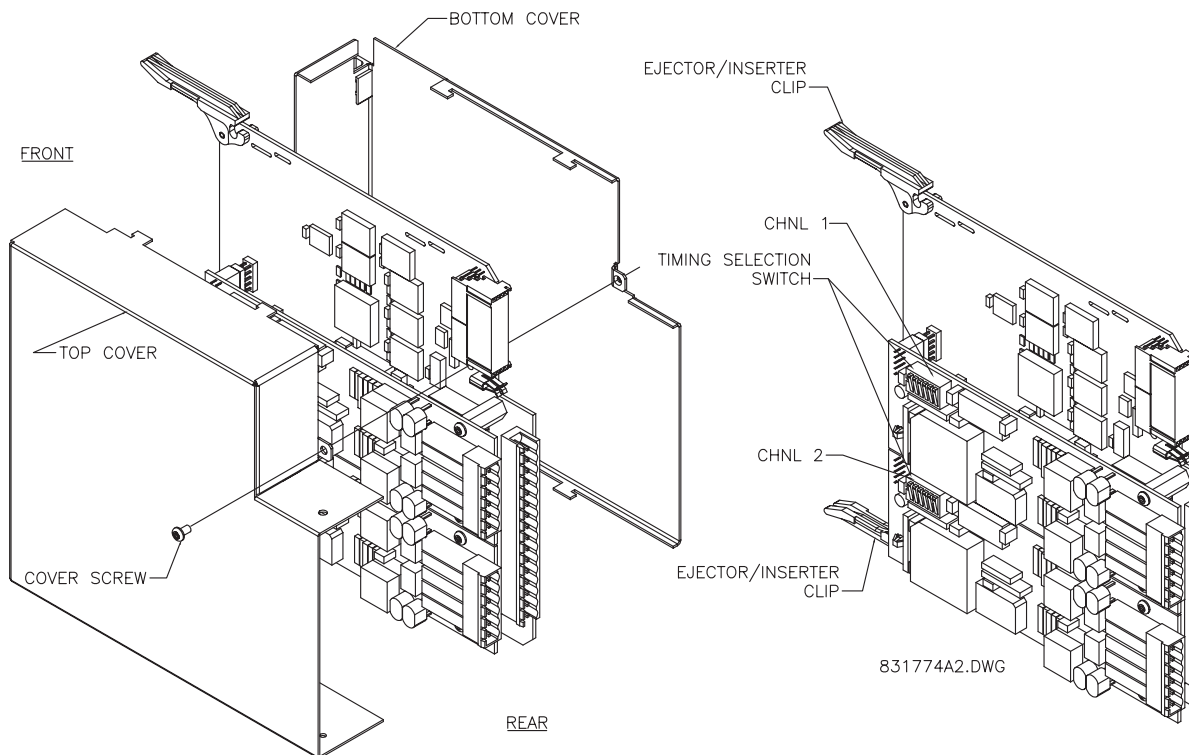

Figure 3-31: G.703 TIMING SELECTION SWITCH SETTING

Table 3-4: G.703 TIMING SELECTIONS

SWITCHES	FUNCTION
S1	OFF → Octet Timing Disabled ON → Octet Timing 8 kHz
S5 and S6	S5 = OFF and S6 = OFF → Loop Timing Mode S5 = ON and S6 = OFF → Internal Timing Mode S5 = OFF and S6 = ON → Minimum Remote Loopback Mode S5 = ON and S6 = ON → Dual Loopback Mode

c) OCTET TIMING (SWITCH S1)

If Octet Timing is enabled (ON), this 8 kHz signal will be asserted during the violation of Bit 8 (LSB) necessary for connect to higher order systems. When T60s are connected back to back, Octet Timing should be disabled (OFF).

d) TIMING MODES (SWITCHES S5 AND S6)

There are two timing modes for the G.703 module: internal timing mode and loop timing mode (default).

- **Internal Timing Mode:** The system clock is generated internally. Therefore, the G.703 timing selection should be in the Internal Timing Mode for back-to-back (UR-to-UR) connections. For back-to-back connections, set for Octet Timing (S1 = OFF) and Timing Mode = Internal Timing (S5 = ON and S6 = OFF).
- **Loop Timing Mode:** The system clock is derived from the received line signal. Therefore, the G.703 timing selection should be in Loop Timing Mode for connections to higher order systems. For connection to a higher order system (UR-to-multiplexer, factory defaults), set to Octet Timing (S1 = ON) and set Timing Mode = Loop Timing (S5 = OFF and S6 = OFF).

The switch settings for the internal and loop timing modes are shown below:

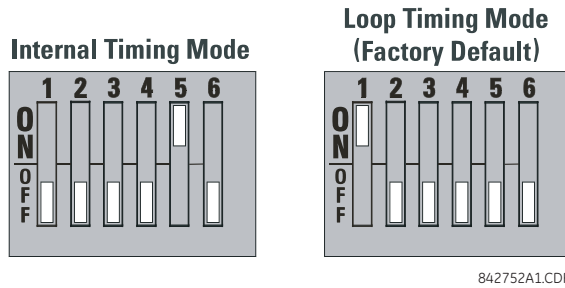

e) TEST MODES (SWITCHES S5 AND S6)

MINIMUM REMOTE LOOPBACK MODE:

In Minimum Remote Loopback mode, the multiplexer is enabled to return the data from the external interface without any processing to assist in diagnosing G.703 Line Side problems irrespective of clock rate. Data enters from the G.703 inputs, passes through the data stabilization latch which also restores the proper signal polarity, passes through the multiplexer and then returns to the transmitter. The Differential Received Data is processed and passed to the G.703 Transmitter module after which point the data is discarded. The G.703 Receiver module is fully functional and continues to process data and passes it to the Differential Manchester Transmitter module. Since timing is returned as it is received, the timing source is expected to be from the G.703 line side of the interface.

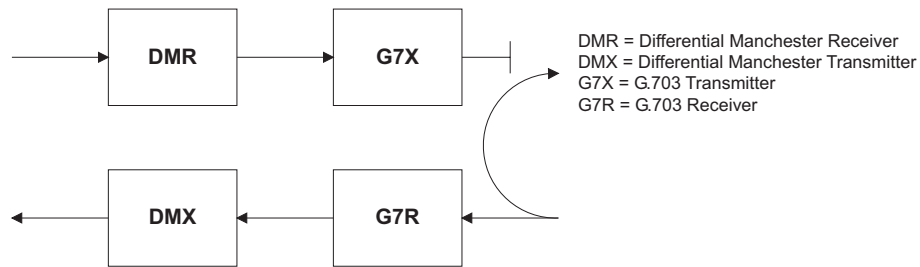

DUAL LOOPBACK MODE:

In Dual Loopback Mode, the multiplexers are active and the functions of the circuit are divided into two with each receiver/transmitter pair linked together to deconstruct and then reconstruct their respective signals. Differential Manchester data enters the Differential Manchester Receiver module and then is returned to the Differential Manchester Transmitter module. Likewise, G.703 data enters the G.703 Receiver module and is passed through to the G.703 Transmitter module to be returned as G.703 data. Because of the complete split in the communications path and because, in each case, the clocks are extracted and reconstructed with the outgoing data, in this mode there must be two independent sources of timing. One source lies on the G.703 line side of the interface while the other lies on the Differential Manchester side of the interface.

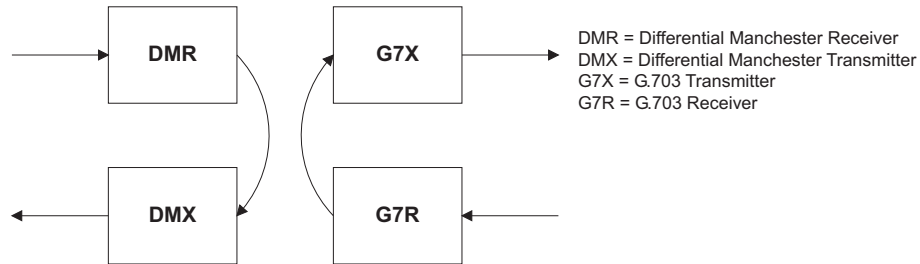

3.3.5 RS422 INTERFACE

a) DESCRIPTION

The following figure shows the RS422 2-terminal interface configuration at 64 kbps. AWG 24 twisted shielded pair is recommended for external connections. This interface module is protected by surge suppression devices which optically isolated.



The RS422 module is fixed at 64 kbps only. The SETTINGS ⇒ PRODUCT SETUP ⇒ DIRECT I/O ⇒ DIRECT I/O DATA RATE setting is not applicable to this module.

SHIELD TERMINATION

The shield pins (6a and 7b) are internally connected to the ground pin (8a). Proper shield termination is as follows:

Site 1: Terminate shield to pins 6a and/or 7b; Site 2: Terminate shield to 'COM' pin 2b.

The clock terminating impedance should match the impedance of the line.

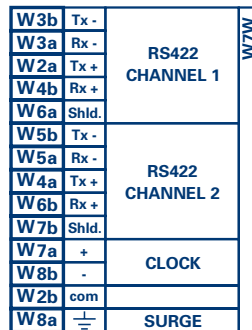

RS422.CDR
p/o 827831A6.CDR

Figure 3-32: RS422 INTERFACE CONFIGURATION

The following figure shows the typical pin interconnection between two RS422 interfaces. All pin interconnections are to be maintained for a connection to a multiplexer.

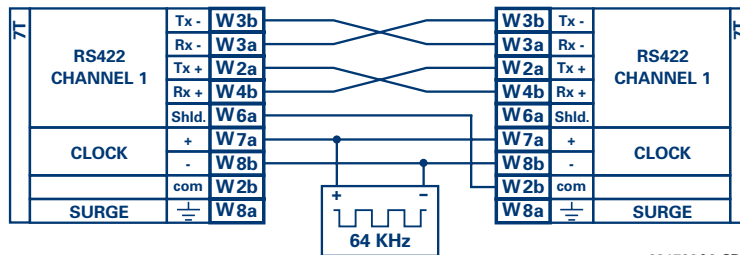

831728A3.CDR

Figure 3-33: TYPICAL PIN INTERCONNECTION BETWEEN TWO RS422 INTERFACES

b) TWO CHANNEL APPLICATIONS VIA MULTIPLEXERS

The RS422 Interface may be used for '1 channel' or '2 channel' applications over SONET/SDH and/or Multiplexed systems. When used in 1 channel applications, the RS422 interface links to higher order systems in a typical fashion observing Tx, Rx, and Send Timing connections. However, when used in 2 channel applications, certain criteria have to be followed due to the fact that there is 1 clock input for the two RS422 channels. The system will function correctly if the following connections are observed and your Data Module has a feature called Terminal Timing. Terminal Timing is a common feature to most Synchronous Data Units that allows the module to accept timing from an external source. Using the Terminal Timing feature, 2 channel applications can be achieved if these connections are followed: The Send Timing outputs from the Multiplexer - Data Module 1, will connect to the Clock inputs of the UR-RS422 interface in the usual fashion. In addition, the Send Timing outputs of Data Module 1 will also be paralleled to the Terminal Timing inputs of Data Module 2. By using this configuration the timing for both Data Modules and both UR-RS422 channels will be derived from a single clock source. As

a result, data sampling for both of the UR–RS422 channels will be synchronized via the Send Timing leads on Data Module 1 as shown in the following figure. If the Terminal Timing feature is not available or this type of connection is not desired, the G.703 interface is a viable option that does not impose timing restrictions.

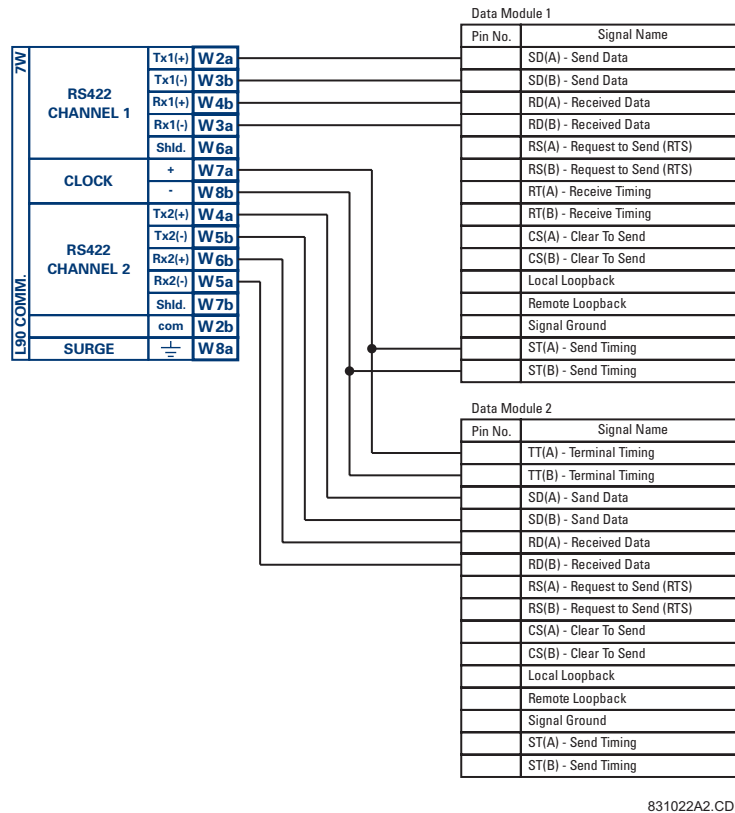

Figure 3–34: TIMING CONFIGURATION FOR RS422 TWO-CHANNEL, 3-TERMINAL APPLICATION

Data Module 1 provides timing to the T60 RS422 interface via the ST(A) and ST(B) outputs. Data Module 1 also provides timing to Data Module 2 TT(A) and TT(B) inputs via the ST(A) and AT(B) outputs. The Data Module pin numbers have been omitted in the figure above since they may vary depending on the manufacturer.

c) TRANSIT TIMING

The RS422 Interface accepts one clock input for Transmit Timing. It is important that the rising edge of the 64 kHz Transmit Timing clock of the Multiplexer Interface is sampling the data in the center of the Transmit Data window. Therefore, it is important to confirm Clock and Data Transitions to ensure Proper System Operation. For example, the following figure shows the positive edge of the Tx Clock in the center of the Tx Data bit.

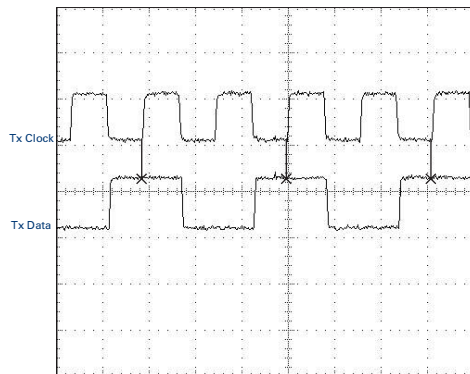

Figure 3–35: CLOCK AND DATA TRANSITIONS

d) RECEIVE TIMING

The RS422 Interface utilizes NRZI-MARK Modulation Code and; therefore, does not rely on an Rx Clock to recapture data. NRZI-MARK is an edge-type, invertible, self-clocking code.

To recover the Rx Clock from the data-stream, an integrated DPLL (Digital Phase Lock Loop) circuit is utilized. The DPLL is driven by an internal clock, which is over-sampled 16X, and uses this clock along with the data-stream to generate a data clock that can be used as the SCC (Serial Communication Controller) receive clock.

3.3.6 RS422 AND FIBER INTERFACE

The following figure shows the combined RS422 plus Fiber interface configuration at 64K baud. The 7L, 7M, 7N, 7P, and 74 modules are used in 2-terminal with a redundant channel or 3-terminal configurations where Channel 1 is employed via the RS422 interface (possibly with a multiplexer) and Channel 2 via direct fiber.

AWG 24 twisted shielded pair is recommended for external RS422 connections and the shield should be grounded only at one end. For the direct fiber channel, power budget issues should be addressed properly.



When using a LASER Interface, attenuators may be necessary to ensure that you do not exceed Maximum Optical Input Power to the receiver.

~ 1a	+	CLOCK (CHNL. 1)	~7L,M,N,P and 74
~ 1b	-		
~ 2b	com	RS422 CHNL.1	
~ 2a	Tx1+		
~ 3a	Rx1-		
~ 3b	Tx1-		
~ 4b	Rx1+		
~ 6a	Shld	FIBER CHNL.2	
(Tx2)	(Rx2)		
~ 8a	⏏	SURGE	

L907LNMPCDR
P/O 827831AE.DWG

Figure 3–36: RS422 AND FIBER INTERFACE CONNECTION

Connections shown above are for multiplexers configured as DCE (Data Communications Equipment) units.

3.3.7 G.703 AND FIBER INTERFACE

The figure below shows the combined G.703 plus Fiber interface configuration at 64K baud. The 7E, 7F, 7G, 7Q, and 75 modules are used in configurations where Channel 1 is employed via the G.703 interface (possibly with a multiplexer) and Channel 2 via direct fiber. AWG 24 twisted shielded pair is recommended for external G.703 connections connecting the shield to Pin 1A at one end only. For the direct fiber channel, power budget issues should be addressed properly. See previous sections for more details on the G.703 and Fiber interfaces.



When using a LASER Interface, attenuators may be necessary to ensure that you do not exceed Maximum Optical Input Power to the receiver.

X 1a	Shld.	G.703 CHANNEL 1	W7E, F, G and Q
X 1b	Tx -		
X 2a	Rx -		
X 2b	Tx +		
X 3a	Rx +		
X 3b	⏏	SURGE	
(Tx2)	(Rx2)	FIBER CHANNEL 2	

Figure 3–37: G.703 AND FIBER INTERFACE CONNECTION

3.3.8 IEEE C37.94 INTERFACE

The UR-series IEEE C37.94 communication modules (76 and 77) are designed to interface with IEEE C37.94 compliant digital multiplexers and/or an IEEE C37.94 compliant interface converter for use with direct input/output applications for firmware revisions 3.30 and higher. The IEEE C37.94 standard defines a point-to-point optical link for synchronous data between a multiplexer and a teleprotection device. This data is typically 64 kbps, but the standard provides for speeds up to $64n$ kbps, where $n = 1, 2, \dots, 12$. The UR-series C37.94 communication module is 64 kbps only with n fixed at 1. The frame is a valid International Telecommunications Union (ITU-T) recommended G.704 pattern from the standpoint of framing and data rate. The frame is 256 bits and is repeated at a frame rate of 8000 Hz, with a resultant bit rate of 2048 kbps.

The specifications for the module are as follows:

- IEEE standard: C37.94 for 1×64 kbps optical fiber interface
- Fiber optic cable type: 50 mm or 62.5 mm core diameter optical fiber
- Fiber optic mode: multi-mode
- Fiber optic cable length: up to 2 km
- Fiber optic connector: type ST
- Wavelength: 830 ± 40 nm
- Connection: as per all fiber optic connections, a Tx to Rx connection is required.

The UR-series C37.94 communication module can be connected directly to any compliant digital multiplexer that supports the IEEE C37.94 standard as shown below.

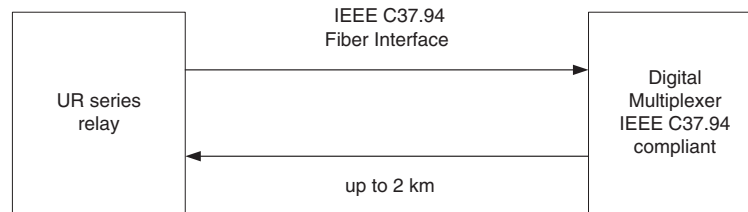

The UR-series C37.94 communication module can be connected to the electrical interface (G.703, RS422, or X.21) of a non-compliant digital multiplexer via an optical-to-electrical interface converter that supports the IEEE C37.94 standard, as shown below.

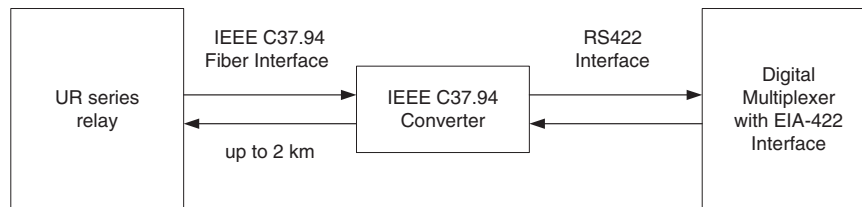

The UR-series C37.94 communication module has six (6) switches that are used to set the clock configuration. The functions of these control switches is shown below.

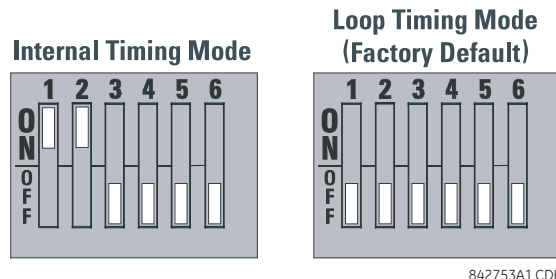

For the Internal Timing Mode, the system clock is generated internally. Therefore, the timing switch selection should be Internal Timing for Relay 1 and Loop Timed for Relay 2. There must be only one timing source configured.

For the Looped Timing Mode, the system clock is derived from the received line signal. Therefore, the timing selection should be in Loop Timing Mode for connections to higher order systems.

The C37.94 communications module cover removal procedure is as follows:

1. Remove the C37.94 module (76 or 77):

The ejector/inserter clips located at the top and at the bottom of each module, must be pulled simultaneously in order to release the module for removal. Before performing this action, **control power must be removed from the relay**. The original location of the module should be recorded to help ensure that the same or replacement module is inserted into the correct slot.

2. Remove the module cover screw.
3. Remove the top cover by sliding it towards the rear and then lift it upwards.
4. Set the Timing Selection Switches (Channel 1, Channel 2) to the desired timing modes (see description above).
5. Replace the top cover and the cover screw.
6. Re-insert the C37.94 module Take care to ensure that the **correct** module type is inserted into the **correct** slot position. The ejector/inserter clips located at the top and at the bottom of each module must be in the disengaged position as the module is smoothly inserted into the slot. Once the clips have cleared the raised edge of the chassis, engage the clips simultaneously. When the clips have locked into position, the module will be fully inserted.

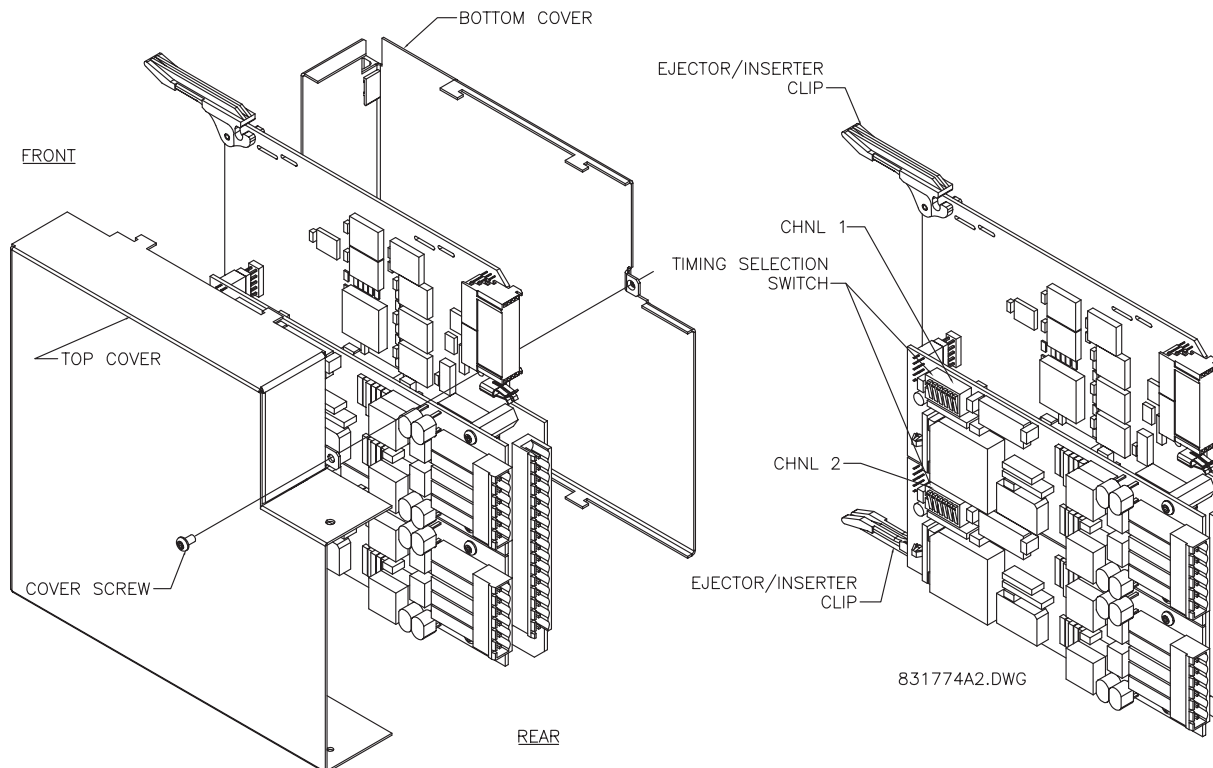

Figure 3–38: IEEE C37.94 TIMING SELECTION SWITCH SETTING

3.3.9 C37.94SM INTERFACE

The UR-series C37.94SM communication modules (2A and 2B) are designed to interface with modified IEEE C37.94 compliant digital multiplexers and/or IEEE C37.94 compliant interface converters that have been converted from 820 nm multi-mode fiber optics to 1300 nm ELED single-mode fiber optics. The IEEE C37.94 standard defines a point-to-point optical link for synchronous data between a multiplexer and a teleprotection device. This data is typically 64 kbps, but the standard provides for speeds up to $64n$ kbps, where $n = 1, 2, \dots, 12$. The UR-series C37.94SM communication module is 64 kbps only with n fixed at 1. The frame is a valid International Telecommunications Union (ITU-T) recommended G.704 pattern from the standpoint of framing and data rate. The frame is 256 bits and is repeated at a frame rate of 8000 Hz, with a resultant bit rate of 2048 kbps.

The specifications for the module are as follows:

- Emulated IEEE standard: emulates C37.94 for 1×64 kbps optical fiber interface (modules set to $n = 1$ or 64 kbps)
- Fiber optic cable type: 9/125 μm core diameter optical fiber
- Fiber optic mode: single-mode, ELED compatible with HP HFBR-1315T transmitter and HP HFBR-2316T receiver
- Fiber optic cable length: up to 10 km
- Fiber optic connector: type ST
- Wavelength: 1300 ± 40 nm
- Connection: as per all fiber optic connections, a Tx to Rx connection is required.

The UR-series C37.94SM communication module can be connected **directly** to any compliant digital multiplexer that supports C37.94SM as shown below.

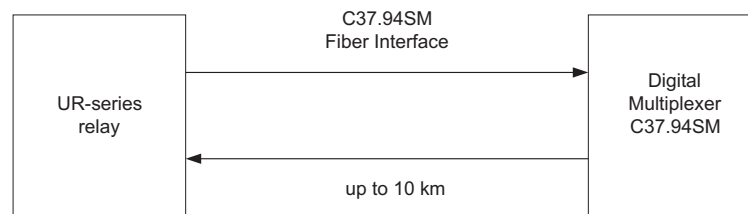

It can also be connected **directly** to any other UR-series relay with a C37.94SM module as shown below.

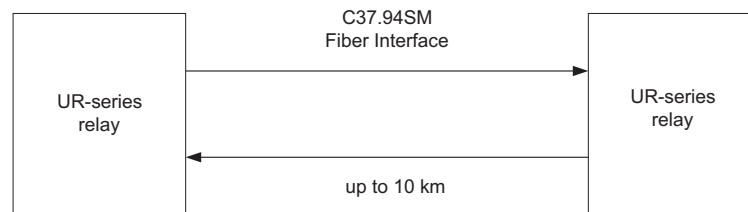

The UR-series C37.94SM communication module has six (6) switches that are used to set the clock configuration. The functions of these control switches is shown below.

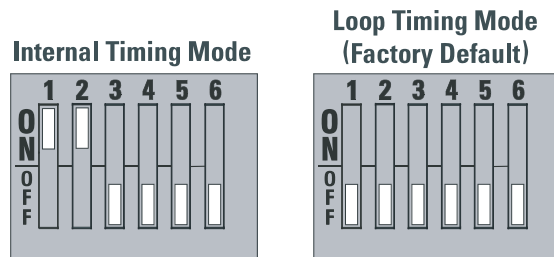

842753A1.CDR

For the Internal Timing Mode, the system clock is generated internally. Therefore, the timing switch selection should be Internal Timing for Relay 1 and Loop Timed for Relay 2. There must be only one timing source configured.

For the Looped Timing Mode, the system clock is derived from the received line signal. Therefore, the timing selection should be in Loop Timing Mode for connections to higher order systems.

The C37.94SM communications module cover removal procedure is as follows:

1. Remove the C37.94SM module (modules 2A or 2B):

The ejector/inserter clips located at the top and at the bottom of each module, must be pulled simultaneously in order to release the module for removal. Before performing this action, **control power must be removed from the relay**. The original location of the module should be recorded to help ensure that the same or replacement module is inserted into the correct slot.

2. Remove the module cover screw.
3. Remove the top cover by sliding it towards the rear and then lift it upwards.
4. Set the Timing Selection Switches (Channel 1, Channel 2) to the desired timing modes (see description above).
5. Replace the top cover and the cover screw.
6. Re-insert the C37.94SM module. Take care to ensure that the **correct** module type is inserted into the **correct** slot position. The ejector/inserter clips located at the top and at the bottom of each module must be in the disengaged position as the module is smoothly inserted into the slot. Once the clips have cleared the raised edge of the chassis, engage the clips simultaneously. When the clips have locked into position, the module will be fully inserted.

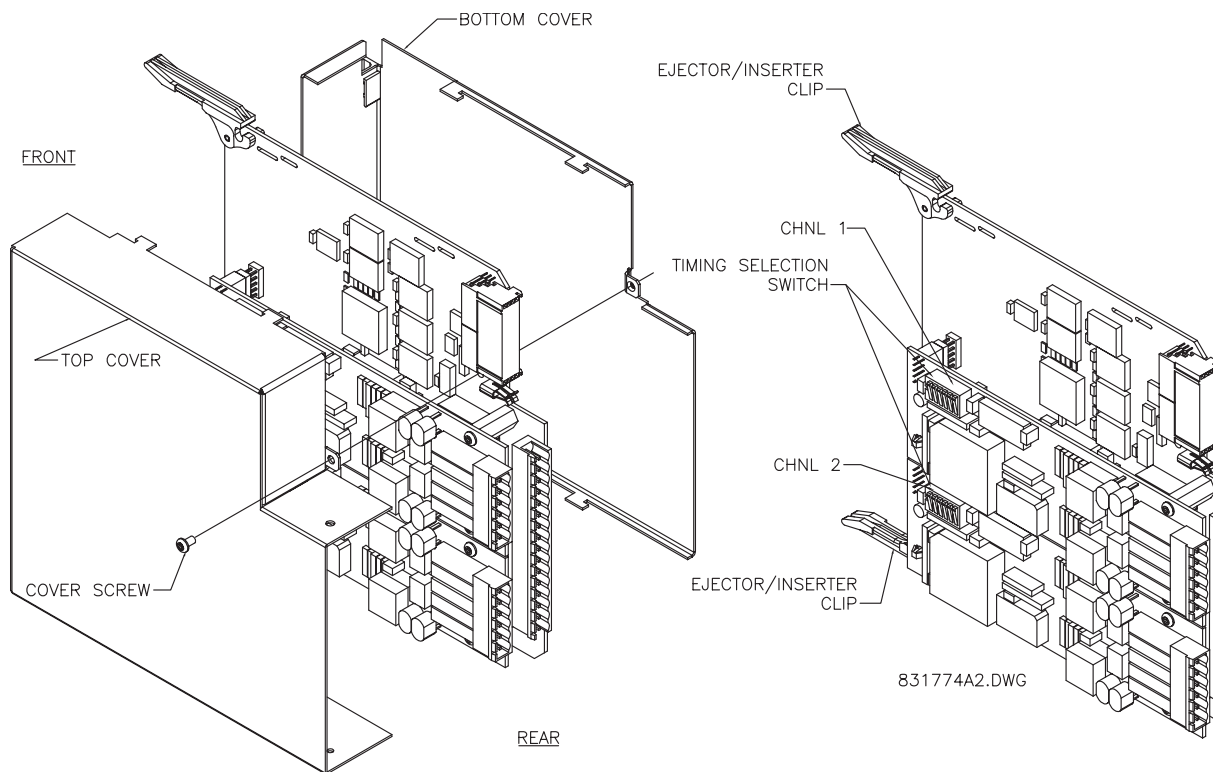

Figure 3-39: C37.94SM TIMING SELECTION SWITCH SETTING

4.1.1 INTRODUCTION

The EnerVista UR Setup software provides a graphical user interface (GUI) as one of two human interfaces to a UR device. The alternate human interface is implemented via the device's faceplate keypad and display (see Faceplate Interface section in this chapter).

The EnerVista UR Setup software provides a single facility to configure, monitor, maintain, and trouble-shoot the operation of relay functions, connected over local or wide area communication networks. It can be used while disconnected (i.e. off-line) or connected (i.e. on-line) to a UR device. In off-line mode, settings files can be created for eventual downloading to the device. In on-line mode, you can communicate with the device in real-time.

The EnerVista UR Setup software, provided with every T60 relay, can be run from any computer supporting Microsoft Windows® 95, 98, NT, 2000, ME, and XP. This chapter provides a summary of the basic EnerVista UR Setup software interface features. The EnerVista UR Setup Help File provides details for getting started and using the EnerVista UR Setup software interface.

4.1.2 CREATING A SITE LIST

To start using the EnerVista UR Setup software, a site definition and device definition must first be created. See the EnerVista UR Setup Help File or refer to the *Connecting EnerVista UR Setup with the T60* section in Chapter 1 for details.

4.1.3 SOFTWARE OVERVIEW**a) ENGAGING A DEVICE**

The EnerVista UR Setup software may be used in on-line mode (relay connected) to directly communicate with a UR relay. Communicating relays are organized and grouped by communication interfaces and into sites. Sites may contain any number of relays selected from the UR product series.

b) USING SETTINGS FILES

The EnerVista UR Setup software interface supports three ways of handling changes to relay settings:

- In off-line mode (relay disconnected) to create or edit relay settings files for later download to communicating relays.
- While connected to a communicating relay to directly modify any relay settings via relay data view windows, and then save the settings to the relay.
- You can create/edit settings files and then write them to the relay while the interface is connected to the relay.

Settings files are organized on the basis of file names assigned by the user. A settings file contains data pertaining to the following types of relay settings:

- Device Definition
- Product Setup
- System Setup
- FlexLogic™
- Grouped Elements
- Control Elements
- Inputs/Outputs
- Testing

Factory default values are supplied and can be restored after any changes.

c) CREATING AND EDITING FLEXLOGIC™

You can create or edit a FlexLogic™ equation in order to customize the relay. You can subsequently view the automatically generated logic diagram.

d) VIEWING ACTUAL VALUES

You can view real-time relay data such as input/output status and measured parameters.

e) VIEWING TRIGGERED EVENTS

While the interface is in either on-line or off-line mode, you can view and analyze data generated by triggered specified parameters, via one of the following:

- **Event Recorder facility:** The event recorder captures contextual data associated with the last 1024 events, listed in chronological order from most recent to oldest.
- **Oscillography facility:** The oscillography waveform traces and digital states are used to provide a visual display of power system and relay operation data captured during specific triggered events.

f) FILE SUPPORT

- **Execution:** Any EnerVista UR Setup file which is double clicked or opened will launch the application, or provide focus to the already opened application. If the file was a settings file (has a `URS` extension) which had been removed from the Settings List tree menu, it will be added back to the Settings List tree menu.
- **Drag and Drop:** The Site List and Settings List control bar windows are each mutually a drag source and a drop target for device-order-code-compatible files or individual menu items. Also, the Settings List control bar window and any Windows Explorer directory folder are each mutually a file drag source and drop target.

New files which are dropped into the Settings List window are added to the tree which is automatically sorted alphabetically with respect to settings file names. Files or individual menu items which are dropped in the selected device menu in the Site List window will automatically be sent to the on-line communicating device.

g) FIRMWARE UPGRADES

The firmware of a T60 device can be upgraded, locally or remotely, via the EnerVista UR Setup software. The corresponding instructions are provided by the EnerVista UR Setup Help file under the topic “Upgrading Firmware”.



Modbus addresses assigned to firmware modules, features, settings, and corresponding data items (i.e. default values, minimum/maximum values, data type, and item size) may change slightly from version to version of firmware. The addresses are rearranged when new features are added or existing features are enhanced or modified. The **EEPROM DATA ERROR** message displayed after upgrading/downgrading the firmware is a resettable, self-test message intended to inform users that the Modbus addresses have changed with the upgraded firmware. This message does not signal any problems when appearing after firmware upgrades.

4.1.4 ENERVISTA UR SETUP MAIN WINDOW

The EnerVista UR Setup software main window supports the following primary display components:

- Title bar which shows the pathname of the active data view
- Main window menu bar
- Main window tool bar
- Site List control bar window
- Settings List control bar window
- Device data view window(s), with common tool bar
- Settings File data view window(s), with common tool bar
- Workspace area with data view tabs
- Status bar

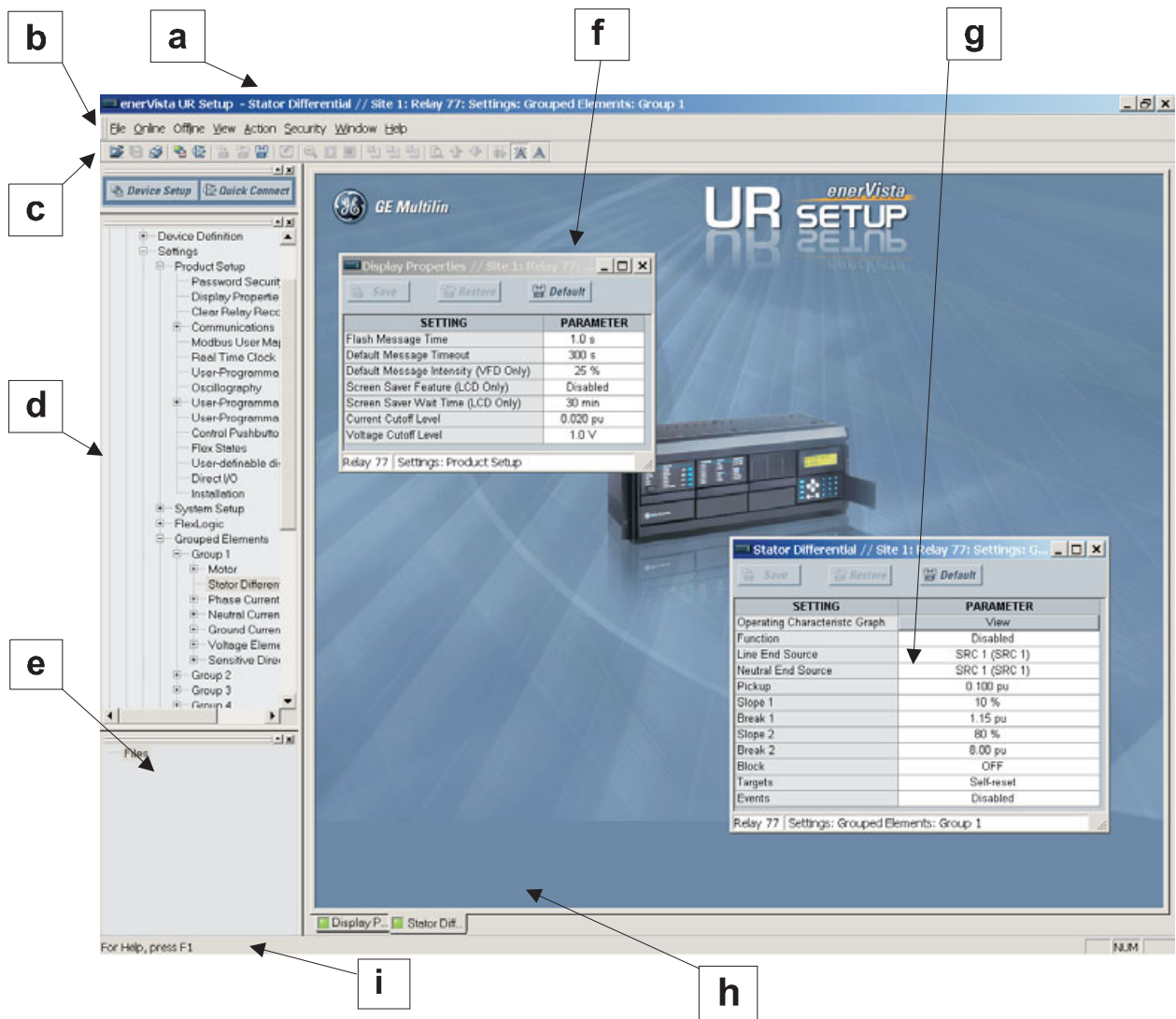

Figure 4–1: ENERVISTA UR SETUP SOFTWARE MAIN WINDOW

4.2.1 FACEPLATE

The keypad/display/LED interface is one of two alternate human interfaces supported. The other alternate human interface is implemented via the EnerVista UR Setup software. The faceplate interface is available in two configurations: horizontal or vertical. The faceplate interface consists of several functional panels.

The faceplate is hinged to allow easy access to the removable modules. There is also a removable dust cover that fits over the faceplate which must be removed in order to access the keypad panel. The following two figures show the horizontal and vertical arrangement of faceplate panels.

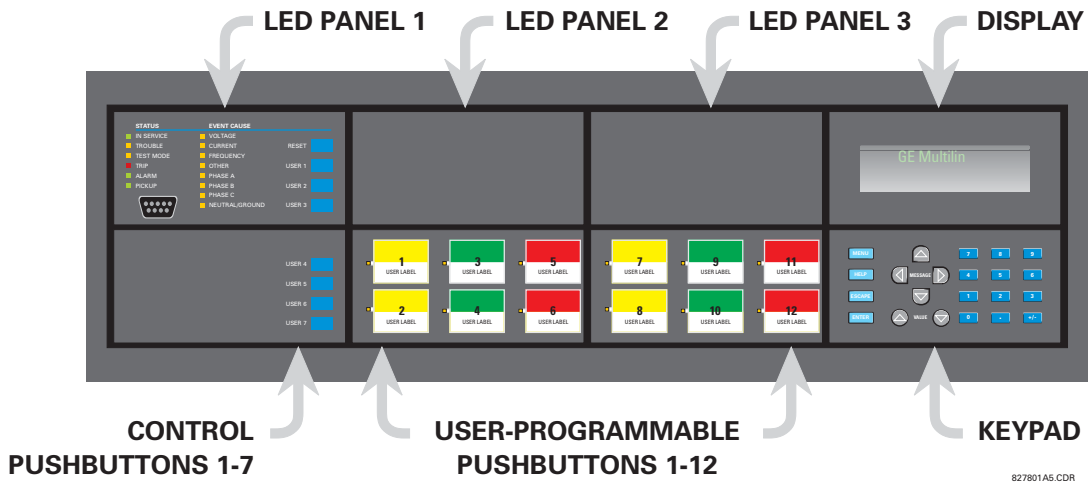

Figure 4-2: UR-SERIES HORIZONTAL FACEPLATE PANELS

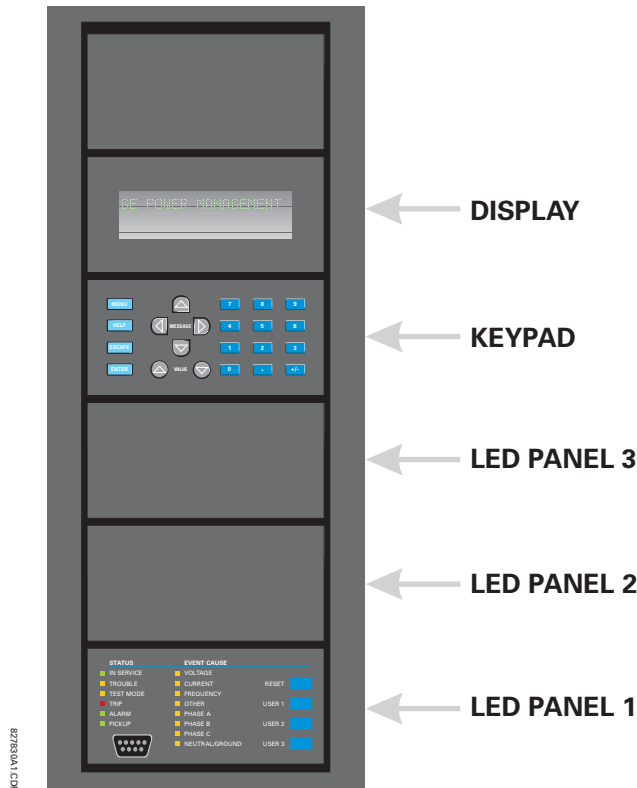

Figure 4-3: UR-SERIES VERTICAL FACEPLATE PANELS

4.2.2 LED INDICATORS

a) LED PANEL 1

This panel provides several LED indicators, several keys, and a communications port. The RESET key is used to reset any latched LED indicator or target message, once the condition has been cleared (these latched conditions can also be reset via the **SETTINGS** ⇒ **INPUT/OUTPUTS** ⇒ **RESETTING** menu). The USER keys are not used in this unit. The RS232 port is intended for connection to a portable PC.

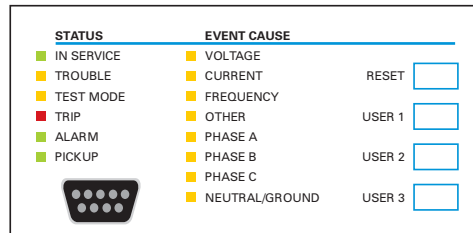

Figure 4-4: LED PANEL 1

STATUS INDICATORS:

- **IN SERVICE:** Indicates that control power is applied; all monitored inputs/outputs and internal systems are OK; the relay has been programmed.
- **TROUBLE:** Indicates that the relay has detected an internal problem.
- **TEST MODE:** Indicates that the relay is in test mode.
- **TRIP:** Indicates that the selected FlexLogic™ operand serving as a Trip switch has operated. This indicator always latches; the RESET command must be initiated to allow the latch to be reset.
- **ALARM:** Indicates that the selected FlexLogic™ operand serving as an Alarm switch has operated. This indicator is never latched.
- **PICKUP:** Indicates that an element is picked up. This indicator is never latched.

EVENT CAUSE INDICATORS:

These indicate the input type that was involved in a condition detected by an element that is operated or has a latched flag waiting to be reset.

- **VOLTAGE:** Indicates voltage was involved.
- **CURRENT:** Indicates current was involved.
- **FREQUENCY:** Indicates frequency was involved.
- **OTHER:** Indicates a composite function was involved.
- **PHASE A:** Indicates Phase A was involved.
- **PHASE B:** Indicates Phase B was involved.
- **PHASE C:** Indicates Phase C was involved.
- **NEUTRAL/GROUND:** Indicates neutral or ground was involved.

b) LED PANELS 2 AND 3

These panels provide 48 amber LED indicators whose operation is controlled by the user. Support for applying a customized label beside every LED is provided.

User customization of LED operation is of maximum benefit in installations where languages other than English are used to communicate with operators. Refer to the *User-Programmable LEDs* section in Chapter 5 for the settings used to program the operation of the LEDs on these panels.

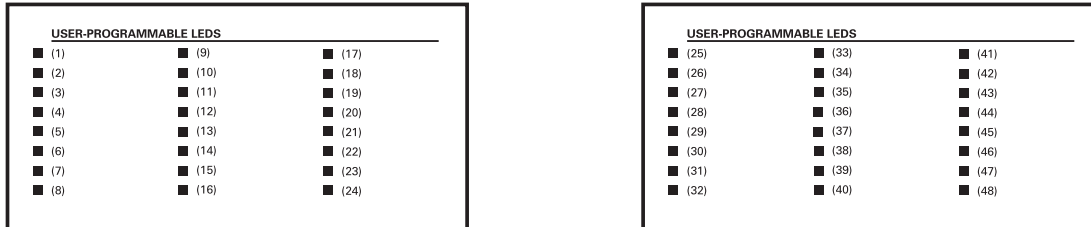

Figure 4-5: LED PANELS 2 AND 3 (INDEX TEMPLATE)

c) DEFAULT LABELS FOR LED PANEL 2

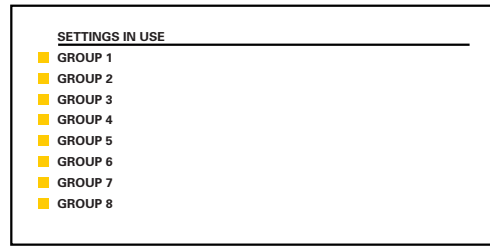

Figure 4-6: LED PANEL 2 (DEFAULT LABEL)

The default labels represent the following:

- **GROUP 1...6:** The illuminated GROUP is the active settings group.



Firmware revisions 2.9x and earlier support eight user setting groups; revisions 3.0x and higher support six setting groups. For convenience of users using earlier firmware revisions, the relay panel shows eight setting groups. Please note that the LEDs, despite their default labels, are fully user-programmable.

d) CUSTOM LABELING OF LEDS

Custom labeling of an LED-only panel is facilitated through a Microsoft Word file available from the following URL:

<http://www.GEindustrial.com/multilin/support/ur/>

This file provides templates and instructions for creating appropriate labeling for the LED panel. The following procedures are contained in the downloadable file. The panel templates provide relative LED locations and located example text (x) edit boxes. The following procedure demonstrates how to install/uninstall the custom panel labeling.

1. Remove the clear Lexan Front Cover (GE Multilin Part Number: 1501-0014).



2. Pop out the LED Module and/or the Blank Module with a screwdriver as shown below. Be careful not to damage the plastic.

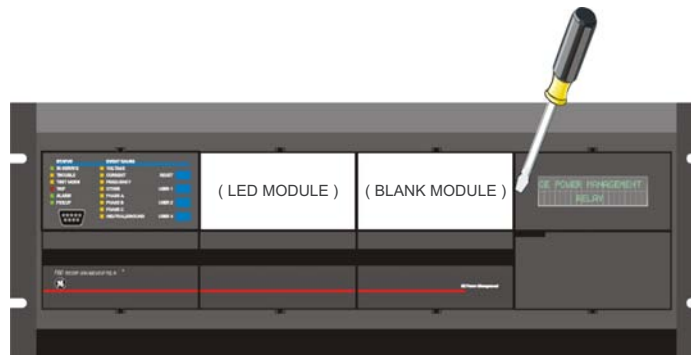

3. Place the left side of the customized module back to the front panel frame, then snap back the right side.
4. Put the clear Lexan Front Cover back into place.

e) CUSTOMIZING THE DISPLAY MODULE

The following items are required to customize the T60 display module:

- Black and white or color printer (color preferred).
 - Microsoft Word 97 or later software for editing the template.
 - 1 each of: 8.5" x 11" white paper, exacto knife, ruler, custom display module (GE Multilin Part Number: 1516-0069), and a custom module cover (GE Multilin Part Number: 1502-0015).
1. Open the LED panel customization template with Microsoft Word. Add text in places of the **LED x** text placeholders on the template(s). Delete unused place holders as required.
 2. When complete, save the Word file to your local PC for future use.
 3. Print the template(s) to a local printer.
 4. From the printout, cut-out the Background Template from the three windows, using the cropmarks as a guide.
 5. Put the Background Template on top of the custom display module (GE Multilin Part Number: 1513-0069) and snap the clear custom module cover (GE Multilin Part Number: 1502-0015) over it and the templates.

4.2.3 DISPLAY

All messages are displayed on a 2 × 20 character vacuum fluorescent display to make them visible under poor lighting conditions. An optional liquid crystal display (LCD) is also available. Messages are displayed in English and do not require the aid of an instruction manual for deciphering. While the keypad and display are not actively being used, the display will default to defined messages. Any high priority event driven message will automatically override the default message and appear on the display.

4.2.4 KEYPAD

Display messages are organized into ‘pages’ under the following headings: Actual Values, Settings, Commands, and Targets. The **MENU** key navigates through these pages. Each heading page is broken down further into logical subgroups.

The **▲** **◀** MESSAGE **▶** **▼** keys navigate through the subgroups. The **▲** VALUE **▼** keys scroll increment or decrement numerical setting values when in programming mode. These keys also scroll through alphanumeric values in the text edit mode. Alternatively, values may also be entered with the numeric keypad.

The **▶** key initiates and advance to the next character in text edit mode or enters a decimal point. The **HELP** key may be pressed at any time for context sensitive help messages. The **ENTER** key stores altered setting values.

4.2.5 MENUS

a) NAVIGATION

Press the **MENU** key to select the desired header display page (top-level menu). The header title appears momentarily followed by a header display page menu item. Each press of the **MENU** key advances through the main heading pages as illustrated below.

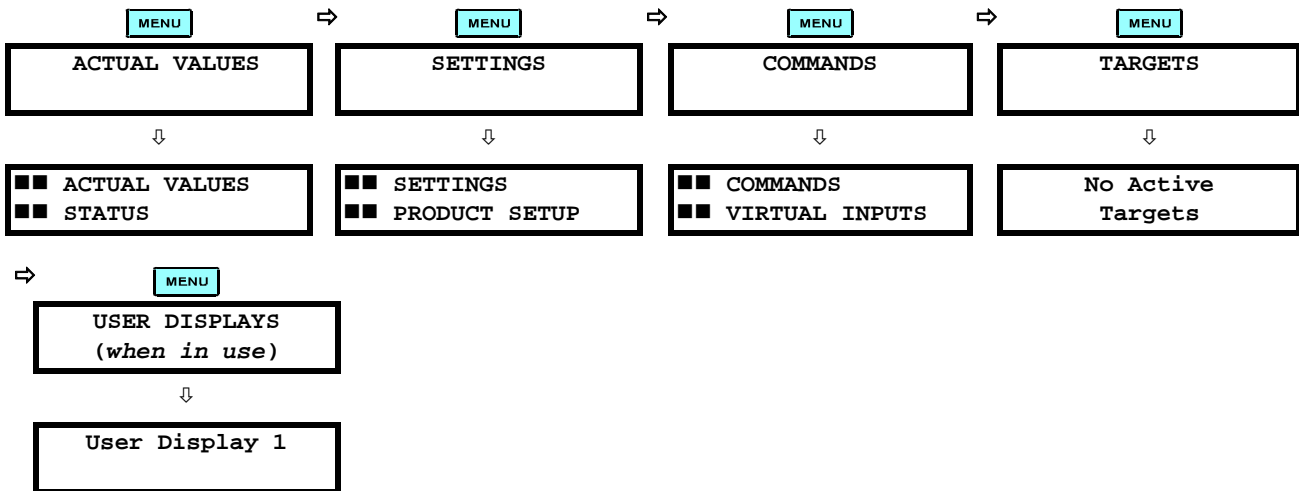

b) HIERARCHY

The setting and actual value messages are arranged hierarchically. The header display pages are indicated by double scroll bar characters (■■), while sub-header pages are indicated by single scroll bar characters (■). The header display pages represent the highest level of the hierarchy and the sub-header display pages fall below this level. The MESSAGE ▲ and ▼ keys move within a group of headers, sub-headers, setting values, or actual values. Continually pressing the MESSAGE ► key from a header display displays specific information for the header category. Conversely, continually pressing the ◀ MESSAGE key from a setting value or actual value display returns to the header display.

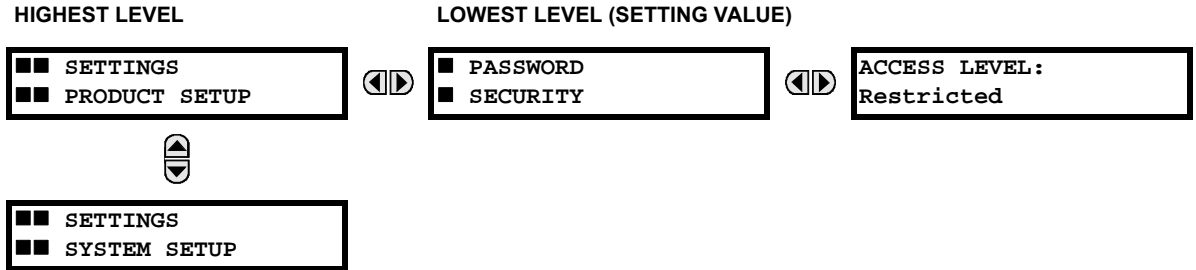

c) EXAMPLE NAVIGATION SCENARIO

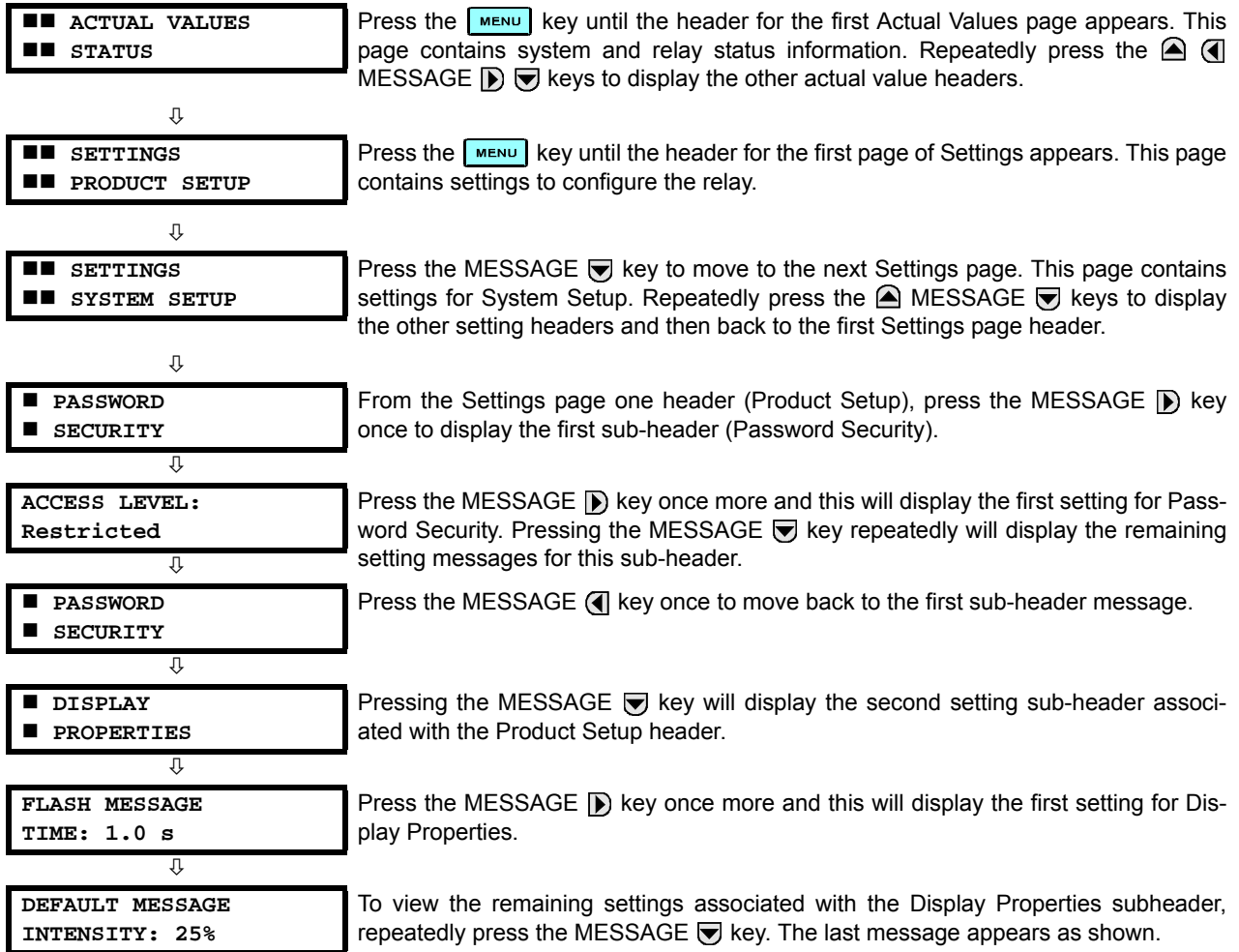

4.2.6 CHANGING SETTINGS

a) ENTERING NUMERICAL DATA

Each numerical setting has its own minimum, maximum, and increment value associated with it. These parameters define what values are acceptable for a setting.

FLASH MESSAGE
TIME: 1.0 s

For example, select the **SETTINGS** ⇒ **PRODUCT SETUP** ⇒ **DISPLAY PROPERTIES** ⇒ **FLASH MESSAGE TIME** setting.



MINIMUM: 0.5
MAXIMUM: 10.0

Press the **HELP** key to view the minimum and maximum values. Press the **HELP** key again to view the next context sensitive help message.

Two methods of editing and storing a numerical setting value are available.

- **0 to 9** and **.** (decimal point): The relay numeric keypad works the same as that of any electronic calculator. A number is entered one digit at a time. The leftmost digit is entered first and the rightmost digit is entered last. Pressing the MESSAGE **↩** key or pressing the ESCAPE key, returns the original value to the display.
- **▲ VALUE ▼**: The VALUE **▲** key increments the displayed value by the step value, up to the maximum value allowed. While at the maximum value, pressing the VALUE **▲** key again will allow the setting selection to continue upward from the minimum value. The VALUE **▼** key decrements the displayed value by the step value, down to the minimum value. While at the minimum value, pressing the VALUE **▼** key again will allow the setting selection to continue downward from the maximum value.

FLASH MESSAGE
TIME: 2.5 s

As an example, set the flash message time setting to 2.5 seconds. Press the appropriate numeric keys in the sequence "2 . 5". The display message will change as the digits are being entered.



NEW SETTING
HAS BEEN STORED

Until **ENTER** is pressed, editing changes are not registered by the relay. Therefore, press **ENTER** to store the new value in memory. This flash message will momentarily appear as confirmation of the storing process. Numerical values which contain decimal places will be rounded-off if more decimal place digits are entered than specified by the step value.

b) ENTERING ENUMERATION DATA

Enumeration settings have data values which are part of a set, whose members are explicitly defined by a name. A set is comprised of two or more members.

ACCESS LEVEL:
Restricted

For example, the selections available for **ACCESS LEVEL** are "Restricted", "Command", "Setting", and "Factory Service".

Enumeration type values are changed using the VALUE keys. The VALUE **▲** key displays the next selection while the VALUE **▼** key displays the previous selection.

ACCESS LEVEL:
Setting

If the **ACCESS LEVEL** needs to be "Setting", press the VALUE keys until the proper selection is displayed. Press **HELP** at any time for the context sensitive help messages.



NEW SETTING
HAS BEEN STORED

Changes are not registered by the relay until the **ENTER** key is pressed. Pressing **ENTER** stores the new value in memory. This flash message momentarily appears as confirmation of the storing process.

c) ENTERING ALPHANUMERIC TEXT

Text settings have data values which are fixed in length, but user-defined in character. They may be comprised of upper case letters, lower case letters, numerals, and a selection of special characters.

There are several places where text messages may be programmed to allow the relay to be customized for specific applications. One example is the Message Scratchpad. Use the following procedure to enter alphanumeric text messages.

For example: to enter the text, "Breaker #1"

1. Press **•** to enter text edit mode.
2. Press the VALUE keys until the character 'B' appears; press **•** to advance the cursor to the next position.
3. Repeat step 2 for the remaining characters: r,e,a,k,e,r, ,#,1.
4. Press **ENTER** to store the text.
5. If you have any problem, press **HELP** to view context sensitive help. Flash messages will sequentially appear for several seconds each. For the case of a text setting message, pressing **HELP** displays how to edit and store new values.

d) ACTIVATING THE RELAY

**RELAY SETTINGS:
Not Programmed**

When the relay is powered up, the Trouble LED will be on, the In Service LED off, and this message displayed, indicating the relay is in the "Not Programmed" state and is safeguarding (output relays blocked) against the installation of a relay whose settings have not been entered. This message remains until the relay is explicitly put in the "Programmed" state.

To change the RELAY SETTINGS: "Not Programmed" mode to "Programmed", proceed as follows:

1. Press the **MENU** key until the **SETTINGS** header flashes momentarily and the **SETTINGS PRODUCT SETUP** message appears on the display.
2. Press the MESSAGE **▶** key until the **PASSWORD SECURITY** message appears on the display.
3. Press the MESSAGE **▼** key until the **INSTALLATION** message appears on the display.
4. Press the MESSAGE **▶** key until the **RELAY SETTINGS: Not Programmed** message is displayed.

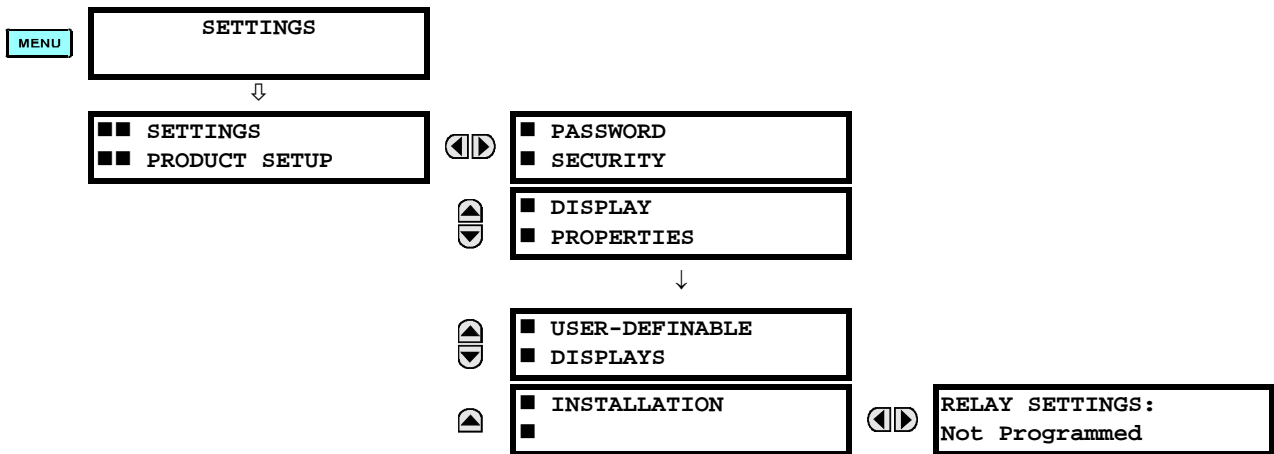

5. After the **RELAY SETTINGS: Not Programmed** message appears on the display, press the VALUE keys change the selection to "Programmed".
6. Press the **ENTER** key.

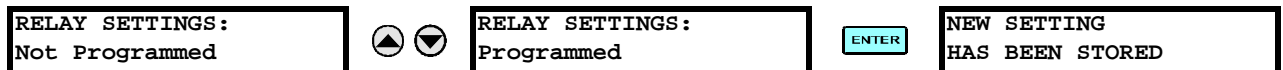

7. When the "NEW SETTING HAS BEEN STORED" message appears, the relay will be in "Programmed" state and the In Service LED will turn on.

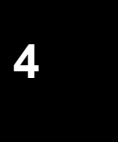

e) ENTERING INITIAL PASSWORDS

To enter the initial Setting (or Command) Password, proceed as follows:

1. Press the **MENU** key until the **SETTINGS** header flashes momentarily and the **SETTINGS PRODUCT SETUP** message appears on the display.
2. Press the MESSAGE **▶** key until the **ACCESS LEVEL** message appears on the display.
3. Press the MESSAGE **▼** key until the **CHANGE SETTING (or COMMAND) PASSWORD** message appears on the display.

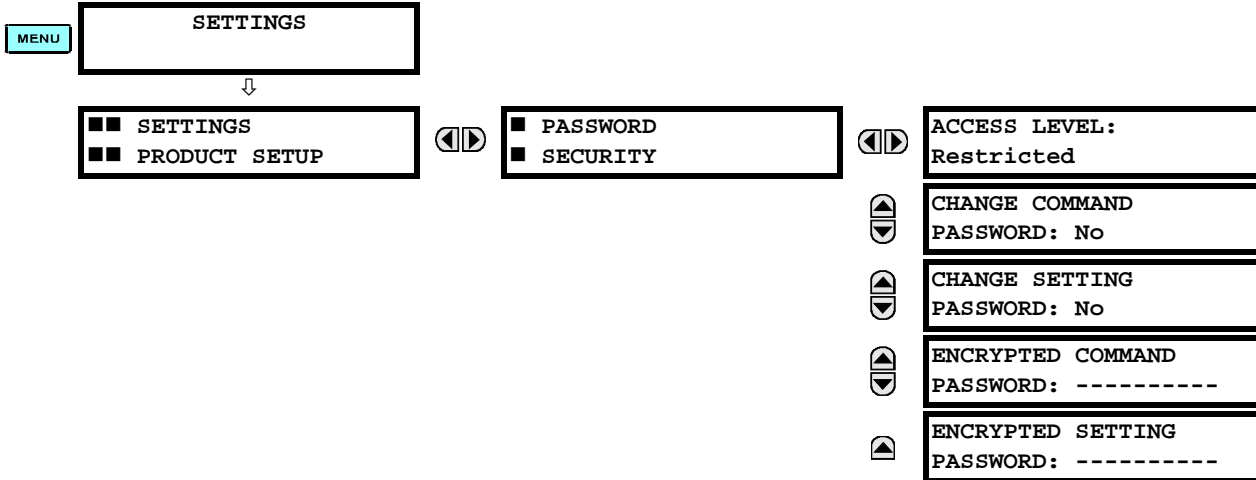

4. After the **CHANGE...PASSWORD** message appears on the display, press the VALUE **▲** key or the VALUE **▼** key to change the selection to "Yes".
5. Press the **ENTER** key and the display will prompt you to **ENTER NEW PASSWORD**.
6. Type in a numerical password (up to 10 characters) and press the **ENTER** key.
7. When the **VERIFY NEW PASSWORD** is displayed, re-type in the same password and press **ENTER**.

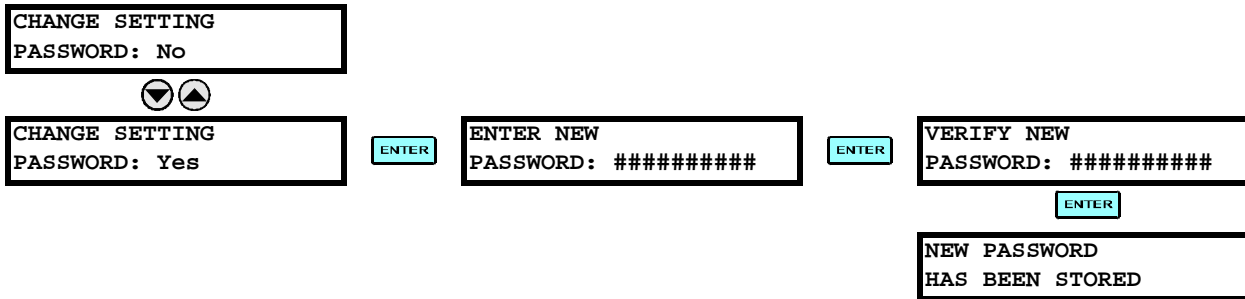

8. When the **NEW PASSWORD HAS BEEN STORED** message appears, your new Setting (or Command) Password will be active.

f) CHANGING EXISTING PASSWORDS

























To change an existing password, follow the instructions in the previous section with the following exception. A message will prompt you to type in the existing password (for each security level) before a new password can be entered.

In the event that a password has been lost (forgotten), submit the corresponding Encrypted Password from the **PASSWORD SECURITY** menu to the Factory for decoding.

g) INVALID PASSWORD ENTRY

In the event that an incorrect Command or Setting password has been entered via the faceplate interface three times within a three minute time span, the LOCAL ACCESS DENIED FlexLogic™ operand will be set to “On” and the T60 will not allow Settings or Command access via the faceplate interface for the next ten minutes. The **TOO MANY ATTEMPTS – BLOCKED FOR 10 MIN!** flash message will appear upon activation of the ten minute timeout or any other time a user attempts any change to the defined tier during the ten minute timeout. The LOCAL ACCESS DENIED FlexLogic™ operand will be set to “Off” after the expiration of the ten minute timeout.

5.1.1 SETTINGS MAIN MENU

<div style="border: 1px solid black; padding: 2px;"> ■■ SETTINGS ■■ PRODUCT SETUP </div>		<div style="border: 1px solid black; padding: 2px;"> ■ PASSWORD ■ SECURITY </div>	See page 5-7.
		<div style="border: 1px solid black; padding: 2px;"> ■ DISPLAY ■ PROPERTIES </div>	See page 5-8.
		<div style="border: 1px solid black; padding: 2px;"> ■ CLEAR RELAY ■ RECORDS </div>	See page 5-10.
		<div style="border: 1px solid black; padding: 2px;"> ■ COMMUNICATIONS ■ </div>	See page 5-11.
		<div style="border: 1px solid black; padding: 2px;"> ■ MODBUS USER MAP ■ </div>	See page 5-22.
		<div style="border: 1px solid black; padding: 2px;"> ■ REAL TIME ■ CLOCK </div>	See page 5-22.
		<div style="border: 1px solid black; padding: 2px;"> ■ USER-PROGRAMMABLE ■ FAULT REPORT </div>	See page 5-22.
		<div style="border: 1px solid black; padding: 2px;"> ■ OSCILLOGRAPHY ■ </div>	See page 5-23.
		<div style="border: 1px solid black; padding: 2px;"> ■ DATA LOGGER ■ </div>	See page 5-26.
		<div style="border: 1px solid black; padding: 2px;"> ■ DEMAND ■ </div>	See page 5-27.
		<div style="border: 1px solid black; padding: 2px;"> ■ USER-PROGRAMMABLE ■ LEDES </div>	See page 5-28.
		<div style="border: 1px solid black; padding: 2px;"> ■ USER-PROGRAMMABLE ■ SELF TESTS </div>	See page 5-32.
		<div style="border: 1px solid black; padding: 2px;"> ■ CONTROL ■ PUSHBUTTONS </div>	See page 5-33.
		<div style="border: 1px solid black; padding: 2px;"> ■ USER-PROGRAMMABLE ■ PUSHBUTTONS </div>	See page 5-34.
		<div style="border: 1px solid black; padding: 2px;"> ■ FLEX STATE ■ PARAMETERS </div>	See page 5-35.
		<div style="border: 1px solid black; padding: 2px;"> ■ USER-DEFINABLE ■ DISPLAYS </div>	See page 5-36.
		<div style="border: 1px solid black; padding: 2px;"> ■ DIRECT I/O ■ </div>	See page 5-38.
		<div style="border: 1px solid black; padding: 2px;"> ■ TELEPROTECTION ■ </div>	See page 5-43.
		<div style="border: 1px solid black; padding: 2px;"> ■ INSTALLATION ■ </div>	See page 5-44.
		<div style="border: 1px solid black; padding: 2px;"> ■ AC INPUTS ■ </div>	See page 5-45.
		<div style="border: 1px solid black; padding: 2px;"> ■ POWER SYSTEM ■ </div>	See page 5-47.

▲		■ SIGNAL SOURCES ■	See page 5-48.
▲		■ TRANSFORMER ■	See page 5-50.
▲		■ FLEXCURVES ■	See page 5-62.
▲	■ ■ SETTINGS ■ ■ FLEXLOGIC	■ FLEXLOGIC ■ EQUATION EDITOR	See page 5-82.
▼	▼	■ FLEXLOGIC ■ TIMERS	See page 5-82.
▲		■ FLEXELEMENTS ■	See page 5-83.
▲		■ NON-VOLATILE ■ LATCHES	See page 5-87.
▲	■ ■ SETTINGS ■ ■ GROUPED ELEMENTS	■ SETTING GROUP 1 ■	See page 5-88.
▼	▼	■ SETTING GROUP 2 ■	
		↓	
▲		■ SETTING GROUP 6 ■	
▲	■ ■ SETTINGS ■ ■ CONTROL ELEMENTS	■ SETTING GROUPS ■	See page 5-130.
▼	▼	■ SELECTOR SWITCH ■	See page 5-131.
▲		■ UNDERFREQUENCY ■	See page 5-137.
▲		■ OVERFREQUENCY ■	See page 5-138.
▲		■ DIGITAL ELEMENTS ■	See page 5-139.
▲		■ DIGITAL COUNTERS ■	See page 5-142.
▲		■ MONITORING ■ ELEMENTS	See page 5-144.
▲	■ ■ SETTINGS ■ ■ INPUTS / OUTPUTS	■ CONTACT INPUTS ■	See page 5-146.
▼	▼	■ VIRTUAL INPUTS ■	See page 5-148.
▲		■ CONTACT OUTPUTS ■	See page 5-149.

	▲▼	■ VIRTUAL OUTPUTS ■	See page 5-151.
	▲▼	■ REMOTE DEVICES ■	See page 5-152.
	▲▼	■ REMOTE INPUTS ■	See page 5-153.
	▲▼	■ REMOTE OUTPUTS ■ DNA BIT PAIRS	See page 5-154.
	▲▼	■ REMOTE OUTPUTS ■ UserSt BIT PAIRS	See page 5-154.
	▲▼	■ RESETTING ■	See page 5-155.
	▲▼	■ DIRECT INPUTS ■	See page 5-155.
	▲▼	■ DIRECT OUTPUTS ■	See page 5-155.
	▲	■ TELEPROTECTION ■	See page 5-159.
▲			
■ ■ SETTINGS ■ ■ TRANSDUCER I/O	◀▶	■ DCMA INPUTS ■	See page 5-161.
▼	▲▼	■ RTD INPUTS ■	See page 5-162.
	▲	■ DCMA OUTPUTS ■	See page 5-162.
▲			
■ ■ SETTINGS ■ ■ TESTING	◀▶	TEST MODE FUNCTION: Disabled	See page 5-166.
	▲▼	TEST MODE INITIATE: On	See page 5-166.
	▲▼	■ FORCE CONTACT ■ INPUTS	See page 5-166.
	▲	■ FORCE CONTACT ■ OUTPUTS	See page 5-167.

5.1.2 INTRODUCTION TO ELEMENTS

In the design of UR relays, the term “element” is used to describe a feature that is based around a comparator. The comparator is provided with an input (or set of inputs) that is tested against a programmed setting (or group of settings) to determine if the input is within the defined range that will set the output to logic 1, also referred to as “setting the flag”. A single comparator may make multiple tests and provide multiple outputs; for example, the time overcurrent comparator sets a Pickup flag when the current input is above the setting and sets an Operate flag when the input current has been at a level above the pickup setting for the time specified by the time-current curve settings. All comparators, except the Digital Element which uses a logic state as the input, use analog parameter actual values as the input.

Elements are arranged into two classes, GROUPED and CONTROL. Each element classed as a GROUPED element is provided with six alternate sets of settings, in setting groups numbered 1 through 6. The performance of a GROUPED element is defined by the setting group that is active at a given time. The performance of a CONTROL element is independent of the selected active setting group.

The main characteristics of an element are shown on the element logic diagram. This includes the input(s), settings, fixed logic, and the output operands generated (abbreviations used on scheme logic diagrams are defined in Appendix F).

Some settings for current and voltage elements are specified in per-unit (pu) calculated quantities:

pu quantity = (actual quantity) / (base quantity)

- For current elements, the 'base quantity' is the nominal secondary or primary current of the CT. Where the current source is the sum of two CTs with different ratios, the 'base quantity' will be the common secondary or primary current to which the sum is scaled (i.e. normalized to the larger of the 2 rated CT inputs). For example, if CT1 = 300 / 5 A and CT2 = 100 / 5 A, then in order to sum these, CT2 is scaled to the CT1 ratio. In this case, the 'base quantity' will be 5 A secondary or 300 A primary.
- For voltage elements the 'base quantity' is the nominal primary voltage of the protected system which corresponds (based on VT ratio and connection) to secondary VT voltage applied to the relay. For example, on a system with a 13.8 kV nominal primary voltage and with 14400:120 V Delta-connected VTs, the secondary nominal voltage (1 pu) would be:

$$\frac{13800}{14400} \times 120 = 115 \text{ V} \quad (\text{EQ 5.1})$$

For Wye-connected VTs, the secondary nominal voltage (1 pu) would be:

$$\frac{13800}{14400} \times \frac{120}{\sqrt{3}} = 66.4 \text{ V} \quad (\text{EQ 5.2})$$

Many settings are common to most elements and are discussed below:

- **FUNCTION setting:** This setting programs the element to be operational when selected as "Enabled". The factory default is "Disabled". Once programmed to "Enabled", any element associated with the Function becomes active and all options become available.
- **NAME setting:** This setting is used to uniquely identify the element.
- **SOURCE setting:** This setting is used to select the parameter or set of parameters to be monitored.
- **PICKUP setting:** For simple elements, this setting is used to program the level of the measured parameter above or below which the pickup state is established. In more complex elements, a set of settings may be provided to define the range of the measured parameters which will cause the element to pickup.
- **PICKUP DELAY setting:** This setting sets a time-delay-on-pickup, or on-delay, for the duration between the Pickup and Operate output states.
- **RESET DELAY setting:** This setting is used to set a time-delay-on-dropout, or off-delay, for the duration between the Operate output state and the return to logic 0 after the input transits outside the defined pickup range.
- **BLOCK setting:** The default output operand state of all comparators is a logic 0 or "flag not set". The comparator remains in this default state until a logic 1 is asserted at the RUN input, allowing the test to be performed. If the RUN input changes to logic 0 at any time, the comparator returns to the default state. The RUN input is used to supervise the comparator. The BLOCK input is used as one of the inputs to RUN control.
- **TARGET setting:** This setting is used to define the operation of an element target message. When set to Disabled, no target message or illumination of a faceplate LED indicator is issued upon operation of the element. When set to Self-Reset, the target message and LED indication follow the Operate state of the element, and self-resets once the operate element condition clears. When set to Latched, the target message and LED indication will remain visible after the element output returns to logic 0 - until a RESET command is received by the relay.
- **EVENTS setting:** This setting is used to control whether the Pickup, Dropout or Operate states are recorded by the event recorder. When set to Disabled, element pickup, dropout or operate are not recorded as events. When set to Enabled, events are created for:
 - (Element) PKP (pickup)
 - (Element) DPO (dropout)
 - (Element) OP (operate)

The DPO event is created when the measure and decide comparator output transits from the pickup state (logic 1) to the dropout state (logic 0). This could happen when the element is in the operate state if the reset delay time is not '0'.

5.1.3 INTRODUCTION TO AC SOURCES

a) BACKGROUND

The T60 may be used on systems with breaker-and-a-half or ring bus configurations. In these applications, each of the two three-phase sets of individual phase currents (one associated with each breaker) can be used as an input to a breaker failure element. The sum of both breaker phase currents and $3I_0$ residual currents may be required for the circuit relaying and metering functions. For a three-winding transformer application, it may be required to calculate watts and vars for each of three windings, using voltage from different sets of VTs. These requirements can be satisfied with a single UR, equipped with sufficient CT and VT input channels, by selecting the parameter to measure. A mechanism is provided to specify the AC parameter (or group of parameters) used as the input to protection/control comparators and some metering elements.

Selection of the parameter(s) to measure is partially performed by the design of a measuring element or protection/control comparator by identifying the type of parameter (fundamental frequency phasor, harmonic phasor, symmetrical component, total waveform RMS magnitude, phase-phase or phase-ground voltage, etc.) to measure. The user completes the process by selecting the instrument transformer input channels to use and some of the parameters calculated from these channels. The input parameters available include the summation of currents from multiple input channels. For the summed currents of phase, $3I_0$, and ground current, current from CTs with different ratios are adjusted to a single ratio before summation.

A mechanism called a “Source” configures the routing of CT and VT input channels to measurement sub-systems. Sources, in the context of UR series relays, refer to the logical grouping of current and voltage signals such that one source contains all the signals required to measure the load or fault in a particular power apparatus. A given source may contain all or some of the following signals: three-phase currents, single-phase ground current, three-phase voltages and an auxiliary voltage from a single VT for checking for synchronism.

To illustrate the concept of Sources, as applied to current inputs only, consider the breaker-and-a-half scheme below. In this application, the current flows as shown by the arrows. Some current flows through the upper bus bar to some other location or power equipment, and some current flows into transformer Winding 1. The current into Winding 1 is the phasor sum (or difference) of the currents in CT1 and CT2 (whether the sum or difference is used depends on the relative polarity of the CT connections). The same considerations apply to transformer Winding 2. The protection elements require access to the net current for transformer protection, but some elements may need access to the individual currents from CT1 and CT2.

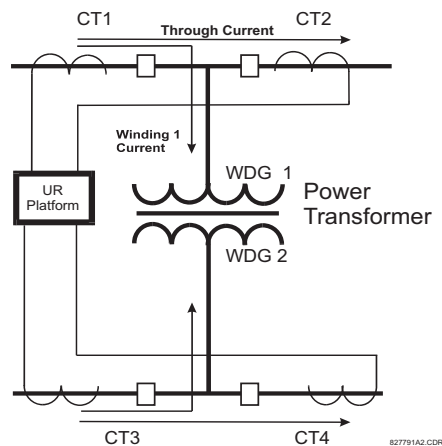

Figure 5–1: BREAKER-AND-A-HALF SCHEME

In conventional analog or electronic relays, the sum of the currents is obtained from an appropriate external connection of all CTs through which any portion of the current for the element being protected could flow. Auxiliary CTs are required to perform ratio matching if the ratios of the primary CTs to be summed are not identical. In the UR series of relays, provisions have been included for all the current signals to be brought to the UR device where grouping, ratio correction and summation are applied internally via configuration settings.

A major advantage of using internal summation is that the individual currents are available to the protection device; for example, as additional information to calculate a restraint current, or to allow the provision of additional protection features that operate on the individual currents such as breaker failure.

Given the flexibility of this approach, it becomes necessary to add configuration settings to the platform to allow the user to select which sets of CT inputs will be added to form the net current into the protected device.

The internal grouping of current and voltage signals forms an internal source. This source can be given a specific name through the settings, and becomes available to protection and metering elements in the UR platform. Individual names can be given to each source to help identify them more clearly for later use. For example, in the scheme shown in the above diagram, the configures one Source to be the sum of CT1 and CT2 and can name this Source as “Wdg 1 Current”.

Once the sources have been configured, the user has them available as selections for the choice of input signal for the protection elements and as metered quantities.

b) CT/VT MODULE CONFIGURATION

CT and VT input channels are contained in CT/VT modules. The type of input channel can be phase/neutral/other voltage, phase/ground current, or sensitive ground current. The CT/VT modules calculate total waveform RMS levels, fundamental frequency phasors, symmetrical components and harmonics for voltage or current, as allowed by the hardware in each channel. These modules may calculate other parameters as directed by the CPU module.

A CT/VT module contains up to eight input channels, numbered 1 through 8. The channel numbering corresponds to the module terminal numbering 1 through 8 and is arranged as follows: Channels 1, 2, 3 and 4 are always provided as a group, hereafter called a “bank,” and all four are either current or voltage, as are Channels 5, 6, 7 and 8. Channels 1, 2, 3 and 5, 6, 7 are arranged as phase A, B and C respectively. Channels 4 and 8 are either another current or voltage.

Banks are ordered sequentially from the block of lower-numbered channels to the block of higher-numbered channels, and from the CT/VT module with the lowest slot position letter to the module with the highest slot position letter, as follows:

INCREASING SLOT POSITION LETTER -->		
CT/VT MODULE 1	CT/VT MODULE 2	CT/VT MODULE 3
< bank 1 >	< bank 3 >	< bank 5 >
< bank 2 >	< bank 4 >	< bank 6 >

The UR platform allows for a maximum of three sets of three-phase voltages and six sets of three-phase currents. The result of these restrictions leads to the maximum number of CT/VT modules in a chassis to three. The maximum number of sources is six. A summary of CT/VT module configurations is shown below.

ITEM	MAXIMUM NUMBER
CT/VT Module	2
CT Bank (3 phase channels, 1 ground channel)	8
VT Bank (3 phase channels, 1 auxiliary channel)	4

c) CT/VT INPUT CHANNEL CONFIGURATION

Upon relay startup, configuration settings for every bank of current or voltage input channels in the relay are automatically generated from the order code. Within each bank, a channel identification label is automatically assigned to each bank of channels in a given product. The ‘bank’ naming convention is based on the physical location of the channels, required by the user to know how to connect the relay to external circuits. Bank identification consists of the letter designation of the slot in which the CT/VT module is mounted as the first character, followed by numbers indicating the channel, either 1 or 5.

For three-phase channel sets, the number of the lowest numbered channel identifies the set. For example, F1 represents the three-phase channel set of F1/F2/F3, where F is the slot letter and 1 is the first channel of the set of three channels.









Upon startup, the CPU configures the settings required to characterize the current and voltage inputs, and will display them in the appropriate section in the sequence of the banks (as described above) as follows for a maximum configuration: F1, F5, M1, M5, U1, and U5.

The above section explains how the input channels are identified and configured to the specific application instrument transformers and the connections of these transformers. The specific parameters to be used by each measuring element and comparator, and some actual values are controlled by selecting a specific source. The source is a group of current and voltage input channels selected by the user to facilitate this selection. With this mechanism, a user does not have to make multiple selections of voltage and current for those elements that need both parameters, such as a distance element or a watt calculation. It also gathers associated parameters for display purposes.

The basic idea of arranging a source is to select a point on the power system where information is of interest. An application example of the grouping of parameters in a Source is a transformer winding, on which a three phase voltage is measured, and the sum of the currents from CTs on each of two breakers is required to measure the winding current flow.

5.2.1 PASSWORD SECURITY

PATH: SETTINGS ⇨ PRODUCT SETUP ⇨ PASSWORD SECURITY

<div style="border: 1px solid black; padding: 2px;"> <input type="checkbox"/> PASSWORD <input checked="" type="checkbox"/> SECURITY </div>		<div style="border: 1px solid black; padding: 2px;"> ACCESS LEVEL: Restricted </div>	<i>Range: Restricted, Command, Setting, Factory Service (for factory use only)</i>
MESSAGE	 	<div style="border: 1px solid black; padding: 2px;"> CHANGE COMMAND PASSWORD: No </div>	<i>Range: No, Yes</i>
MESSAGE	 	<div style="border: 1px solid black; padding: 2px;"> CHANGE SETTING PASSWORD: No </div>	<i>Range: No, Yes</i>
MESSAGE	 	<div style="border: 1px solid black; padding: 2px;"> ENCRYPTED COMMAND PASSWORD: ----- </div>	<i>Range: 0 to 9999999999 Note: ----- indicates no password</i>
MESSAGE		<div style="border: 1px solid black; padding: 2px;"> ENCRYPTED SETTING PASSWORD: ----- </div>	<i>Range: 0 to 9999999999 Note: ----- indicates no password</i>

Two levels of password security are provided: **Command** and **Setting**. Operations under password supervision are:

- **COMMAND:** changing the state of virtual inputs, clearing the event records, clearing the oscillography records, changing the date and time, clearing energy records, clearing the data logger, user-programmable pushbuttons
- **SETTING:** changing any setting, test mode operation

The Command and Setting passwords are defaulted to "Null" when the relay is shipped from the factory. When a password is set to "Null", the password security feature is disabled.

Programming a password code is required to enable each access level. A password consists of 1 to 10 numerical characters. When a **CHANGE ... PASSWORD** setting is set to "Yes", the following message sequence is invoked:

1. ENTER NEW PASSWORD: _____
2. VERIFY NEW PASSWORD: _____
3. NEW PASSWORD HAS BEEN STORED

To gain write access to a "Restricted" setting, set **ACCESS LEVEL** to "Setting" and then change the setting, or attempt to change the setting and follow the prompt to enter the programmed password. If the password is correctly entered, access will be allowed. If no keys are pressed for longer than 30 minutes or control power is cycled, accessibility will automatically revert to the "Restricted" level.

If an entered password is lost (or forgotten), consult the factory with the corresponding **ENCRYPTED PASSWORD**.

The T60 provides a means to raise an alarm upon failed password entry. Should password verification fail while accessing a password-protected level of the relay (either settings or commands), the UNAUTHORIZED ACCESS FlexLogic™ operand is asserted. The operand can be programmed to raise an alarm via contact outputs or communications. This feature can be used to protect against both unauthorized and accidental access attempts.

The UNAUTHORIZED ACCESS operand is reset with the **COMMANDS** ⇨⇩ **CLEAR RECORDS** ⇨⇩ **RESET UNAUTHORIZED ALARMS** command. Therefore, to apply this feature with security, the command level should be password-protected.

The operand does not generate events or targets. If these are required, the operand can be assigned to a digital element programmed with event logs and/or targets enabled.



If the SETTING and COMMAND passwords are identical, this one password allows access to both commands and settings.



When EnerVista UR Setup is used to access a particular level, the user will continue to have access to that level as long as there are open windows in the EnerVista UR Setup software. To re-establish the Password Security feature, all windows must be closed for at least 30 minutes.

5.2.2 DISPLAY PROPERTIES

PATH: SETTINGS ⇒ PRODUCT SETUP ⇨ DISPLAY PROPERTIES

<ul style="list-style-type: none"> ■ DISPLAY ■ PROPERTIES 	◀▶	LANGUAGE: English	Range: English; English, French; English, Russian; English, Chinese (range dependent on order code)
MESSAGE	▲▼	FLASH MESSAGE TIME: 1.0 s	Range: 0.5 to 10.0 s in steps of 0.1
MESSAGE	▲▼	DEFAULT MESSAGE TIMEOUT: 300 s	Range: 10 to 900 s in steps of 1
MESSAGE	▲▼	DEFAULT MESSAGE INTENSITY: 25 %	Range: 25%, 50%, 75%, 100% Visible only if a VFD is installed
MESSAGE	▲▼	SCREEN SAVER FEATURE: Disabled	Range: Disabled, Enabled Visible only if an LCD is installed
MESSAGE	▲▼	SCREEN SAVER WAIT TIME: 30 min	Range: 1 to 65535 min. in steps of 1 Visible only if an LCD is installed
MESSAGE	▲▼	CURRENT CUT-OFF LEVEL: 0.020 pu	Range: 0.002 to 0.020 pu in steps of 0.001
MESSAGE	▲	VOLTAGE CUT-OFF LEVEL: 1.0 V	Range: 0.1 to 1.0 V secondary in steps of 0.1

5 Some relay messaging characteristics can be modified to suit different situations using the display properties settings.

- **LANGUAGE:** This setting selects the language used to display settings, actual values, and targets. The range is dependent on the order code of the relay.
- **FLASH MESSAGE TIME:** Flash messages are status, warning, error, or information messages displayed for several seconds in response to certain key presses during setting programming. These messages override any normal messages. The duration of a flash message on the display can be changed to accommodate different reading rates.
- **DEFAULT MESSAGE TIMEOUT:** If the keypad is inactive for a period of time, the relay automatically reverts to a default message. The inactivity time is modified via this setting to ensure messages remain on the screen long enough during programming or reading of actual values.
- **DEFAULT MESSAGE INTENSITY:** To extend phosphor life in the vacuum fluorescent display, the brightness can be attenuated during default message display. During keypad interrogation, the display always operates at full brightness.
- **SCREEN SAVER FEATURE** and **SCREEN SAVER WAIT TIME:** These settings are only visible if the T60 has a liquid crystal display (LCD) and control its backlighting. When the **SCREEN SAVER FEATURE** is "Enabled", the LCD backlighting is turned off after the **DEFAULT MESSAGE TIMEOUT** followed by the **SCREEN SAVER WAIT TIME**, providing that no keys have been pressed and no target messages are active. When a keypress occurs or a target becomes active, the LCD backlighting is turned on.
- **CURRENT CUT-OFF LEVEL:** This setting modifies the current cut-off threshold. Very low currents (1 to 2% of the rated value) are very susceptible to noise. Some customers prefer very low currents to display as zero, while others prefer the current be displayed even when the value reflects noise rather than the actual signal. The T60 applies a cut-off value to the magnitudes and angles of the measured currents. If the magnitude is below the cut-off level, it is substituted with zero. This applies to phase and ground current phasors as well as true RMS values and symmetrical components. The cut-off operation applies to quantities used for metering, protection, and control, as well as those used by communications protocols. Note that the cut-off level for the sensitive ground input is 10 times lower than the **CURRENT CUT-OFF LEVEL** setting value. Raw current samples available via oscillography are not subject to cut-off.
- **VOLTAGE CUT-OFF LEVEL:** This setting modifies the voltage cut-off threshold. Very low secondary voltage measurements (at the fractional volt level) can be affected by noise. Some customers prefer these low voltages to be displayed as zero, while others prefer the voltage to be displayed even when the value reflects noise rather than the actual signal. The T60 applies a cut-off value to the magnitudes and angles of the measured voltages. If the magnitude is below the cut-off level, it is substituted with zero. This operation applies to phase and auxiliary voltages, and symmetrical

components. The cut-off operation applies to quantities used for metering, protection, and control, as well as those used by communications protocols. Raw samples of the voltages available via oscillography are not subject cut-off.

The **CURRENT CUT-OFF LEVEL** and the **VOLTAGE CUT-OFF LEVEL** are used to determine the metered power cut-off levels. The power cut-off level is calculated as shown below. For Delta connections:

$$\text{3-phase power cut-off} = \frac{\sqrt{3} \times \text{CURRENT CUT-OFF LEVEL} \times \text{VOLTAGE CUT-OFF LEVEL} \times \text{VT primary} \times \text{CT primary}}{\text{VT secondary}} \quad (\text{EQ 5.3})$$

For Wye connections:

$$\text{3-phase power cut-off} = \frac{3 \times \text{CURRENT CUT-OFF LEVEL} \times \text{VOLTAGE CUT-OFF LEVEL} \times \text{VT primary} \times \text{CT primary}}{\text{VT secondary}} \quad (\text{EQ 5.4})$$

$$\text{per-phase power cut-off} = \frac{\text{CURRENT CUT-OFF LEVEL} \times \text{VOLTAGE CUT-OFF LEVEL} \times \text{VT primary} \times \text{CT primary}}{\text{VT secondary}} \quad (\text{EQ 5.5})$$

where VT primary = VT secondary × VT ratio and CT primary = CT secondary × CT ratio.

For example, given the following settings:

CURRENT CUT-OFF LEVEL: "0.02 pu"
VOLTAGE CUT-OFF LEVEL: "1.0 V"
PHASE CT PRIMARY: "100 A"
PHASE VT SECONDARY: "66.4 V"
PHASE VT RATIO: "208.00 : 1"
PHASE VT CONNECTION: "Delta".

We have:

CT primary = "100 A", and

VT primary = **PHASE VT SECONDARY** × **PHASE VT RATIO** = 66.4 V × 208 = 13811.2 V

The power cut-off is therefore:

$$\begin{aligned} \text{power cut-off} &= (\text{CURRENT CUT-OFF LEVEL} \times \text{VOLTAGE CUT-OFF LEVEL} \times \text{CT primary} \times \text{VT primary}) / \text{VT secondary} \\ &= (\sqrt{3} \times 0.02 \text{ pu} \times 1.0 \text{ V} \times 100 \text{ A} \times 13811.2 \text{ V}) / 66.4 \text{ V} \\ &= 720.5 \text{ watts} \end{aligned}$$

Any calculated power value below this cut-off will not be displayed. As well, the three-phase energy data will not accumulate if the total power from all three phases does not exceed the power cut-off.



Lower the VOLTAGE CUT-OFF LEVEL and CURRENT CUT-OFF LEVEL with care as the relay accepts lower signals as valid measurements. Unless dictated otherwise by a specific application, the default settings of "0.02 pu" for CURRENT CUT-OFF LEVEL and "1.0 V" for VOLTAGE CUT-OFF LEVEL are recommended.

5.2.3 CLEAR RELAY RECORDS

PATH: SETTINGS ⇒ PRODUCT SETUP ⇒ CLEAR RELAY RECORDS

<div style="border: 1px solid black; padding: 2px;"> ■ CLEAR RELAY ■ RECORDS </div>		<div style="border: 1px solid black; padding: 2px;"> CLEAR USER REPORTS : Off </div>	Range: FlexLogic™ operand
MESSAGE	▲▼	<div style="border: 1px solid black; padding: 2px;"> CLEAR EVENT RECORDS : Off </div>	Range: FlexLogic™ operand
MESSAGE	▲▼	<div style="border: 1px solid black; padding: 2px;"> CLEAR OSCILLOGRAPHY? No </div>	Range: FlexLogic™ operand
MESSAGE	▲▼	<div style="border: 1px solid black; padding: 2px;"> CLEAR DATA LOGGER : Off </div>	Range: FlexLogic™ operand
MESSAGE	▲▼	<div style="border: 1px solid black; padding: 2px;"> CLEAR ARC AMPS 1 : Off </div>	Range: FlexLogic™ operand
MESSAGE	▲▼	<div style="border: 1px solid black; padding: 2px;"> CLEAR ARC AMPS 2 : Off </div>	Range: FlexLogic™ operand
MESSAGE	▲▼	<div style="border: 1px solid black; padding: 2px;"> CLEAR DEMAND : Off </div>	Range: FlexLogic™ operand
MESSAGE	▲▼	<div style="border: 1px solid black; padding: 2px;"> CLEAR ENERGY : Off </div>	Range: FlexLogic™ operand
MESSAGE	▲▼	<div style="border: 1px solid black; padding: 2px;"> RESET UNAUTH ACCESS : Off </div>	Range: FlexLogic™ operand
MESSAGE	▲	<div style="border: 1px solid black; padding: 2px;"> CLEAR DIR I/O STATS : Off </div>	Range: FlexLogic™ operand. Valid only for units with Direct I/O module.

Selected records can be cleared from user-programmable conditions with FlexLogic™ operands. Assigning user-programmable pushbuttons to clear specific records are typical applications for these commands. Since the T60 responds to rising edges of the configured FlexLogic™ operands, they must be asserted for at least 50 ms to take effect.

Clearing records with user-programmable operands is not protected by the command password. However, user-programmable pushbuttons are protected by the command password. Thus, if they are used to clear records, the user-programmable pushbuttons can provide extra security if required.

For example, to assign User-Programmable Pushbutton 1 to clear demand records, the following settings should be applied.

- Assign the clear demand function to Pushbutton 1 by making the following change in the **SETTINGS ⇒ PRODUCT SETUP ⇒ CLEAR RELAY RECORDS** menu:

CLEAR DEMAND: "PUSHBUTTON 1 ON"
- Set the properties for User-Programmable Pushbutton 1 by making the following changes in the **SETTINGS ⇒ PRODUCT SETUP ⇒ USER-PROGRAMMABLE PUSHBUTTONS ⇒ USER PUSHBUTTON 1** menu:

PUSHBUTTON 1 FUNCTION: "Self-reset"

PUSHBTN 1 DROP-OUT TIME: "0.20 s"

5.2.4 COMMUNICATIONS

a) MAIN MENU

PATH: SETTINGS ⇨ PRODUCT SETUP ⇨ COMMUNICATIONS

■ COMMUNICATIONS	◀▶	■ SERIAL PORTS	See below.
MESSAGE	▲▼	■ NETWORK	See page 5-12.
MESSAGE	▲▼	■ MODBUS PROTOCOL	See page 5-12.
MESSAGE	▲▼	■ DNP PROTOCOL	See page 5-13.
MESSAGE	▲▼	■ DNP / IEC104 ■ POINT LISTS	See page 5-15.
MESSAGE	▲▼	■ IEC 61850 PROTOCOL	See page 5-16.
MESSAGE	▲▼	■ WEB SERVER ■ HTTP PROTOCOL	See page 5-18.
MESSAGE	▲▼	■ TFTP PROTOCOL	See page 5-19.
MESSAGE	▲▼	■ IEC 60870-5-104 ■ PROTOCOL	See page 5-19.
MESSAGE	▲▼	■ SNTP PROTOCOL	See page 5-20.
MESSAGE	▲	■ EGD PROTOCOL	See page 5-20.

b) SERIAL PORTS

PATH: SETTINGS ⇨ PRODUCT SETUP ⇨ COMMUNICATIONS ⇨ SERIAL PORTS

■ SERIAL PORTS	◀▶	RS485 COM1 BAUD RATE: 19200	Range: 300, 1200, 2400, 4800, 9600, 14400, 19200, 28800, 33600, 38400, 57600, 115200. Only active if CPU 9E is ordered.
MESSAGE	▲▼	RS485 COM1 PARITY: None	Range: None, Odd, Even Only active if CPU Type 9E is ordered
MESSAGE	▲▼	RS485 COM1 RESPONSE MIN TIME: 0 ms	Range: 0 to 1000 ms in steps of 10 Only active if CPU Type 9E is ordered
MESSAGE	▲▼	RS485 COM2 BAUD RATE: 19200	Range: 300, 1200, 2400, 4800, 9600, 14400, 19200, 28800, 33600, 38400, 57600, 115200
MESSAGE	▲▼	RS485 COM2 PARITY: None	Range: None, Odd, Even
MESSAGE	▲	RS485 COM2 RESPONSE MIN TIME: 0 ms	Range: 0 to 1000 ms in steps of 10

The T60 is equipped with up to 3 independent serial communication ports. The faceplate RS232 port is intended for local use and is fixed at 19200 baud and no parity. The rear COM1 port type is selected when ordering: either an Ethernet or RS485 port. The rear COM2 port is RS485. The RS485 ports have settings for baud rate and parity. It is important that these parameters agree with the settings used on the computer or other equipment that is connected to these ports. Any of

these ports may be connected to a computer running EnerVista UR Setup. This software can download and upload setting files, view measured parameters, and upgrade the relay firmware. A maximum of 32 relays can be daisy-chained and connected to a DCS, PLC or PC using the RS485 ports.



For each RS485 port, the minimum time before the port will transmit after receiving data from a host can be set. This feature allows operation with hosts which hold the RS485 transmitter active for some time after each transmission.

c) NETWORK

PATH: SETTINGS ⇒ PRODUCT SETUP ⇨ COMMUNICATIONS ⇨ NETWORK

<input checked="" type="checkbox"/> NETWORK <input type="checkbox"/>		IP ADDRESS: 0.0.0.0	Range: Standard IP address format Not shown if CPU Type 9E is ordered.
	MESSAGE	SUBNET IP MASK: 0.0.0.0	Range: Standard IP address format Not shown if CPU Type 9E is ordered.
	MESSAGE	GATEWAY IP ADDRESS: 0.0.0.0	Range: Standard IP address format Not shown if CPU Type 9E is ordered.
	MESSAGE	<input checked="" type="checkbox"/> OSI NETWORK <input checked="" type="checkbox"/> ADDRESS (NSAP)	Range: Select to enter the OSI NETWORK ADDRESS. Not shown if CPU Type 9E is ordered.
	MESSAGE	ETHERNET OPERATION MODE: Full-Duplex	Range: Half-Duplex, Full-Duplex Not shown if CPU Type 9E or 9N is ordered.

These messages appear only if the T60 is ordered with an Ethernet card.

The IP addresses are used with the DNP, Modbus/TCP, IEC 61580, IEC 60870-5-104, TFTP, and HTTP protocols. The NSAP address is used with the IEC 61850 protocol over the OSI (CLNP/TP4) stack only. Each network protocol has a setting for the **TCP/UDP PORT NUMBER**. These settings are used only in advanced network configurations and should normally be left at their default values, but may be changed if required (for example, to allow access to multiple UR-series relays behind a router). By setting a different **TCP/UDP PORT NUMBER** for a given protocol on each UR-series relay, the router can map the relays to the same external IP address. The client software (EnerVista UR Setup, for example) must be configured to use the correct port number if these settings are used.



When the NSAP address, any TCP/UDP Port Number, or any User Map setting (when used with DNP) is changed, it will not become active until power to the relay has been cycled (OFF/ON).



Do not set more than one protocol to use the same TCP/UDP PORT NUMBER, as this will result in unreliable operation of those protocols.

d) MODBUS PROTOCOL

PATH: SETTINGS ⇒ PRODUCT SETUP ⇨ COMMUNICATIONS ⇨ MODBUS PROTOCOL

<input checked="" type="checkbox"/> MODBUS PROTOCOL <input type="checkbox"/>		MODBUS SLAVE ADDRESS: 254	Range: 1 to 254 in steps of 1
	MESSAGE	MODBUS TCP PORT NUMBER: 502	Range: 1 to 65535 in steps of 1

The serial communication ports utilize the Modbus protocol, unless configured for DNP or IEC 60870-5-104 operation (see descriptions below). This allows the EnerVista UR Setup software to be used. The UR operates as a Modbus slave device only. When using Modbus protocol on the RS232 port, the T60 will respond regardless of the **MODBUS SLAVE ADDRESS** programmed. For the RS485 ports each T60 must have a unique address from 1 to 254. Address 0 is the broadcast address which all Modbus slave devices listen to. Addresses do not have to be sequential, but no two devices can have the same address or conflicts resulting in errors will occur. Generally, each device added to the link should use the next higher address starting at 1. Refer to Appendix B for more information on the Modbus protocol.



Changes to the MODBUS TCP PORT NUMBER setting will not take effect until the T60 is restarted.

e) DNP PROTOCOL

PATH: SETTINGS ⇨ PRODUCT SETUP ⇨ COMMUNICATIONS ⇨ DNP PROTOCOL

<input checked="" type="checkbox"/> DNP PROTOCOL		<input checked="" type="checkbox"/> DNP CHANNELS	Range: see sub-menu below
MESSAGE		DNP ADDRESS: 65519	Range: 0 to 65519 in steps of 1
MESSAGE		<input checked="" type="checkbox"/> DNP NETWORK <input checked="" type="checkbox"/> CLIENT ADDRESSES	Range: see sub-menu below
MESSAGE		DNP TCP/UDP PORT NUMBER: 20000	Range: 1 to 65535 in steps of 1
MESSAGE		DNP UNSOL RESPONSE FUNCTION: Disabled	Range: Enabled, Disabled
MESSAGE		DNP UNSOL RESPONSE TIMEOUT: 5 s	Range: 0 to 60 s in steps of 1
MESSAGE		DNP UNSOL RESPONSE MAX RETRIES: 10	Range: 1 to 255 in steps of 1
MESSAGE		DNP UNSOL RESPONSE DEST ADDRESS: 1	Range: 0 to 65519 in steps of 1
MESSAGE		DNP CURRENT SCALE FACTOR: 1	Range: 0.001, 0.01, 0.1, 1, 10, 100, 1000, 10000, 100000
MESSAGE		DNP VOLTAGE SCALE FACTOR: 1	Range: 0.001, 0.01, 0.1, 1, 10, 100, 1000, 10000, 100000
MESSAGE		DNP POWER SCALE FACTOR: 1	Range: 0.001, 0.01, 0.1, 1, 10, 100, 1000, 10000, 100000
MESSAGE		DNP ENERGY SCALE FACTOR: 1	Range: 0.001, 0.01, 0.1, 1, 10, 100, 1000, 10000, 100000
MESSAGE		DNP OTHER SCALE FACTOR: 1	Range: 0.001, 0.01, 0.1, 1, 10, 100, 1000, 10000, 100000
MESSAGE		DNP CURRENT DEFAULT DEADBAND: 30000	Range: 0 to 65535 in steps of 1
MESSAGE		DNP VOLTAGE DEFAULT DEADBAND: 30000	Range: 0 to 65535 in steps of 1
MESSAGE		DNP POWER DEFAULT DEADBAND: 30000	Range: 0 to 65535 in steps of 1
MESSAGE		DNP ENERGY DEFAULT DEADBAND: 30000	Range: 0 to 65535 in steps of 1
MESSAGE		DNP OTHER DEFAULT DEADBAND: 30000	Range: 0 to 65535 in steps of 1
MESSAGE		DNP TIME SYNC IIN PERIOD: 1440 min	Range: 1 to 10080 min. in steps of 1
MESSAGE		DNP MESSAGE FRAGMENT SIZE: 240	Range: 30 to 2048 in steps of 1
MESSAGE		DNP OBJECT 1 DEFAULT VARIATION: 2	Range: 1, 2

MESSAGE	▲▼	DNP OBJECT 2 DEFAULT VARIATION: 2	Range: 1, 2
MESSAGE	▲▼	DNP OBJECT 20 DEFAULT VARIATION: 1	Range: 1, 2, 5, 6
MESSAGE	▲▼	DNP OBJECT 21 DEFAULT VARIATION: 1	Range: 1, 2, 9, 10
MESSAGE	▲▼	DNP OBJECT 22 DEFAULT VARIATION: 1	Range: 1, 2, 5, 6
MESSAGE	▲▼	DNP OBJECT 23 DEFAULT VARIATION: 2	Range: 1, 2, 5, 6
MESSAGE	▲▼	DNP OBJECT 30 DEFAULT VARIATION: 1	Range: 1, 2, 3, 4, 5
MESSAGE	▲▼	DNP OBJECT 32 DEFAULT VARIATION: 1	Range: 1, 2, 3, 4, 5, 7
MESSAGE	▲	DNP NUMBER OF PAIRED CONTROL POINTS: 0	Range: 0 to 32 in steps of 1

The T60 supports the Distributed Network Protocol (DNP) version 3.0. The T60 can be used as a DNP slave device connected to multiple DNP masters (usually an RTU or a SCADA master station). Since the T60 maintains two sets of DNP data change buffers and connection information, two DNP masters can actively communicate with the T60 at one time.

The DNP Channels sub-menu is shown below.

PATH: SETTINGS ⇒ PRODUCT SETUP ⇒ COMMUNICATIONS ⇒ DNP PROTOCOL ⇒ DNP CHANNELS

■ DNP CHANNELS	◀▶	DNP CHANNEL 1 PORT: NETWORK	Range: NONE, COM1 - RS485, COM2 - RS485, FRONT PANEL - RS232, NETWORK
MESSAGE	▲	DNP CHANNEL 2 PORT: COM2 - RS485	Range: NONE, COM1 - RS485, COM2 - RS485, FRONT PANEL - RS232, NETWORK

The DNP CHANNEL 1(2) PORT settings select the communications port assigned to the DNP protocol for each channel. Once DNP is assigned to a serial port, the Modbus protocol is disabled on that port. Note that COM1 can be used only in non-Ethernet UR relays. When this setting is set to “Network”, the DNP protocol can be used over either TCP/IP or UDP/IP. Refer to Appendix E for additional information on the DNP protocol.

The DNP NETWORK CLIENT ADDRESS settings can force the T60 to respond to a maximum of five specific DNP masters. The settings in this sub-menu are shown below.

PATH: SETTINGS ⇒ PRODUCT SETUP ⇒ COMMUNICATIONS ⇒ DNP PROTOCOL ⇒ DNP NETWORK CLIENT ADDRESSES

■ DNP NETWORK	◀▶	CLIENT ADDRESS 1: 0.0.0.0	Range: standard IP address
■ CLIENT ADDRESSES	▲▼	CLIENT ADDRESS 2: 0.0.0.0	Range: standard IP address
MESSAGE	▲▼	CLIENT ADDRESS 3: 0.0.0.0	Range: standard IP address
MESSAGE	▲▼	CLIENT ADDRESS 4: 0.0.0.0	Range: standard IP address
MESSAGE	▲	CLIENT ADDRESS 5: 0.0.0.0	Range: standard IP address

The DNP UNSOL RESPONSE FUNCTION should be “Disabled” for RS485 applications since there is no collision avoidance mechanism. The DNP UNSOL RESPONSE TIMEOUT sets the time the T60 waits for a DNP master to confirm an unsolicited response. The DNP UNSOL RESPONSE MAX RETRIES setting determines the number of times the T60 retransmits an unsolic-

ited response without receiving confirmation from the master; a value of “255” allows infinite re-tries. The **DNP UNSOL RESPONSE DEST ADDRESS** is the DNP address to which all unsolicited responses are sent. The IP address to which unsolicited responses are sent is determined by the T60 from the current TCP connection or the most recent UDP message.

The **DNP SCALE FACTOR** settings are numbers used to scale Analog Input point values. These settings group the T60 Analog Input data into types: current, voltage, power, energy, and other. Each setting represents the scale factor for all Analog Input points of that type. For example, if the **DNP VOLTAGE SCALE FACTOR** setting is set to a value of 1000, all DNP Analog Input points that are voltages will be returned with values 1000 times smaller (e.g. a value of 72000 V on the T60 will be returned as 72). These settings are useful when analog input values must be adjusted to fit within certain ranges in DNP masters. Note that a scale factor of 0.1 is equivalent to a multiplier of 10 (i.e. the value will be 10 times larger).

The **DNP DEFAULT DEADBAND** settings determine when to trigger unsolicited responses containing Analog Input data. These settings group the T60 Analog Input data into types: current, voltage, power, energy, and other. Each setting represents the default deadband value for all Analog Input points of that type. For example, to trigger unsolicited responses from the T60 when any current values change by 15 A, the **DNP CURRENT DEFAULT DEADBAND** setting should be set to “15”. Note that these settings are the deadband default values. DNP Object 34 points can be used to change deadband values, from the default, for each individual DNP Analog Input point. Whenever power is removed and re-applied to the T60, the default deadbands will be in effect.

The **DNP TIME SYNC IIN PERIOD** setting determines how often the Need Time Internal Indication (IIN) bit is set by the T60. Changing this time allows the DNP master to send time synchronization commands more or less often, as required.

The **DNP MESSAGE FRAGMENT SIZE** setting determines the size, in bytes, at which message fragmentation occurs. Large fragment sizes allow for more efficient throughput; smaller fragment sizes cause more application layer confirmations to be necessary which can provide for more robust data transfer over noisy communication channels.



When the DNP data points (analog inputs and/or binary inputs) are configured for Ethernet-enabled relays, check the “DNP Points Lists” T60 web page to view the points lists. This page can be viewed with a web browser by entering the T60 IP address to access the T60 “Main Menu”, then by selecting the “Device Information Menu” > “DNP Points Lists” menu item.

The **DNP OBJECT N DEFAULT VARIATION** settings allow the user to select the DNP default variation number for object types 1, 2, 20, 21, 22, 23, 30, and 32. The default variation refers to the variation response when variation 0 is requested and/or in class 0, 1, 2, or 3 scans. Refer to the *DNP Implementation* section in Appendix E for additional details.

The DNP binary outputs typically map one-to-one to IED data points. That is, each DNP binary output controls a single physical or virtual control point in an IED. In the T60 relay, DNP binary outputs are mapped to virtual inputs. However, some legacy DNP implementations use a mapping of one DNP binary output to two physical or virtual control points to support the concept of trip/close (for circuit breakers) or raise/lower (for tap changers) using a single control point. That is, the DNP master can operate a single point for both trip and close, or raise and lower, operations. The T60 can be configured to support paired control points, with each paired control point operating two virtual inputs. The **DNP NUMBER OF PAIRED CONTROL POINTS** setting allows configuration of from 0 to 32 binary output paired controls. Points not configured as paired operate on a one-to-one basis.

The **DNP ADDRESS** setting is the DNP slave address. This number identifies the T60 on a DNP communications link. Each DNP slave should be assigned a unique address.

f) DNP / IEC 60870-5-104 POINT LISTS

PATH: SETTINGS ⇨ PRODUCT SETUP ⇨ COMMUNICATIONS ⇨ DNP / IEC104 POINT LISTS

■ DNP / IEC104 ■ POINT LISTS		■ BINARY INPUT / MSP ■ POINTS	<i>Range: see sub-menu below</i>
MESSAGE		■ ANALOG INPUT / MME ■ POINTS	<i>Range: see sub-menu below</i>

The binary and analog inputs points for the DNP protocol, or the MSP and MME points for IEC 60870-5-104 protocol, can be configured to a maximum of 256 points. The value for each point is user-programmable and can be configured by assigning FlexLogic™ operands for binary inputs / MSP points or FlexAnalog parameters for analog inputs / MME points.

The menu for the binary input points (DNP) or MSP points (IEC 60870-5-104) is shown below.

PATH: SETTINGS ⇒ PRODUCT SETUP ⇒ COMMUNICATIONS ⇒ DNP / IEC104 POINT LISTS ⇒ BINARY INPUT / MSP POINTS

<input checked="" type="checkbox"/> BINARY INPUT / MSP <input checked="" type="checkbox"/> POINTS	<input type="button" value="◀"/> <input type="button" value="▶"/>	Point: 0 Off	Range: FlexLogic™ operand
	MESSAGE <input type="button" value="▲"/>	Point: 1 Off	Range: FlexLogic™ operand
		↓	
MESSAGE <input type="button" value="▲"/>		Point: 255 Off	Range: FlexLogic™ operand

Up to 256 binary input points can be configured for the DNP or IEC 60870-5-104 protocols. The points are configured by assigning an appropriate FlexLogic™ operand. Refer to the *Introduction to FlexLogic™* section in this chapter for the full range of assignable operands.

The menu for the analog input points (DNP) or MME points (IEC 60870-5-104) is shown below.

PATH: SETTINGS ⇒ PRODUCT SETUP ⇒ COMMUNICATIONS ⇒ DNP / IEC104 POINT LISTS ⇒ ANALOG INPUT / MME POINTS

<input checked="" type="checkbox"/> ANALOG INPUT / MME <input checked="" type="checkbox"/> POINTS	<input type="button" value="◀"/> <input type="button" value="▶"/>	Point: 0 Off	Range: any FlexAnalog parameter
	MESSAGE <input type="button" value="▲"/>	Point: 1 Off	Range: any FlexAnalog parameter
		↓	
MESSAGE <input type="button" value="▲"/>		Point: 255 Off	Range: any FlexAnalog parameter

Up to 256 analog input points can be configured for the DNP or IEC 60870-5-104 protocols. The analog point list is configured by assigning an appropriate FlexAnalog parameter to each point. Refer to Appendix A: *FlexAnalog Parameters* for the full range of assignable parameters.



NOTE

The DNP / IEC 60870-5-104 point lists always begin with point 0 and end at the first “Off” value. Since DNP / IEC 60870-5-104 point lists must be in one continuous block, any points assigned after the first “Off” point are ignored.



NOTE

Changes to the DNP / IEC 60870-5-104 point lists will not take effect until the T60 is restarted.

g) IEC 61850 PROTOCOL

PATH: SETTINGS ⇒ PRODUCT SETUP ⇒ COMMUNICATIONS ⇒ IEC 61850 PROTOCOL ⇒ GSSE / GOOSE CONFIGURATION

<input checked="" type="checkbox"/> GSSE / GOOSE <input checked="" type="checkbox"/> CONFIGURATION	<input type="button" value="◀"/> <input type="button" value="▶"/>	REMOTE I/O TRANSFER METHOD: GSSE	Range: None, GSSE, GOOSE
	MESSAGE <input type="button" value="▲"/>	DEFAULT GSSE/GOOSE: UPDATE TIME: 60 s	Range: 1 to 60 s in steps of 1
MESSAGE <input type="button" value="▲"/>	<input type="button" value="▲"/> <input type="button" value="▼"/>	GOOSE TRANSMIT VLAN PRIORITY: 4	Range: 0 to 7 in steps of 1
MESSAGE <input type="button" value="▲"/>	<input type="button" value="▲"/> <input type="button" value="▼"/>	GOOSE TRANSMIT VLAN ID: 0	Range: 0 to 4095 in steps of 1
MESSAGE <input type="button" value="▲"/>	<input type="button" value="▲"/>	GOOSE TRANSMIT ETYPE APPID: 0	Range: 0 to 16383 in steps of 1

<input type="checkbox"/> SERVER <input checked="" type="checkbox"/> CONFIGURATION		LD NAME: IECDevice	Range: up to 32 alphanumeric characters
MESSAGE		IEC/MMS TCP PORT NUMBER: 102	Range: 1 to 65535 in steps of 1
MESSAGE		INCLUDE NON-IEC DATA: Enabled	Range: Disabled, Enabled
MESSAGE		NUMBER OF STATUS POINTS IN GGIO1: 8	Range: 8 to 128 in steps of 8
MESSAGE		SERVER SCANNING: Disabled	Range: Disabled, Enabled
<input checked="" type="checkbox"/> IEC 61850 LOGICAL <input checked="" type="checkbox"/> NODE NAME PREFIXES		<input checked="" type="checkbox"/> PIOC LOGICAL NODE <input checked="" type="checkbox"/> NAME PREFIXES	
MESSAGE		<input checked="" type="checkbox"/> PTOC LOGICAL NODE <input checked="" type="checkbox"/> NAME PREFIXES	
		↓	
MESSAGE		<input checked="" type="checkbox"/> PTRC LOGICAL NODE <input checked="" type="checkbox"/> NAME PREFIXES	
<input checked="" type="checkbox"/> MMXU DEADBANDS <input type="checkbox"/>		<input checked="" type="checkbox"/> MMXU1 DEADBANDS <input type="checkbox"/>	
MESSAGE		<input checked="" type="checkbox"/> MMXU2 DEADBANDS <input type="checkbox"/>	
MESSAGE		<input checked="" type="checkbox"/> MMXU3 DEADBANDS <input type="checkbox"/>	
MESSAGE		<input checked="" type="checkbox"/> MMXU4 DEADBANDS <input type="checkbox"/>	
<input checked="" type="checkbox"/> GGIO2 CONTROL <input checked="" type="checkbox"/> CONFIGURATION		<input checked="" type="checkbox"/> GGIO2 CF SPCSO 1 <input type="checkbox"/>	
MESSAGE		<input checked="" type="checkbox"/> GGIO2 CF SPCSO 2 <input type="checkbox"/>	
		↓	
MESSAGE		<input checked="" type="checkbox"/> GGIO2 CF SPCSO64 <input type="checkbox"/>	

The IEC 61850 protocol settings are not available if CPU Type 9E is ordered.

NOTE

The T60 supports the Manufacturing Message Specification (MMS) protocol as specified by IEC 61850. MMS is supported over two protocol stacks: TCP/IP over ethernet and TP4/CLNP (OSI) over ethernet. The T60 operates as an IEC 61850 server. The *Remote Inputs/Outputs* section in this chapter describe the peer-to-peer GSSE/GOOSE message scheme.

The **REMOTE I/O TRANSFER METHOD** selects the method used to transfer remote input/output data. This can be either IEC 61850 GSSE, IEC 61850 GOOSE, or none (remote inputs/outputs disabled). GOOSE messages are more efficient and can make use of Ethernet priority tagging and virtual LAN functionality. All relays exchanging remote input/output data must be set to the same transfer method.

The **DEFAULT GSSE/GOOSE UPDATE TIME** sets the time between GSSE or GOOSE messages when there are no remote output state changes to be sent. When remote output data changes, GSSE or GOOSE messages are sent immediately. This setting controls the steady-state 'heartbeat' time interval.

The **GOOSE TRANSMIT VLAN PRIORITY** setting indicates the Ethernet priority of GOOSE messages. This allows GOOSE messages to have higher priority than other Ethernet data. The **GOOSE TRANSMIT ETYPE APPID** setting allows the selection of a specific application ID for each GOOSE sending device. This value can be left at its default if the feature is not required. Both the **GOOSE TRANSMIT VLAN PRIORITY** and **GOOSE TRANSMIT ETYPE APPID** settings are required by IEC 61850.

The **LD NAME** setting represents the MMS domain name (IEC 61850 logical device) where all IEC/MMS logical nodes are located. The **IEC/MMS TCP PORT NUMBER** setting allows the user to change the TCP port number for MMS connections. The **INCLUDE NON-IEC DATA** setting determines whether or not the “UR” MMS domain will be available. This domain contains a large number of UR-series specific data items that are not available in the IEC 61850 logical nodes. This data does not follow the IEC 61850 naming conventions. For communications schemes that strictly follow the IEC 61850 standard, this setting should be “Disabled”.

The **NUMBER OF STATUS POINTS IN GGIO1** setting determines the number of “Ind” (single point status indications) that are instantiated in the GGIO1 logical node. The indication points in GGIO1 are mapped to FlexStates in the T60. These FlexStates allow user-customized access to the FlexLogic™ operand states in the relay.

The **SERVER SCANNING** feature should be set to “Disabled” when IEC 61850 client/server functionality is not required. IEC 61850 has two modes of functionality: GOOSE/GSSE inter-device communication and client/server communication. If the GOOSE/GSSE functionality is required without the IEC 61850 client server feature, then server scanning can be disabled to increase CPU resources. When server scanning is disabled, there will be not updated to the IEC 61850 logical node status values in the T60. Clients will still be able to connect to the server (T60 relay), but most data values will not be updated. This setting does not affect GOOSE/GSSE operation.



Changes to the **LD NAME**, **NUMBER OF STATUS POINTS IN GGIO1**, and **SERVER SCANNING** settings will not take effect until the T60 is restarted.

NOTE

The IEC 61850 logical node name prefix settings are used to create name prefixes to uniquely identify each logical node. For example, the logical node “PTOC1” may have the name prefix “abc”. The full logical node name will then be “abcMMXU1”. Valid characters for the logical node name prefixes are upper and lowercase letters, numbers, and the underscore (_) character, and the first character in the prefix must be a letter. This conforms to the IEC 61850 standard.

The MMXU deadband settings represent the deadband values used to determine when the update the MMXU “mag” and “cVal” values from the associated “instmag” and “instcVal” values. The “mag” and “cVal” values are used for the IEC 61850 buffered and unbuffered reports. These settings correspond to the associated “db” data items in the CF functional constraint of the MMXU logical node, as per the IEC 61850 standard. According to IEC 61850-7-3, the db value “shall represent the percentage of difference between the max and min in units of 0.00%”. Thus, it is important to know the maximum value for each MMXU measured quantity, since this represents the 100.00% value for the deadband. The minimum value for all quantities is 0; the maximum values are as follows:

phase current: $46 \times$ phase CT primary setting
 neutral current: $46 \times$ ground CT primary setting
 voltage: $275 \times$ VT ratio setting
 power (real, reactive, and apparent): $46 \times$ phase CT primary setting \times $275 \times$ VT ratio setting
 frequency: 90 Hz
 power factor: 2

The GGIO2 control configuration settings are used to set the control model for each input. The available choices are “0” (status only), “1” (direct control), and “2” (SBO with normal security). The GGIO2 control points are used to control the T60 virtual inputs.



Since GSSE/GOOSE messages are multicast ethernet by specification, they will not usually be forwarded by network routers. However, GOOSE messages may be forwarded by routers if the router has been configured for VLAN functionality.

NOTE

h) WEB SERVER HTTP PROTOCOL

PATH: SETTINGS \Rightarrow PRODUCT SETUP \Rightarrow COMMUNICATIONS \Rightarrow WEB SERVER HTTP PROTOCOL

<input checked="" type="checkbox"/> WEB SERVER <input checked="" type="checkbox"/> HTTP PROTOCOL	<input type="button" value="◀"/> <input type="button" value="▶"/>	HTTP TCP PORT NUMBER: 80	<i>Range: 1 to 65535 in steps of 1</i>
---	---	-----------------------------	--

The T60 contains an embedded web server and is capable of transferring web pages to a web browser such as Microsoft Internet Explorer or Netscape Navigator. This feature is available only if the T60 has the ethernet option installed. The web pages are organized as a series of menus that can be accessed starting at the T60 “Main Menu”. Web pages are available

showing DNP and IEC 60870-5-104 points lists, Modbus registers, Event Records, Fault Reports, etc. The web pages can be accessed by connecting the UR and a computer to an ethernet network. The Main Menu will be displayed in the web browser on the computer simply by entering the IP address of the T60 into the “Address” box on the web browser.

i) TFTP PROTOCOL

PATH: SETTINGS ⇒ PRODUCT SETUP ⇒ COMMUNICATIONS ⇒ TFTP PROTOCOL

<input checked="" type="checkbox"/> TFTP PROTOCOL <input type="checkbox"/>		TFTP MAIN UDP PORT NUMBER: 69	Range: 1 to 65535 in steps of 1
	MESSAGE	TFTP DATA UDP PORT 1 NUMBER: 0	Range: 0 to 65535 in steps of 1
	MESSAGE	TFTP DATA UDP PORT 2 NUMBER: 0	Range: 0 to 65535 in steps of 1

The Trivial File Transfer Protocol (TFTP) can be used to transfer files from the T60 over a network. The T60 operates as a TFTP server. TFTP client software is available from various sources, including Microsoft Windows NT. The `dir.txt` file obtained from the T60 contains a list and description of all available files (event records, oscillography, etc.).

j) IEC 60870-5-104 PROTOCOL

PATH: SETTINGS ⇒ PRODUCT SETUP ⇒ COMMUNICATIONS ⇒ IEC 60870-5-104 PROTOCOL

<input checked="" type="checkbox"/> IEC 60870-5-104 <input checked="" type="checkbox"/> PROTOCOL		IEC 60870-5-104 FUNCTION: Disabled	Range: Enabled, Disabled
	MESSAGE	IEC TCP PORT NUMBER: 2404	Range: 1 to 65535 in steps of 1
MESSAGE	<input checked="" type="checkbox"/> IEC NETWORK <input checked="" type="checkbox"/> CLIENT ADDRESSES		
MESSAGE	IEC COMMON ADDRESS OF ASDU: 0	Range: 0 to 65535 in steps of 1	
MESSAGE	IEC CYCLIC DATA PERIOD: 60 s	Range: 1 to 65535 s in steps of 1	
MESSAGE	IEC CURRENT DEFAULT THRESHOLD: 30000	Range: 0 to 65535 in steps of 1	
MESSAGE	IEC VOLTAGE DEFAULT THRESHOLD: 30000	Range: 0 to 65535 in steps of 1	
MESSAGE	IEC POWER DEFAULT THRESHOLD: 30000	Range: 0 to 65535 in steps of 1	
MESSAGE	IEC ENERGY DEFAULT THRESHOLD: 30000	Range: 0 to 65535 in steps of 1	
MESSAGE	IEC OTHER DEFAULT THRESHOLD: 30000	Range: 0 to 65535 in steps of 1	

The T60 supports the IEC 60870-5-104 protocol. The T60 can be used as an IEC 60870-5-104 slave device connected to a maximum of two masters (usually either an RTU or a SCADA master station). Since the T60 maintains two sets of IEC 60870-5-104 data change buffers, no more than two masters should actively communicate with the T60 at one time.

The IEC ----- **DEFAULT THRESHOLD** settings are used to determine when to trigger spontaneous responses containing M_ME_NC_1 analog data. These settings group the T60 analog data into types: current, voltage, power, energy, and other. Each setting represents the default threshold value for all M_ME_NC_1 analog points of that type. For example, to trigger spontaneous responses from the T60 when any current values change by 15 A, the **IEC CURRENT DEFAULT THRESHOLD** setting should be set to 15. Note that these settings are the default values of the deadbands. P_ME_NC_1 (parameter of measured value, short floating point value) points can be used to change threshold values, from the default, for each individual M_ME_NC_1 analog point. Whenever power is removed and re-applied to the T60, the default thresholds will be in effect.



The IEC 60870-5-104 and DNP protocols can not be used at the same time. When the IEC 60870-5-104 FUNCTION setting is set to “Enabled”, the DNP protocol will not be operational. When this setting is changed it will not become active until power to the relay has been cycled (Off/On).

k) SNTP PROTOCOL

PATH: SETTINGS ⇒ PRODUCT SETUP ⇒ COMMUNICATIONS ⇒ SNTP PROTOCOL

<input type="checkbox"/> SNTP PROTOCOL	◀▶	SNTP FUNCTION: Disabled	Range: Enabled, Disabled
MESSAGE	▲▼	SNTP SERVER IP ADDR: 0.0.0.0	Range: Standard IP address format
MESSAGE	▲	SNTP UDP PORT NUMBER: 123	Range: 0 to 65535 in steps of 1

The T60 supports the Simple Network Time Protocol specified in RFC-2030. With SNTP, the T60 can obtain clock time over an Ethernet network. The T60 acts as an SNTP client to receive time values from an SNTP/NTP server, usually a dedicated product using a GPS receiver to provide an accurate time. Both unicast and broadcast SNTP are supported.

If SNTP functionality is enabled at the same time as IRIG-B, the IRIG-B signal provides the time value to the T60 clock for as long as a valid signal is present. If the IRIG-B signal is removed, the time obtained from the SNTP server is used. If either SNTP or IRIG-B is enabled, the T60 clock value cannot be changed using the front panel keypad.

To use SNTP in unicast mode, **SNTP SERVER IP ADDR** must be set to the SNTP/NTP server IP address. Once this address is set and **SNTP FUNCTION** is “Enabled”, the T60 attempts to obtain time values from the SNTP/NTP server. Since many time values are obtained and averaged, it generally takes three to four minutes until the T60 clock is closely synchronized with the SNTP/NTP server. It may take up to two minutes for the T60 to signal an SNTP self-test error if the server is offline.

To use SNTP in broadcast mode, set the **SNTP SERVER IP ADDR** setting to “0.0.0.0” and **SNTP FUNCTION** to “Enabled”. The T60 then listens to SNTP messages sent to the “all ones” broadcast address for the subnet. The T60 waits up to eighteen minutes (>1024 seconds) without receiving an SNTP broadcast message before signaling an SNTP self-test error.

The UR-series relays do not support the multicast or anycast SNTP functionality.

l) EGD PROTOCOL

PATH: SETTINGS ⇒ PRODUCT SETUP ⇒ COMMUNICATIONS ⇒ EGD PROTOCOL

<input type="checkbox"/> EGD PROTOCOL	◀▶	<input type="checkbox"/> FAST PROD EXCH 1 <input type="checkbox"/> CONFIGURATION
MESSAGE	▲▼	<input type="checkbox"/> SLOW PROD EXCH 1 <input type="checkbox"/> CONFIGURATION
MESSAGE	▲	<input type="checkbox"/> SLOW PROD EXCH 2 <input type="checkbox"/> CONFIGURATION



The Ethernet Global Data (EGD) protocol settings are not available if CPU Type 9E is ordered.

The relay supports one fast Ethernet Global Data (EGD) exchange and two slow EGD exchanges. There are 20 data items in the fast-produced EGD exchange and 50 data items in each slow-produced exchange.

Ethernet Global Data (EGD) is a suite of protocols used for the real-time transfer of data for display and control purposes. The relay can be configured to ‘produce’ EGD data exchanges, and other devices can be configured to ‘consume’ EGD data exchanges. The number of produced exchanges (up to three), the data items in each exchange (up to 50), and the exchange production rate can be configured.

EGD cannot be used to transfer data between UR-series relays. The relay supports EGD production only. An EGD exchange will not be transmitted unless the destination address is non-zero, and at least the first data item address is set to a valid Modbus register address. Note that the default setting value of “0” is considered invalid.

The settings menu for the fast EGD exchange is shown below:

PATH: SETTINGS ⇒ PRODUCT SETUP ⇒ COMMUNICATIONS ⇒ EGD PROTOCOL ⇒ FAST PROD EXCH 1 CONFIGURATION

■ FAST PROD EXCH 1 ■ CONFIGURATION	◀▶	EXCH 1 FUNCTION: Disable	Range: Disable, Enable
MESSAGE	▲▼	EXCH 1 DESTINATION: 0.0.0.0	Range: standard IP address
MESSAGE	▲▼	EXCH 1 DATA RATE: 1000 ms	Range: 50 to 1000 ms in steps of 1
MESSAGE	▲▼	EXCH 1 DATA ITEM 1: 0	Range: 0 to 65535 in steps of 1 (Modbus register address range)
		↓	
MESSAGE	▲	EXCH 1 DATA ITEM 20: 0	Range: 0 to 65535 in steps of 1 (Modbus register address range)

Fast exchanges (50 to 1000 ms) are generally used in control schemes. The T60 has one fast exchange (Exchange 1) and two slow exchanges (Exchanges 2 and 3).

The settings menu for the slow EGD exchanges is shown below:

PATH: SETTINGS ⇒ PRODUCT SETUP ⇒ COMMUNICATIONS ⇒ EGD PROTOCOL ⇒ SLOW PROD EXCH 1(2) CONFIGURATION

■ SLOW PROD EXCH 1 ■ CONFIGURATION	◀▶	EXCH 1 FUNCTION: Disable	Range: Disable, Enable
MESSAGE	▲▼	EXCH 1 DESTINATION: 0.0.0.0	Range: standard IP address
MESSAGE	▲▼	EXCH 1 DATA RATE: 1000 ms	Range: 500 to 1000 ms in steps of 1
MESSAGE	▲▼	EXCH 1 DATA ITEM 1: 0	Range: 0 to 65535 in steps of 1 (Modbus register address range in decimal)
		↓	
MESSAGE	▲	EXCH 1 DATA ITEM 50: 0	Range: 0 to 65535 in steps of 1 (Modbus register address range in decimal)



Slow EGD exchanges (500 to 1000 ms) are generally used for the transfer and display of data items. The settings for the fast and slow exchanges are described below:

- **EXCH 1 DESTINATION:** This setting specifies the destination IP address of the produced EGD exchange. This is usually unicast or broadcast.
- **EXCH 1 DATA RATE:** This setting specifies the rate at which this EGD exchange is transmitted. If the setting is 50 ms, the exchange data will be updated and sent once every 50 ms. If the setting is 1000 ms, the exchange data will be updated and sent once per second. EGD exchange 1 has a setting range of 50 to 1000 ms. Exchanges 2 and 3 have a setting range of 500 to 1000 ms.
- **EXCH 1 DATA ITEM 1 to 20/50:** These settings specify the data items that are part of this EGD exchange. Almost any data from the T60 memory map can be configured to be included in an EGD exchange. The settings are the starting Modbus register address for the data item in decimal format. Refer to Appendix B for the complete Modbus memory map. Note that the Modbus memory map displays shows addresses in hexadecimal format; as such, it will be necessary to convert these values to decimal format before entering them as values for these setpoints.

To select a data item to be part of an exchange, it is only necessary to choose the starting Modbus address of the item. That is, for items occupying more than one Modbus register (e.g. 32 bit integers and floating point values), only the first Modbus address is required. The EGD exchange configured with these settings contains the data items up to the first setting that contains a Modbus address with no data, or 0. That is, if the first three settings contain valid Modbus addresses and the fourth is 0, the produced EGD exchange will contain three data items.

5.2.5 MODBUS USER MAP



PATH: SETTINGS ⇒ PRODUCT SETUP ⇒ MODBUS USER MAP

<input type="checkbox"/> MODBUS USER MAP <input type="checkbox"/>	 	ADDRESS 1: 0	Range: 0 to 65535 in steps of 1
		VALUE: 0	
		↓	
MESSAGE		ADDRESS 256: 0	Range: 0 to 65535 in steps of 1
		VALUE: 0	

The Modbus User Map provides read-only access for up to 256 registers. To obtain a memory map value, enter the desired address in the **ADDRESS** line (this value must be converted from hex to decimal format). The corresponding value is displayed in the **VALUE** line. A value of "0" in subsequent register **ADDRESS** lines automatically returns values for the previous **ADDRESS** lines incremented by "1". An address value of "0" in the initial register means "none" and values of "0" will be displayed for all registers. Different **ADDRESS** values can be entered as required in any of the register positions.

5.2.6 REAL TIME CLOCK

PATH: SETTINGS ⇒ PRODUCT SETUP ⇒ REAL TIME CLOCK











<input type="checkbox"/> REAL TIME <input type="checkbox"/> CLOCK	 	IRIG-B SIGNAL TYPE:	Range: None, DC Shift, Amplitude Modulated
		None	
MESSAGE		REAL TIME CLOCK	Range: Disabled, Enabled
		EVENTS: Disabled	

The date and time can be synchronized a known time base and to other relays using an IRIG-B signal. It has the same accuracy as an electronic watch, approximately ± 1 minute per month. If an IRIG-B signal is connected to the relay, only the current year needs to be entered. See the **COMMANDS** ⇒ SET DATE AND TIME menu to manually set the relay clock.

The **REAL TIME CLOCK EVENTS** setting allows changes to the date and/or time to be captured in the event record.

5.2.7 USER-PROGRAMMABLE FAULT REPORT

PATH: SETTINGS ⇒ PRODUCT SETUP ⇒ USER-PROGRAMMABLE FAULT REPORT ⇒ USER-PROGRAMMABLE FAULT REPORT 1(2)

<input type="checkbox"/> USER-PROGRAMMABLE <input type="checkbox"/> FAULT REPORT 1	 	FAULT REPORT 1	Range: Disabled, Enabled
		FUNCTION: Disabled	
MESSAGE		PRE-FAULT 1 TRIGGER:	Range: FlexLogic™ operand
		Off	
MESSAGE		FAULT 1 TRIGGER:	Range: FlexLogic™ operand
		Off	
MESSAGE		FAULT REPORT 1 #1:	Range: Off, any actual value analog parameter
		Off	
MESSAGE		FAULT REPORT 1 #2:	Range: Off, any actual value analog parameter
		Off	
		↓	
MESSAGE		FAULT REPORT 1 #32:	Range: Off, any actual value analog parameter
		Off	

When enabled, this function monitors the pre-fault trigger. The pre-fault data are stored in the memory for prospective creation of the fault report on the rising edge of the pre-fault trigger. The element waits for the fault trigger as long as the pre-fault trigger is asserted, but not shorter than 1 second. When the fault trigger occurs, the fault data is stored and the complete report is created. If the fault trigger does not occur within 1 second after the pre-fault trigger drops out, the element resets and no record is created.

The user programmable record contains the following information: the user-programmed relay name, detailed firmware revision (4.8x, for example) and relay model (T60), the date and time of trigger, the name of pre-fault trigger (specific FlexLogic™ operand), the name of fault trigger (specific FlexLogic™ operand), the active setting group at pre-fault trigger, the active setting group at fault trigger, pre-fault values of all programmed analog channels (one cycle before pre-fault trigger), and fault values of all programmed analog channels (at the fault trigger).

The report includes fault duration times for each of the breakers (created by the Breaker Arcing Current feature). To include fault duration times in the fault report, the user must enable and configure Breaker Arcing Current feature for each of the breakers. Fault duration is reported on a per-phase basis.

Each fault report is stored as a file to a maximum capacity of ten files. An eleventh trigger overwrites the oldest file. The EnerVista UR Setup software is required to view all captured data. A FAULT RPT TRIG event is automatically created when the report is triggered.

The relay includes two user-programmable fault reports to enable capture of two types of trips (for example, trip from thermal protection with the report configured to include temperatures, and short-circuit trip with the report configured to include voltages and currents). Both reports feed the same report file queue.

The last record is available as individual data items via communications protocols.

- **PRE-FAULT 1 TRIGGER:** Specifies the FlexLogic™ operand to capture the pre-fault data. The rising edge of this operand stores one cycle-old data for subsequent reporting. The element waits for the fault trigger to actually create a record as long as the operand selected as **PRE-FAULT TRIGGER** is “On”. If the operand remains “Off” for 1 second, the element resets and no record is created.
- **FAULT 1 TRIGGER:** Specifies the FlexLogic™ operand to capture the fault data. The rising edge of this operand stores the data as fault data and results in a new report. The trigger (not the pre-fault trigger) controls the date and time of the report.
- **FAULT REPORT 1 #1 to #32:** These settings specify an actual value such as voltage or current magnitude, true RMS, phase angle, frequency, temperature, etc., to be stored should the report be created. Up to 32 channels can be configured. Two reports are configurable to cope with variety of trip conditions and items of interest.

5.2.8 OSCILLOGRAPHY

a) MAIN MENU

PATH: SETTINGS ⇒ PRODUCT SETUP ⇄ OSCILLOGRAPHY

■ OSCILLOGRAPHY	◀▶	NUMBER OF RECORDS: 15	Range: 1 to 64 in steps of 1
MESSAGE	▲▼	TRIGGER MODE: Automatic Overwrite	Range: Automatic Overwrite, Protected
MESSAGE	▲▼	TRIGGER POSITION: 50%	Range: 0 to 100% in steps of 1
MESSAGE	▲▼	TRIGGER SOURCE: Off	Range: FlexLogic™ operand
MESSAGE	▲▼	AC INPUT WAVEFORMS: 16 samples/cycle	Range: Off, 8, 16, 32, 64 samples/cycle
MESSAGE	▲▼	■ DIGITAL CHANNELS ■	
MESSAGE	▲	■ ANALOG CHANNELS ■	

Oscillography records contain waveforms captured at the sampling rate as well as other relay data at the point of trigger. Oscillography records are triggered by a programmable FlexLogic™ operand. Multiple oscillography records may be captured simultaneously.

The **NUMBER OF RECORDS** is selectable, but the number of cycles captured in a single record varies considerably based on other factors such as sample rate and the number of operational CT/VT modules. There is a fixed amount of data storage for oscillography; the more data captured, the less the number of cycles captured per record. See the **ACTUAL VALUES** ⇨⇩ **RECORDS** ⇨⇩ **OSCILLOGRAPHY** menu to view the number of cycles captured per record. The following table provides sample configurations with corresponding cycles/record.

Table 5–1: OSCILLOGRAPHY CYCLES/RECORD EXAMPLE

# RECORDS	# CT/VTS	SAMPLE RATE	# DIGITALS	# ANALOGS	CYCLES/RECORD
1	1	8	0	0	1872.0
1	1	16	16	0	1685.0
8	1	16	16	0	276.0
8	1	16	16	4	219.5
8	2	16	16	4	93.5
8	2	16	64	16	93.5
8	2	32	64	16	57.6
8	2	64	64	16	32.3
32	2	64	64	16	9.5

A new record may automatically overwrite an older record if **TRIGGER MODE** is set to “Automatic Overwrite”.

Set the **TRIGGER POSITION** to a percentage of the total buffer size (e.g. 10%, 50%, 75%, etc.). A trigger position of 25% consists of 25% pre- and 75% post-trigger data. The **TRIGGER SOURCE** is always captured in oscillography and may be any FlexLogic™ parameter (element state, contact input, virtual output, etc.). The relay sampling rate is 64 samples per cycle.

The **AC INPUT WAVEFORMS** setting determines the sampling rate at which AC input signals (i.e. current and voltage) are stored. Reducing the sampling rate allows longer records to be stored. This setting has no effect on the internal sampling rate of the relay which is always 64 samples per cycle, i.e. it has no effect on the fundamental calculations of the device.

 **When changes are made to the oscillography settings, all existing oscillography records will be CLEARED.**

b) DIGITAL CHANNELS

PATH: SETTINGS ⇨ PRODUCT SETUP ⇨⇩ OSCILLOGRAPHY ⇨⇩ DIGITAL CHANNELS

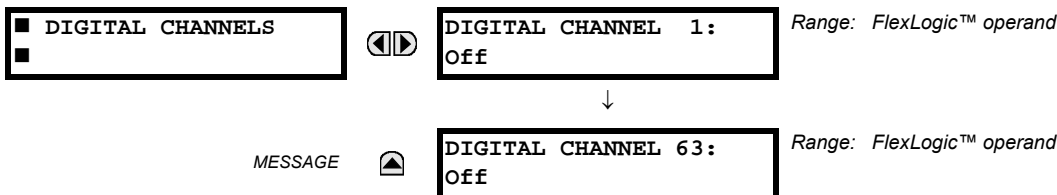

A **DIGITAL CHANNEL** setting selects the FlexLogic™ operand state recorded in an oscillography trace. The length of each oscillography trace depends in part on the number of parameters selected here. Parameters set to “Off” are ignored. Upon startup, the relay will automatically prepare the parameter list.

c) ANALOG CHANNELS

PATH: SETTINGS ⇨ PRODUCT SETUP ⇨⇩ OSCILLOGRAPHY ⇨⇩ ANALOG CHANNELS

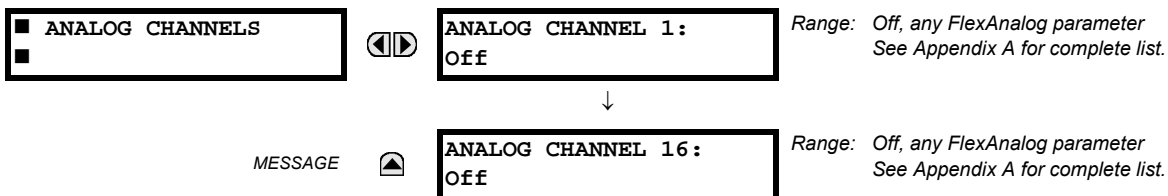

An **ANALOG CHANNEL** setting selects the metering actual value recorded in an oscillography trace. The length of each oscillography trace depends in part on the number of parameters selected here. Parameters set to “Off” are ignored. The parameters available in a given relay are dependent on: (a) the type of relay, (b) the type and number of CT/VT hardware modules installed, and (c) the type and number of Analog Input hardware modules installed. Upon startup, the relay will automatically prepare the parameter list. A list of all possible analog metering actual value parameters is presented in Appendix A: *FlexAnalog Parameters*. The parameter index number shown in any of the tables is used to expedite the selection of the parameter on the relay display. It can be quite time-consuming to scan through the list of parameters via the relay keypad/display - entering this number via the relay keypad will cause the corresponding parameter to be displayed.

All eight CT/VT module channels are stored in the oscillography file. The CT/VT module channels are named as follows:

`<slot_letter><terminal_number>—<I or V><phase A, B, or C, or 4th input>`

The fourth current input in a bank is called IG, and the fourth voltage input in a bank is called VX. For example, F2-IB designates the IB signal on Terminal 2 of the CT/VT module in slot F. If there are no CT/VT modules and Analog Input modules, no analog traces will appear in the file; only the digital traces will appear.



The source harmonic indices appear as oscillography analog channels numbered from 0 to 23. These correspond directly to the 2nd to 25th harmonics in the relay as follows:

Analog channel 0 ↔ 2nd harmonic
 Analog channel 1 ↔ 3rd harmonic
 ...
 Analog channel 23 ↔ 25th harmonic

5.2.9 DATA LOGGER

PATH: SETTINGS ⇌⇌ PRODUCT SETUP ⇌⇌ DATA LOGGER

■ DATA LOGGER	◀▶	DATA LOGGER MODE: Continuous	Range: Continuous, Trigger
MESSAGE	▲▼	DATA LOGGER TRIGGER: Off	Range: FlexLogic™ operand
MESSAGE	▲▼	DATA LOGGER RATE: 60000 ms	Range: 15 to 3600000 ms in steps of 1
MESSAGE	▲▼	DATA LOGGER CHNL 1: Off	Range: Off, any FlexAnalog parameter. See Appendix A: FlexAnalog Parameters for complete list.
MESSAGE	▲▼	DATA LOGGER CHNL 2: Off	Range: Off, any FlexAnalog parameter. See Appendix A: FlexAnalog Parameters for complete list.
↓			
MESSAGE	▲▼	DATA LOGGER CHNL 16: Off	Range: Off, any FlexAnalog parameter. See Appendix A: FlexAnalog Parameters for complete list.
MESSAGE	▲	DATA LOGGER CONFIG: 0 CHNL x 0.0 DAYS	Range: Not applicable - shows computed data only

The data logger samples and records up to 16 analog parameters at a user-defined sampling rate. This recorded data may be downloaded to EnerVista UR Setup and displayed with *parameters* on the vertical axis and *time* on the horizontal axis. All data is stored in non-volatile memory, meaning that the information is retained when power to the relay is lost.

For a fixed sampling rate, the data logger can be configured with a few channels over a long period or a larger number of channels for a shorter period. The relay automatically partitions the available memory between the channels in use. Example storage capacities for a system frequency of 60 Hz are shown in the following table.

Table 5–2: DATA LOGGER STORAGE CAPACITY EXAMPLE

SAMPLING RATE	CHANNELS	DAYS	STORAGE CAPACITY
15 ms	1	0.1	1119 s
	8	0.1	140 s
	9	0.1	124 s
	16	0.1	70 s
1000 ms	1	0.7	65658 s
	8	0.1	8207 s
	9	0.1	7295 s
	16	0.1	4104 s
60000 ms	1	45.4	3931397 s
	8	5.6	491425 s
	9	5	436822 s
	16	2.8	245712 s
3600000 ms	1	2727.5	235875737 s
	8	340.9	29484467 s
	9	303	26208415 s



Changing any setting affecting Data Logger operation will clear any data that is currently in the log.

NOTE

- **DATA LOGGER MODE:** This setting configures the mode in which the data logger will operate. When set to “Continuous”, the data logger will actively record any configured channels at the rate as defined by the **DATA LOGGER RATE**. The

data logger will be idle in this mode if no channels are configured. When set to "Trigger", the data logger will begin to record any configured channels at the instance of the rising edge of the **DATA LOGGER TRIGGER** source FlexLogic™ operand. The **Data Logger will ignore** all subsequent triggers and will continue to record data until the active record is full. Once the data logger is full a **CLEAR DATA LOGGER** command is required to clear the data logger record before a new record can be started. Performing the **CLEAR DATA LOGGER** command will also stop the current record and reset the data logger to be ready for the next trigger.

- **DATA LOGGER TRIGGER:** This setting selects the signal used to trigger the start of a new data logger record. Any FlexLogic™ operand can be used as the trigger source. The **DATA LOGGER TRIGGER** setting only applies when the mode is set to "Trigger".
- **DATA LOGGER RATE:** This setting selects the time interval at which the actual value data will be recorded.
- **DATA LOGGER CHNL 1(16):** This setting selects the metering actual value that is to be recorded in Channel 1(16) of the data log. The parameters available in a given relay are dependent on: the type of relay, the type and number of CT/VT hardware modules installed, and the type and number of Analog Input hardware modules installed. Upon startup, the relay will automatically prepare the parameter list. A list of all possible analog metering actual value parameters is shown in Appendix A: *FlexAnalog Parameters*. The parameter index number shown in any of the tables is used to expedite the selection of the parameter on the relay display. It can be quite time-consuming to scan through the list of parameters via the relay keypad/display – entering this number via the relay keypad will cause the corresponding parameter to be displayed.
- **DATA LOGGER CONFIG:** This display presents the total amount of time the Data Logger can record the channels not selected to "Off" without over-writing old data.

5.2.10 DEMAND

PATH: SETTINGS ⇨ PRODUCT SETUP ⇨ DEMAND

■ DEMAND	◀▶	CRNT DEMAND METHOD: Thermal Exponential	Range: Thermal Exponential, Block Interval, Rolling Demand
MESSAGE	▲▼	POWER DEMAND METHOD: Thermal Exponential	Range: Thermal Exponential, Block Interval, Rolling Demand
MESSAGE	▲▼	DEMAND INTERVAL: 15 MIN	Range: 5, 10, 15, 20, 30, 60 minutes
MESSAGE	▲	DEMAND TRIGGER: Off	Range: FlexLogic™ operand Note: for calculation using Method 2a

The relay measures current demand on each phase, and three-phase demand for real, reactive, and apparent power. Current and Power methods can be chosen separately for the convenience of the user. Settings are provided to allow the user to emulate some common electrical utility demand measuring techniques, for statistical or control purposes. If the **CRNT DEMAND METHOD** is set to "Block Interval" and the **DEMAND TRIGGER** is set to "Off", Method 2 is used (see below). If **DEMAND TRIGGER** is assigned to any other FlexLogic™ operand, Method 2a is used (see below).

The relay can be set to calculate demand by any of three methods as described below:

CALCULATION METHOD 1: THERMAL EXPONENTIAL

This method emulates the action of an analog peak recording thermal demand meter. The relay measures the quantity (RMS current, real power, reactive power, or apparent power) on each phase every second, and assumes the circuit quantity remains at this value until updated by the next measurement. It calculates the 'thermal demand equivalent' based on the following equation:

$$d(t) = D(1 - e^{-kt}) \quad (\text{EQ 5.6})$$

where: d = demand value after applying input quantity for time t (in minutes)
 D = input quantity (constant), and $k = 2.3 / \text{thermal } 90\% \text{ response time}$.

The 90% thermal response time characteristic of 15 minutes is illustrated below. A setpoint establishes the time to reach 90% of a steady-state value, just as the response time of an analog instrument. A steady state value applied for twice the response time will indicate 99% of the value.

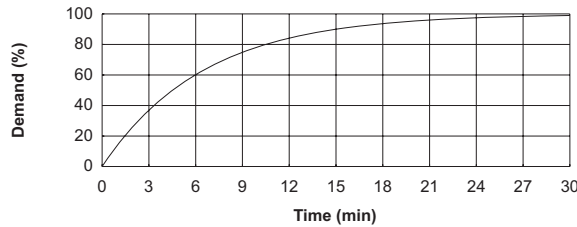

Figure 5-2: THERMAL DEMAND CHARACTERISTIC

CALCULATION METHOD 2: BLOCK INTERVAL

This method calculates a linear average of the quantity (RMS current, real power, reactive power, or apparent power) over the programmed demand time interval, starting daily at 00:00:00 (i.e. 12:00 am). The 1440 minutes per day is divided into the number of blocks as set by the programmed time interval. Each new value of demand becomes available at the end of each time interval.

CALCULATION METHOD 2a: BLOCK INTERVAL (with Start Demand Interval Logic Trigger)

This method calculates a linear average of the quantity (RMS current, real power, reactive power, or apparent power) over the interval between successive Start Demand Interval logic input pulses. Each new value of demand becomes available at the end of each pulse. Assign a FlexLogic™ operand to the DEMAND TRIGGER setting to program the input for the new demand interval pulses.

NOTE If no trigger is assigned in the DEMAND TRIGGER setting and the CRNT DEMAND METHOD is "Block Interval", use calculating method #2. If a trigger is assigned, the maximum allowed time between 2 trigger signals is 60 minutes. If no trigger signal appears within 60 minutes, demand calculations are performed and available and the algorithm resets and starts the new cycle of calculations. The minimum required time for trigger contact closure is 20 μs.

CALCULATION METHOD 3: ROLLING DEMAND

This method calculates a linear average of the quantity (RMS current, real power, reactive power, or apparent power) over the programmed demand time interval, in the same way as Block Interval. The value is updated every minute and indicates the demand over the time interval just preceding the time of update.

5.2.11 USER-PROGRAMMABLE LEADS

a) MAIN MENU

PATH: SETTINGS ⇒ PRODUCT SETUP ⇒ USER-PROGRAMMABLE LEADS

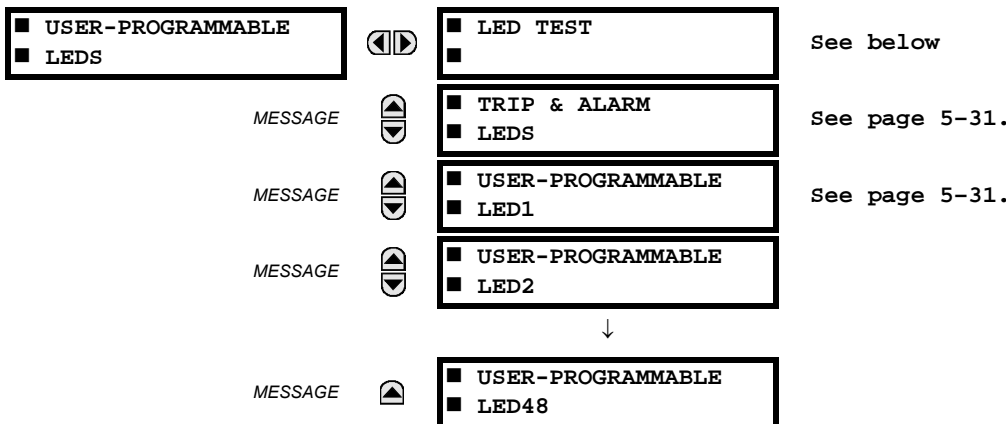

b) LED TEST

PATH: SETTINGS ⇒ PRODUCT SETUP ⇒ USER-PROGRAMMABLE LEDES ⇒ LED TEST

<div style="border: 1px solid black; padding: 2px;"> <div style="display: flex; align-items: center;"> <div style="width: 15px; height: 15px; background-color: black; margin-right: 5px;"></div> LED TEST </div> <div style="border-top: 1px solid black; height: 15px; margin-top: 5px;"></div> </div>	<div style="display: flex; align-items: center; justify-content: center;"> <div style="width: 15px; height: 15px; border: 1px solid black; border-radius: 50%; margin-right: 5px; display: flex; align-items: center; justify-content: center;"> <div style="width: 5px; height: 5px; background-color: black; margin-right: 2px;"></div> <div style="width: 5px; height: 5px; background-color: black; margin-right: 2px;"></div> </div> </div>	<div style="border: 1px solid black; padding: 2px;"> <div style="display: flex; align-items: center;"> <div style="width: 150px; border-bottom: 1px solid black; margin-bottom: 2px;"></div> <div style="margin-left: 5px;">LED TEST FUNCTION:</div> </div> <div style="margin-left: 5px;">Disabled</div> </div>	<i>Range: Disabled, Enabled.</i>
<div style="display: flex; align-items: center; justify-content: center;"> <div style="width: 15px; height: 15px; border: 1px solid black; border-radius: 50%; margin-right: 5px; display: flex; align-items: center; justify-content: center;"> <div style="width: 5px; height: 5px; background-color: black; margin-right: 2px;"></div> </div> </div>	<div style="border: 1px solid black; padding: 2px;"> <div style="display: flex; align-items: center;"> <div style="width: 150px; border-bottom: 1px solid black; margin-bottom: 2px;"></div> <div style="margin-left: 5px;">LED TEST CONTROL:</div> </div> <div style="margin-left: 5px;">Off</div> </div>	<i>Range: FlexLogic™ operand</i>	

When enabled, the LED Test can be initiated from any digital input or user-programmable condition such as user-programmable pushbutton. The control operand is configured under the **LED TEST CONTROL** setting. The test covers all LEDs, including the LEDs of the optional user-programmable pushbuttons.

The test consists of three stages.

Stage 1: All 62 LEDs on the relay are illuminated. This is a quick test to verify if any of the LEDs is “burned”. This stage lasts as long as the control input is on, up to a maximum of 1 minute. After 1 minute, the test will end.

Stage 2: All the LEDs are turned off, and then one LED at a time turns on for 1 second, then back off. The test routine starts at the top left panel, moving from the top to bottom of each LED column. This test checks for hardware failures that lead to more than one LED being turned on from a single logic point. This stage can be interrupted at any time.

Stage 3: All the LEDs are turned on. One LED at a time turns off for 1 second, then back on. The test routine starts at the top left panel moving from top to bottom of each column of the LEDs. This test checks for hardware failures that lead to more than one LED being turned off from a single logic point. This stage can be interrupted at any time.

When testing is in progress, the LEDs are controlled by the test sequence, rather than the protection, control, and monitoring features. However, the LED control mechanism accepts all the changes to LED states generated by the relay and stores the actual LED states (On or Off) in memory. When the test completes, the LEDs reflect the actual state resulting from relay response during testing. The Reset pushbutton will not clear any targets when the LED Test is in progress.

A dedicated FlexLogic™ operand, LED TEST IN PROGRESS, is set for the duration of the test. When the test sequence is initiated, the LED Test Initiated event is stored in the Event Recorder.

The entire test procedure is user-controlled. In particular, Stage 1 can last as long as necessary, and Stages 2 and 3 can be interrupted. The test responds to the position and rising edges of the control input defined by the **LED TEST CONTROL** setting. The control pulses must last at least 250 ms to take effect. The following diagram explains how the test is executed.

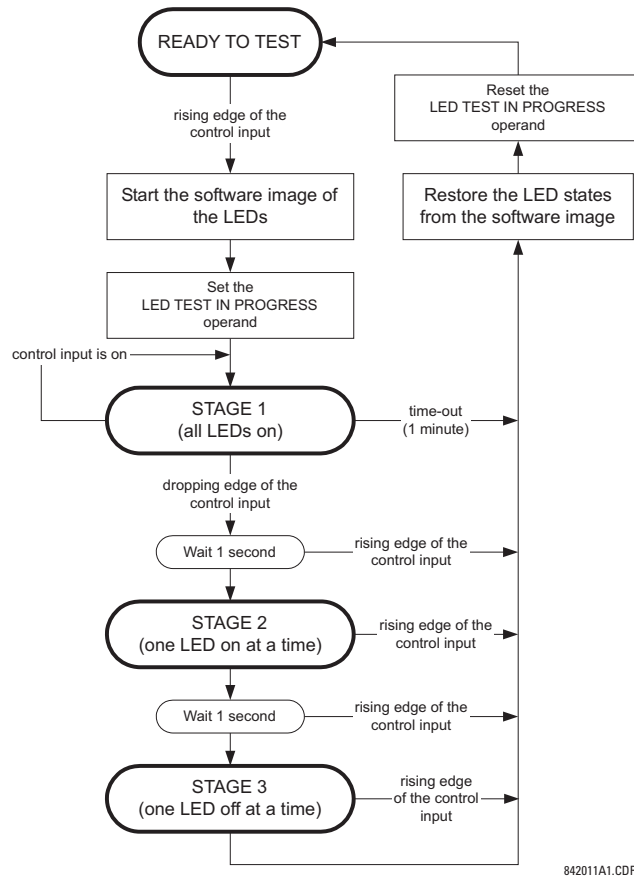

842011A1.CDR

Figure 5–3: LED TEST SEQUENCE

APPLICATION EXAMPLE 1:

Assume one needs to check if any of the LEDs is “burned” through User-Programmable Pushbutton 1. The following settings should be applied. Configure User-Programmable Pushbutton 1 by making the following entries in the **SETTINGS** ⇒ **PRODUCT SETUP** ⇒ **USER-PROGRAMMABLE PUSHBUTTONS** ⇒ **USER PUSHBUTTON 1** menu:

PUSHBUTTON 1 FUNCTION: “Self-reset”

PUSHBTN 1 DROP-OUT TIME: “0.10 s”

Configure the LED test to recognize User-Programmable Pushbutton 1 by making the following entries in the **SETTINGS** ⇒ **PRODUCT SETUP** ⇒ **USER-PROGRAMMABLE LEDES** ⇒ **LED TEST** menu:

LED TEST FUNCTION: “Enabled”

LED TEST CONTROL: “PUSHBUTTON 1 ON”

The test will be initiated when the User-Programmable Pushbutton 1 is pressed. The pushbutton should remain pressed for as long as the LEDs are being visually inspected. When finished, the pushbutton should be released. The relay will then automatically start Stage 2. At this point forward, test may be aborted by pressing the pushbutton.

APPLICATION EXAMPLE 2:

Assume one needs to check if any LEDs are “burned” as well as exercise one LED at a time to check for other failures. This is to be performed via User-Programmable Pushbutton 1.

After applying the settings in Application Example 1, hold down the pushbutton as long as necessary to test all LEDs. Next, release the pushbutton to automatically start Stage 2. Once Stage 2 has started, the pushbutton can be released. When Stage 2 is completed, Stage 3 will automatically start. The test may be aborted at any time by pressing the pushbutton.

c) TRIP AND ALARM LEADS

PATH: SETTINGS ⇒ PRODUCT SETUP ⇒ USER-PROGRAMMABLE LEADS ⇒ TRIP & ALARM LEADS

<input checked="" type="checkbox"/> TRIP & ALARM LEADS <input type="checkbox"/> MESSAGE	<input type="button" value="◀"/> <input type="button" value="▶"/>	TRIP LED INPUT: Off	Range: FlexLogic™ operand
	<input type="button" value="▲"/>	ALARM LED INPUT: Off	Range: FlexLogic™ operand

The Trip and Alarm LEDs are on LED Panel 1. Each indicator can be programmed to become illuminated when the selected FlexLogic™ operand is in the Logic 1 state.

d) USER-PROGRAMMABLE LED 1(48)

PATH: SETTINGS ⇒ PRODUCT SETUP ⇒ USER-PROGRAMMABLE LEADS ⇒ USER-PROGRAMMABLE LED 1(48)

<input checked="" type="checkbox"/> USER-PROGRAMMABLE <input checked="" type="checkbox"/> LED 1	<input type="button" value="◀"/> <input type="button" value="▶"/>	LED 1 OPERAND: Off	Range: FlexLogic™ operand
	<input type="button" value="▲"/>	LED 1 TYPE: Self-Reset	Range: Self-Reset, Latched

There are 48 amber LEDs across the relay faceplate LED panels. Each of these indicators can be programmed to illuminate when the selected FlexLogic™ operand is in the Logic 1 state.

- LEDs 1 through 24 inclusive are on LED Panel 2; LEDs 25 through 48 inclusive are on LED Panel 3.

Refer to the LED Indicators section in Chapter 4 for the locations of these indexed LEDs. This menu selects the operands to control these LEDs. Support for applying user-customized labels to these LEDs is provided. If the LED X TYPE setting is “Self-Reset” (default setting), the LED illumination will track the state of the selected LED operand. If the LED X TYPE setting is ‘Latched’, the LED, once lit, remains so until reset by the faceplate RESET button, from a remote device via a communications channel, or from any programmed operand, even if the LED operand state de-asserts.

Table 5–3: RECOMMENDED SETTINGS FOR LED PANEL 2 LABELS

SETTING	PARAMETER	SETTING	PARAMETER
LED 1 Operand	SETTING GROUP ACT 1	LED 13 Operand	Off
LED 2 Operand	SETTING GROUP ACT 2	LED 14 Operand	Off
LED 3 Operand	SETTING GROUP ACT 3	LED 15 Operand	Off
LED 4 Operand	SETTING GROUP ACT 4	LED 16 Operand	Off
LED 5 Operand	SETTING GROUP ACT 5	LED 17 Operand	Off
LED 6 Operand	SETTING GROUP ACT 6	LED 18 Operand	Off
LED 7 Operand	Off	LED 19 Operand	Off
LED 8 Operand	Off	LED 20 Operand	Off
LED 9 Operand	Off	LED 21 Operand	Off
LED 10 Operand	Off	LED 22 Operand	Off
LED 11 Operand	Off	LED 23 Operand	Off
LED 12 Operand	Off	LED 24 Operand	Off

Refer to the *Control of Setting Groups* example in the *Control Elements* section of this chapter for group activation.

5.2.12 USER-PROGRAMMABLE SELF TESTS

PATH: SETTINGS ⇒ PRODUCT SETUP ⇨ USER-PROGRAMMABLE SELF TESTS

<div style="border: 1px solid black; padding: 2px;"> ■ USER-PROGRAMMABLE ■ SELF TESTS </div>		<div style="border: 1px solid black; padding: 2px;"> DIRECT RING BREAK FUNCTION: Enabled </div>	Range: Disabled, Enabled. Valid for units equipped with Direct Input/Output module.
MESSAGE	<div style="border: 1px solid black; padding: 2px;"> DIRECT DEVICE OFF FUNCTION: Enabled </div>	<div style="border: 1px solid black; padding: 2px;"> DIRECT RING BREAK FUNCTION: Enabled </div>	Range: Disabled, Enabled. Valid for units equipped with Direct Input/Output module.
MESSAGE	<div style="border: 1px solid black; padding: 2px;"> REMOTE DEVICE OFF FUNCTION: Enabled </div>	<div style="border: 1px solid black; padding: 2px;"> DIRECT DEVICE OFF FUNCTION: Enabled </div>	Range: Disabled, Enabled. Valid for units that contain a CPU with Ethernet capability.
MESSAGE	<div style="border: 1px solid black; padding: 2px;"> PRI. ETHERNET FAIL FUNCTION: Disabled </div>	<div style="border: 1px solid black; padding: 2px;"> REMOTE DEVICE OFF FUNCTION: Enabled </div>	Range: Disabled, Enabled. Valid for units that contain a CPU with a primary fiber port.
MESSAGE	<div style="border: 1px solid black; padding: 2px;"> SEC. ETHERNET FAIL FUNCTION: Disabled </div>	<div style="border: 1px solid black; padding: 2px;"> PRI. ETHERNET FAIL FUNCTION: Disabled </div>	Range: Disabled, Enabled. Valid for units that contain a CPU with a redundant fiber port.
MESSAGE	<div style="border: 1px solid black; padding: 2px;"> BATTERY FAIL FUNCTION: Enabled </div>	<div style="border: 1px solid black; padding: 2px;"> SEC. ETHERNET FAIL FUNCTION: Disabled </div>	Range: Disabled, Enabled.
MESSAGE	<div style="border: 1px solid black; padding: 2px;"> SNTP FAIL FUNCTION: Enabled </div>	<div style="border: 1px solid black; padding: 2px;"> BATTERY FAIL FUNCTION: Enabled </div>	Range: Disabled, Enabled. Valid for units that contain a CPU with Ethernet capability.
MESSAGE	<div style="border: 1px solid black; padding: 2px;"> IRIG-B FAIL FUNCTION: Enabled </div>	<div style="border: 1px solid black; padding: 2px;"> SNTP FAIL FUNCTION: Enabled </div>	Range: Disabled, Enabled.

5

All major self-test alarms are reported automatically with their corresponding FlexLogic™ operands, events, and targets. Most of the Minor Alarms can be disabled if desired.

When in the “Disabled” mode, minor alarms will not assert a FlexLogic™ operand, write to the event recorder, display target messages. Moreover, they will not trigger the **ANY MINOR ALARM** or **ANY SELF-TEST** messages. When in the “Enabled” mode, minor alarms continue to function along with other major and minor alarms. Refer to the *Relay Self-Tests* section in Chapter 7 for additional information on major and minor self-test alarms.

5.2.13 CONTROL PUSHBUTTONS

PATH: SETTINGS ⇒ PRODUCT SETUP ⇒ CONTROL PUSHBUTTONS ⇒ CONTROL PUSHBUTTON 1(7)

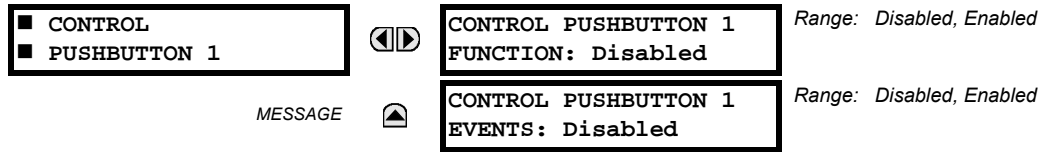

The three standard pushbuttons located on the top left panel of the faceplate are user-programmable and can be used for various applications such as performing an LED test, switching setting groups, and invoking and scrolling through user-programmable displays, etc. The location of the control pushbuttons in the following figure.

An additional four control pushbuttons are included when the T60 is ordered with twelve user programmable pushbuttons.

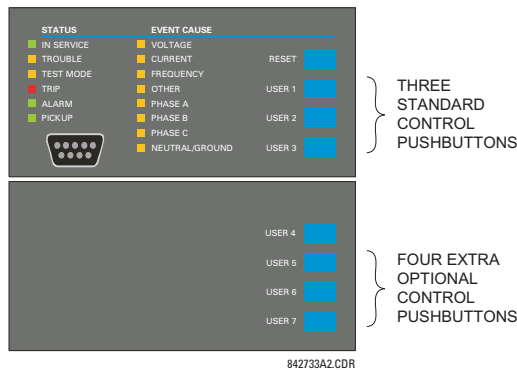

Figure 5-4: CONTROL PUSHBUTTONS

Control pushbuttons are not typically used for critical operations and are not protected by the control password. However, by supervising their output operands, the user can dynamically enable or disable control pushbuttons for security reasons.

Each control pushbutton asserts its own FlexLogic™ operand, CONTROL PUSHBTN 1(7) ON. These operands should be configured appropriately to perform the desired function. The operand remains asserted as long as the pushbutton is pressed and resets when the pushbutton is released. A dropout delay of 100 ms is incorporated to ensure fast pushbutton manipulation will be recognized by various features that may use control pushbuttons as inputs.

An event is logged in the Event Record (as per user setting) when a control pushbutton is pressed; no event is logged when the pushbutton is released. The faceplate keys (including control keys) cannot be operated simultaneously – a given key must be released before the next one can be pressed.

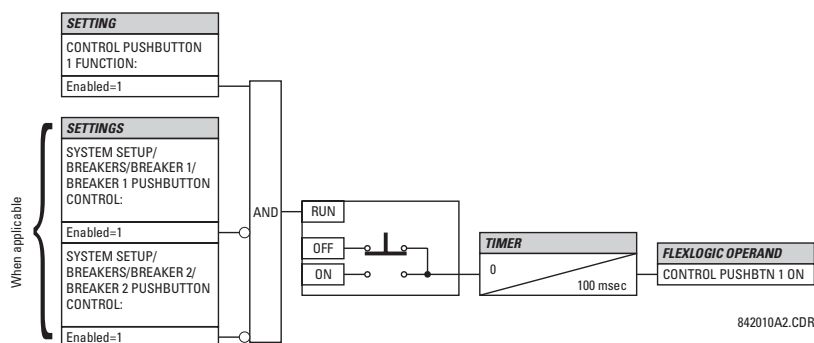

Figure 5-5: CONTROL PUSHBUTTON LOGIC

5.2.14 USER-PROGRAMMABLE PUSHBUTTONS

PATH: SETTINGS ⇒ PRODUCT SETUP ⇨ USER-PROGRAMMABLE PUSHBUTTONS ⇨ USER PUSHBUTTON 1(12)

■ USER PUSHBUTTON 1	◀▶	PUSHBUTTON 1 FUNCTION: Disabled	Range: Self-Reset, Latched, Disabled
MESSAGE	▲▼	PUSHBTN 1 ID TEXT:	Range: Up to 20 alphanumeric characters
MESSAGE	▲▼	PUSHBTN 1 ON TEXT:	Range: Up to 20 alphanumeric characters
MESSAGE	▲▼	PUSHBTN 1 OFF TEXT:	Range: Up to 20 alphanumeric characters
MESSAGE	▲▼	PUSHBTN 1 DROP-OUT TIME: 0.00 s	Range: 0 to 60.00 s in steps of 0.01
MESSAGE	▲▼	PUSHBUTTON 1 TARGETS: Disabled	Range: Self-Reset, Latched, Disabled
MESSAGE	▲	PUSHBUTTON 1 EVENTS: Disabled	Range: Disabled, Enabled

The T60 has 12 optional user-programmable pushbuttons available, each configured via 12 identical menus. The pushbuttons provide an easy and error-free method of manually entering digital information (On, Off) into FlexLogic™ equations as well as protection and control elements. Typical applications include breaker control, autorecloser blocking, ground protection blocking, and setting groups changes.

The user-configurable pushbuttons are shown below. They can be custom labeled with a factory-provided template, available online at <http://www.GEmultilin.com>.



Figure 5-6: USER-PROGRAMMABLE PUSHBUTTONS

Each pushbutton asserts its own On and Off FlexLogic™ operands, respectively. FlexLogic™ operands should be used to program desired pushbutton actions. The operand names are PUSHBUTTON 1 ON and PUSHBUTTON 1 OFF.

A pushbutton may be programmed to latch or self-reset. An indicating LED next to each pushbutton signals the present status of the corresponding "On" FlexLogic™ operand. When set to "Latched", the state of each pushbutton is stored in non-volatile memory which is maintained during any supply power loss.

Pushbuttons states can be logged by the Event Recorder and displayed as target messages. User-defined messages can also be associated with each pushbutton and displayed when the pushbutton is ON.

- **PUSHBUTTON 1 FUNCTION:** This setting selects the characteristic of the pushbutton. If set to "Disabled", the pushbutton is deactivated and the corresponding FlexLogic™ operands (both "On" and "Off") are de-asserted. If set to "Self-reset", the control logic of the pushbutton asserts the "On" corresponding FlexLogic™ operand as long as the pushbutton is being pressed. As soon as the pushbutton is released, the FlexLogic™ operand is de-asserted. The "Off" operand is asserted/de-asserted accordingly.

If set to "Latched", the control logic alternates the state of the corresponding FlexLogic™ operand between "On" and "Off" on each push of the button. When operating in "Latched" mode, FlexLogic™ operand states are stored in non-volatile memory. Should power be lost, the correct pushbutton state is retained upon subsequent power up of the relay.

- **PUSHBTN 1 ID TEXT:** This setting specifies the top 20-character line of the user-programmable message and is intended to provide ID information of the pushbutton. Refer to the User-Definable Displays section for instructions on how to enter alphanumeric characters from the keypad.
- **PUSHBTN 1 ON TEXT:** This setting specifies the bottom 20-character line of the user-programmable message and is displayed when the pushbutton is in the “on” position. Refer to the User-Definable Displays section for instructions on entering alphanumeric characters from the keypad.
- **PUSHBTN 1 OFF TEXT:** This setting specifies the bottom 20-character line of the user-programmable message and is displayed when the pushbutton is activated from the On to the Off position and the **PUSHBUTTON 1 FUNCTION** is “Latched”. This message is not displayed when the **PUSHBUTTON 1 FUNCTION** is “Self-reset” as the pushbutton operand status is implied to be “Off” upon its release. All user text messaging durations for the pushbuttons are configured with the **PRODUCT SETUP** ⇒ **DISPLAY PROPERTIES** ⇒ **FLASH MESSAGE TIME** setting.
- **PUSHBTN 1 DROP-OUT TIME:** This setting specifies a drop-out time delay for a pushbutton in the self-reset mode. A typical applications for this setting is providing a select-before-operate functionality. The selecting pushbutton should have the drop-out time set to a desired value. The operating pushbutton should be logically ANDed with the selecting pushbutton in FlexLogic™. The selecting pushbutton LED remains on for the duration of the drop-out time, signaling the time window for the intended operation.

For example, consider a relay with the following settings: **PUSHBTN 1 ID TEXT:** “AUTORECLOSER”, **PUSHBTN 1 ON TEXT:** “DISABLED - CALL 2199”, and **PUSHBTN 1 OFF TEXT:** “ENABLED”. When Pushbutton 1 changes its state to the “On” position, the following **AUTOCLOSER DISABLED – Call 2199** message is displayed: When Pushbutton 1 changes its state to the “Off” position, the message will change to **AUTORECLOSER ENABLED**.



User-programmable pushbuttons require a type HP relay faceplate. If an HP-type faceplate was ordered separately, the relay order code must be changed to indicate the HP faceplate option. This can be done via EnerVista UR Setup with the **Maintenance > Enable Pushbutton** command.

5.2.15 FLEX STATE PARAMETERS

PATH: SETTINGS ⇒ PRODUCT SETUP ⇒ FLEX STATE PARAMETERS

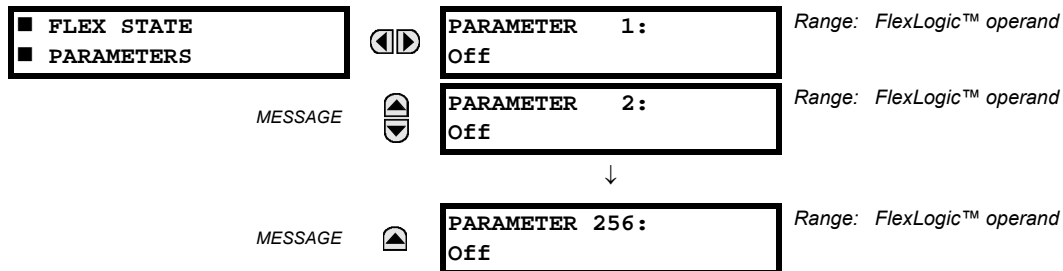

This feature provides a mechanism where any of 256 selected FlexLogic™ operand states can be used for efficient monitoring. The feature allows user-customized access to the FlexLogic™ operand states in the relay. The state bits are packed so that 16 states may be read out in a single Modbus register. The state bits can be configured so that all of the states which are of interest to the user are available in a minimum number of Modbus registers.

The state bits may be read out in the “Flex States” register array beginning at Modbus address 900 hex. 16 states are packed into each register, with the lowest-numbered state in the lowest-order bit. There are 16 registers in total to accommodate the 256 state bits.

5.2.16 USER-DEFINABLE DISPLAYS

a) MAIN MENU

PATH: SETTINGS ⇒ PRODUCT SETUP ⇨⇩ USER-DEFINABLE DISPLAYS

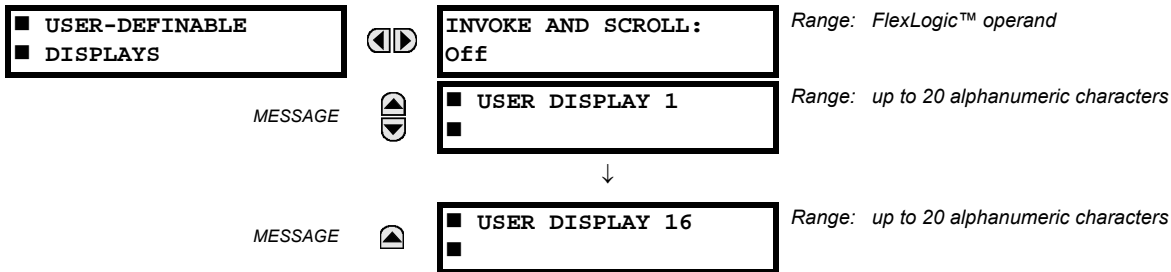

This menu provides a mechanism for manually creating up to 16 user-defined information displays in a convenient viewing sequence in the **USER DISPLAYS** menu (between the **TARGETS** and **ACTUAL VALUES** top-level menus). The sub-menus facilitate text entry and Modbus Register data pointer options for defining the User Display content.

Once programmed, the user-definable displays can be viewed in two ways.

- **KEYPAD:** Use the Menu key to select the **USER DISPLAYS** menu item to access the first user-definable display (note that only the programmed screens are displayed). The screens can be scrolled using the Up and Down keys. The display disappears after the default message time-out period specified by the **PRODUCT SETUP** ⇨⇩ **DISPLAY PROPERTIES** ⇨⇩ **DEFAULT MESSAGE TIMEOUT** setting.
- **USER-PROGRAMMABLE CONTROL INPUT:** The user-definable displays also respond to the **INVOKE AND SCROLL** setting. Any FlexLogic™ operand (in particular, the user-programmable pushbutton operands), can be used to navigate the programmed displays.

On the rising edge of the configured operand (such as when the pushbutton is pressed), the displays are invoked by showing the last user-definable display shown during the previous activity. From this moment onward, the operand acts exactly as the Down key and allows scrolling through the configured displays. The last display wraps up to the first one. The **INVOKE AND SCROLL** input and the Down keypad key operate concurrently.

When the default timer expires (set by the **DEFAULT MESSAGE TIMEOUT** setting), the relay will start to cycle through the user displays. The next activity of the **INVOKE AND SCROLL** input stops the cycling at the currently displayed user display, not at the first user-defined display. The **INVOKE AND SCROLL** pulses must last for at least 250 ms to take effect.

b) USER DISPLAY 1(16)

PATH: SETTINGS ⇒ PRODUCT SETUP ⇨⇩ USER-DEFINABLE DISPLAYS ⇨ USER DISPLAY 1(16)

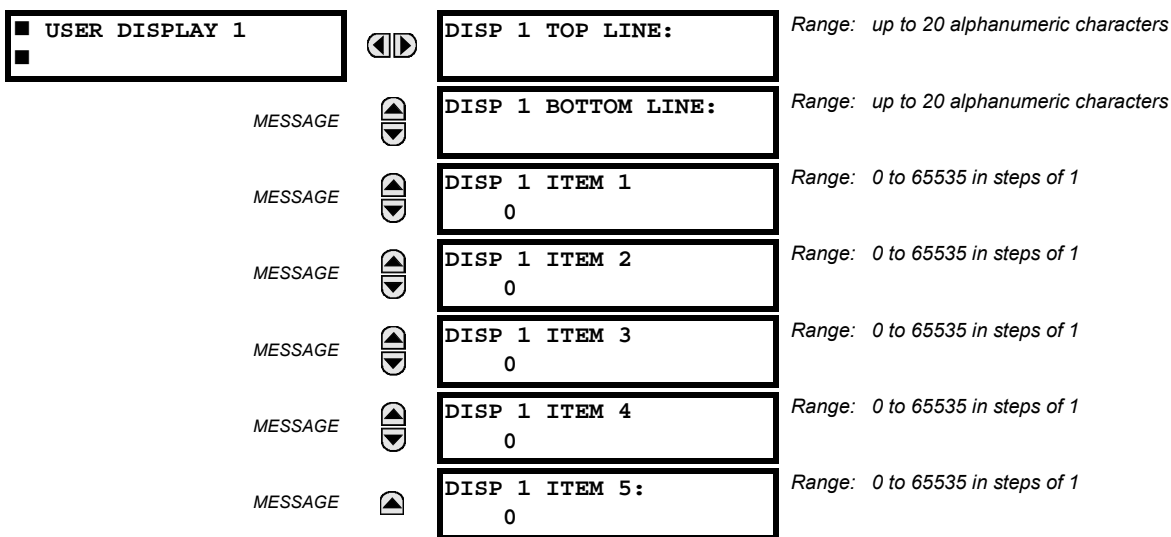

Any existing system display can be automatically copied into an available user display by selecting the existing display and pressing the **ENTER** key. The display will then prompt **ADD TO USER DISPLAY LIST?**. After selecting “Yes”, a message indicates that the selected display has been added to the user display list. When this type of entry occurs, the sub-menus are automatically configured with the proper content – this content may subsequently be edited.

This menu is used to enter user-defined text and/or user-selected Modbus-registered data fields into the particular user display. Each user display consists of two 20-character lines (top and bottom). The tilde (~) character is used to mark the start of a data field - the length of the data field needs to be accounted for. Up to 5 separate data fields (**ITEM 1(5)**) can be entered in a user display - the *n*th tilde (~) refers to the *n*th item.

A User Display may be entered from the faceplate keypad or the EnerVista UR Setup interface (preferred for convenience). The following procedure shows how to enter text characters in the top and bottom lines from the faceplate keypad:

1. Select the line to be edited.
2. Press the **ENTER** key to enter text edit mode.
3. Use either Value key to scroll through the characters. A space is selected like a character.
4. Press the **ENTER** key to advance the cursor to the next position.
5. Repeat step 3 and continue entering characters until the desired text is displayed.
6. The **HELP** key may be pressed at any time for context sensitive help information.
7. Press the **ENTER** key to store the new settings.

To enter a numerical value for any of the 5 items (the *decimal form* of the selected Modbus address) from the faceplate keypad, use the number keypad. Use the value of '0' for any items not being used. Use the **HELP** key at any selected system display (setting, actual value, or command) which has a Modbus address, to view the *hexadecimal form* of the Modbus address, then manually convert it to decimal form before entering it (EnerVista UR Setup usage conveniently facilitates this conversion).

Use the **MENU** key to go to the user displays menu to view the user-defined content. The current user displays will show in sequence, changing every 4 seconds. While viewing a user display, press the **ENTER** key and then select the “Yes” option to remove the display from the user display list. Use the **MENU** key again to exit the user displays menu.

An example User Display setup and result is shown below:

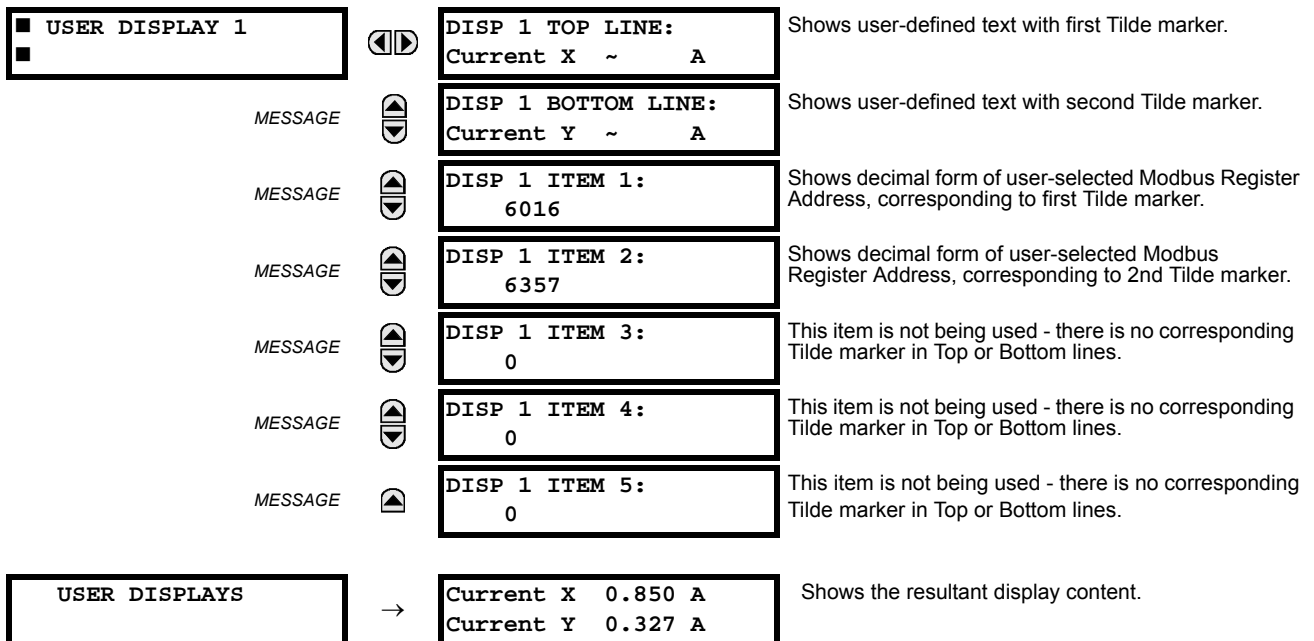

5.2.17 DIRECT INPUTS/OUTPUTS

a) MAIN MENU

PATH: SETTINGS ⇒ PRODUCT SETUP ⇨ DIRECT I/O

■ DIRECT I/O	◀▶	DIRECT OUTPUT DEVICE ID: 1	Range: 1 to 16
MESSAGE	▲▼	DIRECT I/O CH1 RING CONFIGURATION: Yes	Range: Yes, No
MESSAGE	▲▼	DIRECT I/O CH2 RING CONFIGURATION: Yes	Range: Yes, No
MESSAGE	▲▼	DIRECT I/O DATA RATE: 64 kbps	Range: 64 kbps, 128 kbps
MESSAGE	▲▼	DIRECT I/O CHANNEL CROSSOVER: Disabled	Range: Disabled, Enabled
MESSAGE	▲▼	■ CRC ALARM CH1 ■	See page 5-42.
MESSAGE	▲▼	■ CRC ALARM CH2 ■	See page 5-42.
MESSAGE	▲▼	■ UNRETURNED ■ MESSAGES ALARM CH1	See page 5-43.
MESSAGE	▲	■ UNRETURNED ■ MESSAGES ALARM CH2	See page 5-43.

Direct inputs/outputs are intended for exchange of status information (inputs and outputs) between UR-series relays connected directly via Type-7 digital communications cards. The mechanism is very similar to IEC 61850 GSSE, except that communications takes place over a non-switchable isolated network and is optimized for speed. On Type 7 cards that support two channels, direct output messages are sent from both channels simultaneously. This effectively sends direct output messages both ways around a ring configuration. On Type 7 cards that support one channel, direct output messages are sent only in one direction. Messages will be resent (forwarded) when it is determined that the message did not originate at the receiver.

Direct output message timing is similar to GSSE message timing. Integrity messages (with no state changes) are sent at least every 1000 ms. Messages with state changes are sent within the main pass scanning the inputs and asserting the outputs unless the communication channel bandwidth has been exceeded. Two Self-Tests are performed and signaled by the following FlexLogic™ operands:

1. DIRECT RING BREAK (direct input/output ring break). This FlexLogic™ operand indicates that direct output messages sent from a UR-series relay are not being received back by the relay.
2. DIRECT DEVICE 1(16) OFF (direct device offline). This FlexLogic™ operand indicates that direct output messages from at least one direct device are not being received.

Direct input/output settings are similar to remote input/output settings. The equivalent of the remote device name strings for direct inputs/outputs is the **DIRECT OUTPUT DEVICE ID**. The **DIRECT OUTPUT DEVICE ID** identifies the relay in all direct output messages. All UR-series IEDs in a ring should have unique numbers assigned. The IED ID is used to identify the sender of the direct input/output message.

If the direct input/output scheme is configured to operate in a ring (**DIRECT I/O RING CONFIGURATION**: "Yes"), all direct output messages should be received back. If not, the Direct Input/Output Ring Break self-test is triggered. The self-test error is signaled by the **DIRECT RING BREAK** FlexLogic™ operand.

Select the **DIRECT I/O DATA RATE** to match the data capabilities of the communications channel. Back-to-back connections of the local relays configured with the 7A, 7B, 7C, 7D, 7H, 7I, 7J, 7K, 72 and 73 fiber optic communication cards may be set to 128 kbps. For local relays configured with all other communication cards (i.e. 7E, 7F, 7G, 7L, 7M, 7N, 7P, 7R, 7S, 7T, 7W, 74, 75, 76 and 77), the baud rate will be set to 64 kbps. All IEDs communicating over direct inputs/outputs must be set to

the same data rate. UR-series IEDs equipped with dual-channel communications cards apply the same data rate to both channels. Delivery time for direct input/output messages is approximately 0.2 of a power system cycle at 128 kbps and 0.4 of a power system cycle at 64 kbps, per each 'bridge'.



The G.703 and RS422 modules are fixed at 64 kbps only. The SETTINGS ⇒ PRODUCT SETUP ⇒ DIRECT I/O ⇒ DIRECT I/O DATA RATE setting is not applicable to these modules.

The **DIRECT I/O CHANNEL CROSSOVER** setting applies to T60s with dual-channel communication cards and allows crossing over messages from Channel 1 to Channel 2. This places all UR-series IEDs into one direct input/output network regardless of the physical media of the two communication channels.

The following application examples illustrate the basic concepts for direct input/output configuration. Please refer to the *Inputs/Outputs* section in this chapter for information on configuring FlexLogic™ operands (flags, bits) to be exchanged.

EXAMPLE 1: EXTENDING THE INPUT/OUTPUT CAPABILITIES OF A UR-SERIES RELAY

Consider an application that requires additional quantities of digital inputs and/or output contacts and/or lines of programmable logic that exceed the capabilities of a single UR-series chassis. The problem is solved by adding an extra UR-series IED, such as the C30, to satisfy the additional input/output and programmable logic requirements. The two IEDs are connected via single-channel digital communication cards as shown in the figure below.

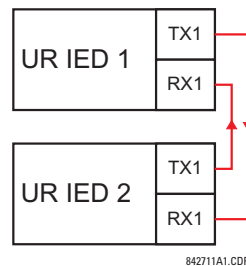

Figure 5–7: INPUT/OUTPUT EXTENSION VIA DIRECT INPUTS/OUTPUTS

In the above application, the following settings should be applied:

UR IED 1: **DIRECT OUTPUT DEVICE ID:** "1"
DIRECT I/O RING CONFIGURATION: "Yes"
DIRECT I/O DATA RATE: "128 kbps"

UR IED 2: **DIRECT OUTPUT DEVICE ID:** "2"
DIRECT I/O RING CONFIGURATION: "Yes"
DIRECT I/O DATA RATE: "128 kbps"

The message delivery time is about 0.2 of power cycle in both ways (at 128 kbps); i.e., from Device 1 to Device 2, and from Device 2 to Device 1. Different communications cards can be selected by the user for this back-to-back connection (fiber, G.703, or RS422).

EXAMPLE 2: INTERLOCKING BUSBAR PROTECTION

A simple interlocking busbar protection scheme could be accomplished by sending a blocking signal from downstream devices, say 2, 3, and 4, to the upstream device that monitors a single incomer of the busbar, as shown below.

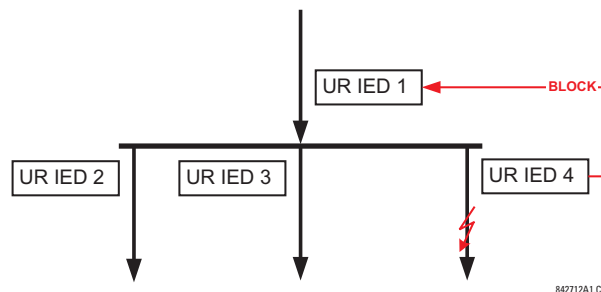

Figure 5–8: SAMPLE INTERLOCKING BUSBAR PROTECTION SCHEME

For increased reliability, a dual-ring configuration (shown below) is recommended for this application.

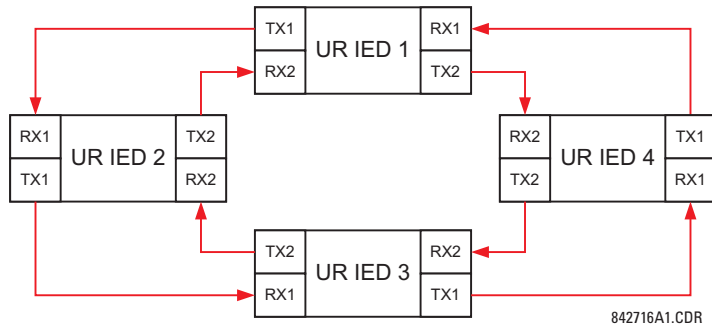

Figure 5-9: INTERLOCKING BUS PROTECTION SCHEME VIA DIRECT INPUTS/OUTPUTS

In the above application, the following settings should be applied:

UR IED 1:	DIRECT OUTPUT DEVICE ID: "1"	UR IED 2:	DIRECT OUTPUT DEVICE ID: "2"
	DIRECT I/O RING CONFIGURATION: "Yes"		DIRECT I/O RING CONFIGURATION: "Yes"
UR IED 3:	DIRECT OUTPUT DEVICE ID: "3"	UR IED 4:	DIRECT OUTPUT DEVICE ID: "4"
	DIRECT I/O RING CONFIGURATION: "Yes"		DIRECT I/O RING CONFIGURATION: "Yes"

Message delivery time is approximately 0.2 of power system cycle (at 128 kbps) times number of 'bridges' between the origin and destination. Dual-ring configuration effectively reduces the maximum 'communications distance' by a factor of two.

In this configuration the following delivery times are expected (at 128 kbps) if both rings are healthy:

IED 1 to IED 2: 0.2 of power system cycle; IED 1 to IED 3: 0.4 of power system cycle;
 IED 1 to IED 4: 0.2 of power system cycle; IED 2 to IED 3: 0.2 of power system cycle;
 IED 2 to IED 4: 0.4 of power system cycle; IED 3 to IED 4: 0.2 of power system cycle

If one ring is broken (say TX2/RX2) the delivery times are as follows:

IED 1 to IED 2: 0.2 of power system cycle; IED 1 to IED 3: 0.4 of power system cycle;
 IED 1 to IED 4: 0.6 of power system cycle; IED 2 to IED 3: 0.2 of power system cycle;
 IED 2 to IED 4: 0.4 of power system cycle; IED 3 to IED 4: 0.2 of power system cycle

A coordinating timer for this bus protection scheme could be selected to cover the worst case scenario (0.4 of power system cycle). Upon detecting a broken ring, the coordination time should be adaptively increased to 0.6 of power system cycle. The complete application requires addressing a number of issues such as failure of both the communications rings, failure or out-of-service conditions of one of the relays, etc. Self-monitoring flags of the direct inputs/outputs feature would be primarily used to address these concerns.

EXAMPLE 3: PILOT-AIDED SCHEMES

Consider the three-terminal line protection application shown below:

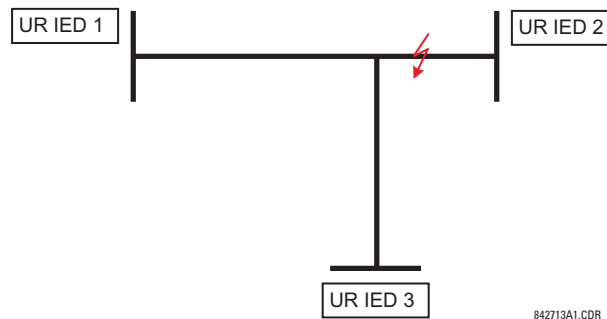

Figure 5-10: THREE-TERMINAL LINE APPLICATION

A permissive pilot-aided scheme could be implemented in a two-ring configuration as shown below (IEDs 1 and 2 constitute a first ring, while IEDs 2 and 3 constitute a second ring):

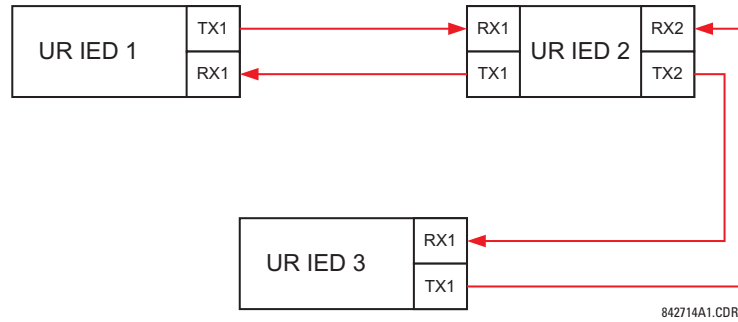

Figure 5-11: SINGLE-CHANNEL OPEN LOOP CONFIGURATION

In the above application, the following settings should be applied:

- | | | | |
|-----------|---|-----------|---|
| UR IED 1: | DIRECT OUTPUT DEVICE ID: "1" | UR IED 2: | DIRECT OUTPUT DEVICE ID: "2" |
| | DIRECT I/O RING CONFIGURATION: "Yes" | | DIRECT I/O RING CONFIGURATION: "Yes" |
| UR IED 3: | DIRECT OUTPUT DEVICE ID: "3" | | |
| | DIRECT I/O RING CONFIGURATION: "Yes" | | |

In this configuration the following delivery times are expected (at 128 kbps):

- IED 1 to IED 2: 0.2 of power system cycle; IED 1 to IED 3: 0.5 of power system cycle;
- IED 2 to IED 3: 0.2 of power system cycle

In the above scheme, IEDs 1 and 3 do not communicate directly. IED 2 must be configured to forward the messages as explained in the *Inputs/Outputs* section. A blocking pilot-aided scheme should be implemented with more security and, ideally, faster message delivery time. This could be accomplished using a dual-ring configuration as shown below.

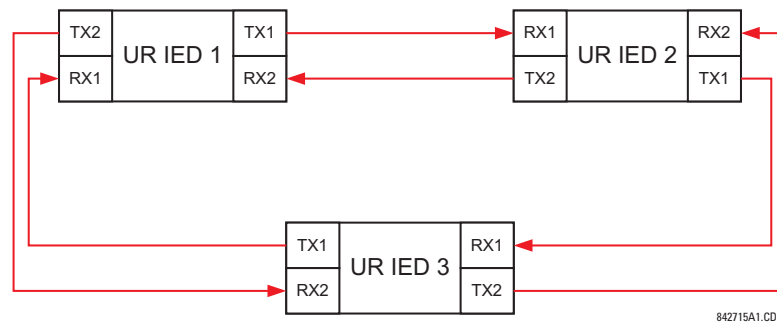

Figure 5-12: DUAL-CHANNEL CLOSED LOOP (DUAL-RING) CONFIGURATION

In the above application, the following settings should be applied:

- | | | | |
|-----------|---|-----------|---|
| UR IED 1: | DIRECT OUTPUT DEVICE ID: "1" | UR IED 2: | DIRECT OUTPUT DEVICE ID: "2" |
| | DIRECT I/O RING CONFIGURATION: "Yes" | | DIRECT I/O RING CONFIGURATION: "Yes" |
| UR IED 3: | DIRECT OUTPUT DEVICE ID: "3" | | |
| | DIRECT I/O RING CONFIGURATION: "Yes" | | |

In this configuration the following delivery times are expected (at 128 kbps) if both the rings are healthy:

- IED 1 to IED 2: 0.2 of power system cycle; IED 1 to IED 3: 0.2 of power system cycle;
- IED 2 to IED 3: 0.2 of power system cycle

The two communications configurations could be applied to both permissive and blocking schemes. Speed, reliability and cost should be taken into account when selecting the required architecture.

b) CRC ALARM 1(2)

PATH: SETTINGS ⇒ PRODUCT SETUP ⇒ DIRECT I/O ⇒ CRC ALARM CH1(2)

<input checked="" type="checkbox"/> CRC ALARM CH1	◀▶	CRC ALARM CH1 FUNCTION: Disabled	Range: Enabled, Disabled
MESSAGE	▲▼	CRC ALARM CH1 MESSAGE COUNT: 600	Range: 100 to 10000 in steps of 1
MESSAGE	▲▼	CRC ALARM CH1 THRESHOLD: 10	Range: 1 to 1000 in steps of 1
MESSAGE	▲	CRC ALARM CH1 EVENTS: Disabled	Range: Enabled, Disabled

The T60 checks integrity of the incoming direct input/output messages using a 32-bit CRC. The CRC Alarm function is available for monitoring the communication medium noise by tracking the rate of messages failing the CRC check. The monitoring function counts all incoming messages, including messages that failed the CRC check. A separate counter adds up messages that failed the CRC check. When the failed CRC counter reaches the user-defined level specified by the **CRC ALARM CH1 THRESHOLD** setting within the user-defined message count **CRC ALARM 1 CH1 COUNT**, the DIR IO CH1 CRC ALARM FlexLogic™ operand is set.

When the total message counter reaches the user-defined maximum specified by the **CRC ALARM CH1 MESSAGE COUNT** setting, both the counters reset and the monitoring process is restarted.

The operand shall be configured to drive an output contact, user-programmable LED, or selected communication-based output. Latching and acknowledging conditions - if required - should be programmed accordingly.

The CRC Alarm function is available on a per-channel basis. The total number of direct input/output messages that failed the CRC check is available as the **ACTUAL VALUES ⇒ STATUS ⇒ DIRECT INPUTS ⇒ CRC FAIL COUNT CH1(2)** actual value.

Message Count and Length of the Monitoring Window:

To monitor communications integrity, the relay sends 1 message per second (at 64 kbps) or 2 messages per second (128 kbps) even if there is no change in the direct outputs. For example, setting the **CRC ALARM CH1 MESSAGE COUNT** to “10000”, corresponds a time window of about 160 minutes at 64 kbps and 80 minutes at 128 kbps. If the messages are sent faster as a result of direct outputs activity, the monitoring time interval will shorten. This should be taken into account when determining the **CRC ALARM CH1 MESSAGE COUNT** setting. For example, if the requirement is a maximum monitoring time interval of 10 minutes at 64 kbps, then the **CRC ALARM CH1 MESSAGE COUNT** should be set to $10 \times 60 \times 1 = 600$.

Correlation of Failed CRC and Bit Error Rate (BER):

The CRC check may fail if one or more bits in a packet are corrupted. Therefore, an exact correlation between the CRC fail rate and the BER is not possible. Under certain assumptions an approximation can be made as follows. A direct input/output packet containing 20 bytes results in 160 bits of data being sent and therefore, a transmission of 63 packets is equivalent to 10,000 bits. A BER of 10^{-4} implies 1 bit error for every 10,000 bits sent/received. Assuming the best case of only 1 bit error in a failed packet, having 1 failed packet for every 63 received is about equal to a BER of 10^{-4} .

c) UNRETURNED MESSAGES ALARM 1(2)

PATH: SETTINGS ⇒ PRODUCT SETUP ⇒ DIRECT I/O ⇒ UNRETURNED MESSAGES ALARM CH1(2)

<input checked="" type="checkbox"/> UNRETURNED <input checked="" type="checkbox"/> MESSAGES ALARM CH1		UNRET MSGS ALARM CH1 FUNCTION: Disabled	Range: Enabled, Disabled
MESSAGE		UNRET MSGS ALARM CH1 MESSAGE COUNT: 600	Range: 100 to 10000 in steps of 1
MESSAGE		UNRET MSGS ALARM CH1 THRESHOLD: 10	Range: 1 to 1000 in steps of 1
MESSAGE		UNRET MSGS ALARM CH1 EVENTS: Disabled	Range: Enabled, Disabled

The T60 checks integrity of the direct input/output communication ring by counting unreturned messages. In the ring configuration, all messages originating at a given device should return within a pre-defined period of time. The Unreturned Messages Alarm function is available for monitoring the integrity of the communication ring by tracking the rate of unreturned messages. This function counts all the outgoing messages and a separate counter adds the messages have failed to return. When the unreturned messages counter reaches the user-definable level specified by the **UNRET MSGS ALARM CH1 THRESHOLD** setting and within the user-defined message count **UNRET MSGS ALARM CH1 COUNT**, the DIR IO CH1 UNRET ALM FlexLogic™ operand is set.

When the total message counter reaches the user-defined maximum specified by the **UNRET MSGS ALARM CH1 MESSAGE COUNT** setting, both the counters reset and the monitoring process is restarted.

The operand shall be configured to drive an output contact, user-programmable LED, or selected communication-based output. Latching and acknowledging conditions, if required, should be programmed accordingly.

The Unreturned Messages Alarm function is available on a per-channel basis and is active only in the ring configuration. The total number of unreturned input/output messages is available as the **ACTUAL VALUES ⇒ STATUS ⇒ DIRECT INPUTS ⇒ UNRETURNED MSG COUNT CH1(2)** actual value.

5.2.18 TELEPROTECTION

PATH: SETTINGS ⇒ PRODUCT SETUP ⇒ TELEPROTECTION

<input checked="" type="checkbox"/> TELEPROTECTION <input checked="" type="checkbox"/>		TELEPROTECTION FUNCTION: Disabled	Range: Disabled, Enabled
MESSAGE		NUMBER OF TERMINALS: 2	Range: 2, 3
MESSAGE		NUMBER OF COMM CHANNELS: 1	Range: 1, 2
MESSAGE		LOCAL RELAY ID NUMBER: 0	Range: 0 to 255 in steps of 1
MESSAGE		TERMINAL 1 RELAY ID NUMBER: 0	Range: 0 to 255 in steps of 1
MESSAGE		TERMINAL 2 RELAY ID NUMBER: 0	Range: 0 to 255 in steps of 1

Digital teleprotection functionality is designed to transfer protection commands between 2 or 3 relays in a secure, fast, dependable, and deterministic fashion. Possible applications are permissive or blocking pilot schemes and direct transfer trip (DTT). Teleprotection can be applied over any analog or digital channels and any communications media, such as direct fiber, copper wires, optical networks, or microwave radio links. A mixture of communication media is possible.

Once teleprotection is enabled and the teleprotection input/outputs are configured, data packets are transmitted continuously every 1/4 cycle (3/8 cycle if using C37.94 modules) from peer-to-peer. Security of communication channel data is achieved by using CRC-32 on the data packet.



Teleprotection inputs/outputs and direct inputs/outputs are mutually exclusive – as such, they cannot be used simultaneously. Once teleprotection inputs/outputs are enabled, direct inputs/outputs are blocked, and *vice versa*.

- **NUMBER OF TERMINALS:** Specifies whether the teleprotection system operates between 2 peers or 3 peers.
- **NUMBER OF CHANNELS:** Specifies how many channels are used. If the **NUMBER OF TERMINALS** is “3” (three-terminal system), set the **NUMBER OF CHANNELS** to “2”. For a two-terminal system, the **NUMBER OF CHANNELS** can set to “1” or “2” (redundant channels).
- **LOCAL RELAY ID NUMBER, TERMINAL 1 RELAY ID NUMBER, and TERMINAL 2 RELAY ID NUMBER:** In installations that use multiplexers or modems, it is desirable to ensure that the data used by the relays protecting a given line is from the correct relays. The teleprotection function performs this check by reading the message ID sent by transmitting relays and comparing it to the programmed ID in the receiving relay. This check is also used to block inputs if inadvertently set to loopback mode or data is being received from a wrong relay by checking the ID on a received channel. If an incorrect ID is found on a channel during normal operation, the TELEPROT CH1(2) ID FAIL FlexLogic™ operand is set, driving the event with the same name and blocking the teleprotection inputs. For commissioning purposes, the result of channel identification is also shown in the **STATUS** ⇒⇅ **CHANNEL TESTS** ⇒⇅ **VALIDITY OF CHANNEL CONFIGURATION** actual value. The default value of “0” for the **LOCAL RELAY ID NUMBER** indicates that relay ID is not to be checked. On two- terminals two-channel systems, the same **LOCAL RELAY ID NUMBER** is transmitted over both channels; as such, only the **TERMINAL 1 ID NUMBER** has to be programmed on the receiving end.

5.2.19 INSTALLATION

PATH: SETTINGS ⇒ PRODUCT SETUP ⇒⇅ INSTALLATION

■ INSTALLATION

■

RELAY SETTINGS:
 Not Programmed

Range: Not Programmed, Programmed

RELAY NAME:
 Relay-1

Range: up to 20 alphanumeric characters

MESSAGE

To safeguard against the installation of a relay without any entered settings, the unit will not allow signaling of any output relay until **RELAY SETTINGS** is set to "Programmed". This setting is defaulted to "Not Programmed" when at the factory. The **UNIT NOT PROGRAMMED** self-test error message is displayed until the relay is put into the "Programmed" state.

The **RELAY NAME** setting allows the user to uniquely identify a relay. This name will appear on generated reports. This name is also used to identify specific devices which are engaged in automatically sending/receiving data over the Ethernet communications channel using the IEC 61850 protocol.

a) CURRENT BANKS

PATH: SETTINGS ⇨ SYSTEM SETUP ⇨ AC INPUTS ⇨ CURRENT BANK F1(M5)

<input type="checkbox"/> CURRENT BANK F1 <input type="checkbox"/>		PHASE CT F1 PRIMARY: 1 A	Range: 1 to 65000 A in steps of 1
	MESSAGE	PHASE CT F1 SECONDARY: 1 A	Range: 1 A, 5 A
	MESSAGE	GROUND CT F1 PRIMARY: 1 A	Range: 1 to 65000 A in steps of 1
	MESSAGE	GROUND CT F1 SECONDARY: 1 A	Range: 1 A, 5 A



Because energy parameters are accumulated, these values should be recorded and then reset immediately prior to changing CT characteristics.

Four banks of phase/ground CTs can be set, where the current banks are denoted in the following format (*X* represents the module slot position letter):

Xa, where ***X*** = {**F**, **M**} and ***a*** = {**1**, **5**}.

See the *Introduction to AC Sources* section at the beginning of this chapter for additional details.

These settings are critical for all features that have settings dependent on current measurements. When the relay is ordered, the CT module must be specified to include a standard or sensitive ground input. As the phase CTs are connected in Wye (star), the calculated phasor sum of the three phase currents ($I_A + I_B + I_C = \text{Neutral Current} = 3I_o$) is used as the input for the neutral overcurrent elements. In addition, a zero-sequence (core balance) CT which senses current in all of the circuit primary conductors, or a CT in a neutral grounding conductor may also be used. For this configuration, the ground CT primary rating must be entered. To detect low level ground fault currents, the sensitive ground input may be used. In this case, the sensitive ground CT primary rating must be entered. Refer to Chapter 3 for more details on CT connections.

Enter the rated CT primary current values. For both 1000:5 and 1000:1 CTs, the entry would be 1000. For correct operation, the CT secondary rating must match the setting (which must also correspond to the specific CT connections used).

The following example illustrates how multiple CT inputs (current banks) are summed as one source current. Given If the following current banks:

F1: CT bank with 500:1 ratio; F5: CT bank with 1000: ratio; M1: CT bank with 800:1 ratio

The following rule applies:

$$\text{SRC 1} = \text{F1} + \text{F5} + \text{M1} \quad (\text{EQ 5.7})$$

1 pu is the highest primary current. In this case, 1000 is entered and the secondary current from the 500:1 ratio CT will be adjusted to that created by a 1000:1 CT before summation. If a protection element is set up to act on SRC 1 currents, then a pickup level of 1 pu will operate on 1000 A primary.

The same rule applies for current sums from CTs with different secondary taps (5 A and 1 A).

b) VOLTAGE BANKS

PATH: SETTINGS ⇒ ⚙ SYSTEM SETUP ⇒ AC INPUTS ⇒ ⚙ VOLTAGE BANK F5(M5)

<input checked="" type="checkbox"/> VOLTAGE BANK F5		PHASE VT F5 CONNECTION: Wye	Range: Wye, Delta
MESSAGE		PHASE VT F5 SECONDARY: 66.4 V	Range: 50.0 to 240.0 V in steps of 0.1
MESSAGE		PHASE VT F5 RATIO: 1.00 :1	Range: 1.00 to 24000.00 in steps of 0.01
MESSAGE		AUXILIARY VT F5 CONNECTION: Vag	Range: Vn, Vag, Vbg, Vcg, Vab, Vbc, Vca
MESSAGE		AUXILIARY VT F5 SECONDARY: 66.4 V	Range: 50.0 to 240.0 V in steps of 0.1
MESSAGE		AUXILIARY VT F5 RATIO: 1.00 :1	Range: 1.00 to 24000.00 in steps of 0.01



Because energy parameters are accumulated, these values should be recorded and then reset immediately prior to changing VT characteristics.

Two banks of phase/auxiliary VTs can be set, where voltage banks are denoted in the following format (X represents the module slot position letter):

Xa, where **X** = {F, M} and **a** = {5}.

See the *Introduction to AC Sources* section at the beginning of this chapter for additional details.

With VTs installed, the relay can perform voltage measurements as well as power calculations. Enter the **PHASE VT F5 CONNECTION** made to the system as “Wye” or “Delta”. An open-delta source VT connection would be entered as “Delta”. See the *Typical Wiring Diagram* in Chapter 3 for details.



The nominal **PHASE VT F5 SECONDARY** voltage setting is the voltage across the relay input terminals when nominal voltage is applied to the VT primary.

For example, on a system with a 13.8 kV nominal primary voltage and with a 14400:120 volt VT in a Delta connection, the secondary voltage would be 115, i.e. $(13800 / 14400) \times 120$. For a Wye connection, the voltage value entered must be the phase to neutral voltage which would be $115 / \sqrt{3} = 66.4$.

On a 14.4 kV system with a Delta connection and a VT primary to secondary turns ratio of 14400:120, the voltage value entered would be 120, i.e. $14400 / 120$.

5.3.2 POWER SYSTEM

PATH: SETTINGS ⇌ SYSTEM SETUP ⇌ POWER SYSTEM

■ POWER SYSTEM	◀▶	NOMINAL FREQUENCY: 60 Hz	Range: 25 to 60 Hz in steps of 1
MESSAGE	▲▼	PHASE ROTATION: ABC	Range: ABC, ACB
MESSAGE	▲▼	FREQUENCY AND PHASE REFERENCE: SRC 1	Range: SRC 1, SRC 2, SRC 3, SRC 4
MESSAGE	▲	FREQUENCY TRACKING: Enabled	Range: Disabled, Enabled

The power system **NOMINAL FREQUENCY** value is used as a default to set the digital sampling rate if the system frequency cannot be measured from available signals. This may happen if the signals are not present or are heavily distorted. Before reverting to the nominal frequency, the frequency tracking algorithm holds the last valid frequency measurement for a safe period of time while waiting for the signals to reappear or for the distortions to decay.

The phase sequence of the power system is required to properly calculate sequence components and power parameters. The **PHASE ROTATION** setting matches the power system phase sequence. Note that this setting informs the relay of the actual system phase sequence, either ABC or ACB. CT and VT inputs on the relay, labeled as A, B, and C, must be connected to system phases A, B, and C for correct operation.

The **FREQUENCY AND PHASE REFERENCE** setting determines which signal source is used (and hence which AC signal) for phase angle reference. The AC signal used is prioritized based on the AC inputs that are configured for the signal source: phase voltages takes precedence, followed by auxiliary voltage, then phase currents, and finally ground current.

For three phase selection, phase A is used for angle referencing ($V_{\text{ANGLE REF}} = V_A$), while Clarke transformation of the phase signals is used for frequency metering and tracking ($V_{\text{FREQUENCY}} = (2V_A - V_B - V_C)/3$) for better performance during fault, open pole, and VT and CT fail conditions.

The phase reference and frequency tracking AC signals are selected based upon the Source configuration, regardless of whether or not a particular signal is actually applied to the relay.

Phase angle of the reference signal will always display zero degrees and all other phase angles will be relative to this signal. If the pre-selected reference signal is not measurable at a given time, the phase angles are not referenced.

The phase angle referencing is done via a phase locked loop, which can synchronize independent UR-series relays if they have the same AC signal reference. These results in very precise correlation of time tagging in the event recorder between different UR-series relays provided the relays have an IRIG-B connection.



FREQUENCY TRACKING should only be set to "Disabled" in very unusual circumstances; consult the factory for special variable-frequency applications.



Systems with a phase sequence of ACB require special consideration as described in the *Phase Relationships of Three-phase Transformers* sub-section of Chapter 5.

5.3.3 SIGNAL SOURCES

PATH: SETTINGS ⇌ SYSTEM SETUP ⇌ SIGNAL SOURCES ⇌ SOURCE 1(4)

■ SOURCE 1	◀▶	SOURCE 1 NAME: SRC 1	Range: up to 6 alphanumeric characters
MESSAGE	▲▼	SOURCE 1 PHASE CT: None	Range: None, F1, F5, F1+F5,... up to a combination of any 6 CTs. Only Phase CT inputs are displayed.
MESSAGE	▲▼	SOURCE 1 GROUND CT: None	Range: None, F1, F5, F1+F5,... up to a combination of any 6 CTs. Only Ground CT inputs are displayed.
MESSAGE	▲▼	SOURCE 1 PHASE VT: None	Range: None, F1, F5, M1, M5 Only phase voltage inputs will be displayed.
MESSAGE	▲	SOURCE 1 AUX VT: None	Range: None, F1, F5, M1, M5 Only auxiliary voltage inputs will be displayed.

Four identical source menus are available. The "SRC 1" text can be replaced by with a user-defined name appropriate for the associated source.

"F" and "M" represent the module slot position. The number directly following these letters represents either the first bank of four channels (1, 2, 3, 4) called "1" or the second bank of four channels (5, 6, 7, 8) called "5" in a particular CT/VT module. Refer to the *Introduction to AC Sources* section at the beginning of this chapter for additional details on this concept.

It is possible to select the sum of up to six (6) CTs. The first channel displayed is the CT to which all others will be referred. For example, the selection "F1+F5" indicates the sum of each phase from channels "F1" and "F5", scaled to whichever CT has the higher ratio. Selecting "None" hides the associated actual values.

The approach used to configure the AC sources consists of several steps; first step is to specify the information about each CT and VT input. For CT inputs, this is the nominal primary and secondary current. For VTs, this is the connection type, ratio and nominal secondary voltage. Once the inputs have been specified, the configuration for each source is entered, including specifying which CTs will be summed together.

User Selection of AC Parameters for Comparator Elements:

CT/VT modules automatically calculate all current and voltage parameters from the available inputs. Users must select the specific input parameters to be measured by every element in the relevant settings menu. The internal design of the element specifies which type of parameter to use and provides a setting for source selection. In elements where the parameter may be either fundamental or RMS magnitude, such as phase time overcurrent, two settings are provided. One setting specifies the source, the second setting selects between fundamental phasor and RMS.

AC Input Actual Values:

The calculated parameters associated with the configured voltage and current inputs are displayed in the current and voltage sections of actual values. Only the phasor quantities associated with the actual AC physical input channels will be displayed here. All parameters contained within a configured source are displayed in the sources section of the actual values.

Disturbance Detectors (Internal):

The 50DD element is a sensitive current disturbance detector that detects any disturbance on the protected system. 50DD is intended for use in conjunction with measuring elements, blocking of current based elements (to prevent maloperation as a result of the wrong settings), and starting oscillography data capture. A disturbance detector is provided for each Source.

The 50DD function responds to the changes in magnitude of the sequence currents. The disturbance detector scheme logic is as follows:

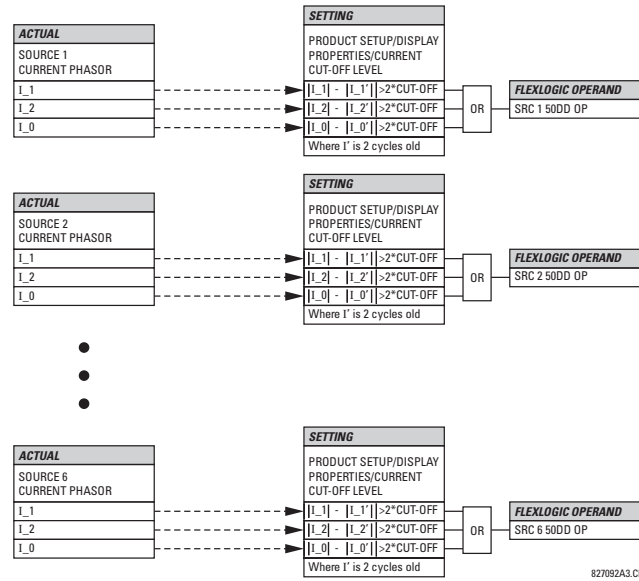

Figure 5-13: DISTURBANCE DETECTOR LOGIC DIAGRAM

The disturbance detector responds to the change in currents of twice the current cut-off level. The default cut-off threshold is 0.02 pu; thus by default the disturbance detector responds to a change of 0.04 pu. The metering sensitivity setting (**PRODUCT SETUP** ⇒ **DISPLAY PROPERTIES** ⇒ **CURRENT CUT-OFF LEVEL**) controls the sensitivity of the disturbance detector accordingly.

Example Use of Sources:

An example of the use of sources, with a relay with two CT/VT modules, is shown in the diagram below. A relay could have the following hardware configuration:

INCREASING SLOT POSITION LETTER -->		
CT/VT MODULE 1	CT/VT MODULE 2	CT/VT MODULE 3
CTs	VTs	not applicable

This configuration could be used on a two winding transformer, with one winding connected into a breaker-and-a-half system. The following figure shows the arrangement of sources used to provide the functions required in this application, and the CT/VT inputs that are used to provide the data.

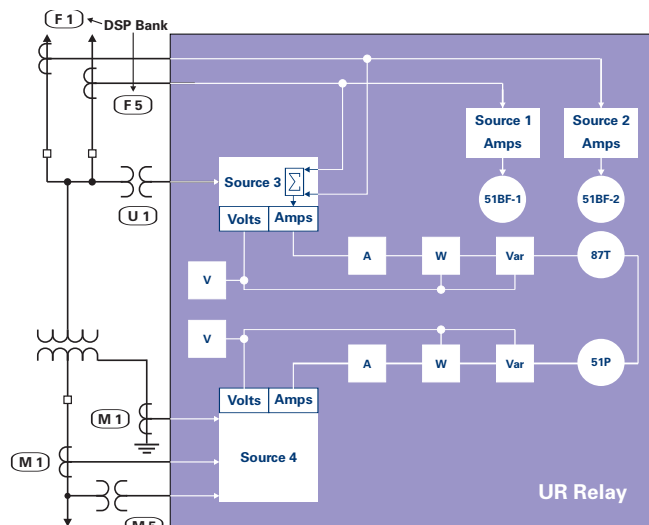

Figure 5-14: EXAMPLE USE OF SOURCES

5.3.4 TRANSFORMER

a) MAIN MENU

PATH: SETTINGS ⇄⇄ SYSTEM SETUP ⇄⇄ TRANSFORMER

■ TRANSFORMER	◀▶	■ GENERAL	See page 5-50.
MESSAGE	▲▼	■ WINDING 1	See page 5-52.
MESSAGE	▲▼	■ WINDING 2	See page 5-52.
MESSAGE	▲▼	■ WINDING 3	See page 5-52.
MESSAGE	▲▼	■ WINDING 4	See page 5-52.
MESSAGE	▲	■ THERMAL INPUTS	See page 5-61.

The T60 Transformer Management Relay has been designed to provide primary protection for medium to high voltage power transformers. It is able to perform this function on 2 to 4 winding transformers in a variety of system configurations.

b) GENERAL TRANSFORMER SETTINGS

PATH: SETTINGS ⇄⇄ SYSTEM SETUP ⇄⇄ TRANSFORMER ⇄ GENERAL

■ GENERAL	◀▶	NUMBER OF WINDINGS: 2	Range: 2 to 6 in steps of 1
MESSAGE	▲▼	REFERENCE WINDING: Automatic Selection	Range: Automatic Selection, Winding 1, Winding 2,..., Winding 6
MESSAGE	▲▼	PHASE COMPENSATION: Internal (software)	Range: Internal (software), External (with CTs)
MESSAGE	▲▼	LOAD LOSS AT RATED LOAD: 100 kW	Range: 1 to 20000 kW in steps of 1
MESSAGE	▲▼	RATED WINDING TEMP RISE: 65°C (oil)	Range: 55°C (oil), 65°C (oil), 80°C (dry), 115°C (dry), 150°C (dry)
MESSAGE	▲▼	NO LOAD LOSS: 10 kW	Range: 1 to 20000 kW in steps of 1
MESSAGE	▲▼	TYPE OF COOLING: OA	Range: OA, FA, Non-directed FOA/FOW, Directed FOA/FOW, Sealed Self Cooled, Vented Self Cooled, Forced Cooled
MESSAGE	▲▼	TOP-OIL RISE OVER AMBIENT: 35°C	Range: 1 to 200°C in steps of 1
MESSAGE	▲▼	THERMAL CAPACITY: 100.00 kWh/°C	Range: 0.00 to 200.00 kWh/°C in steps of 0.01
MESSAGE	▲	WINDING THERMAL TIME CONSTANT: 2.00 min	Range: 0.25 to 15.00 min. in steps of 0.01

The general transformer settings apply to all windings. Settings specific to each winding are shown in the following section.

- **NUMBER OF WINDINGS:** Selects the number of windings for transformer setup.

- **PHASE COMPENSATION:** Selects the type of phase compensation to be performed by the relay. If set to “Internal (software)”, the transformer phase shift is compensated internally by the relay algorithm. If set to “External (with CTs)”, the transformer phase shift is externally compensated by the CT connections.
- **LOAD LOSS AT RATED LOAD:** This setting should be taken from the transformer nameplate. If not available from the nameplate, the setting value can be computed as $P_R = I_{n(W)}^2 \times R$, where $I_{n(W)}$ is the winding rated current and R is the three-phase series resistance. The setting is used as an input for the calculation of the hottest-spot winding temperature.
- **RATED WINDING TEMP RISE:** This setting defines the winding temperature rise over 30°C ambient temperature. The setting is automatically selected for the transformer type as shown in the table below.

The loss of life function calculates the insulation aging acceleration factor using the settings entered in this section, by following equation:

$$F_{AA}(t) = e^{\left(\frac{15000}{\Theta_{H,R} + 273} - \frac{15000}{\Theta_{H(t)} + 273} \right)} \quad (\text{EQ 5.8})$$

where $\Theta_{H,R}$ is the rated hottest-spot temperature as per the table below, and $\Theta_{H(t)}$ is the actual computed winding hottest-spot temperature.

The aging acceleration factor is computed every minute. It has a value of 1.0 when the actual winding hottest spot temperature is equal to the rated temperature, is greater than 1 if the actual temperature is above the rated temperature, and less than 1 if the actual temperature is below the rated temperature.

RATED WINDING TEMPERATURE		POWER CAPACITY	NORMAL LIFE EXPECTANCY	AT $\Theta_{H,R}$
Oil	55°C	≤ 500 kVA	180000 hrs	95°C
		≤ 100 MVA	6.5×10^4 hrs	95°C
	65°C	≤ 500 kVA	20 years	110°C
		≤ 100 MVA	6.5×10^4 hrs	110°C
	> 100 MVA	6.5×10^4 hrs	110°C	
Dry	80°C	Any	20 years	140°C
	115°C	Any	20 years	175°C
	150°C	Any	20 years	210°C

- **NO LOAD LOSS:** This setting is obtained from the transformer data and is used to calculate the aging acceleration factor.
- **TYPE OF COOLING:** The setting defines the type of transformer cooling and is used to calculate the aging acceleration factor. The values and their description for this setting are as follows:

“OA”: oil-air

“FA”: forced air

“Non-directed FOA/FOW”: non-directed forced-oil-air/forced-oil-water

“Directed FOA/FOW”: directed forced-oil-air/forced-oil-water

“Sealed Self Cooled”, “Vented Self Cooled”, “Forced Cooled”: as named

- **TOP OIL RISE OVER AMBIENT:** This setting should be available from the transformer nameplate data
- **THERMAL CAPACITY:** The setting should be available from the transformer nameplate data. If not, refer to the following calculations. For the “OA” and “FA” cooling types:

$C = 0.06$ (core and coil assembly in lbs.) + 0.04 (tank and fittings in lbs.) + 1.33 (gallons of oil), Wh/°C; or

$C = 0.0272$ (core and coil assembly in kg) + 0.01814 (tank and fittings in kg) + 5.034 (L of oil), Wh/°C

For the “Non-directed FOA/FOW” (non-directed forced-oil-air/forced-oil-water) or “Directed FOA/FOW” (directed forced-oil-air/forced-oil-water) cooling types, the thermal capacity is given by:

$C = 0.06$ (core and coil assembly in lbs.) + 0.06 (tank and fittings in lbs.) + 1.93 (gallons of oil), Wh/°C; or

$C = 0.0272$ (weight of core and coil assembly in kg) + 0.0272 (weight of tank and fittings in kg) + 7.305 (L of oil), Wh/°C

For dry-type power transformers:

$C = 0.048 \times$ (weight of copper winding); or
 $C = 0.015 \times$ (weight of core and copper windings from the nameplate); or
 $C = 0.12 \times$ (weight of aluminum windings); or
 $C = 0.02 \times$ (weight of core and aluminum coils from the nameplate)

- **WINDING THERMAL TIME CONSTANT:** Required for insulation aging calculation. If this value is not available from the transformer data, select "2 min."

c) WINDINGS 1 TO 4

PATH: SETTINGS ⇌ SYSTEM SETUP ⇌ TRANSFORMER ⇌ WINDING 1(4)

■ WINDING 1	◀▶	WINDING 1 SOURCE: SRC 1	Range: SRC 1, SRC 2, SRC 3, SRC 4 (or the user-defined name)
MESSAGE	▲▼	WINDING 1 RATED MVA: 100.000 MVA	Range: 0.001 to 2000.000 MVA in steps of 0.001
MESSAGE	▲▼	WINDING 1 NOM ϕ - ϕ VOLTAGE: 220.000 kV	Range: 0.001 to 2000.000 kV in steps of 0.001
MESSAGE	▲▼	WINDING 1 CONNECTION: Wye	Range: Wye, Delta, Zig-zag
MESSAGE	▲▼	WINDING 1 GROUNDING: Not within zone	Range: Not within zone, Within zone
MESSAGE	▲▼	WINDING ~ ANGLE WRT WINDING 1: 0.0°	Range: -359.9 to 0.0° in steps of 0.1, ('~' > 1) (shown when viewed Winding is not Winding 1)
MESSAGE	▲	WINDING 1 RESISTANCE 3 ϕ : 10.0000 ohms	Range: 0.0001 to 100.0000 ohms in steps of 0.0001



The settings specific to each winding are shown above.

Transformer differential protection uses the following calculated quantities (per phase): fundamental, 2nd harmonic, and 5th harmonic differential current phasors, and restraint current phasors. This information is extracted from the current transformers (CTs) connected to the relay by correcting the magnitude and phase relationships of the currents for each winding, so as to obtain zero (or near zero) differential currents under normal operating conditions. Traditionally, these corrections were accomplished by interposing CTs and tapped relay windings with some combination of CT connections.

The T60 simplifies these configuration issues. All CTs at the transformer are connected Wye (polarity markings pointing away from the transformer). User-entered settings in the relay characterizing the transformer being protected and allow the relay to automatically perform all necessary magnitude, phase angle, and zero sequence compensation.

This section describes the algorithms in the relay that perform this compensation and produce the required calculated quantities for transformer differential protection, by means of the following example of a Δ -Y connected power transformer with the following data:

Table 5-4: EXAMPLE: Δ-Y CONNECTED POWER TRANSFORMER DATA

DATA	WINDING 1 Δ (DELTA) CONNECTION	WINDING 2 Y (WYE) CONNECTION
Voltage Phasor Diagram		
Phase Shift	0°	30° lag (i.e. phases of wye winding lag corresponding phases of delta winding by 30°)
Grounding	in-zone grounding bank	ungrounded
Rated MVA	100/133/166 MVA	100/133/166 MVA
Nominal ϕ - ϕ Voltage	220 kV	69 kV
CT Connection	Wye	Wye
CT Ratio	500/5	1500/5
Auxiliary Cooling	Two stages of forced air	Two stages of forced air

The abbreviated nomenclature for applicable relay settings is as follows:

Rotation	= SETTINGS ⇄ SYSTEM SETUP ⇄ POWER SYSTEM ⇄ PHASE ROTATION
w_{total}	= SETTINGS ⇄ SYSTEM SETUP ⇄ TRANSFORMER ⇄ GENERAL ⇄ NUMBER OF WINDINGS
Compensation	= SETTINGS ⇄ SYSTEM SETUP ⇄ TRANSFORMER ⇄ GENERAL ⇄ PHASE COMPENSATION
Source [w]	= SETTINGS ⇄ SYSTEM SETUP ⇄ TRANSFORMER ⇄ WINDING w ⇄ WINDING w SOURCE
P_{rated} [w]	= SETTINGS ⇄ SYSTEM SETUP ⇄ TRANSFORMER ⇄ WINDING w ⇄ WINDING w RATED MVA
$V_{nominal}$ [w]	= SETTINGS ⇄ SYSTEM SETUP ⇄ TRANSFORMER ⇄ WINDING w ⇄ WINDING w NOM ϕ - ϕ VOLTAGE
Connection [w]	= SETTINGS ⇄ SYSTEM SETUP ⇄ TRANSFORMER ⇄ WINDING w ⇄ WINDING w CONNECTION
Grounding [w]	= SETTINGS ⇄ SYSTEM SETUP ⇄ TRANSFORMER ⇄ WINDING w ⇄ WINDING w GROUNDING
Φ [w]	= SETTINGS ⇄ SYSTEM SETUP ⇄ TRANSFORMER ⇄ WINDING w ⇄ WINDING w ANGLE WRT WINDING 1
CT primary [w]	= the phase CT primary associated with Source [w]

Note that w = winding number, 1 to w_{total}

The following **transformer setup rules** must be observed:

1. The angle for the first winding from the transformer setup must be 0° and the angles for the following windings must be entered as negative (lagging) with respect to (WRT) the Winding 1 angle.
2. The “Within zone” and “Not within zone” setting values refer to whether the winding is grounded. Select “Within zone” if a neutral of a Wye type winding, or a corner of a Delta winding, is grounded within the zone, or whenever a grounding transformer falls into the zone of protection.

d) PHASE RELATIONSHIPS OF THREE-PHASE TRANSFORMERS

Power transformers that are built in accordance with ANSI and IEC standards are required to identify winding terminals and phase relationships among the windings of the transformer.

ANSI standard C.37.12.70 requires that the terminal labels include the characters 1, 2, 3 to represent the names of the individual phases. The phase relationship among the windings must be shown as a phasor diagram on the nameplate, with the winding terminals clearly labeled. This standard specifically states that the phase relationships are established for a condition where the source phase sequence of 1-2-3 is connected to transformer windings labeled 1, 2 and 3 respectively.

IEC standard 60076-1 (1993) states that the terminal markings of the three phases follow national practice. The phase relationship among the windings is shown as a specified notation on the nameplate, and there may be a phasor diagram. In this standard the arbitrary labeling of the windings is shown as I, II and III. This standard specifically states that the phase relationships are established for a condition where a source phase sequence of I-II-III is connected to transformer windings labeled I, II and III respectively.

The reason the source phase sequence must be stated when describing the winding phase relationships is that these relationships change when the phase sequence changes. The example shown below shows why this happens, using a transformer described in IEC nomenclature as a type “Yd1” or in GE Multilin nomenclature as a “Y/d30.”

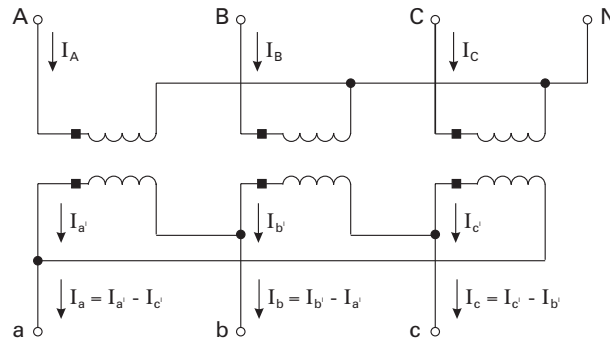

Figure 5-15: EXAMPLE TRANSFORMER

The above diagram shows the physical connections within the transformer that produce a phase angle in the delta winding that lag the respective wye winding by 30°. The currents in the windings are also identified. Note that the total current out of the delta winding is described by an equation. Now assume that a source, with a sequence of ABC, is connected to transformer terminals ABC respectively. The currents that would be present for a balanced load are shown the diagram below.

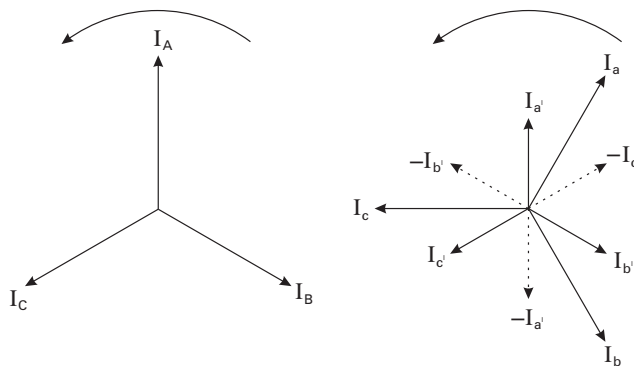

Figure 5-16: PHASORS FOR ABC SEQUENCE

Note that the delta winding currents lag the wye winding currents by 30° (in agreement with the transformer nameplate).

Now assume that a source, with a sequence of ACB is connected to transformer terminals A, C, and B, respectively. The currents present for a balanced load are shown in the Phasors for ACB Phase Sequence diagram.

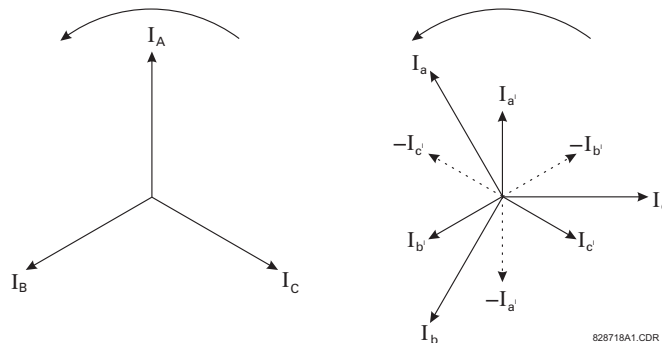

Figure 5-17: PHASORS FOR ACB SEQUENCE

Note that the delta winding currents leads the wye winding currents by 30°, (which is a type Yd11 in IEC nomenclature and a type Y/d330 in GE Multilin nomenclature) which is in disagreement with the transformer nameplate. This is because the physical connections and hence the equations used to calculate current for the delta winding have not changed. The transformer nameplate phase relationship information is only correct for a stated phase sequence.

It may be suggested that phase relationship for the ACB sequence can be returned the transformer nameplate values by connecting source phases A, B and C to transformer terminals A, C, and B respectively. Although this restores the nameplate phase shifts, it causes incorrect identification of phases B and C within the relay, and is therefore not recommended.

All information presented in this manual is based on connecting the relay phase A, B and C terminals to the power system phases A, B, and C respectively. The transformer types and phase relationships presented are for a system phase sequence of ABC, in accordance with the standards for power transformers. Users with a system phase sequence of ACB must determine the transformer type for this sequence.

If a power system with ACB rotation is connected to the Wye winding terminals 1, 2, and 3, respectively, from a Y/d30 transformer, select a Power Rotation setting of ACB into the relay and enter data for the Y/d30 transformer type.

e) MAGNITUDE COMPENSATION

Transformer protection presents problems in the application of current transformers. CTs should be matched to the current rating of each transformer winding, so that normal current through the power transformer is equal on the secondary side of the CT on different windings. However, because only standard CT ratios are available, this matching may not be exact.

In our example, the transformer has a voltage ratio of 220 kV / 69 kV (i.e. about 3.188 to 1) and a compensating CT ratio is 500 A to 1500 A (i.e. 1 to 3). Historically, this would have resulted in a steady state current at the differential relay. Interposing CTs or tapped relay windings were used to minimize this error.

The T60 automatically corrects for CT mismatch errors. All currents are magnitude compensated to be in units of the CTs of one winding before the calculation of differential and restraint quantities.

The reference winding (w_{ref}) is the winding to which all currents are referred. This means that the differential and restraint currents will be in per unit of nominal of the CTs on the reference winding. This is important to know, because the settings of the operate characteristic of the percent differential element (pickup, breakpoints 1 and 2) are entered in terms of the same per unit of nominal.

The reference winding is chosen by the relay to be the winding which has the smallest margin of CT primary current with respect to winding rated current, meaning that the CTs on the reference winding will most likely begin to saturate before those on other windings with heavy through currents. The characteristics of the reference winding CTs determine how the percent differential element operate characteristic should be set.

The T60 determines the reference winding as follows:

1. Calculate the rated current (I_{rated}) for each winding:

$$I_{rated}[w] = \frac{P_{rated}[w]}{\sqrt{3} \times V_{nom}[w]}, \text{ where } w = 1, 2, \dots, w_{total} \quad (\text{EQ 5.9})$$

Note: enter the self-cooled MVA rating for the P_{rated} setting.

2. Calculate the CT margin (I_{margin}) for each winding:

$$I_{margin} = \frac{\text{CT primary}[w]}{I_{rated}[w]}, \text{ where } w = 1, 2, \dots, w_{total} \quad (\text{EQ 5.10})$$

3. Choose the winding with the lowest CT margin:

In our example, the reference winding is chosen as follows.

1. Calculate the rated current for windings 1 and 2:

$$I_{rated}[1] = \frac{P_{rated}[1]}{\sqrt{3} \times V_{nom}[1]} = \frac{100 \text{ MVA}}{\sqrt{3} \times 220 \text{ kV}} = 226.4 \text{ A}, \quad I_{rated}[2] = \frac{P_{rated}[2]}{\sqrt{3} \times V_{nom}[2]} = \frac{100 \text{ MVA}}{\sqrt{3} \times 69 \text{ kV}} = 836.7 \text{ A} \quad (\text{EQ 5.11})$$

2. With these rated currents, calculate the CT margin for windings 1 and 2:

$$I_{margin}[1] = \frac{\text{CT primary}[1]}{I_{rated}[1]} = \frac{500 \text{ A}}{226.4 \text{ A}} = 1.91, \quad I_{margin}[2] = \frac{\text{CT primary}[2]}{I_{rated}[2]} = \frac{1500 \text{ A}}{836.7 \text{ A}} = 1.79 \quad (\text{EQ 5.12})$$

3. Since $I_{margin}[2] < I_{margin}[1]$, the reference winding w_{ref} is winding 2.

The reference winding is shown in **ACTUAL VALUES** ⇨ **METERING** ⇨ **TRANSFORMER** ⇨ **DIFFERENTIAL AND RESTRAINT** ⇨ **REFERENCE WINDING**.

The unit for calculation of the differential and restraint currents and base for the differential restraint settings is the CT primary associated with the reference winding. In this example, the unit CT is 1500:5 on winding 2.

Magnitude compensation factors (M) are the scaling values by which each winding current is multiplied to refer it to the reference winding. The T60 calculates magnitude compensation factors for each winding as follows:

$$M[w] = \frac{I_{primary}[w] \times V_{nom}[w]}{I_{primary}[w_{ref}] \times V_{nom}[w_{ref}]}, \text{ where } w = 1, 2, \dots, w_{total} \quad (\text{EQ 5.13})$$

In our example, the magnitude compensation factors are calculated as follows:

$$M[1] = \frac{I_{primary}[1] \times V_{nom}[1]}{I_{primary}[2] \times V_{nom}[2]} = \frac{500 \text{ A} \times 220 \text{ kV}}{1500 \text{ A} \times 69 \text{ kV}} = 1.0628 \quad (\text{EQ 5.14})$$

$$M[2] = \frac{I_{primary}[2] \times V_{nom}[2]}{I_{primary}[2] \times V_{nom}[2]} = \frac{1500 \text{ A} \times 69 \text{ kV}}{1500 \text{ A} \times 69 \text{ kV}} = 1.0000 \quad (\text{EQ 5.15})$$

The maximum allowed magnitude compensation factor (and hence the maximum allowed CT ratio mismatch) is 32.

f) PHASE AND ZERO SEQUENCE COMPENSATION

Power transformers may be connected to provide phase shift, such as the common Δ -Y connection with its 30° phase shift. Historically, CT connections were arranged to compensate for this phase error so that the relaying could operate correctly.

In our example, the transformer has the Δ -Y connection. Traditionally, CTs on the Wye connected transformer winding (winding 2) would be connected in a delta arrangement, which compensates for the phase angle lag introduced in the Delta connected winding (winding 1), so that line currents from both windings can be compared at the relay. The Delta connection of CTs, however, inherently has the effect of removing the zero sequence components of the phase currents. If there were a grounding bank on the Delta winding of the power transformer within the zone of protection, a ground fault would result in differential (zero sequence) current and false trips. In such a case, it would be necessary to insert a zero sequence current trap with the Wye connected CTs on the Delta winding of the transformer.

In general, zero sequence removal is necessary if zero sequence can flow into and out of one transformer winding but not the other winding. Transformer windings that are grounded inside the zone of protection allow zero sequence current flow in that winding, and therefore it is from these windings that zero sequence removal is necessary.

The T60 performs this phase angle compensation and zero sequence removal automatically, based on the settings entered for the transformer. All CTs are connected Wye (polarity markings pointing away from the transformer). All currents are phase and zero sequence compensated internally before the calculation of differential and restraint quantities.

The phase reference winding (w_f) is the winding which will have a phase shift of 0° applied to it. The phase reference winding is chosen to be the delta or zigzag (non-wye) winding with the lowest winding index, if one exists. For a transformer that has no delta or zigzag windings, the first winding is chosen.

The phase compensation angle (Φ_{comp}), the angle by which a winding current is shifted to refer it to the phase reference winding, is calculated by the T60 for each winding as follows:

$$\Phi_{comp}[w] = |\Phi[w_f] - \Phi[w]| \text{ where Rotation} = \text{"ABC"}$$

$$\Phi_{comp}[w] = |\Phi[w] - \Phi[w_f]| \text{ where Rotation} = \text{"ACB"}$$

In our example, the phase reference winding would be winding 1, the first delta winding (i.e. $w_f = 1$). The phase compensation angle for each winding would then be calculated as follows (assuming Rotation = "ABC"):

$$\Phi_{comp}[1] = 0^\circ - 0^\circ = 0^\circ$$

$$\Phi_{comp}[2] = 0^\circ - (-30^\circ) = 30^\circ = 330^\circ \text{ lag}$$

The following table shows the linear combination of phases of a transformer winding that achieves the phase shift and zero sequence removal for typical values of Φ_{comp} :

where: $I_A[w]$ = uncompensated winding 'w' phase A current

$I_A^p[w]$ = phase and zero sequence compensated winding 'w' phase A current

Table 5-5: PHASE AND ZERO SEQUENCE COMPENSATION FOR TYPICAL VALUES OF Φ_{comp}

$\Phi_{comp}[W]$	Grounding[W] = "Not within zone"	Grounding[W] = "Within zone"
0°	$I_A^p[W] = I_A[W]$ $I_B^p[W] = I_B[W]$ $I_C^p[W] = I_C[W]$	$I_A^p[W] = \frac{2}{3}I_A[W] - \frac{1}{3}I_B[W] - \frac{1}{3}I_C[W]$ $I_B^p[W] = \frac{2}{3}I_B[W] - \frac{1}{3}I_A[W] - \frac{1}{3}I_C[W]$ $I_C^p[W] = \frac{2}{3}I_C[W] - \frac{1}{3}I_A[W] - \frac{1}{3}I_B[W]$
30° lag	$I_A^p[W] = \frac{1}{\sqrt{3}}I_A[W] - \frac{1}{\sqrt{3}}I_C[W]$ $I_B^p[W] = \frac{1}{\sqrt{3}}I_B[W] - \frac{1}{\sqrt{3}}I_A[W]$ $I_C^p[W] = \frac{1}{\sqrt{3}}I_C[W] - \frac{1}{\sqrt{3}}I_B[W]$	$I_A^p[W] = \frac{1}{\sqrt{3}}I_A[W] - \frac{1}{\sqrt{3}}I_C[W]$ $I_B^p[W] = \frac{1}{\sqrt{3}}I_B[W] - \frac{1}{\sqrt{3}}I_A[W]$ $I_C^p[W] = \frac{1}{\sqrt{3}}I_C[W] - \frac{1}{\sqrt{3}}I_B[W]$
60° lag	$I_A^p[W] = -I_C[W],$ $I_B^p[W] = -I_A[W],$ $I_C^p[W] = -I_B[W]$	$I_A^p[W] = -\frac{2}{3}I_C[W] + \frac{1}{3}I_A[W] + \frac{1}{3}I_B[W]$ $I_B^p[W] = -\frac{2}{3}I_A[W] + \frac{1}{3}I_B[W] + \frac{1}{3}I_C[W]$ $I_C^p[W] = -\frac{2}{3}I_B[W] + \frac{1}{3}I_A[W] + \frac{1}{3}I_C[W]$
90° lag	$I_A^p[W] = \frac{1}{\sqrt{3}}I_B[W] - \frac{1}{\sqrt{3}}I_C[W]$ $I_B^p[W] = \frac{1}{\sqrt{3}}I_C[W] - \frac{1}{\sqrt{3}}I_A[W]$ $I_C^p[W] = \frac{1}{\sqrt{3}}I_A[W] - \frac{1}{\sqrt{3}}I_B[W]$	$I_A^p[W] = \frac{1}{\sqrt{3}}I_B[W] - \frac{1}{\sqrt{3}}I_C[W]$ $I_B^p[W] = \frac{1}{\sqrt{3}}I_C[W] - \frac{1}{\sqrt{3}}I_A[W]$ $I_C^p[W] = \frac{1}{\sqrt{3}}I_A[W] - \frac{1}{\sqrt{3}}I_B[W]$
120° lag	$I_A^p[W] = I_B[W]$ $I_B^p[W] = I_C[W]$ $I_C^p[W] = I_A[W]$	$I_A^p[W] = \frac{2}{3}I_B[W] - \frac{1}{3}I_A[W] - \frac{1}{3}I_C[W]$ $I_B^p[W] = \frac{2}{3}I_C[W] - \frac{1}{3}I_A[W] - \frac{1}{3}I_B[W]$ $I_C^p[W] = \frac{2}{3}I_A[W] - \frac{1}{3}I_B[W] - \frac{1}{3}I_C[W]$
150° lag	$I_A^p[W] = \frac{1}{\sqrt{3}}I_B[W] - \frac{1}{\sqrt{3}}I_A[W]$ $I_B^p[W] = \frac{1}{\sqrt{3}}I_C[W] - \frac{1}{\sqrt{3}}I_B[W]$ $I_C^p[W] = \frac{1}{\sqrt{3}}I_A[W] - \frac{1}{\sqrt{3}}I_C[W]$	$I_A^p[W] = \frac{1}{\sqrt{3}}I_B[W] - \frac{1}{\sqrt{3}}I_A[W]$ $I_B^p[W] = \frac{1}{\sqrt{3}}I_C[W] - \frac{1}{\sqrt{3}}I_B[W]$ $I_C^p[W] = \frac{1}{\sqrt{3}}I_A[W] - \frac{1}{\sqrt{3}}I_C[W]$
180° lag	$I_A^p[W] = -I_A[W]$ $I_B^p[W] = -I_B[W]$ $I_C^p[W] = -I_C[W]$	$I_A^p[W] = -\frac{2}{3}I_A[W] + \frac{1}{3}I_B[W] + \frac{1}{3}I_C[W]$ $I_B^p[W] = -\frac{2}{3}I_B[W] + \frac{1}{3}I_A[W] + \frac{1}{3}I_C[W]$ $I_C^p[W] = -\frac{2}{3}I_C[W] + \frac{1}{3}I_A[W] + \frac{1}{3}I_B[W]$
210° lag	$I_A^p[W] = \frac{1}{\sqrt{3}}I_C[W] - \frac{1}{\sqrt{3}}I_A[W]$ $I_B^p[W] = \frac{1}{\sqrt{3}}I_A[W] - \frac{1}{\sqrt{3}}I_B[W]$ $I_C^p[W] = \frac{1}{\sqrt{3}}I_B[W] - \frac{1}{\sqrt{3}}I_C[W]$	$I_A^p[W] = \frac{1}{\sqrt{3}}I_C[W] - \frac{1}{\sqrt{3}}I_A[W]$ $I_B^p[W] = \frac{1}{\sqrt{3}}I_A[W] - \frac{1}{\sqrt{3}}I_B[W]$ $I_C^p[W] = \frac{1}{\sqrt{3}}I_B[W] - \frac{1}{\sqrt{3}}I_C[W]$

Table 5–5: PHASE AND ZERO SEQUENCE COMPENSATION FOR TYPICAL VALUES OF Φ_{comp}

$\Phi_{comp}[W]$	Grounding[W] = “Not within zone”	Grounding[W] = “Within zone”
240° lag	$I_A^P[W] = I_C[W]$ $I_B^P[W] = I_A[W]$ $I_C^P[W] = I_B[W]$	$I_A^P[W] = \frac{2}{3}I_C[W] - \frac{1}{3}I_A[W] - \frac{1}{3}I_B[W]$ $I_B^P[W] = \frac{2}{3}I_A[W] - \frac{1}{3}I_B[W] - \frac{1}{3}I_C[W]$ $I_C^P[W] = \frac{2}{3}I_B[W] - \frac{1}{3}I_A[W] - \frac{1}{3}I_C[W]$
270° lag	$I_A^P[W] = \frac{1}{\sqrt{3}}I_C[W] - \frac{1}{\sqrt{3}}I_B[W]$ $I_B^P[W] = \frac{1}{\sqrt{3}}I_A[W] - \frac{1}{\sqrt{3}}I_C[W]$ $I_C^P[W] = \frac{1}{\sqrt{3}}I_B[W] - \frac{1}{\sqrt{3}}I_A[W]$	$I_A^P[W] = \frac{1}{\sqrt{3}}I_C[W] - \frac{1}{\sqrt{3}}I_B[W]$ $I_B^P[W] = \frac{1}{\sqrt{3}}I_A[W] - \frac{1}{\sqrt{3}}I_C[W]$ $I_C^P[W] = \frac{1}{\sqrt{3}}I_B[W] - \frac{1}{\sqrt{3}}I_A[W]$
300° lag	$I_A^P[W] = -I_B[W]$ $I_B^P[W] = -I_C[W]$ $I_C^P[W] = -I_A[W]$	$I_A^P[W] = -\frac{2}{3}I_B[W] + \frac{1}{3}I_A[W] + \frac{1}{3}I_C[W]$ $I_B^P[W] = -\frac{2}{3}I_C[W] + \frac{1}{3}I_A[W] + \frac{1}{3}I_B[W]$ $I_C^P[W] = -\frac{2}{3}I_A[W] + \frac{1}{3}I_B[W] + \frac{1}{3}I_C[W]$
330° lag	$I_A^P[W] = \frac{1}{\sqrt{3}}I_A[W] - \frac{1}{\sqrt{3}}I_B[W]$ $I_B^P[W] = \frac{1}{\sqrt{3}}I_B[W] - \frac{1}{\sqrt{3}}I_C[W]$ $I_C^P[W] = \frac{1}{\sqrt{3}}I_C[W] - \frac{1}{\sqrt{3}}I_A[W]$	$I_A^P[W] = \frac{1}{\sqrt{3}}I_A[W] - \frac{1}{\sqrt{3}}I_B[W]$ $I_B^P[W] = \frac{1}{\sqrt{3}}I_B[W] - \frac{1}{\sqrt{3}}I_C[W]$ $I_C^P[W] = \frac{1}{\sqrt{3}}I_C[W] - \frac{1}{\sqrt{3}}I_A[W]$

In our example, the following phase and zero-sequence compensation equations would be used:

For Winding 1:

$$I_A^P[1] = \frac{2}{3}I_A[1] - \frac{1}{3}I_B[1] - \frac{1}{3}I_C[1]; \quad I_B^P[1] = \frac{2}{3}I_B[1] - \frac{1}{3}I_A[1] - \frac{1}{3}I_C[1]; \quad I_C^P[1] = \frac{2}{3}I_C[1] - \frac{1}{3}I_A[1] - \frac{1}{3}I_B[1] \quad (\text{EQ 5.16})$$

For Winding 2:

$$I_A^P[W] = \frac{1}{\sqrt{3}}I_A[2] - \frac{1}{\sqrt{3}}I_B[2]; \quad I_B^P[W] = \frac{1}{\sqrt{3}}I_B[2] - \frac{1}{\sqrt{3}}I_C[2]; \quad I_C^P[W] = \frac{1}{\sqrt{3}}I_C[2] - \frac{1}{\sqrt{3}}I_A[2] \quad (\text{EQ 5.17})$$

g) MAGNITUDE, PHASE ANGLE, AND ZERO SEQUENCE COMPENSATION

La compensation complète de magnitude d'angle de phase et zéro séquence est comme suit:

$$I_A^C[W] = M[W] \times I_A^P[W], \quad \text{où } w = 1, 2, \dots, w_{total} \quad (\text{EQ 5.18})$$

$$I_B^C[W] = M[W] \times I_B^P[W], \quad \text{où } w = 1, 2, \dots, w_{total} \quad (\text{EQ 5.19})$$

$$I_C^C[W] = M[W] \times I_C^P[W], \quad \text{où } w = 1, 2, \dots, w_{total} \quad (\text{EQ 5.20})$$

où: $I_A^C[W]$, $I_B^C[W]$, et $I_C^C[W]$ = enroulement compensé en magnitude, en phase et en composante homopolaire «w» courant phase A; $M[W]$ = facteur de compensation de magnitude pour l'enroulement «w» (tel que calculé); $I_A^P[W]$, $I_B^P[W]$, et $I_C^P[W]$ = enroulement compensé en phase et en composante homopolaire «w», courant phase A (tel que calculé)

h) DIFFERENTIAL AND RESTRAINT CURRENT CALCULATIONS

Differential and restraint currents are calculated as follows:

$$I_{d_A} = I_A^C[1] + I_A^C[2] + \dots + I_A^C[w_{total}] \quad (\text{EQ 5.21})$$

$$I_{d_B} = I_B^C[1] + I_B^C[2] + \dots + I_B^C[w_{total}] \quad (\text{EQ 5.22})$$

$$I_{d_C} = I_C^C[1] + I_C^C[2] + \dots + I_C^C[w_{total}] \quad (\text{EQ 5.23})$$

$$I_{r_A} = \max(|I_A^C[1]|, |I_A^C[2]|, \dots, |I_A^C[w_{total}]|) \quad (\text{EQ 5.24})$$

$$I_{r_B} = \max(|I_B^C[1]|, |I_B^C[2]|, \dots, |I_B^C[w_{total}]|) \quad (\text{EQ 5.25})$$

$$I_{r_C} = \max(|I_C^C[1]|, |I_C^C[2]|, \dots, |I_C^C[w_{total}]|) \quad (\text{EQ 5.26})$$

where I_{d_A} , I_{d_B} , and I_{d_C} are the phase differential currents and I_{r_A} , I_{r_B} , and I_{r_C} are the phase restraint currents.

i) TRANSFORMER WINDINGS BETWEEN TWO BREAKERS

When the relay is to protect a transformer with windings connected between two breakers, such as in a ring bus or breaker-and-a-half station configuration, one of the methods for configuring currents into the relay presented below should be used (see the Breaker-and-a-Half Scheme diagram in the Overview section of this chapter).

For this example it is assumed that winding 1 is connected between two breakers and winding 2 is connected to a single breaker. The CTs associated with winding 1 are CTX, at 1200/5 A and CTY, at 1000/5 A. CTX is connected to current input channels 1 through 3 inclusive and CTY is connected to current input channels 5 through 7 inclusive on a type 8H CT/VT module in relay slot "F." The CT2 on winding 2 is 5000/5 A and is connected to current input channels 1 through 4 inclusive on a type 8F CT/VT module in relay slot "M".

SETUP METHOD A (PREFERRED)

This approach is preferred because it provides increased sensitivity as the current from each individual set of CTs participates directly in the calculation of CT ratio mismatch, phase compensation, zero-sequence removal (if required) and the differential restraint current. The concept used in this approach is to consider that each set of CTs connected to winding 1 represents a connection to an individual winding. For our example we consider the two-winding transformer to be a three-winding transformer.

1. Enter the settings for each set of CTs in the **SYSTEM SETUP** ⇒ **AC INPUTS** ⇒ **CURRENT BANK** settings menu.

PHASE CT F1 PRIMARY: "1200 A"
PHASE CT F1 SECONDARY: "5 A"
GROUND CT F1 PRIMARY: "1 A" (default value)
GROUND CT F1 SECONDARY: "1 A" (default value)

PHASE CT F5 PRIMARY: "1000 A"
PHASE CT F5 SECONDARY: "5 A"
GROUND CT F5 PRIMARY: "1 A" (default value)
GROUND CT F5 SECONDARY: "1 A" (default value)

PHASE CT M1 PRIMARY: "5000 A"
PHASE CT M1 SECONDARY: "5 A"
GROUND CT M5 PRIMARY: "5000 A"
GROUND CT M5 SECONDARY: "5 A"

2. Configure Source n (Source 1 for this example) as the current from CTX in Winding 1 in the **SYSTEM SETUP** ⇒ **SIGNAL SOURCES** ⇒ **SOURCE n** settings menu.

SOURCE 1 NAME: "WDG 1X"
SOURCE 1 PHASE CT: "F1"
SOURCE 1 GROUND CT: "None"
SOURCE 1 PHASE VT: "None"
SOURCE 1 AUX VT: "None"

3. Configure Source n (Source 2 for this example) as the current from CTY in Winding 1 in the **SYSTEM SETUP** ⇒⇩ **SIGNAL SOURCES** ⇒⇩ **SOURCE n** settings menu.
 - SOURCE 2 NAME:** "WDG 1Y"
 - SOURCE 2 PHASE CT:** "F5"
 - SOURCE 2 GROUND CT:** "None"
 - SOURCE 2 PHASE VT:** "None"
 - SOURCE 2 AUX VT:** "None"
4. Configure Source n (Source 3 for this example) to be used as the current in Winding 2 in the **SYSTEM SETUP** ⇒⇩ **SIGNAL SOURCES** ⇒⇩ **SOURCE n** settings menu.
 - SOURCE 3 NAME:** "WDG 2"
 - SOURCE 3 PHASE CT:** "M1"
 - SOURCE 3 GROUND CT:** "M1"
 - SOURCE 3 PHASE VT:** "None"
 - SOURCE 3 AUX VT:** "None"
5. Configure the Source setting of the transformer windings in the **SYSTEM SETUP** ⇒⇩ **TRANSFORMER** ⇒⇩ **WINDING n** settings menu.
 - WINDING 1 SOURCE:** "WDG 1X"
 - WINDING 2 SOURCE:** "WDG 1Y"
 - WINDING 3 SOURCE:** "WDG 2"

SETUP METHOD B (ALTERNATE)

This approach adds the current from each phase of the CT1 and CT2 together to represent the total winding 1 current. The procedure is shown below.

1. Enter the settings for each set of CTs in the **SYSTEM SETUP** ⇒ **AC INPUTS** ⇒ **CURRENT BANK** settings menu, as shown for Method A above.
2. Configure Source n (Source 1 for this example) to be used as the summed current in Winding 1 in the **SYSTEM SETUP** ⇒⇩ **SIGNAL SOURCES** ⇒⇩ **SOURCE n** settings menu.
 - SOURCE 1 NAME:** "WDG 1"
 - SOURCE 1 PHASE CT:** "F1 + F5"
 - SOURCE 1 GROUND CT:** "None"
 - SOURCE 1 PHASE VT:** "None"
 - SOURCE 1 AUX VT:** "None"
3. Configure Source n (Source 2 for this example) to be used as the Winding 2 current in the **SYSTEM SETUP** ⇒⇩ **SIGNAL SOURCES** ⇒⇩ **SOURCE n** settings menu.
 - SOURCE 2 NAME:** "WDG 2"
 - SOURCE 2 PHASE CT:** "M1"
 - SOURCE 2 GROUND CT:** "M1"
 - SOURCE 2 PHASE VT:** "None"
 - SOURCE 2 AUX VT:** "None"

j) TRANSFORMER THERMAL INPUTS

PATH: SETTINGS ⇨ ↓ SYSTEM SETUP ⇨ ↓ TRANSFORMER ⇨ ↓ THERMAL INPUTS

<div style="display: flex; justify-content: space-between;"> ■ THERMAL INPUTS ◀▶ </div>	<div style="display: flex; justify-content: space-between;"> WINDING CURRENTS: Range: SRC 1, SRC 2, SRC 3, SRC 4 (or the user-defined name) </div> <div style="border: 1px solid black; padding: 2px;">SRC 1</div>
MESSAGE	<div style="display: flex; justify-content: space-between;"> ▲ ▼ </div> <div style="display: flex; justify-content: space-between;"> AMBIENT TEMPERATURE: Range: RTD Input 1,... RTD Input 8, dcmA Input 1,..., dcmA Input 8, Monthly Average </div> <div style="border: 1px solid black; padding: 2px;">RTD Input 1</div>
MESSAGE	<div style="display: flex; justify-content: space-between;"> ▲ </div> <div style="display: flex; justify-content: space-between;"> TOP-OIL TEMPERATURE: Range: RTD Input 1,... RTD Input 8, dcmA Input 1,..., dcmA Input 8, Computed </div> <div style="border: 1px solid black; padding: 2px;">RTD Input 1</div>

The thermal inputs settings are used for computation of hottest-spot winding temperature, aging factor and accumulated loss of life.

- WINDING CURRENTS:** Enter a source that represents the true winding load currents.
 - 
NOTE In cases where two or more sets of CTs are associated to the winding and where thermal elements are to be set (for example, in a breaker-and-a-half scheme), a spare source for current summation from these CTs should be used to obtain the total true winding current. Otherwise, select the only source representing the other winding current.
- AMBIENT TEMPERATURE:** Select an RTD or dcmA input if the ambient temperature is to be measured directly. Otherwise, select “Monthly Average” and enter an average temperature for each month of the year if a directly measured device output is not available (see monthly settings below).
- TOP OIL TEMPERATURE:** Select RTD or dcmA input for direct measurement of top-oil temperature. If an RTD or dcmA input is not available, select the “Computed”.

The following menu will be available when **AMBIENT TEMPERATURE** is “Monthly Average”.

PATH: SETTINGS ⇨ ↓ SYSTEM SETUP ⇨ ↓ TRANSFORMER ⇨ ↓ THERMAL INPUTS ⇨ AMBIENT TEMPERATURE

<div style="display: flex; justify-content: space-between;"> AMBIENT TEMPERATURE: ◀▶ </div> <div style="border: 1px solid black; padding: 2px;">Monthly Average</div>	<div style="display: flex; justify-content: space-between;"> JANUARY AVERAGE: Range: -60 to 60°C in steps of 1 </div> <div style="border: 1px solid black; padding: 2px;">-20°C</div>
MESSAGE	<div style="display: flex; justify-content: space-between;"> ▲ ▼ </div> <div style="display: flex; justify-content: space-between;"> FEBRUARY AVERAGE: Range: -60 to 60°C in steps of 1 </div> <div style="border: 1px solid black; padding: 2px;">-30°C</div>
MESSAGE	<div style="display: flex; justify-content: space-between;"> ▲ </div> <div style="display: flex; justify-content: space-between;"> MARCH AVERAGE: Range: -60 to 60°C in steps of 1 </div> <div style="border: 1px solid black; padding: 2px;">-10°C</div>
↓	
MESSAGE	<div style="display: flex; justify-content: space-between;"> ▲ </div> <div style="display: flex; justify-content: space-between;"> DECEMBER AVERAGE: Range: -60 to 60°C in steps of 1 </div> <div style="border: 1px solid black; padding: 2px;">-10°C</div>

5.3.5 FLEXCURVES™

a) SETTINGS

PATH: SETTINGS ⇌ SYSTEM SETUP ⇌ FLEXCURVES ⇌ FLEXCURVE A(D)

 FLEXCURVE A

 FLEXCURVE A TIME AT
 0.00 xPKP: 0 ms

Range: 0 to 65535 ms in steps of 1

FlexCurves™ A through D have settings for entering times to Reset/Operate at the following pickup levels: 0.00 to 0.98 / 1.03 to 20.00. This data is converted into 2 continuous curves by linear interpolation between data points. To enter a custom FlexCurve™, enter the Reset/Operate time (using the ▲ VALUE ▼ keys) for each selected pickup point (using the ▲ MESSAGE ▼ keys) for the desired protection curve (A, B, C, or D).

Table 5–6: FLEXCURVE™ TABLE

RESET	TIME MS	RESET	TIME MS	OPERATE	TIME MS	OPERATE	TIME MS	OPERATE	TIME MS	OPERATE	TIME MS
0.00		0.68		1.03		2.9		4.9		10.5	
0.05		0.70		1.05		3.0		5.0		11.0	
0.10		0.72		1.1		3.1		5.1		11.5	
0.15		0.74		1.2		3.2		5.2		12.0	
0.20		0.76		1.3		3.3		5.3		12.5	
0.25		0.78		1.4		3.4		5.4		13.0	
0.30		0.80		1.5		3.5		5.5		13.5	
0.35		0.82		1.6		3.6		5.6		14.0	
0.40		0.84		1.7		3.7		5.7		14.5	
0.45		0.86		1.8		3.8		5.8		15.0	
0.48		0.88		1.9		3.9		5.9		15.5	
0.50		0.90		2.0		4.0		6.0		16.0	
0.52		0.91		2.1		4.1		6.5		16.5	
0.54		0.92		2.2		4.2		7.0		17.0	
0.56		0.93		2.3		4.3		7.5		17.5	
0.58		0.94		2.4		4.4		8.0		18.0	
0.60		0.95		2.5		4.5		8.5		18.5	
0.62		0.96		2.6		4.6		9.0		19.0	
0.64		0.97		2.7		4.7		9.5		19.5	
0.66		0.98		2.8		4.8		10.0		20.0	



The relay using a given FlexCurve™ applies linear approximation for times between the user-entered points. Special care must be applied when setting the two points that are close to the multiple of pickup of 1, i.e. 0.98 pu and 1.03 pu. It is recommended to set the two times to a similar value; otherwise, the linear approximation may result in undesired behavior for the operating quantity that is close to 1.00 pu.

b) FLEXCURVE™ CONFIGURATION WITH ENERVISTA UR SETUP

The EnerVista UR Setup software allows for easy configuration and management of FlexCurves™ and their associated data points. Prospective FlexCurves™ can be configured from a selection of standard curves to provide the best approximate fit, then specific data points can be edited afterwards. Alternately, curve data can be imported from a specified file (.csv format) by selecting the **Import Data From** EnerVista UR Setup setting.

Curves and data can be exported, viewed, and cleared by clicking the appropriate buttons. FlexCurves™ are customized by editing the operating time (ms) values at pre-defined per-unit current multiples. Note that the pickup multiples start at zero (implying the "reset time"), operating time below pickup, and operating time above pickup.

c) RECLOSER CURVE EDITING

Recloser Curve selection is special in that recloser curves can be shaped into a composite curve with a minimum response time and a fixed time above a specified pickup multiples. There are 41 recloser curve types supported. These definite operating times are useful to coordinate operating times, typically at higher currents and where upstream and downstream protective devices have different operating characteristics. The Recloser Curve configuration window shown below appears when the Initialize From EnerVista UR Setup setting is set to "Recloser Curve" and the Initialize FlexCurve button is clicked.

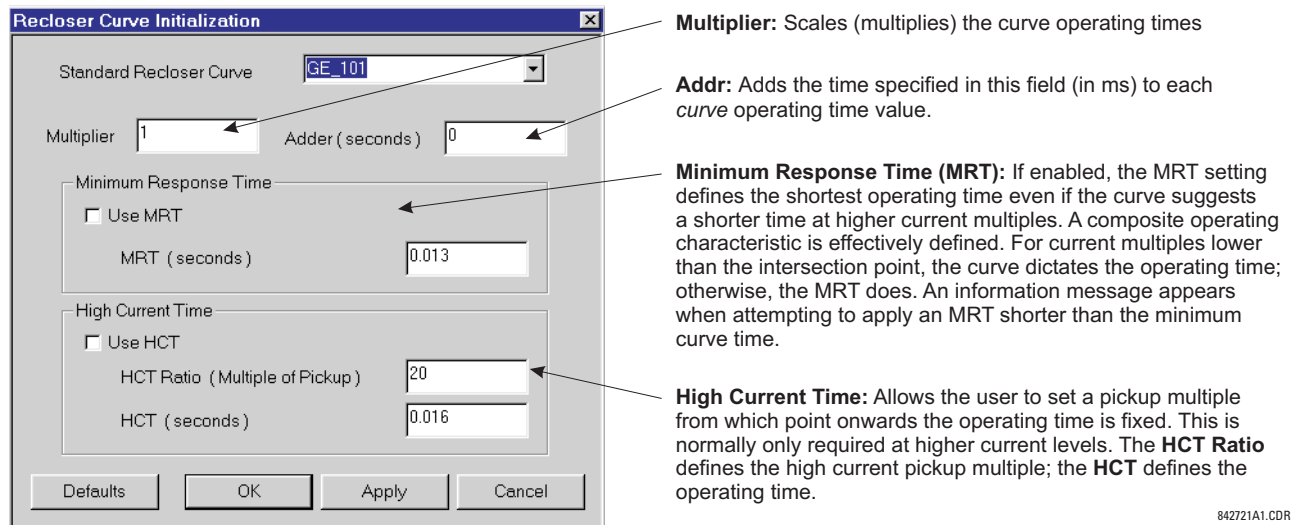

Figure 5–18: RECLOSER CURVE INITIALIZATION



Multiplier and Adder settings only affect the curve portion of the characteristic and not the MRT and HCT settings. The HCT settings override the MRT settings for multiples of pickup greater than the HCT Ratio.

d) EXAMPLE

A composite curve can be created from the GE_111 standard with MRT = 200 ms and HCT initially disabled and then enabled at 8 times pickup with an operating time of 30 ms. At approximately 4 times pickup, the curve operating time is equal to the MRT and from then onwards the operating time remains at 200 ms (see below).

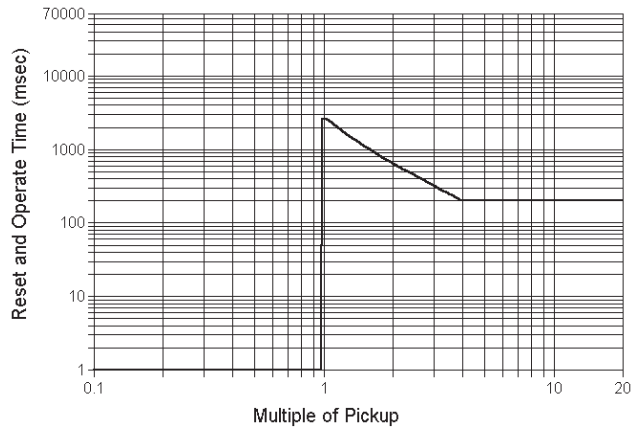
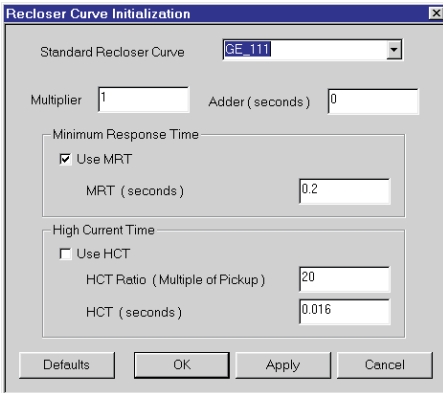

842719A1.CDR

Figure 5–19: COMPOSITE RECLOSER CURVE WITH HCT DISABLED

With the HCT feature enabled, the operating time reduces to 30 ms for pickup multiples exceeding 8 times pickup.

5

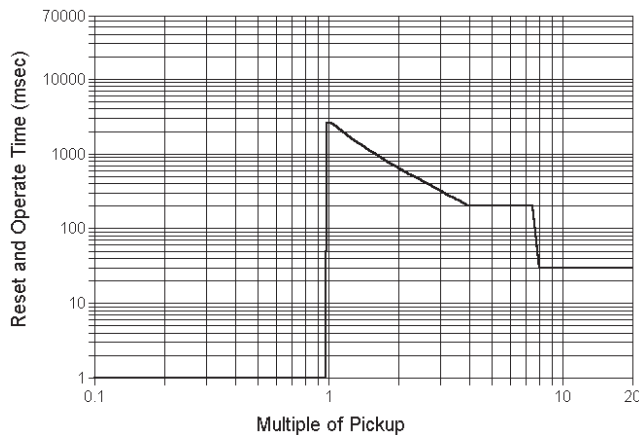
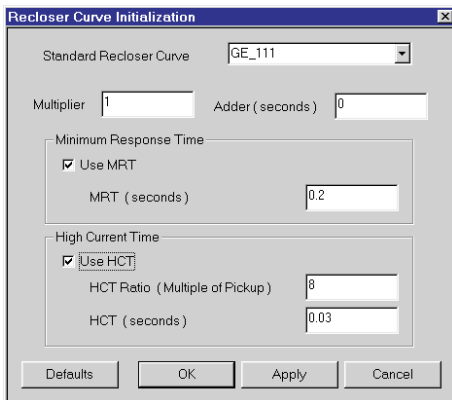

842720A1.CDR

Figure 5–20: COMPOSITE RECLOSER CURVE WITH HCT ENABLED



Configuring a composite curve with an increase in operating time at increased pickup multiples is not allowed. If this is attempted, the EnerVista UR Setup software generates an error message and discards the proposed changes.

e) STANDARD RECLOSER CURVES

The standard Recloser curves available for the T60 are displayed in the following graphs.

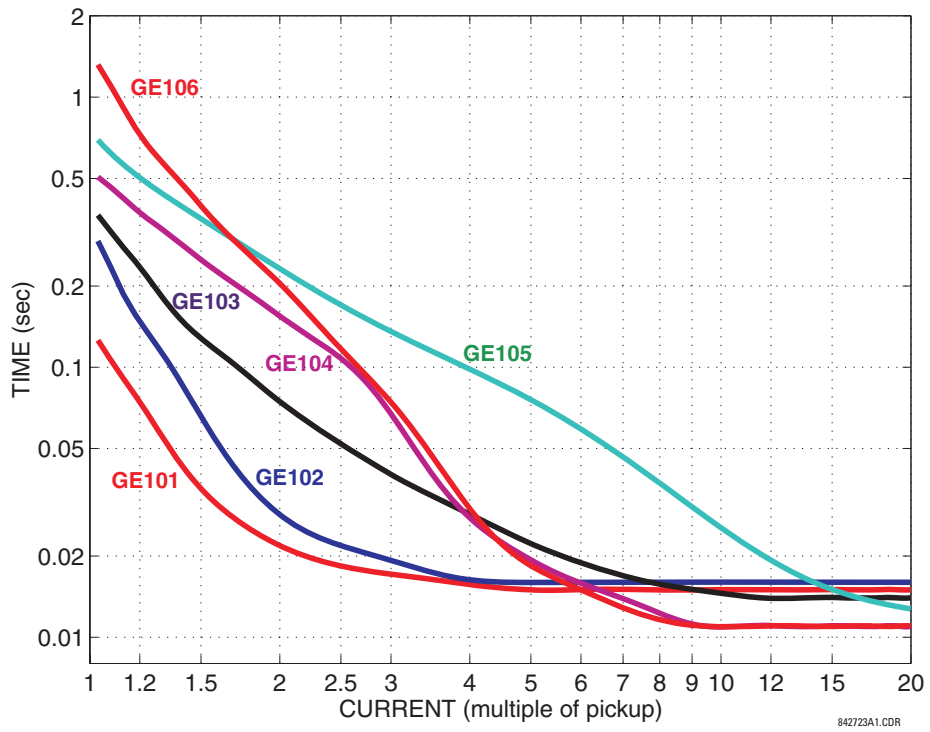

Figure 5-21: RECLOSER CURVES GE101 TO GE106

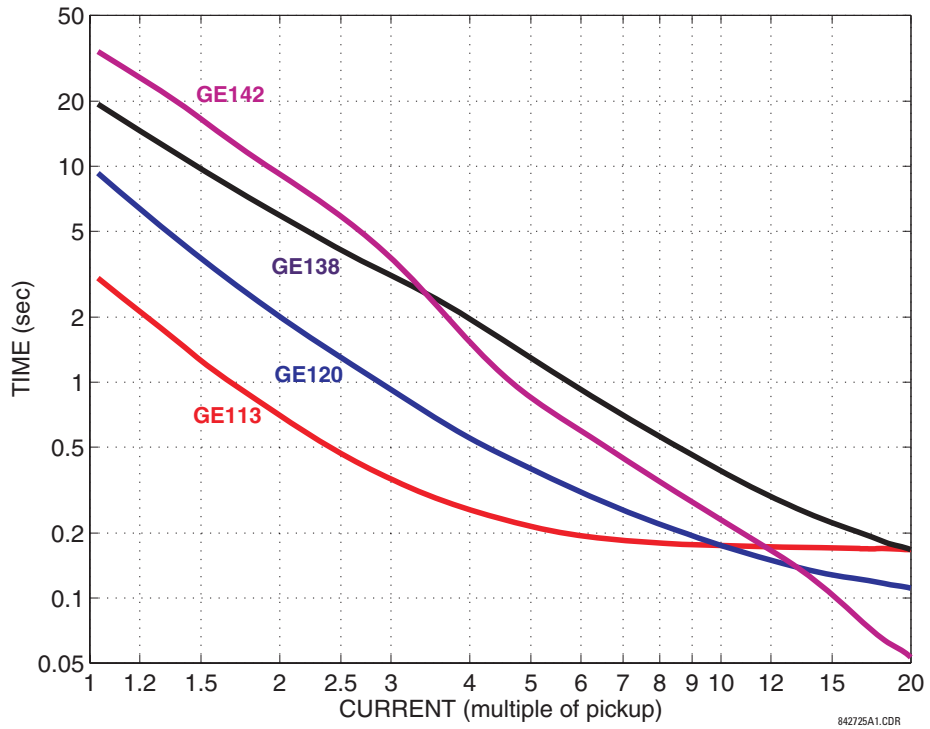

Figure 5-22: RECLOSER CURVES GE113, GE120, GE138 AND GE142

5

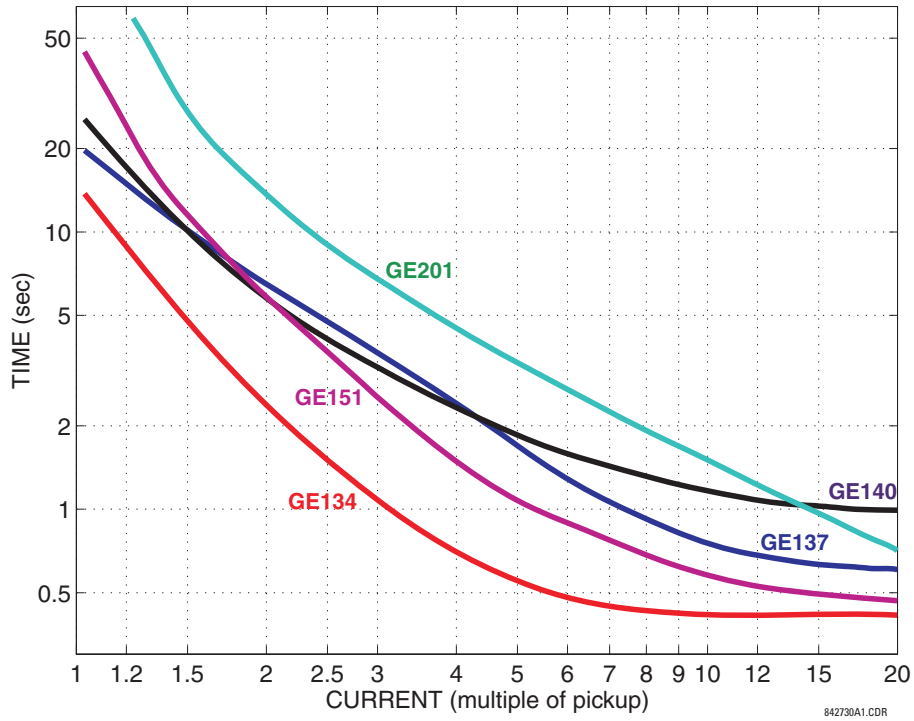

Figure 5-23: RECLOSER CURVES GE134, GE137, GE140, GE151 AND GE201

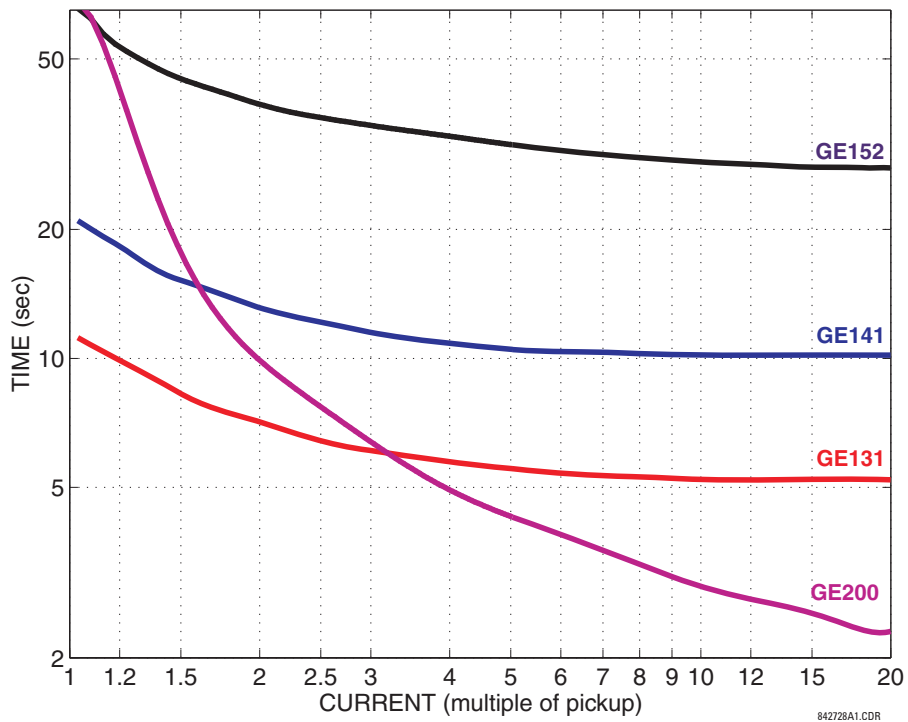

Figure 5-24: RECLOSER CURVES GE131, GE141, GE152, AND GE200

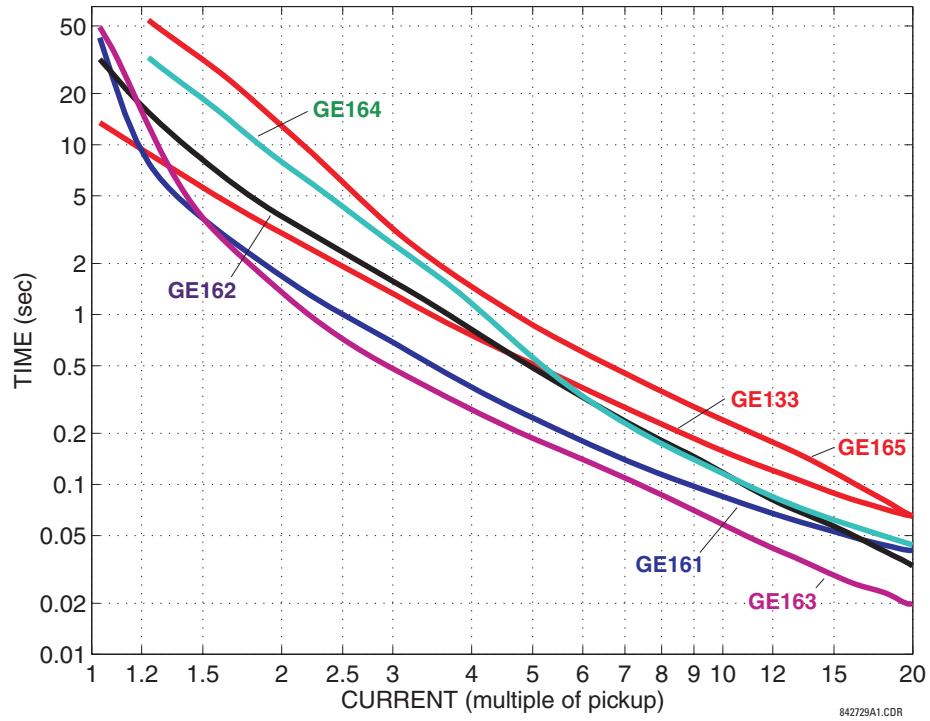

Figure 5–25: RECLOSER CURVES GE133, GE161, GE162, GE163, GE164 AND GE165

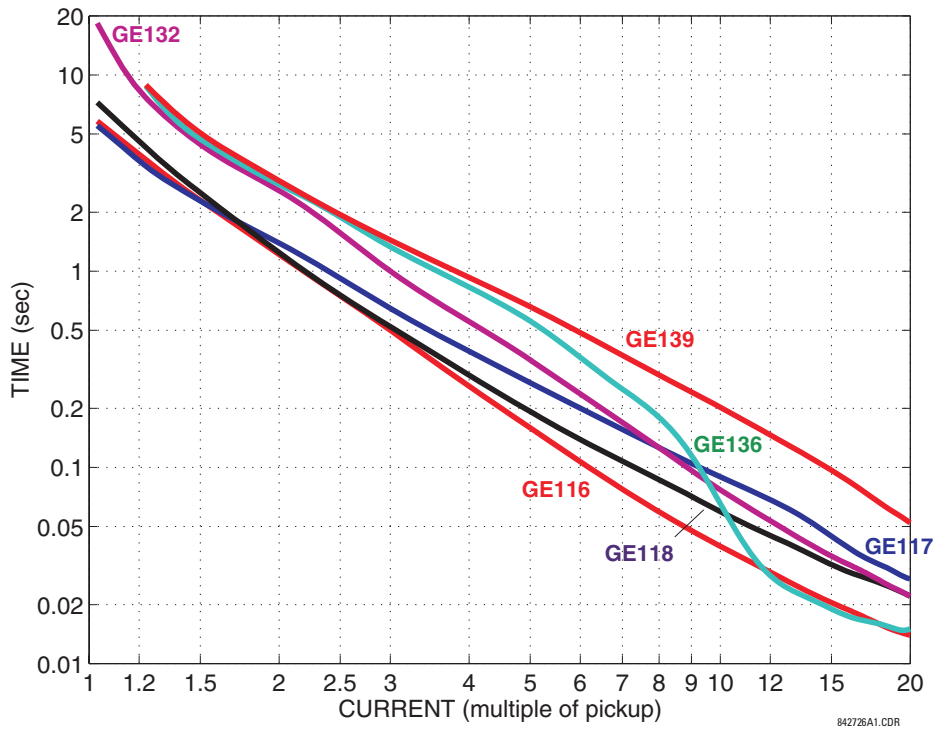

Figure 5–26: RECLOSER CURVES GE116, GE117, GE118, GE132, GE136, AND GE139

5

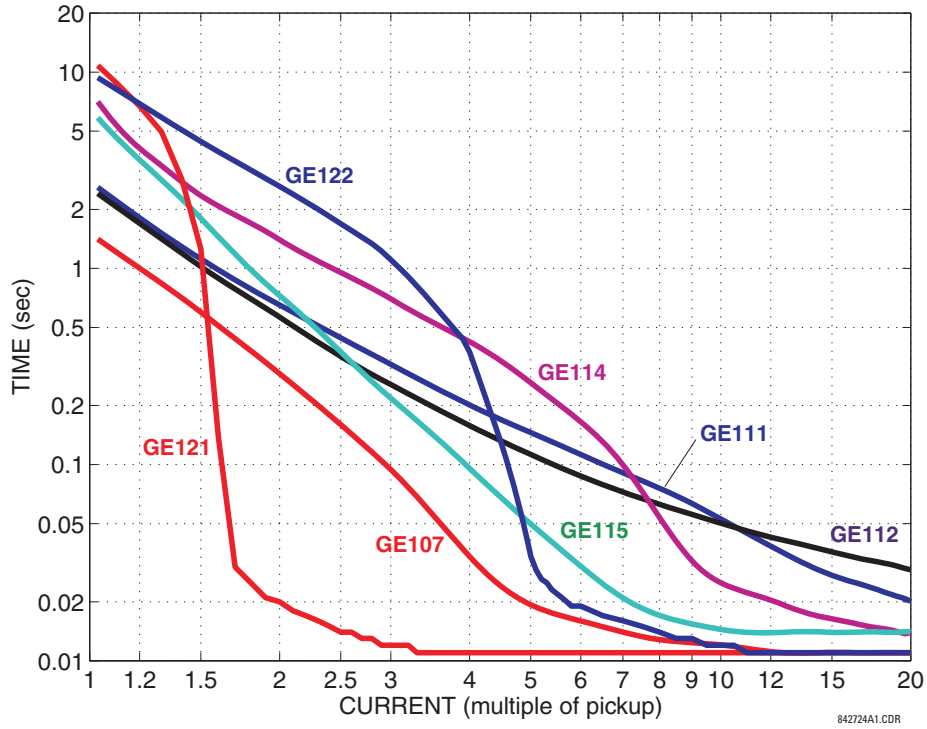

Figure 5-27: RECLOSER CURVES GE107, GE111, GE112, GE114, GE115, GE121, AND GE122

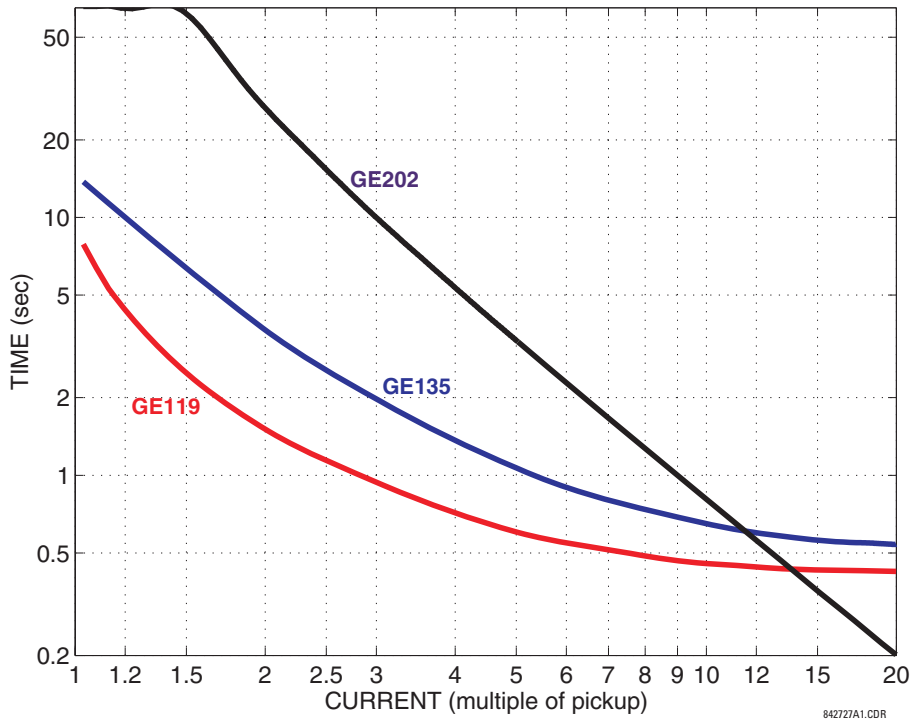

Figure 5-28: RECLOSER CURVES GE119, GE135, AND GE202

5.4.1 INTRODUCTION TO FLEXLOGIC™

To provide maximum flexibility to the user, the arrangement of internal digital logic combines fixed and user-programmed parameters. Logic upon which individual features are designed is fixed, and all other logic, from digital input signals through elements or combinations of elements to digital outputs, is variable. The user has complete control of all variable logic through FlexLogic™. In general, the system receives analog and digital inputs which it uses to produce analog and digital outputs. The major sub-systems of a generic UR-series relay involved in this process are shown below.

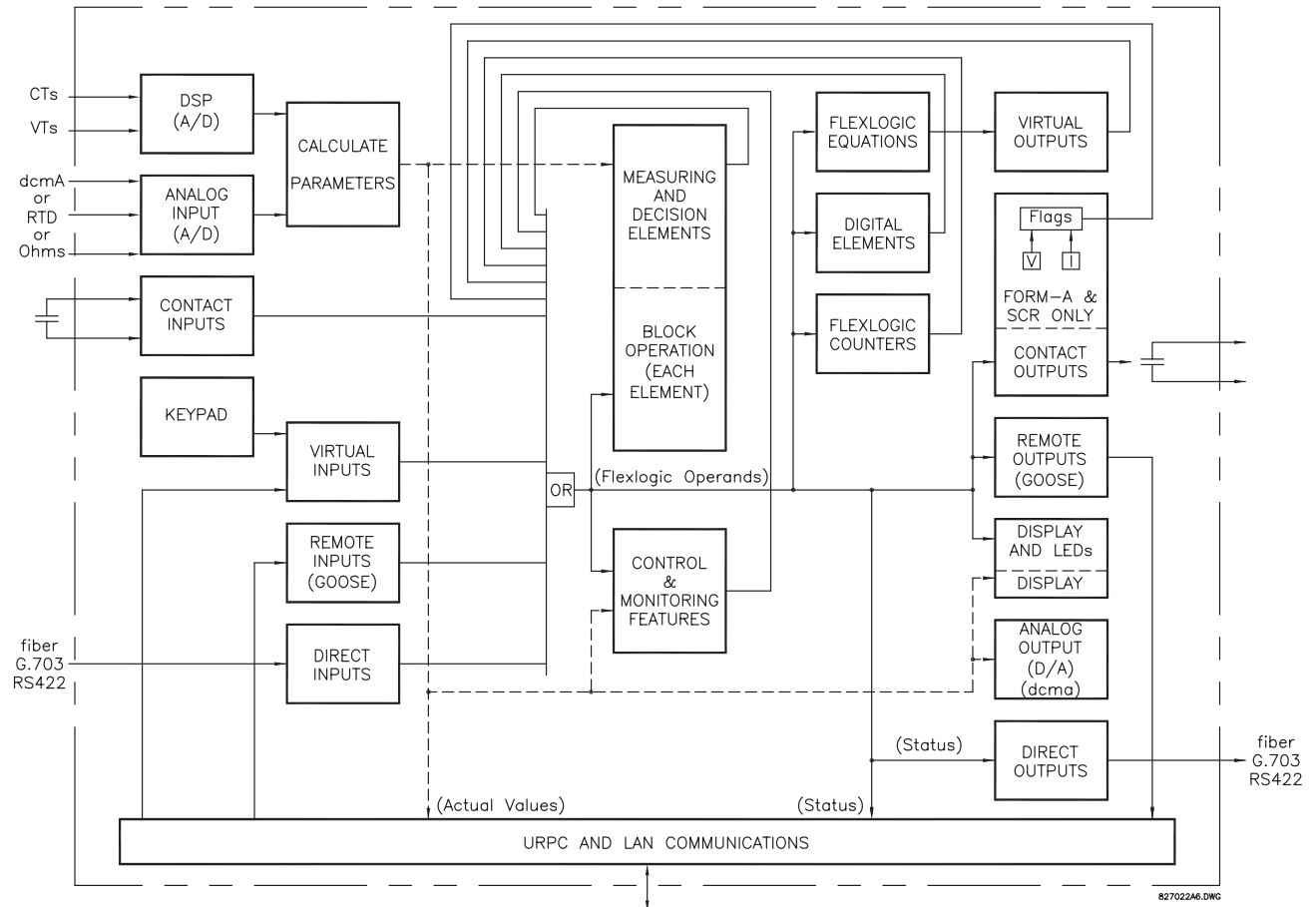

Figure 5-29: UR ARCHITECTURE OVERVIEW

The states of all digital signals used in the T60 are represented by flags (or FlexLogic™ operands, which are described later in this section). A digital “1” is represented by a 'set' flag. Any external contact change-of-state can be used to block an element from operating, as an input to a control feature in a FlexLogic™ equation, or to operate a contact output. The state of the contact input can be displayed locally or viewed remotely via the communications facilities provided. If a simple scheme where a contact input is used to block an element is desired, this selection is made when programming the element. This capability also applies to the other features that set flags: elements, virtual inputs, remote inputs, schemes, and human operators.

If more complex logic than presented above is required, it is implemented via FlexLogic™. For example, if it is desired to have the closed state of contact input H7a and the operated state of the phase undervoltage element block the operation of the phase time overcurrent element, the two control input states are programmed in a FlexLogic™ equation. This equation ANDs the two control inputs to produce a 'virtual output' which is then selected when programming the phase time overcurrent to be used as a blocking input. Virtual outputs can only be created by FlexLogic™ equations.

Traditionally, protective relay logic has been relatively limited. Any unusual applications involving interlocks, blocking, or supervisory functions had to be hard-wired using contact inputs and outputs. FlexLogic™ minimizes the requirement for auxiliary components and wiring while making more complex schemes possible.

The logic that determines the interaction of inputs, elements, schemes and outputs is field programmable through the use of logic equations that are sequentially processed. The use of virtual inputs and outputs in addition to hardware is available internally and on the communication ports for other relays to use (distributed FlexLogic™).

FlexLogic™ allows users to customize the relay through a series of equations that consist of operators and operands. The operands are the states of inputs, elements, schemes and outputs. The operators are logic gates, timers and latches (with set and reset inputs). A system of sequential operations allows any combination of specified operands to be assigned as inputs to specified operators to create an output. The final output of an equation is a numbered register called a virtual output. Virtual outputs can be used as an input operand in any equation, including the equation that generates the output, as a seal-in or other type of feedback.

A FlexLogic™ equation consists of parameters that are either operands or operators. Operands have a logic state of 1 or 0. Operators provide a defined function, such as an AND gate or a Timer. Each equation defines the combinations of parameters to be used to set a Virtual Output flag. Evaluation of an equation results in either a 1 (=ON, i.e. flag set) or 0 (=OFF, i.e. flag not set). Each equation is evaluated at least 4 times every power system cycle.

Some types of operands are present in the relay in multiple instances; e.g. contact and remote inputs. These types of operands are grouped together (for presentation purposes only) on the faceplate display. The characteristics of the different types of operands are listed in the table below.

Table 5–7: T60 FLEXLOGIC™ OPERAND TYPES

OPERAND TYPE	STATE	EXAMPLE FORMAT	CHARACTERISTICS [INPUT IS '1' (= ON) IF...]
Contact Input	On	Cont Ip On	Voltage is presently applied to the input (external contact closed).
	Off	Cont Ip Off	Voltage is presently not applied to the input (external contact open).
Contact Output (type Form-A contact only)	Voltage On	Cont Op 1 VOn	Voltage exists across the contact.
	Voltage Off	Cont Op 1 VOff	Voltage does not exist across the contact.
	Current On	Cont Op 1 IOOn	Current is flowing through the contact.
	Current Off	Cont Op 1 IOOff	Current is not flowing through the contact.
Direct Input	On	DIRECT INPUT 1 On	The direct input is presently in the ON state.
Element (Analog)	Pickup	PHASE TOC1 PKP	The tested parameter is presently above the pickup setting of an element which responds to rising values or below the pickup setting of an element which responds to falling values.
	Dropout	PHASE TOC1 DPO	This operand is the logical inverse of the above PKP operand.
	Operate	PHASE TOC1 OP	The tested parameter has been above/below the pickup setting of the element for the programmed delay time, or has been at logic 1 and is now at logic 0 but the reset timer has not finished timing.
	Block	PH DIR1 BLK	The output of the comparator is set to the block function.
Element (Digital)	Pickup	Dig Element 1 PKP	The input operand is at logic 1.
	Dropout	Dig Element 1 DPO	This operand is the logical inverse of the above PKP operand.
	Operate	Dig Element 1 OP	The input operand has been at logic 1 for the programmed pickup delay time, or has been at logic 1 for this period and is now at logic 0 but the reset timer has not finished timing.
Element (Digital Counter)	Higher than	Counter 1 HI	The number of pulses counted is above the set number.
	Equal to	Counter 1 EQL	The number of pulses counted is equal to the set number.
	Lower than	Counter 1 LO	The number of pulses counted is below the set number.
Fixed	On	On	Logic 1
	Off	Off	Logic 0
Remote Input	On	REMOTE INPUT 1 On	The remote input is presently in the ON state.
Virtual Input	On	Virt Ip 1 On	The virtual input is presently in the ON state.
Virtual Output	On	Virt Op 1 On	The virtual output is presently in the set state (i.e. evaluation of the equation which produces this virtual output results in a "1").

The operands available for this relay are listed alphabetically by types in the following table.

Table 5–8: T60 FLEXLOGIC™ OPERANDS (Sheet 1 of 5)

OPERAND TYPE	OPERAND SYNTAX	OPERAND DESCRIPTION
CONTROL PUSHBUTTONS	CONTROL PUSHBTN n ON	Control Pushbutton n ($n = 1$ to 7) is being pressed.
DIRECT DEVICES	DIRECT DEVICE 1On ↓ DIRECT DEVICE 16On DIRECT DEVICE 1Off ↓ DIRECT DEVICE 16Off	Flag is set, logic=1 ↓ Flag is set, logic=1 Flag is set, logic=1 ↓ Flag is set, logic=1
DIRECT INPUT/ OUTPUT CHANNEL MONITORING	DIR IO CH1(2) CRC ALARM DIR IO CRC ALARM DIR IO CH1(2) UNRET ALM DIR IO UNRET ALM	The rate of Direct Input messages received on Channel 1(2) and failing the CRC exceeded the user-specified level. The rate of Direct Input messages failing the CRC exceeded the user-specified level on Channel 1 or 2. The rate of returned direct input/output messages on Channel 1(2) exceeded the user-specified level (ring configurations only). The rate of returned direct input/output messages exceeded the user-specified level on Channel 1 or 2 (ring configurations only).
ELEMENT: Auxiliary Overvoltage	AUX OV1 PKP AUX OV1 DPO AUX OV1 OP	Auxiliary Overvoltage element has picked up Auxiliary Overvoltage element has dropped out Auxiliary Overvoltage element has operated
ELEMENT: Auxiliary Undervoltage	AUX UV1 PKP AUX UV1 DPO AUX UV1 OP	Auxiliary Undervoltage element has picked up Auxiliary Undervoltage element has dropped out Auxiliary Undervoltage element has operated
ELEMENT: Breaker Arcing	BKR ARC 1 OP BKR ARC 2 OP	Breaker Arcing Current 1 has operated Breaker Arcing Current 2 has operated
ELEMENT: Digital Counters	Counter 1 HI Counter 1 EQL Counter 1 LO ↓ Counter 8 HI Counter 8 EQL Counter 8 LO	Digital Counter 1 output is 'more than' comparison value Digital Counter 1 output is 'equal to' comparison value Digital Counter 1 output is 'less than' comparison value ↓ Digital Counter 8 output is 'more than' comparison value Digital Counter 8 output is 'equal to' comparison value Digital Counter 8 output is 'less than' comparison value
ELEMENT: Digital Elements	Dig Element 1 PKP Dig Element 1 OP Dig Element 1 DPO ↓ Dig Element 48 PKP Dig Element 48 OP Dig Element 48 DPO	Digital Element 1 is picked up Digital Element 1 is operated Digital Element 1 is dropped out ↓ Digital Element 48 is picked up Digital Element 48 is operated Digital Element 48 is dropped out
ELEMENT: FlexElements™	FxE 1 PKP FxE 1 OP FxE 1 DPO ↓ FxE 16 PKP FxE 16 OP FxE 16 DPO	FlexElement™ 1 has picked up FlexElement™ 1 has operated FlexElement™ 1 has dropped out ↓ FlexElement™ 16 has picked up FlexElement™ 16 has operated FlexElement™ 16 has dropped out
ELEMENT: Ground Instantaneous Overcurrent	GROUND IOC1 PKP GROUND IOC1 OP GROUND IOC1 DPO GROUND IOC2 to IOC8	Ground Instantaneous Overcurrent 1 has picked up Ground Instantaneous Overcurrent 1 has operated Ground Instantaneous Overcurrent 1 has dropped out Same set of operands as shown for GROUND IOC 1
ELEMENT: Ground Time Overcurrent	GROUND TOC1 PKP GROUND TOC1 OP GROUND TOC1 DPO GROUND TOC2 to TOC6	Ground Time Overcurrent 1 has picked up Ground Time Overcurrent 1 has operated Ground Time Overcurrent 1 has dropped out Same set of operands as shown for GROUND TOC1
ELEMENT Non-Volatile Latches	LATCH 1 ON LATCH 1 OFF ↓ LATCH 16 ON LATCH 16 OFF	Non-Volatile Latch 1 is ON (Logic = 1) Non-Voltage Latch 1 is OFF (Logic = 0) ↓ Non-Volatile Latch 16 is ON (Logic = 1) Non-Voltage Latch 16 is OFF (Logic = 0)
ELEMENT: Neutral Instantaneous Overcurrent	NEUTRAL IOC1 PKP NEUTRAL IOC1 OP NEUTRAL IOC1 DPO NEUTRAL IOC2 to IOC8	Neutral Instantaneous Overcurrent 1 has picked up Neutral Instantaneous Overcurrent 1 has operated Neutral Instantaneous Overcurrent 1 has dropped out Same set of operands as shown for NEUTRAL IOC1
ELEMENT: Neutral Overvoltage	NEUTRAL OV1 PKP NEUTRAL OV1 DPO NEUTRAL OV1 OP	Neutral Overvoltage element has picked up Neutral Overvoltage element has dropped out Neutral Overvoltage element has operated

Table 5–8: T60 FLEXLOGIC™ OPERANDS (Sheet 2 of 5)

OPERAND TYPE	OPERAND SYNTAX	OPERAND DESCRIPTION
ELEMENT: Neutral Time Overcurrent	NEUTRAL TOC1 PKP NEUTRAL TOC1 OP NEUTRAL TOC1 DPO	Neutral Time Overcurrent 1 has picked up Neutral Time Overcurrent 1 has operated Neutral Time Overcurrent 1 has dropped out
	NEUTRAL TOC2 to TOC6	Same set of operands as shown for NEUTRAL TOC1
ELEMENT: Neutral Directional Overcurrent	NTRL DIR OC1 FWD NTRL DIR OC1 REV	Neutral Directional OC1 Forward has operated Neutral Directional OC1 Reverse has operated
ELEMENT: Overfrequency	OVERFREQ 1 PKP OVERFREQ 1 OP OVERFREQ 1 DPO	Overfrequency 1 has picked up Overfrequency 1 has operated Overfrequency 1 has dropped out
	OVERFREQ 2 to 4	Same set of operands as shown for OVERFREQ 1
ELEMENT: Phase Directional Overcurrent	PH DIR1 BLK A PH DIR1 BLK B PH DIR1 BLK C PH DIR1 BLK	Phase A Directional 1 Block Phase B Directional 1 Block Phase C Directional 1 Block Phase Directional 1 Block
ELEMENT: Phase Instantaneous Overcurrent	PHASE IOC1 PKP PHASE IOC1 OP PHASE IOC1 DPO PHASE IOC1 PKP A PHASE IOC1 PKP B PHASE IOC1 PKP C PHASE IOC1 OP A PHASE IOC1 OP B PHASE IOC1 OP C PHASE IOC1 DPO A PHASE IOC1 DPO B PHASE IOC1 DPO C	At least one phase of PHASE IOC1 has picked up At least one phase of PHASE IOC1 has operated At least one phase of PHASE IOC1 has dropped out Phase A of PHASE IOC1 has picked up Phase B of PHASE IOC1 has picked up Phase C of PHASE IOC1 has picked up Phase A of PHASE IOC1 has operated Phase B of PHASE IOC1 has operated Phase C of PHASE IOC1 has operated Phase A of PHASE IOC1 has dropped out Phase B of PHASE IOC1 has dropped out Phase C of PHASE IOC1 has dropped out
	PHASE IOC2 to IOC8	Same set of operands as shown for PHASE IOC1
ELEMENT: Phase Overvoltage	PHASE OV1 PKP PHASE OV1 OP PHASE OV1 DPO PHASE OV1 PKP A PHASE OV1 PKP B PHASE OV1 PKP C PHASE OV1 OP A PHASE OV1 OP B PHASE OV1 OP C PHASE OV1 DPO A PHASE OV1 DPO B PHASE OV1 DPO C	At least one phase of Overvoltage 1 has picked up At least one phase of Overvoltage 1 has operated At least one phase of Overvoltage 1 has dropped out Phase A of Overvoltage 1 has picked up Phase B of Overvoltage 1 has picked up Phase C of Overvoltage 1 has picked up Phase A of Overvoltage 1 has operated Phase B of Overvoltage 1 has operated Phase C of Overvoltage 1 has operated Phase A of Overvoltage 1 has dropped out Phase B of Overvoltage 1 has dropped out Phase C of Overvoltage 1 has dropped out
ELEMENT: Phase Time Overcurrent	PHASE TOC1 PKP PHASE TOC1 OP PHASE TOC1 DPO PHASE TOC1 PKP A PHASE TOC1 PKP B PHASE TOC1 PKP C PHASE TOC1 OP A PHASE TOC1 OP B PHASE TOC1 OP C PHASE TOC1 DPO A PHASE TOC1 DPO B PHASE TOC1 DPO C	At least one phase of PHASE TOC1 has picked up At least one phase of PHASE TOC1 has operated At least one phase of PHASE TOC1 has dropped out Phase A of PHASE TOC1 has picked up Phase B of PHASE TOC1 has picked up Phase C of PHASE TOC1 has picked up Phase A of PHASE TOC1 has operated Phase B of PHASE TOC1 has operated Phase C of PHASE TOC1 has operated Phase A of PHASE TOC1 has dropped out Phase B of PHASE TOC1 has dropped out Phase C of PHASE TOC1 has dropped out
	PHASE TOC2 to TOC6	Same set of operands as shown for PHASE TOC1
ELEMENT: Phase Undervoltage	PHASE UV1 PKP PHASE UV1 OP PHASE UV1 DPO PHASE UV1 PKP A PHASE UV1 PKP B PHASE UV1 PKP C PHASE UV1 OP A PHASE UV1 OP B PHASE UV1 OP C PHASE UV1 DPO A PHASE UV1 DPO B PHASE UV1 DPO C	At least one phase of UV1 has picked up At least one phase of UV1 has operated At least one phase of UV1 has dropped out Phase A of UV1 has picked up Phase B of UV1 has picked up Phase C of UV1 has picked up Phase A of UV1 has operated Phase B of UV1 has operated Phase C of UV1 has operated Phase A of UV1 has dropped out Phase B of UV1 has dropped out Phase C of UV1 has dropped out
	PHASE UV2	Same set of operands as shown for PHASE UV1

Table 5–8: T60 FLEXLOGIC™ OPERANDS (Sheet 3 of 5)

OPERAND TYPE	OPERAND SYNTAX	OPERAND DESCRIPTION
ELEMENT: Restricted Ground Fault	RESTD GND FT1 PKP RESTD GND FT1 OP RESTD GND FT1 DPO	Restricted Ground Fault 1 has picked up Restricted Ground Fault 1 has operated Restricted Ground Fault 1 has dropped out
	RESTD GND FT2 to FT4	Same set of operands as shown for RESTD GND FT1
ELEMENT: Selector Switch	SELECTOR 1 POS Y SELECTOR 1 BIT 0 SELECTOR 1 BIT 1 SELECTOR 1 BIT 2 SELECTOR 1 STP ALARM	Selector Switch 1 is in Position Y (mutually exclusive operands). First bit of the 3-bit word encoding position of Selector 1. Second bit of the 3-bit word encoding position of Selector 1. Third bit of the 3-bit word encoding position of Selector 1. Position of Selector 1 has been pre-selected with the stepping up control input but not acknowledged.
	SELECTOR 1 BIT ALARM SELECTOR 1 ALARM SELECTOR 1 PWR ALARM	Position of Selector 1 has been pre-selected with the 3-bit control input but not acknowledged. Position of Selector 1 has been pre-selected but not acknowledged. Position of Selector Switch 1 is undetermined or restored from memory when the relay powers up and synchronizes to the 3-bit input.
	SELECTOR 2	Same set of operands as shown above for SELECTOR 1
ELEMENT: Setting Group	SETTING GROUP ACT 1 ↓ SETTING GROUP ACT 6	Setting Group 1 is active ↓ Setting Group 6 is active
	SRCx 50DD OP	Source x Disturbance Detector has operated
ELEMENT: Teleprotection Inputs/Outputs	TELEPRO CH1 FAIL TELEPRO CH2 FAIL TELEPRO CH1 ID FAIL TELEPRO CH2 ID FAIL TELEPRO CH1 CRC FAIL TELEPRO CH2 CRC FAIL TELEPRO CH1 PKT LOST TELEPRO CH2 PKT LOST	Channel 1 failed Channel 2 failed The ID check for a peer relay on channel 1 has failed The ID check for a peer relay on channel 2 has failed CRC detected packet corruption on channel 1 CRC detected packet corruption on channel 2 CRC detected lost packet on channel 1 CRC detected lost packet on channel 2
	TELEPRO INPUT 1-1 On ↓ TELEPRO INPUT 1-16 On ↓ TELEPRO INPUT 2-1 On ↓ TELEPRO INPUT 2-16 On	Flag is set, Logic =1 ↓ Flag is set, Logic =1 ↓ Flag is set, Logic =1 ↓ Flag is set, Logic =1
ELEMENT: Underfrequency	UNDERFREQ 1 PKP UNDERFREQ 1 OP UNDERFREQ 1 DPO	Underfrequency 1 has picked up Underfrequency 1 has operated Underfrequency 1 has dropped out
	UNDERFREQ 2 to 6	Same set of operands as shown for UNDERFREQ 1 above
ELEMENT: Volts per Hertz	VOLT PER HERTZ 1 PKP VOLT PER HERTZ 1 OP VOLT PER HERTZ 1 DPO	V/Hz element 1 has picked up V/Hz element 1 has operated V/Hz element 1 has dropped out
	VOLT PER HERTZ 2	Same set of operands as VOLT PER HERTZ 1 above
ELEMENT: Transformer Aging Factor	XFMR AGING FCTR PKP XFMR AGING FCTR OP XFMR AGING FCTR DPO	The Transformer Aging Factor element has picked up The Transformer Aging Factor element has operated The Transformer Aging Factor element has dropped out
ELEMENT: Transformer Instantaneous Differential	XFMR INST DIFF OP XFMR INST DIFF OP A XFMR INST DIFF OP B XFMR INST DIFF OP C	At least one phase of Transformer Instantaneous Differential has operated Phase A of Transformer Instantaneous Differential has operated Phase B of Transformer Instantaneous Differential has operated Phase C of Transformer Instantaneous Differential has operated
ELEMENT: Hottest-Spot Temperature	XFMR HST-SPOT °C PKP XFMR HST-SPOT °C OP XFMR HST-SPOT °C DPO	The Hottest-Spot Temperature element has picked up The Hottest-Spot Temperature element has operated The Hottest-Spot Temperature element has dropped out
ELEMENT: Transformer Loss of Life	XFMR LIFE LOST PKP XFMR LIFE LOST OP	The Transformer Loss of Life element has picked up The Transformer Loss of Life element has operated

Table 5–8: T60 FLEXLOGIC™ OPERANDS (Sheet 4 of 5)

OPERAND TYPE	OPERAND SYNTAX	OPERAND DESCRIPTION
ELEMENT: Transformer Percent Differential	XFMR PCNT DIFF PKP A XFMR PCNT DIFF PKP B XFMR PCNT DIFF PKP C XFMR PCNT DIFF 2ND A XFMR PCNT DIFF 2ND B XFMR PCNT DIFF 2ND C XFMR PCNT DIFF 5TH A XFMR PCNT DIFF 5TH B XFMR PCNT DIFF 5TH C XFMR PCNT DIFF OP XFMR PCNT DIFF OP A XFMR PCNT DIFF OP B XFMR PCNT DIFF OP C	Transformer Percent Differential protection has picked up in Phase A Transformer Percent Differential protection has picked up in Phase B Transformer Percent Differential protection has picked up in Phase C The 2nd harmonic of Transformer Percent Differential has blocked Phase A The 2nd harmonic of Transformer Percent Differential has blocked Phase B The 2nd harmonic of Transformer Percent Differential has blocked Phase C The 5th harmonic of Transformer Percent Differential has blocked Phase A The 5th harmonic of Transformer Percent Differential has blocked Phase B The 5th harmonic of Transformer Percent Differential has blocked Phase C At least one phase of Transformer Percent Differential has operated Phase A of Transformer Percent Differential has operated Phase B of Transformer Percent Differential has operated Phase C of Transformer Percent Differential has operated
FIXED OPERANDS	Off	Logic = 0. Does nothing and may be used as a delimiter in an equation list; used as 'Disable' by other features.
	On	Logic = 1. Can be used as a test setting.
INPUTS/OUTPUTS: Contact Inputs	Cont Ip 1 On ↓ Cont Ip 2 On	(will not appear unless ordered) (will not appear unless ordered) ↓
	Cont Ip 1 Off ↓ Cont Ip 2 Off	(will not appear unless ordered) (will not appear unless ordered) ↓
INPUTS/OUTPUTS: Contact Outputs, Current (from detector on Form-A output only)	Cont Op 1 IOn ↓ Cont Op 2 IOn	(will not appear unless ordered) (will not appear unless ordered) ↓
	Cont Op 1 IOff ↓ Cont Op 2 IOff	(will not appear unless ordered) (will not appear unless ordered) ↓
INPUTS/OUTPUTS: Contact Outputs, Voltage (from detector on Form-A output only)	Cont Op 1 VOn ↓ Cont Op 2 VOn	(will not appear unless ordered) (will not appear unless ordered) ↓
	Cont Op 1 VOff ↓ Cont Op 2 VOff	(will not appear unless ordered) (will not appear unless ordered) ↓
INPUTS/OUTPUTS Direct Inputs	DIRECT INPUT 1 On ↓ DIRECT INPUT 32 On	Flag is set, logic=1 ↓ Flag is set, logic=1
	REMOTE INPUT 1 On ↓ REMOTE INPUT 32 On	Flag is set, logic=1 ↓ Flag is set, logic=1
INPUTS/OUTPUTS: Virtual Inputs	Virt Ip 1 On ↓ Virt Ip 64 On	Flag is set, logic=1 ↓ Flag is set, logic=1
	Virt Op 1 On ↓ Virt Op 96 On	Flag is set, logic=1 ↓ Flag is set, logic=1
LED TEST	LED TEST IN PROGRESS	An LED test has been initiated and has not finished.
REMOTE DEVICES	REMOTE DEVICE 1 On ↓ REMOTE DEVICE 16 On	Flag is set, logic=1 ↓ Flag is set, logic=1
	REMOTE DEVICE 1 Off ↓ REMOTE DEVICE 16 Off	Flag is set, logic=1 ↓ Flag is set, logic=1
	RESET OP RESET OP (COMMS) RESET OP (OPERAND)	Reset command is operated (set by all 3 operands below) Communications source of the reset command Operand (assigned in the INPUTS/OUTPUTS ⇄ RESETTING menu) source of the reset command
	RESET OP (PUSHBUTTON)	Reset key (pushbutton) source of the reset command

Table 5–8: T60 FLEXLOGIC™ OPERANDS (Sheet 5 of 5)

OPERAND TYPE	OPERAND SYNTAX	OPERAND DESCRIPTION
SELF-DIAGNOSTICS	ANY MAJOR ERROR ANY MINOR ERROR ANY SELF-TEST BATTERY FAIL DIRECT DEVICE OFF DIRECT RING BREAK DSP ERROR EEPROM DATA ERROR EQUIPMENT MISMATCH FLEXLOGIC ERR TOKEN IRIG-B FAILURE LATCHING OUT ERROR LOW ON MEMORY NO DSP INTERRUPTS PRI ETHERNET FAIL PROGRAM MEMORY PROTOTYPE FIRMWARE REMOTE DEVICE OFF SEC ETHERNET FAIL SNTP FAILURE SYSTEM EXCEPTION UNIT NOT CALIBRATED UNIT NOT PROGRAMMED WATCHDOG ERROR	Any of the major self-test errors generated (major error) Any of the minor self-test errors generated (minor error) Any self-test errors generated (generic, any error) See description in Chapter 7: Commands and Targets.
UNAUTHORIZED ACCESS ALARM	UNAUTHORIZED ACCESS	Asserted when a password entry fails while accessing a password-protected level of the relay.
USER-PROGRAMMABLE PUSHBUTTONS	PUSHBUTTON x ON PUSHBUTTON x OFF	Pushbutton Number x is in the 'On' position Pushbutton Number x is in the 'Off' position

Some operands can be re-named by the user. These are the names of the breakers in the breaker control feature, the ID (identification) of contact inputs, the ID of virtual inputs, and the ID of virtual outputs. If the user changes the default name/ID of any of these operands, the assigned name will appear in the relay list of operands. The default names are shown in the FlexLogic™ operands table above.

The characteristics of the logic gates are tabulated below, and the operators available in FlexLogic™ are listed in the FlexLogic™ operators table.

Table 5–9: FLEXLOGIC™ GATE CHARACTERISTICS

GATES	NUMBER OF INPUTS	OUTPUT IS '1' (= ON) IF...
NOT	1	input is '0'
OR	2 to 16	any input is '1'
AND	2 to 16	all inputs are '1'
NOR	2 to 16	all inputs are '0'
NAND	2 to 16	any input is '0'
XOR	2	only one input is '1'

Table 5–10: FLEXLOGIC™ OPERATORS

TYPE	SYNTAX	DESCRIPTION	NOTES
Editor	INSERT	Insert a parameter in an equation list.	
	DELETE	Delete a parameter from an equation list.	
End	END	The first END encountered signifies the last entry in the list of processed FlexLogic™ parameters.	
One Shot	POSITIVE ONE SHOT	One shot that responds to a positive going edge.	A 'one shot' refers to a single input gate that generates a pulse in response to an edge on the input. The output from a 'one shot' is True (positive) for only one pass through the FlexLogic™ equation. There is a maximum of 64 'one shots'.
	NEGATIVE ONE SHOT	One shot that responds to a negative going edge.	
	DUAL ONE SHOT	One shot that responds to both the positive and negative going edges.	
Logic Gate	NOT	Logical Not	Operates on the previous parameter.
	OR(2)	2 input OR gate	Operates on the 2 previous parameters.
	OR(16)	16 input OR gate	Operates on the 16 previous parameters.
	AND(2)	2 input AND gate	Operates on the 2 previous parameters.
	AND(16)	16 input AND gate	Operates on the 16 previous parameters.
	NOR(2)	2 input NOR gate	Operates on the 2 previous parameters.
	NOR(16)	16 input NOR gate	Operates on the 16 previous parameters.
	NAND(2)	2 input NAND gate	Operates on the 2 previous parameters.
	NAND(16)	16 input NAND gate	Operates on the 16 previous parameters.
	XOR(2)	2 input Exclusive OR gate	Operates on the 2 previous parameters.
	LATCH (S,R)	Latch (Set, Reset) - reset-dominant	The parameter preceding LATCH(S,R) is the Reset input. The parameter preceding the Reset input is the Set input.
Timer	TIMER 1	Timer set with FlexLogic™ Timer 1 settings.	The timer is started by the preceding parameter. The output of the timer is TIMER #.
	TIMER 32	Timer set with FlexLogic™ Timer 32 settings.	
Assign Virtual Output	= Virt Op 1 ↓ = Virt Op 96	Assigns previous FlexLogic™ parameter to Virtual Output 1. ↓ Assigns previous FlexLogic™ parameter to Virtual Output 96.	The virtual output is set by the preceding parameter

5.4.2 FLEXLOGIC™ RULES

When forming a FlexLogic™ equation, the sequence in the linear array of parameters must follow these general rules:

1. Operands must precede the operator which uses the operands as inputs.
2. Operators have only one output. The output of an operator must be used to create a virtual output if it is to be used as an input to two or more operators.
3. Assigning the output of an operator to a Virtual Output terminates the equation.
4. A timer operator (e.g. "TIMER 1") or virtual output assignment (e.g. "= Virt Op 1") may only be used once. If this rule is broken, a syntax error will be declared.

5.4.3 FLEXLOGIC™ EVALUATION

Each equation is evaluated in the order in which the parameters have been entered.



FlexLogic™ provides latches which by definition have a memory action, remaining in the set state after the set input has been asserted. However, they are *volatile*; i.e. they reset on the re-application of control power.

When making changes to settings, all FlexLogic™ equations are re-compiled whenever any new setting value is entered, so all latches are automatically reset. If it is necessary to re-initialize FlexLogic™ during testing, for example, it is suggested to power the unit down and then back up.

5.4.4 FLEXLOGIC™ EXAMPLE

This section provides an example of implementing logic for a typical application. The sequence of the steps is quite important as it should minimize the work necessary to develop the relay settings. Note that the example presented in the figure below is intended to demonstrate the procedure, not to solve a specific application situation.

In the example below, it is assumed that logic has already been programmed to produce Virtual Outputs 1 and 2, and is only a part of the full set of equations used. When using FlexLogic™, it is important to make a note of each Virtual Output used – a Virtual Output designation (1 to 96) can only be properly assigned once.

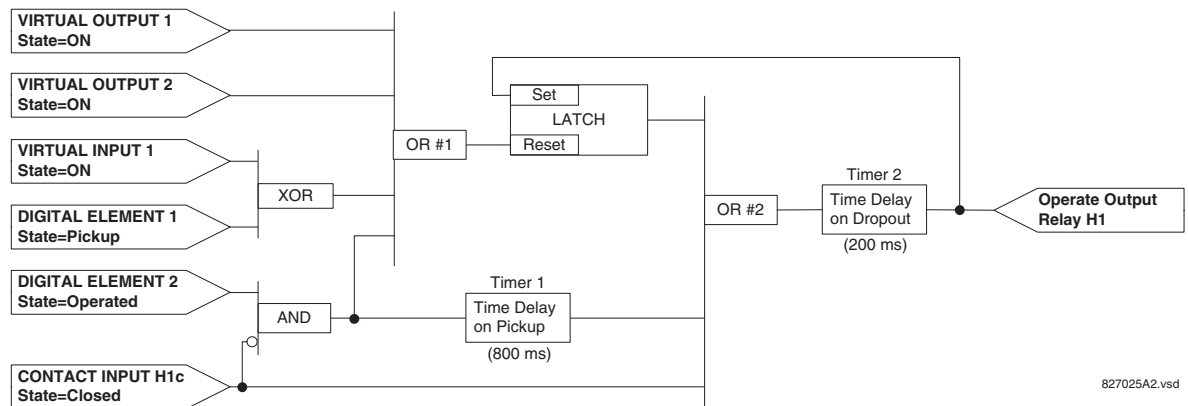

Figure 5–30: EXAMPLE LOGIC SCHEME

1. Inspect the example logic diagram to determine if the required logic can be implemented with the FlexLogic™ operators. If this is not possible, the logic must be altered until this condition is satisfied. Once this is done, count the inputs to each gate to verify that the number of inputs does not exceed the FlexLogic™ limits, which is unlikely but possible. If the number of inputs is too high, subdivide the inputs into multiple gates to produce an equivalent. For example, if 25 inputs to an AND gate are required, connect Inputs 1 through 16 to AND(16), 17 through 25 to AND(9), and the outputs from these two gates to AND(2).

Inspect each operator between the initial operands and final virtual outputs to determine if the output from the operator is used as an input to more than one following operator. If so, the operator output must be assigned as a Virtual Output.

For the example shown above, the output of the AND gate is used as an input to both OR#1 and Timer 1, and must therefore be made a Virtual Output and assigned the next available number (i.e. Virtual Output 3). The final output must also be assigned to a Virtual Output as Virtual Output 4, which will be programmed in the contact output section to operate relay H1 (i.e. Output Contact H1).

Therefore, the required logic can be implemented with two FlexLogic™ equations with outputs of Virtual Output 3 and Virtual Output 4 as shown below.

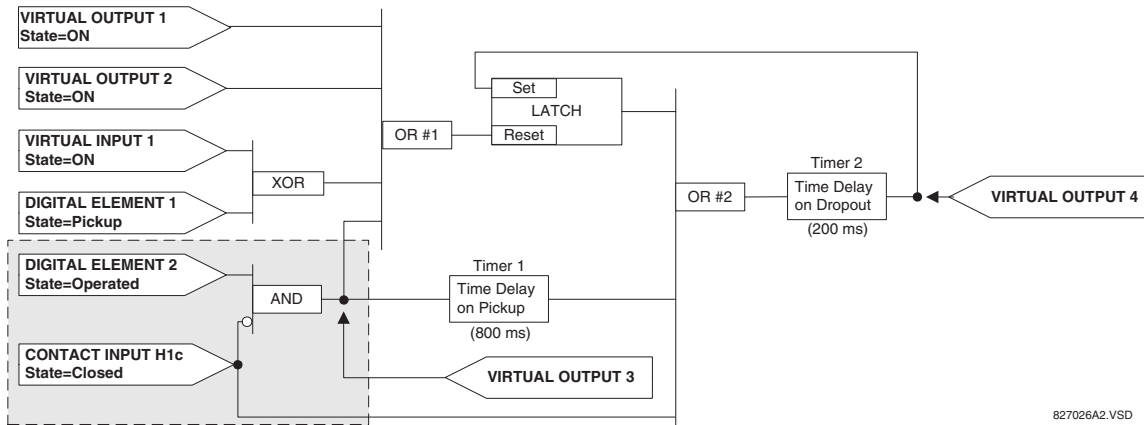

Figure 5-31: LOGIC EXAMPLE WITH VIRTUAL OUTPUTS

- Prepare a logic diagram for the equation to produce Virtual Output 3, as this output will be used as an operand in the Virtual Output 4 equation (create the equation for every output that will be used as an operand first, so that when these operands are required they will already have been evaluated and assigned to a specific Virtual Output). The logic for Virtual Output 3 is shown below with the final output assigned.

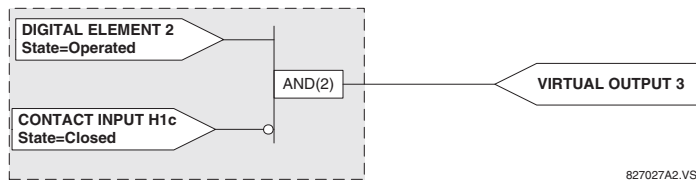

Figure 5-32: LOGIC FOR VIRTUAL OUTPUT 3

- Prepare a logic diagram for Virtual Output 4, replacing the logic ahead of Virtual Output 3 with a symbol identified as Virtual Output 3, as shown below.

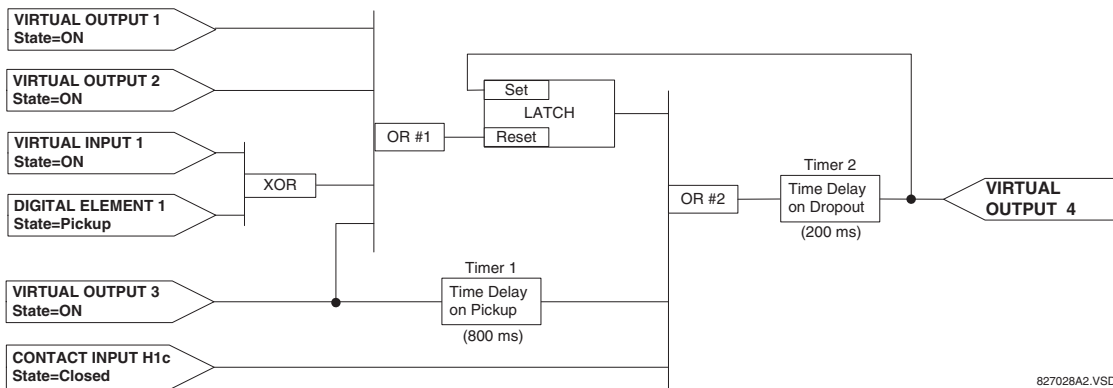

Figure 5-33: LOGIC FOR VIRTUAL OUTPUT 4

- Program the FlexLogic™ equation for Virtual Output 3 by translating the logic into available FlexLogic™ parameters. The equation is formed one parameter at a time until the required logic is complete. It is generally easier to start at the output end of the equation and work back towards the input, as shown in the following steps. It is also recommended to list operator inputs from bottom to top. For demonstration, the final output will be arbitrarily identified as parameter 99,

and each preceding parameter decremented by one in turn. Until accustomed to using FlexLogic™, it is suggested that a worksheet with a series of cells marked with the arbitrary parameter numbers be prepared, as shown below.

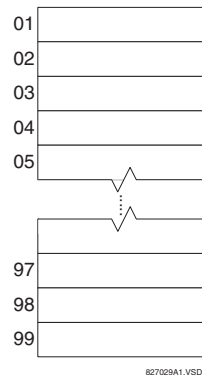

Figure 5-34: FLEXLOGIC™ WORKSHEET

5. Following the procedure outlined, start with parameter 99, as follows:
 - 99: The final output of the equation is Virtual Output 3, which is created by the operator "= Virt Op n". This parameter is therefore "= Virt Op 3."
 - 98: The gate preceding the output is an AND, which in this case requires two inputs. The operator for this gate is a 2-input AND so the parameter is "AND(2)". Note that FlexLogic™ rules require that the number of inputs to most types of operators must be specified to identify the operands for the gate. As the 2-input AND will operate on the two operands preceding it, these inputs must be specified, starting with the lower.
 - 97: This lower input to the AND gate must be passed through an inverter (the NOT operator) so the next parameter is "NOT". The NOT operator acts upon the operand immediately preceding it, so specify the inverter input next.
 - 96: The input to the NOT gate is to be contact input H1c. The ON state of a contact input can be programmed to be set when the contact is either open or closed. Assume for this example the state is to be ON for a closed contact. The operand is therefore "Cont Ip H1c On".
 - 95: The last step in the procedure is to specify the upper input to the AND gate, the operated state of digital element 2. This operand is "DIG ELEM 2 OP".

Writing the parameters in numerical order can now form the equation for VIRTUAL OUTPUT 3:

```
[95] DIG ELEM 2 OP
[96] Cont Ip H1c On
[97] NOT
[98] AND(2)
[99] = Virt Op 3
```

It is now possible to check that this selection of parameters will produce the required logic by converting the set of parameters into a logic diagram. The result of this process is shown below, which is compared to the Logic for Virtual Output 3 diagram as a check.

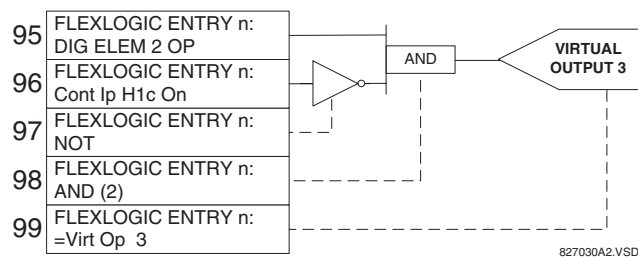

Figure 5-35: FLEXLOGIC™ EQUATION FOR VIRTUAL OUTPUT 3

6. Repeating the process described for VIRTUAL OUTPUT 3, select the FlexLogic™ parameters for Virtual Output 4.

- 99: The final output of the equation is VIRTUAL OUTPUT 4 which is parameter "= Virt Op 4".
- 98: The operator preceding the output is Timer 2, which is operand "TIMER 2". Note that the settings required for the timer are established in the timer programming section.
- 97: The operator preceding Timer 2 is OR #2, a 3-input OR, which is parameter "OR(3)".
- 96: The lowest input to OR #2 is operand "Cont Ip H1c On".
- 95: The center input to OR #2 is operand "TIMER 1".
- 94: The input to Timer 1 is operand "Virt Op 3 On".
- 93: The upper input to OR #2 is operand "LATCH (S,R)".
- 92: There are two inputs to a latch, and the input immediately preceding the latch reset is OR #1, a 4-input OR, which is parameter "OR(4)".
- 91: The lowest input to OR #1 is operand "Virt Op 3 On".
- 90: The input just above the lowest input to OR #1 is operand "XOR(2)".
- 89: The lower input to the XOR is operand "DIG ELEM 1 PKP".
- 88: The upper input to the XOR is operand "Virt Ip 1 On".
- 87: The input just below the upper input to OR #1 is operand "Virt Op 2 On".
- 86: The upper input to OR #1 is operand "Virt Op 1 On".
- 85: The last parameter is used to set the latch, and is operand "Virt Op 4 On".

The equation for VIRTUAL OUTPUT 4 is:

```
[85] Virt Op 4 On
[86] Virt Op 1 On
[87] Virt Op 2 On
[88] Virt Ip 1 On
[89] DIG ELEM 1 PKP
[90] XOR(2)
[91] Virt Op 3 On
[92] OR(4)
[93] LATCH (S,R)
[94] Virt Op 3 On
[95] TIMER 1
[96] Cont Ip H1c On
[97] OR(3)
[98] TIMER 2
[99] = Virt Op 4
```

It is now possible to check that the selection of parameters will produce the required logic by converting the set of parameters into a logic diagram. The result of this process is shown below, which is compared to the Logic for Virtual Output 4 diagram as a check.

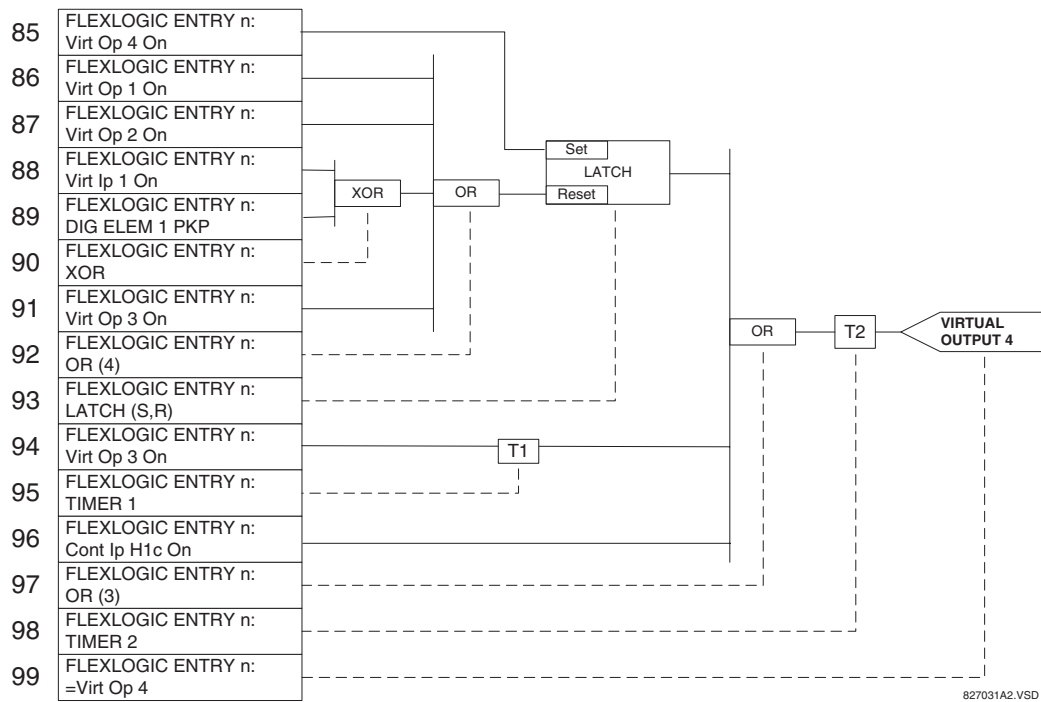

Figure 5-36: FLEXLOGIC™ EQUATION FOR VIRTUAL OUTPUT 4

7. Now write the complete FlexLogic™ expression required to implement the logic, making an effort to assemble the equation in an order where Virtual Outputs that will be used as inputs to operators are created before needed. In cases where a lot of processing is required to perform logic, this may be difficult to achieve, but in most cases will not cause problems as all logic is calculated at least 4 times per power frequency cycle. The possibility of a problem caused by sequential processing emphasizes the necessity to test the performance of FlexLogic™ before it is placed in service.

In the following equation, Virtual Output 3 is used as an input to both Latch 1 and Timer 1 as arranged in the order shown below:

```

DIG ELEM 2 OP
Cont Ip H1c On
NOT
AND(2)
= Virt Op 3
Virt Op 4 On
Virt Op 1 On
Virt Op 2 On
Virt Ip 1 On
DIG ELEM 1 PKP
XOR(2)
Virt Op 3 On
OR(4)
LATCH (S,R)
Virt Op 3 On
TIMER 1
Cont Ip H1c On
OR(3)
TIMER 2
= Virt Op 4
END

```

In the expression above, the Virtual Output 4 input to the 4-input OR is listed before it is created. This is typical of a form of feedback, in this case, used to create a seal-in effect with the latch, and is correct.

8. The logic should always be tested after it is loaded into the relay, in the same fashion as has been used in the past. Testing can be simplified by placing an "END" operator within the overall set of FlexLogic™ equations. The equations will then only be evaluated up to the first "END" operator.

The "On" and "Off" operands can be placed in an equation to establish a known set of conditions for test purposes, and the "INSERT" and "DELETE" commands can be used to modify equations.

5.4.5 FLEXLOGIC™ EQUATION EDITOR

PATH: SETTINGS ⇨ FLEXLOGIC ⇨ FLEXLOGIC EQUATION EDITOR

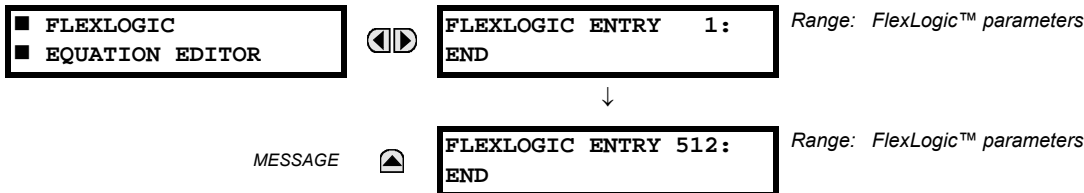

There are 512 FlexLogic™ entries available, numbered from 1 to 512, with default 'END' entry settings. If a "Disabled" Element is selected as a FlexLogic™ entry, the associated state flag will never be set to '1'. The '+/-' key may be used when editing FlexLogic™ equations from the keypad to quickly scan through the major parameter types.

5.4.6 FLEXLOGIC™ TIMERS

PATH: SETTINGS ⇨ FLEXLOGIC ⇨ FLEXLOGIC TIMERS ⇨ FLEXLOGIC TIMER 1(32)

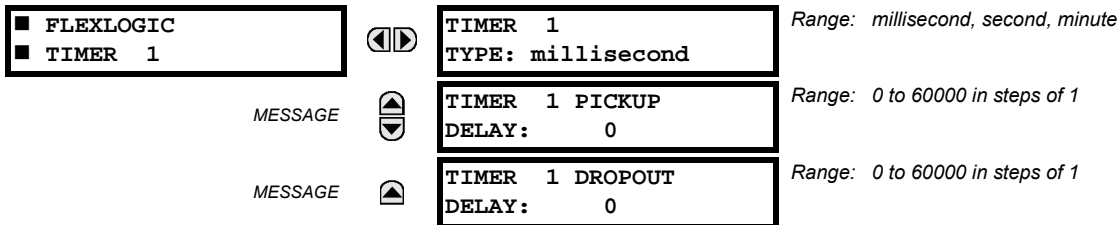

There are 32 identical FlexLogic™ timers available. These timers can be used as operators for FlexLogic™ equations.

- **TIMER 1 TYPE:** This setting is used to select the time measuring unit.
- **TIMER 1 PICKUP DELAY:** Sets the time delay to pickup. If a pickup delay is not required, set this function to "0".
- **TIMER 1 DROPOUT DELAY:** Sets the time delay to dropout. If a dropout delay is not required, set this function to "0".

5.4.7 FLEXELEMENTS™

PATH: SETTING ⇒ FLEXLOGIC ⇒ FLEXELEMENTS ⇒ FLEXELEMENT 1(16)

■ FLEXELEMENT 1	◀▶	FLEXELEMENT 1 FUNCTION: Disabled	Range: Disabled, Enabled
MESSAGE	▲▼	FLEXELEMENT 1 NAME: FxE1	Range: up to 6 alphanumeric characters
MESSAGE	▲▼	FLEXELEMENT 1 +IN: Off	Range: Off, any analog actual value parameter
MESSAGE	▲▼	FLEXELEMENT 1 -IN: Off	Range: Off, any analog actual value parameter
MESSAGE	▲▼	FLEXELEMENT 1 INPUT MODE: Signed	Range: Signed, Absolute
MESSAGE	▲▼	FLEXELEMENT 1 COMP MODE: Level	Range: Level, Delta
MESSAGE	▲▼	FLEXELEMENT 1 DIRECTION: Over	Range: Over, Under
MESSAGE	▲▼	FLEXELEMENT 1 PICKUP: 1.000 pu	Range: -90.000 to 90.000 pu in steps of 0.001
MESSAGE	▲▼	FLEXELEMENT 1 HYSTERESIS: 3.0%	Range: 0.1 to 50.0% in steps of 0.1
MESSAGE	▲▼	FLEXELEMENT 1 dt UNIT: milliseconds	Range: milliseconds, seconds, minutes
MESSAGE	▲▼	FLEXELEMENT 1 dt: 20	Range: 20 to 86400 in steps of 1
MESSAGE	▲▼	FLEXELEMENT 1 PKP DELAY: 0.000 s	Range: 0.000 to 65.535 s in steps of 0.001
MESSAGE	▲▼	FLEXELEMENT 1 RST DELAY: 0.000 s	Range: 0.000 to 65.535 s in steps of 0.001
MESSAGE	▲▼	FLEXELEMENT 1 BLK: Off	Range: FlexLogic™ operand
MESSAGE	▲▼	FLEXELEMENT 1 TARGET: Self-reset	Range: Self-reset, Latched, Disabled
MESSAGE	▲	FLEXELEMENT 1 EVENTS: Disabled	Range: Disabled, Enabled

A FlexElement™ is a universal comparator that can be used to monitor any analog actual value calculated by the relay or a net difference of any two analog actual values of the same type. The effective operating signal could be treated as a signed number or its absolute value could be used as per user's choice.

The element can be programmed to respond either to a signal level or to a rate-of-change (delta) over a pre-defined period of time. The output operand is asserted when the operating signal is higher than a threshold or lower than a threshold as per user's choice.

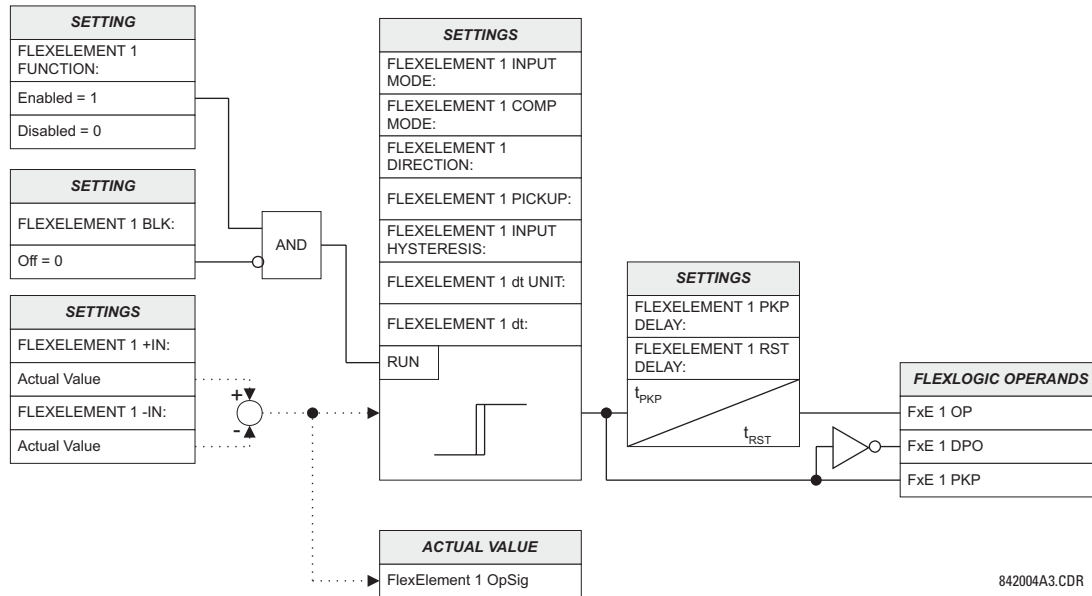

Figure 5-37: FLEXELEMENT™ SCHEME LOGIC

The **FLEXELEMENT 1 +IN** setting specifies the first (non-inverted) input to the FlexElement™. Zero is assumed as the input if this setting is set to “Off”. For proper operation of the element at least one input must be selected. Otherwise, the element will not assert its output operands.

This **FLEXELEMENT 1 –IN** setting specifies the second (inverted) input to the FlexElement™. Zero is assumed as the input if this setting is set to “Off”. For proper operation of the element at least one input must be selected. Otherwise, the element will not assert its output operands. This input should be used to invert the signal if needed for convenience, or to make the element respond to a differential signal such as for a top-bottom oil temperature differential alarm. The element will not operate if the two input signals are of different types, for example if one tries to use active power and phase angle to build the effective operating signal.

The element responds directly to the differential signal if the **FLEXELEMENT 1 INPUT MODE** setting is set to “Signed”. The element responds to the absolute value of the differential signal if this setting is set to “Absolute”. Sample applications for the “Absolute” setting include monitoring the angular difference between two phasors with a symmetrical limit angle in both directions; monitoring power regardless of its direction, or monitoring a trend regardless of whether the signal increases or decreases.

The element responds directly to its operating signal – as defined by the **FLEXELEMENT 1 +IN**, **FLEXELEMENT 1 –IN** and **FLEXELEMENT 1 INPUT MODE** settings – if the **FLEXELEMENT 1 COMP MODE** setting is set to “Level”. The element responds to the rate of change of its operating signal if the **FLEXELEMENT 1 COMP MODE** setting is set to “Delta”. In this case the **FLEXELEMENT 1 dt UNIT** and **FLEXELEMENT 1 dt** settings specify how the rate of change is derived.

The **FLEXELEMENT 1 DIRECTION** setting enables the relay to respond to either high or low values of the operating signal. The following figure explains the application of the **FLEXELEMENT 1 DIRECTION**, **FLEXELEMENT 1 PICKUP** and **FLEXELEMENT 1 HYSTERESIS** settings.

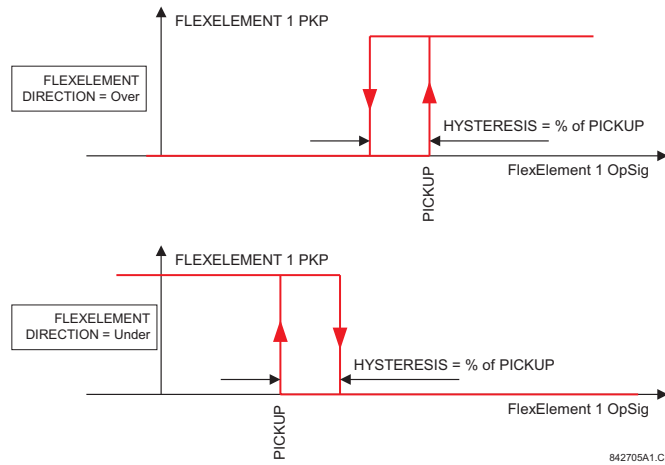

Figure 5–38: FLEXELEMENT™ DIRECTION, PICKUP, AND HYSTERESIS

In conjunction with the **FLEXELEMENT 1 INPUT MODE** setting the element could be programmed to provide two extra characteristics as shown in the figure below.

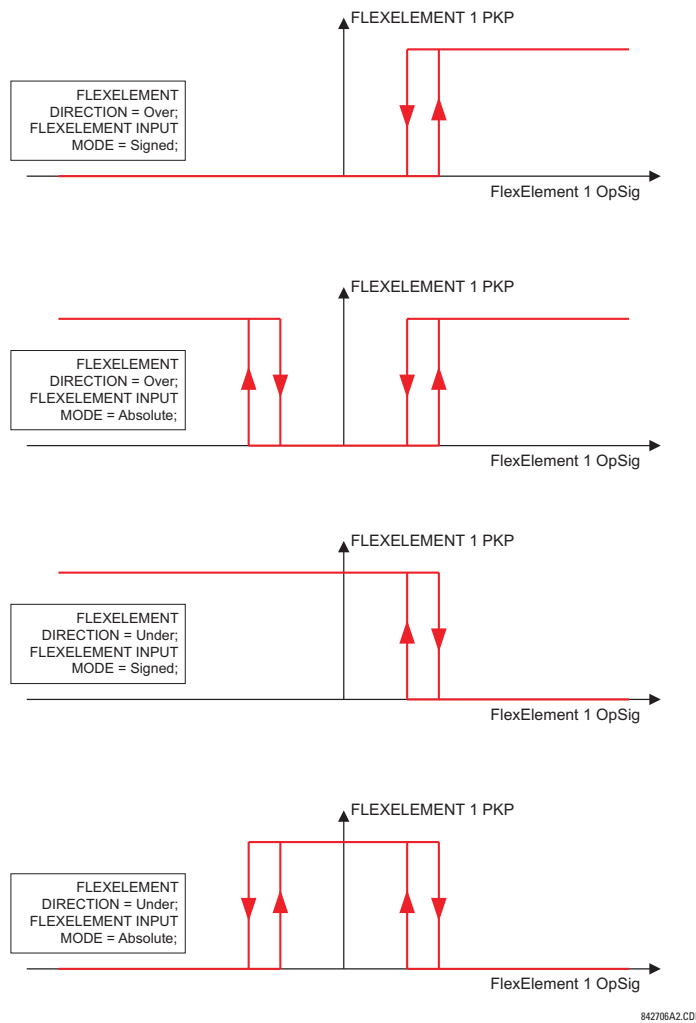

Figure 5–39: FLEXELEMENT™ INPUT MODE SETTING

The **FLEXELEMENT 1 PICKUP** setting specifies the operating threshold for the effective operating signal of the element. If set to “Over”, the element picks up when the operating signal exceeds the **FLEXELEMENT 1 PICKUP** value. If set to “Under”, the element picks up when the operating signal falls below the **FLEXELEMENT 1 PICKUP** value.

The **FLEXELEMENT 1 HYSTERESIS** setting controls the element dropout. It should be noticed that both the operating signal and the pickup threshold can be negative facilitating applications such as reverse power alarm protection. The FlexElement™ can be programmed to work with all analog actual values measured by the relay. The **FLEXELEMENT 1 PICKUP** setting is entered in per-unit values using the following definitions of the base units:

Table 5–11: FLEXELEMENT™ BASE UNITS

dcmA	BASE = maximum value of the DCMA INPUT MAX setting for the two transducers configured under the +IN and –IN inputs.
FREQUENCY	$f_{BASE} = 1 \text{ Hz}$
PHASE ANGLE	$\varphi_{BASE} = 360 \text{ degrees}$ (see the UR angle referencing convention)
POWER FACTOR	$PF_{BASE} = 1.00$
RTDs	BASE = 100°C
SOURCE CURRENT	$I_{BASE} = \text{maximum nominal primary RMS value of the +IN and –IN inputs}$
SOURCE ENERGY (Positive and Negative Watthours, Positive and Negative Varhours)	$E_{BASE} = 10000 \text{ MWh or MVAh, respectively}$
SOURCE POWER	$P_{BASE} = \text{maximum value of } V_{BASE} \times I_{BASE} \text{ for the +IN and –IN inputs}$
SOURCE THD & HARMONICS	BASE = 100% of fundamental frequency component
SOURCE VOLTAGE	$V_{BASE} = \text{maximum nominal primary RMS value of the +IN and –IN inputs}$
VOLTS PER HERTZ	BASE = 1.00 pu
XFMR DIFFERENTIAL CURRENT (Xfmr Iad, Ibd, and Icd Mag)	$I_{BASE} = \text{maximum primary RMS value of the +IN and -IN inputs}$ (CT primary for source currents, and transformer reference primary current for transformer differential currents)
XFMR DIFFERENTIAL HARMONIC CONTENT (Xfmr Harm2 Iad, Ibd, and Icd Mag) (Xfmr Harm5 Iad, Ibd, and Icd Mag)	BASE = 100%
XFMR RESTRAINING CURRENT (Xfmr Iar, Ibr, and Icr Mag)	$I_{BASE} = \text{maximum primary RMS value of the +IN and -IN inputs}$ (CT primary for source currents, and transformer reference primary current for transformer differential currents)

The **FLEXELEMENT 1 HYSTERESIS** setting defines the pickup–dropout relation of the element by specifying the width of the hysteresis loop as a percentage of the pickup value as shown in the FlexElement™ Direction, Pickup, and Hysteresis diagram.

The **FLEXELEMENT 1 DT UNIT** setting specifies the time unit for the setting **FLEXELEMENT 1 dt**. This setting is applicable only if **FLEXELEMENT 1 COMP MODE** is set to “Delta”. The **FLEXELEMENT 1 DT** setting specifies duration of the time interval for the rate of change mode of operation. This setting is applicable only if **FLEXELEMENT 1 COMP MODE** is set to “Delta”.

This **FLEXELEMENT 1 PKP DELAY** setting specifies the pickup delay of the element. The **FLEXELEMENT 1 RST DELAY** setting specifies the reset delay of the element.

5.4.8 NON-VOLATILE LATCHES

PATH: SETTINGS ⇌ FLEXLOGIC ⇌ NON-VOLATILE LATCHES ⇌ LATCH 1(16)

<div style="border: 1px solid black; padding: 2px;"> ■ LATCH 1 ■ </div>	<div style="border: 1px solid black; padding: 2px;"> LATCH 1 FUNCTION: Disabled </div>	Range: Disabled, Enabled
MESSAGE	<div style="border: 1px solid black; padding: 2px;"> LATCH 1 TYPE: Reset Dominant </div>	Range: Reset Dominant, Set Dominant
MESSAGE	<div style="border: 1px solid black; padding: 2px;"> LATCH 1 SET: Off </div>	Range: FlexLogic™ operand
MESSAGE	<div style="border: 1px solid black; padding: 2px;"> LATCH 1 RESET: Off </div>	Range: FlexLogic™ operand
MESSAGE	<div style="border: 1px solid black; padding: 2px;"> LATCH 1 TARGET: Self-reset </div>	Range: Self-reset, Latched, Disabled
MESSAGE	<div style="border: 1px solid black; padding: 2px;"> LATCH 1 EVENTS: Disabled </div>	Range: Disabled, Enabled

The non-volatile latches provide a permanent logical flag that is stored safely and will not reset upon reboot after the relay is powered down. Typical applications include sustaining operator commands or permanently block relay functions, such as Autorecloser, until a deliberate HMI action resets the latch. The settings, logic, and element operation are described below:

- **LATCH 1 TYPE:** This setting characterizes Latch 1 to be Set- or Reset-dominant.
- **LATCH 1 SET:** If asserted, the specified FlexLogic™ operands 'sets' Latch 1.
- **LATCH 1 RESET:** If asserted, the specified FlexLogic™ operand 'resets' Latch 1.

5

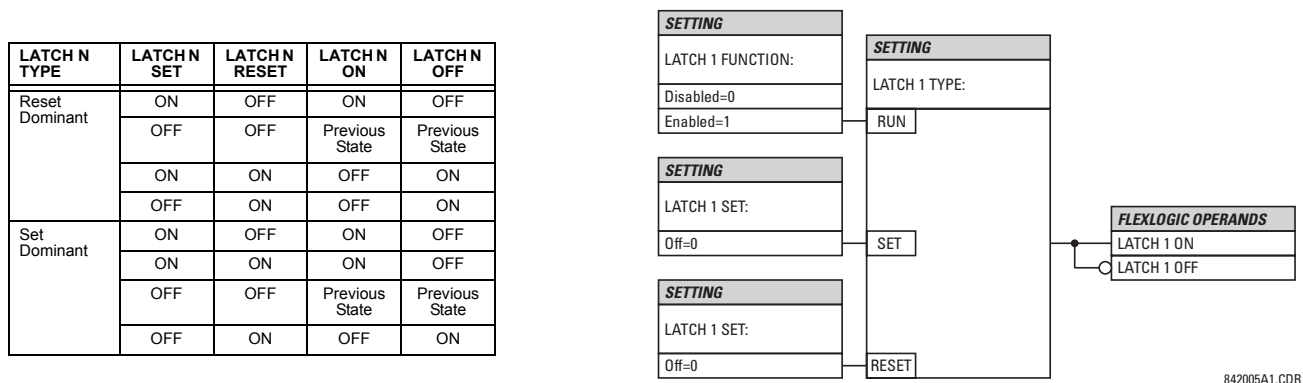

Figure 5–40: NON-VOLATILE LATCH OPERATION TABLE (N=1 to 16) AND LOGIC

5.5.1 OVERVIEW

Each protection element can be assigned up to six different sets of settings according to Setting Group designations 1 to 6. The performance of these elements is defined by the active Setting Group at a given time. Multiple setting groups allow the user to conveniently change protection settings for different operating situations (e.g. altered power system configuration, season of the year). The active setting group can be preset or selected via the **SETTING GROUPS** menu (see the *Control Elements* section later in this chapter). See also the *Introduction to Elements* section at the beginning of this chapter.

5.5.2 SETTING GROUP

PATH: SETTINGS ⇨ ⇩ GROUPED ELEMENTS ⇨ SETTING GROUP 1(6)

■ SETTING GROUP 1 ■	◀▶	■ TRANSFORMER ■	See below.
MESSAGE	▲▼	■ PHASE CURRENT ■	See page 5-96.
MESSAGE	▲▼	■ NEUTRAL CURRENT ■	See page 5-107.
MESSAGE	▲▼	■ GROUND CURRENT ■	See page 5-115.
MESSAGE	▲	■ VOLTAGE ELEMENTS ■	See page 5-122.

Each of the six Setting Group menus is identical. Setting Group 1 (the default active group) automatically becomes active if no other group is active (see the Control Elements section in this chapter for additional details).

5.5.3 TRANSFORMER ELEMENTS

a) MAIN MENU

PATH: SETTINGS ⇨ ⇩ GROUPED ELEMENTS ⇨ SETTING GROUP 1(6) ⇨ TRANSFORMER

■ TRANSFORMER ■	◀▶	■ PERCENT ■ DIFFERENTIAL	See page 5-89.
MESSAGE	▲▼	■ INSTANTANEOUS ■ DIFFERENTIAL	See page 5-92.
MESSAGE	▲▼	■ HOTTEST-SPOT ■ TEMPERATURE	See page 5-93.
MESSAGE	▲▼	■ AGING FACTOR ■	See page 5-94.
MESSAGE	▲	■ LOSS OF LIFE ■	See page 5-95.

This menu contains the settings for the transformer differential elements and the transformer thermal elements.

The thermal elements include hottest-spot temperature, aging factor and loss of life. The computation of these elements follows IEEE standards C57.91-1995: "IEEE Guide for Loading Mineral-Oil-Immersed Transformers" and C57.96-1989: "IEEE Guide for Loading Dry-Type Distribution Transformers". The computations are based on transformer loading conditions, ambient temperature, and the entered transformer data.

b) PERCENT DIFFERENTIAL

PATH: SETTINGS ⇨ ↓ GROUPED ELEMENTS ⇨ SETTING GROUP 1(6) ⇨ TRANSFORMER ⇨ PERCENT DIFFERENTIAL

<input checked="" type="checkbox"/> PERCENT <input checked="" type="checkbox"/> DIFFERENTIAL		PERCENT DIFFERENTIAL FUNCTION: Disabled	Range: Disabled, Enabled
MESSAGE		PERCENT DIFFERENTIAL PICKUP: 0.100 pu	Range: 0.050 to 1.000 pu in steps of 0.001
MESSAGE		PERCENT DIFFERENTIAL SLOPE 1: 25%	Range: 15 to 100% in steps of 1
MESSAGE		PERCENT DIFFERENTIAL BREAK 1: 2.000 pu	Range: 1.000 to 2.000 pu in steps of 0.001
MESSAGE		PERCENT DIFFERENTIAL BREAK 2: 8.000 pu	Range: 2.000 to 30.000 pu in steps of 0.001
MESSAGE		PERCENT DIFFERENTIAL SLOPE 2: 100%	Range: 50 to 100% in steps of 1
MESSAGE		INRUSH INHIBIT FUNCTION: Adapt. 2nd	Range: Disabled, Adapt. 2nd, Trad. 2nd
MESSAGE		INRUSH INHIBIT MODE: Per phase	Range: Per phase, 2-out-of-3, Average
MESSAGE		INRUSH INHIBIT LEVEL: 20.0% fo	Range: 1.0 to 40.0% of fo in steps of 0.1
MESSAGE		OVEREXCITN INHIBIT FUNCTION: Disabled	Range: Disabled, 5th
MESSAGE		OVEREXCITN INHIBIT LEVEL: 10.0% fo	Range: 1.0 to 40.0% of fo in steps of 0.1
MESSAGE		PERCENT DIFF BLOCK: Off	Range: FlexLogic™ operand
MESSAGE		PERCENT DIFFERENTIAL TARGET: Self-reset	Range: Self-reset, Latched, Disabled
MESSAGE		PERCENT DIFFERENTIAL EVENTS: Disabled	Range: Disabled, Enabled

The calculation of differential (I_d) and restraint (I_r) currents for the purposes of the percent differential element is described by the following block diagram, where “Σ” has as its output the vector sum of inputs, and “max” has as its output the input of maximum magnitude; these calculations are performed for each phase.

The differential current is calculated as a vector sum of currents from all windings after magnitude and angle compensation.

$$I_d = \overrightarrow{I_{1_{comp}}} + \dots + \overrightarrow{I_{4_{comp}}} \quad (\text{EQ 5.27})$$

The restraint current is calculated as a maximum of the same internally compensated currents.

$$I_r = \max \cdot (|I_{1_{comp}}|, \dots, |I_{4_{comp}}|) \quad (\text{EQ 5.28})$$

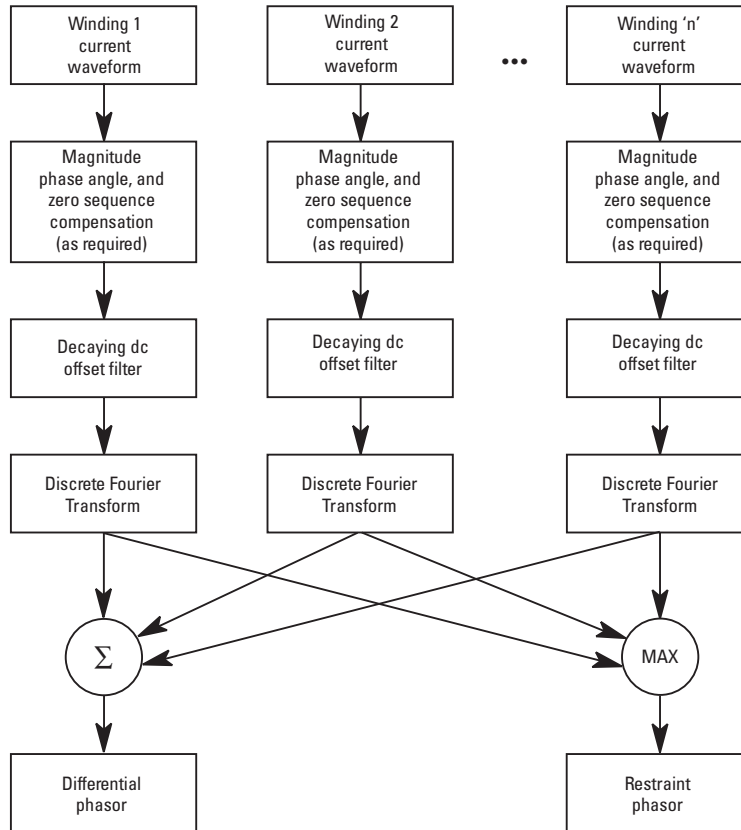

828714A1.CDR

Figure 5-41: PERCENT DIFFERENTIAL CALCULATIONS

The T60 Percent Differential element is based on a configurable dual-breakpoint / dual-slope differential restraint characteristic. The purpose of the preset characteristic is to define the differential restraint ratio for the transformer winding currents at different loading conditions and distinguish between external and internal faults. Differential restraint ratio variations occur due to current unbalance between primary and secondary windings and can be caused by the following:

1. Inherent CT inaccuracies.
2. Onload tap changer operation - it adjusts the transformer ratio and consequently the winding currents.
3. CT saturation.

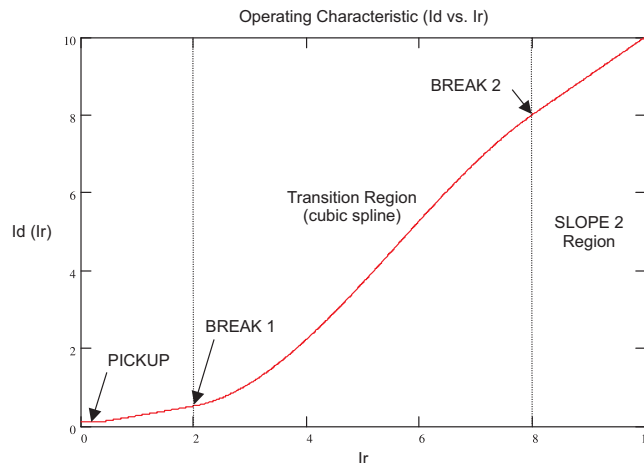
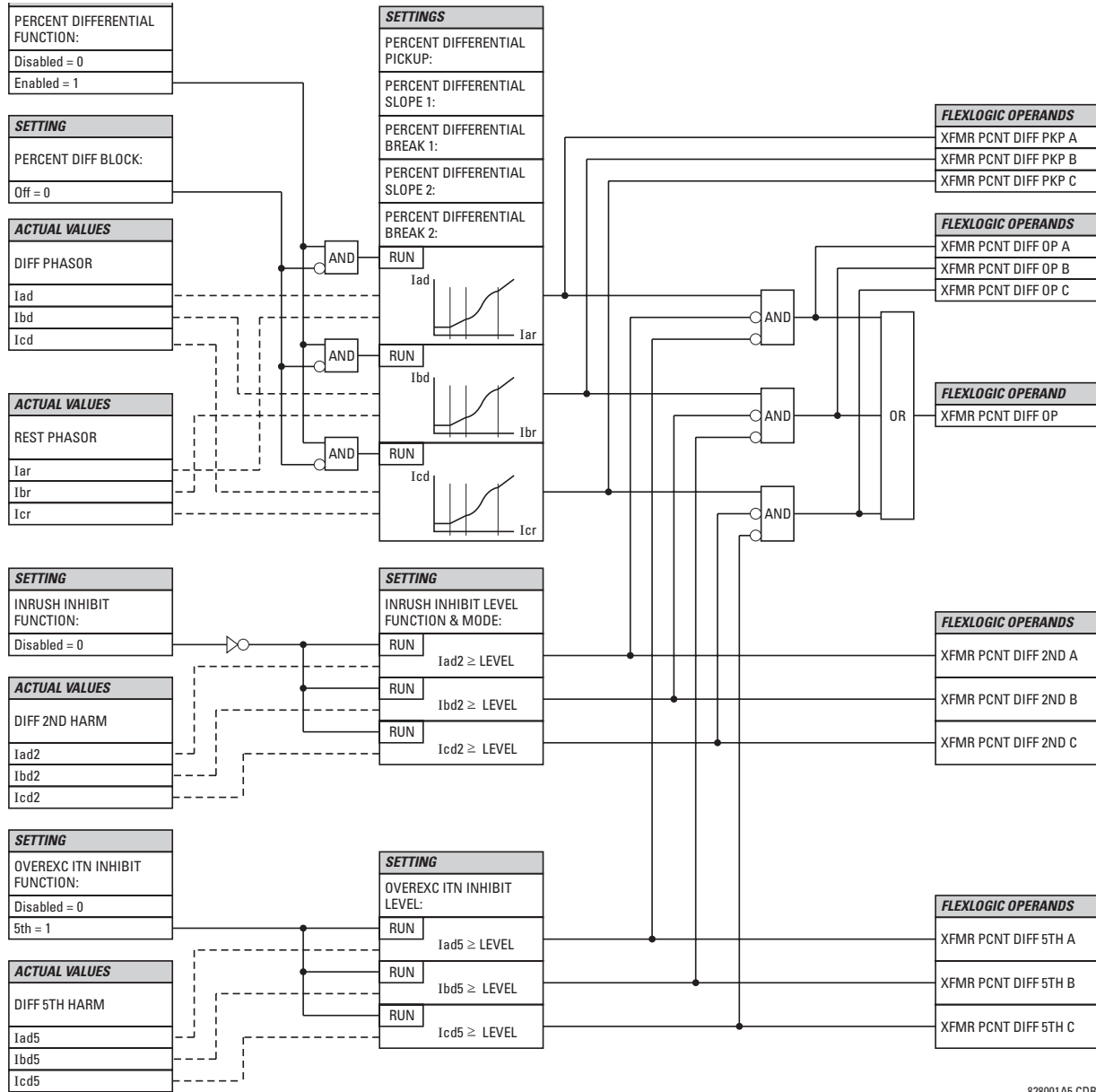

Figure 5-42: PERCENT DIFFERENTIAL OPERATING CHARACTERISTIC

- **PERCENT DIFFERENTIAL PICKUP:** This setting defines the minimum differential current required for operation. It is chosen, based on the amount of differential current that might be seen under normal operating conditions. Two factors may create differential current during the normal transformer operation: errors due to CT inaccuracies and current variation due to on-load tap changer operation.
A setting of 0.1 to 0.3 is generally recommended (the factory default is 0.1 pu).
- **PERCENT DIFFERENTIAL SLOPE 1:** This setting defines the differential restraint during normal operating conditions to assure sensitivity to internal faults. The setting must be high enough, however, to cope with CT saturation errors during saturation under small current magnitudes but significant and long lasting DC components (such as during distant external faults in vicinity of generators).
- **PERCENT DIFFERENTIAL BREAK 1 and BREAK 2:** The settings for Break 1 and Break 2 depend very much on the capability of CTs to correctly transform primary into secondary currents during external faults. Break 2 should be set below the fault current that is most likely to saturate some CTs due to an AC component alone. Break 1 should be set below a current that would cause CT saturation due to DC components and/or residual magnetism. The latter may be as high as 80% of the nominal flux, effectively reducing the CT capabilities by the factor of 5.
- **PERCENT DIFFERENTIAL SLOPE 2:** The Slope 2 setting ensures stability during heavy through fault conditions, where CT saturation results in high differential current. Slope 2 should be set high to cater for the worst case where one set of CTs saturates but the other set doesn't. In such a case the ratio of the differential current to restraint current can be as high as 95 to 98%.
- **INRUSH INHIBIT FUNCTION:** This setting provides a choice for 2nd harmonic differential protection blocking during magnetizing inrush conditions. Two choices are available: "Adapt. 2nd" – adaptive 2nd harmonic, and "Trad. 2nd" – traditional 2nd harmonic blocking. The adaptive 2nd harmonic restraint responds to both magnitudes and phase angles of the 2nd harmonic and the fundamental frequency component. The traditional 2nd harmonic restraint responds to the ratio of magnitudes of the 2nd harmonic and fundamental frequency components. If low second harmonic ratios during magnetizing inrush conditions are not expected, the relay should be set to traditional way of restraining.
- **INRUSH INHIBIT MODE:** This setting specifies mode of blocking on magnetizing inrush conditions. Modern transformers may produce small 2nd harmonic ratios during inrush conditions. This may result in undesired tripping of the protected transformer. Reducing the 2nd harmonic inhibit threshold may jeopardize dependability and speed of protection. The 2nd harmonic ratio, if low, causes problems in one phase only. This may be utilized as a means to ensure security by applying cross-phase blocking rather than lowering the inrush inhibit threshold.
If set to "Per phase", the relay performs inrush inhibit individually in each phase. If used on modern transformers, this setting should be combined with adaptive 2nd harmonic function.
If set to "2-out-of-3", the relay checks 2nd harmonic level in all three phases individually. If any two phases establish a blocking condition, the remaining phase is restrained automatically.
If set to "Average", the relay first calculates the average 2nd harmonic ratio, then applies the inrush threshold to the calculated average. This mode works only in conjunction with the traditional 2nd harmonic function.
- **INRUSH INHIBIT LEVEL:** This setting specifies the level of 2nd harmonic component in the transformer magnetizing inrush current above which the percent differential element will be inhibited from operating. The value of the **INRUSH INHIBIT MODE** setting must be taken into account when programming this value. The **INRUSH INHIBIT LEVEL** is typically set to 20%.
- **OVEREXCITATION INHIBIT MODE:** An overexcitation condition resulting from an increased V/Hz ratio poses a danger to the protected transformer, hence the V/Hz protection. A given transformer can, however, tolerate an overfluxing condition for a limited time, as the danger is associated with thermal processes in the core. Instantaneous tripping of the transformer from the differential protection is not desirable. The relay uses a traditional 5th harmonic ratio for inhibiting its differential function during overexcitation conditions.
- **OVEREXCITATION INHIBIT LEVEL:** This setting is provided to block the differential protection during overexcitation. When the 5th harmonic level exceeds the specified setting (5th harmonic ratio) the differential element is blocked. The overexcitation inhibit works on a per-phase basis.

The relay produces three FlexLogic™ operands that may be used for testing or for special applications such as building custom logic (1-out-of-3) or supervising some protection functions (ground time overcurrent, for example) from the 2nd harmonic inhibit.



828001A5.CDR

Figure 5-43: PERCENT DIFFERENTIAL SCHEME LOGIC

c) INSTANTANEOUS DIFFERENTIAL

PATH: SETTINGS ⇌ GROUPED ELEMENTS ⇌ SETTING GROUP 1(6) ⇌ TRANSFORMER ⇌ INSTANTANEOUS DIFFERENTIAL

<ul style="list-style-type: none"> ■ INSTANTANEOUS ■ DIFFERENTIAL 	<p>MESSAGE</p> <p>MESSAGE</p> <p>MESSAGE</p>	<p>◀▶</p> <p>▲▼</p> <p>▲▼</p> <p>▲▼</p>	<p>INST DIFFERENTIAL FUNCTION: Disabled</p> <p>INST DIFFERENTIAL PICKUP: 8.000 pu</p> <p>INST DIFF BLOCK: Off</p> <p>INST DIFFERENTIAL TARGET: Self-reset</p>	<p>Range: Disabled, Enabled</p> <p>Range: 2.000 to 30.000 pu in steps of 0.001</p> <p>Range: FlexLogic™ operand</p> <p>Range: Self-reset, Latched, Disabled</p>
---	--	---	---	---

MESSAGE  **INST DIFFERENTIAL** *Range: Disabled, Enabled*
EVENTS: Disabled

The Instantaneous Differential element acts as an instantaneous overcurrent element responding to the measured differential current magnitude (filtered fundamental frequency component) and applying a user-selectable pickup threshold. The pickup threshold should be set greater than the maximum spurious differential current that could be encountered under non-internal fault conditions (typically magnetizing inrush current or an external fault with extremely severe CT saturation).

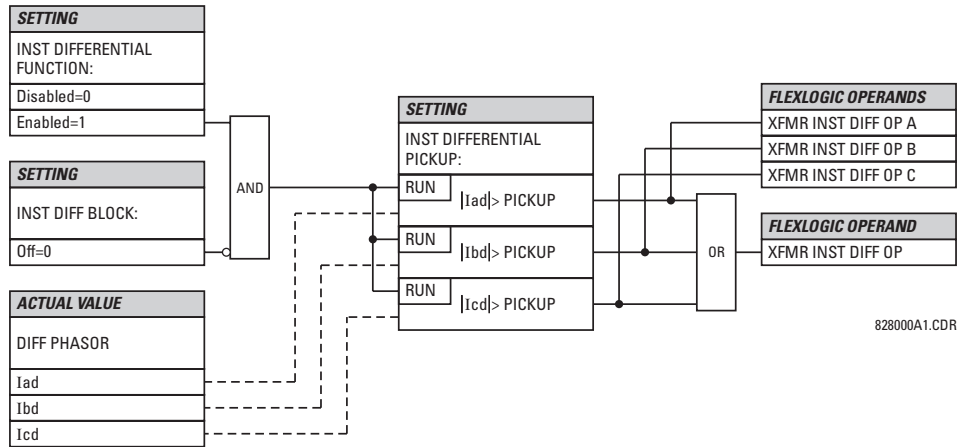







Figure 5-44: INSTANTANEOUS DIFFERENTIAL SCHEME LOGIC



d) HOTTEST-SPOT TEMPERATURE

PATH: SETTINGS ⇨ GROUPED ELEMENTS ⇨ SETTING GROUP 1(6) ⇨ TRANSFORMER ⇨ HOTTEST-SPOT TEMPERATURE

HOTTEST-SPOT TEMPERATURE   *Range: Disabled, Enabled*
XFMR HST FUNCTION: Disabled

MESSAGE   *Range: 50 to 300°C in steps of 1*
XFMR HST PICKUP: 140°C

MESSAGE   *Range: 0 to 30000 min. in steps of 1*
XFMR HST DELAY: 1 min.

MESSAGE   *Range: FlexLogic™ operand*
XFMR HST BLOCK: Off

MESSAGE  *Range: Self-reset, Latched, Disabled*
XFMR HST TARGET: Self-Reset

The Hottest-Spot Temperature element provides a mechanism for detecting abnormal winding hottest-spot temperatures inside the transformer. It can be set to alarm or trip in cases where the computed hottest-spot temperature is above the pickup threshold for a user-specified time (considered as transformer overheating).

- **XFMR HST PICKUP:** Enter the hottest-spot temperature required for operation of the element. This setting should be based on the maximum permissible hottest-spot temperature under emergency transformer loading conditions and maximum ambient temperature.
- **XFMR HST DELAY:** Enter an appropriate time delay before operation of the element.

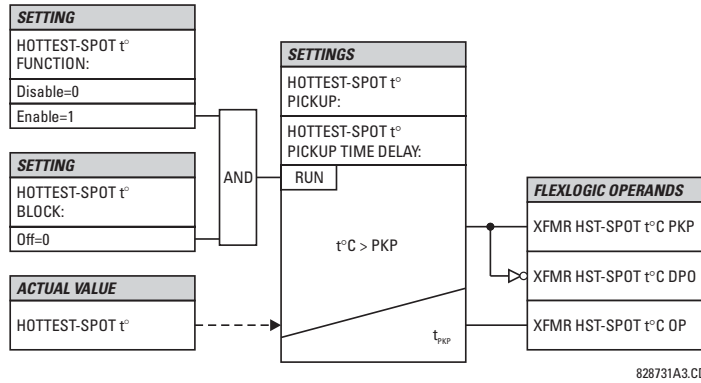

Figure 5-45: TRANSFORMER HOTTEST-SPOT TEMPERATURE LOGIC

e) AGING FACTOR

PATH: SETTINGS ⇄ GROUPED ELEMENTS ⇄ SETTING GROUP 1(6) ⇄ TRANSFORMER ⇄ AGING FACTOR

<div style="border: 1px solid black; padding: 2px;"> <p>■ AGING FACTOR</p> </div>	<div style="border: 1px solid black; padding: 2px;"> <p>AGING FACTOR FUNCTION: Disabled</p> </div> <p>Range: Disabled, Enabled</p>
<p>MESSAGE</p>	<div style="border: 1px solid black; padding: 2px;"> <p>AGING FACTOR PICKUP: 2.0 pu</p> </div> <p>Range: 1.1 to 10.0 pu in steps of 0.1</p>
<p>MESSAGE</p>	<div style="border: 1px solid black; padding: 2px;"> <p>AGING FACTOR DELAY: 10 min.</p> </div> <p>Range: 0 to 30000 min. in steps of 1</p>
<p>MESSAGE</p>	<div style="border: 1px solid black; padding: 2px;"> <p>AGING FACTOR BLOCK: Off</p> </div> <p>Range: FlexLogic™ operand</p>
<p>MESSAGE</p>	<div style="border: 1px solid black; padding: 2px;"> <p>AGING FACTOR TARGET: Self-Reset</p> </div> <p>Range: Self-reset, Latched, Disabled</p>

The Aging Factor element detects transformer aging in per-unit normal insulation aging. The element can be set for alarm or trip whenever the computed aging factor is greater than the user-defined pickup setting for the specified time delay.

- AGING FACTOR PICKUP:** Enter a value above which the aging factor element will operate. The setting should be greater than the maximum permissible aging factor under emergency loading conditions and maximum ambient temperature.

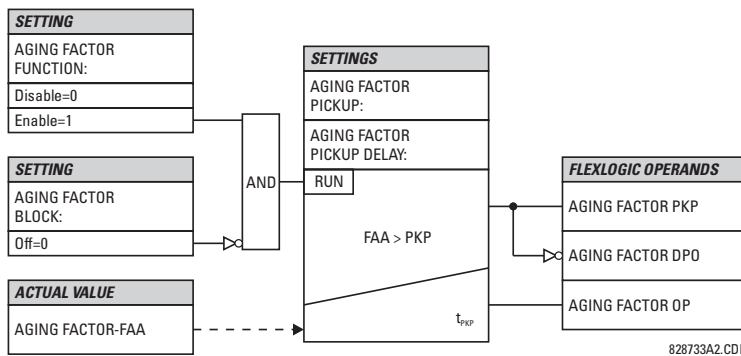

Figure 5-46: AGING FACTOR LOGIC

f) LOSS OF LIFE

PATH: SETTINGS ⇒ GROUPED ELEMENTS ⇒ SETTING GROUP 1(6) ⇒ TRANSFORMER ⇒ LOSS OF LIFE

<div style="border: 1px solid black; padding: 2px;"> ■ LOSS OF LIFE ■ </div>		<div style="border: 1px solid black; padding: 2px;"> LOSS OF LIFE FUNCTION: Disabled </div>	Range: Disabled, Enabled
MESSAGE		<div style="border: 1px solid black; padding: 2px;"> LOSS OF LIFE INITIAL VALUE: 0 hrs </div>	Range: 0 to 500000 hrs. in steps of 1
MESSAGE		<div style="border: 1px solid black; padding: 2px;"> LOSS OF LIFE PICKUP: 180000 hrs </div>	Range: 0 to 500000 hrs. in steps of 1
MESSAGE		<div style="border: 1px solid black; padding: 2px;"> LOSS OF LIFE BLOCK: Off </div>	Range: FlexLogic™ operand
MESSAGE		<div style="border: 1px solid black; padding: 2px;"> LOSS OF LIFE TARGET: Self-Reset </div>	Range: Self-reset, Latched, Disabled

The Loss of Life element detects the accumulated total consumed transformer life. This element can be set to issue an alarm or trip when the actual accumulated transformer life becomes larger than the user-specified loss of life pickup value. For new transformers installations, the **XFMR INITIAL LOSS OF LIFE** setting should be “0”. For previously installed transformers, the user should pre-determine the consumed transformer life in hours.

- **LOSS OF LIFE INITIAL VALUE:** Enter a setting for the consumed transformer life in hours. When the Loss of Life element is enabled, the computed loss of life will be added to the initial loss of life.
- **LOSS OF LIFE PICKUP:** Enter the expended life, in hours, required for operation of the element. This setting should be above the total transformer life set as a reference based on nominal loading conditions and a 30°C ambient temperature, as outlined in the IEEE standards.

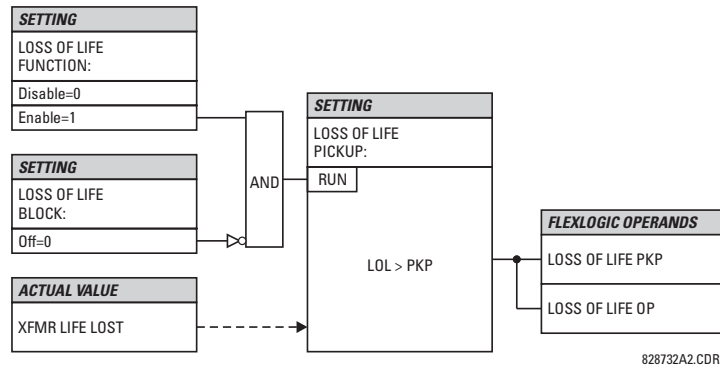
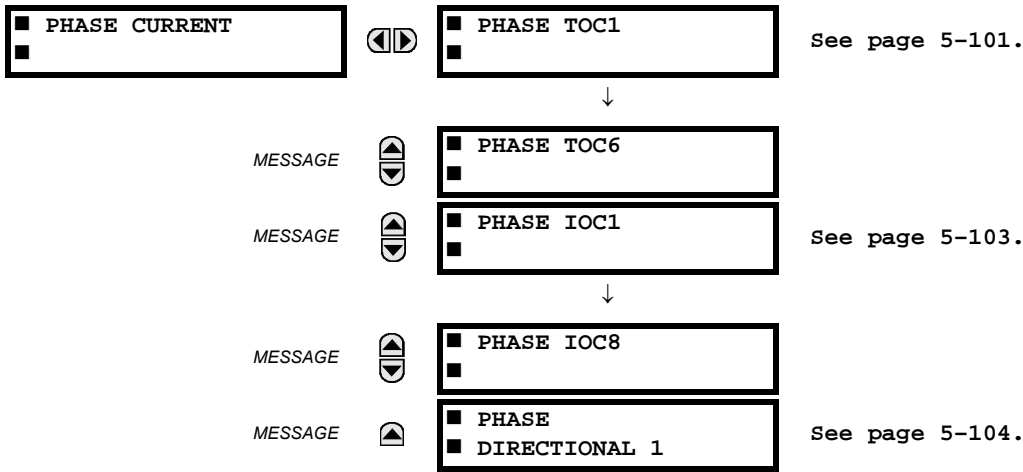

Figure 5–47: TRANSFORMER LOSS OF LIFE LOGIC

5.5.4 PHASE CURRENT

a) MAIN MENU

PATH: SETTINGS ⇌ GROUPED ELEMENTS ⇌ SETTING GROUP 1(6) ⇌ PHASE CURRENT



The Phase Current elements can be used for tripping, alarming, or other functions. The actual number of elements depends on the number of current banks.

b) INVERSE TOC CHARACTERISTICS

The inverse time overcurrent curves used by the time overcurrent elements are the IEEE, IEC, GE Type IAC, and I^2t standard curve shapes. This allows for simplified coordination with downstream devices. If however, none of these curve shapes is adequate, FlexCurves™ may be used to customize the inverse time curve characteristics. The Definite Time curve is also an option that may be appropriate if only simple protection is required.

Table 5-12: OVERCURRENT CURVE TYPES

IEEE	IEC	GE TYPE IAC	OTHER
IEEE Extremely Inv.	IEC Curve A (BS142)	IAC Extremely Inv.	I^2t
IEEE Very Inverse	IEC Curve B (BS142)	IAC Very Inverse	FlexCurves™ A, B, C, and D
IEEE Moderately Inv.	IEC Curve C (BS142)	IAC Inverse	Recloser Curves
	IEC Short Inverse	IAC Short Inverse	Definite Time

A time dial multiplier setting allows selection of a multiple of the base curve shape (where the time dial multiplier = 1) with the curve shape (CURVE) setting. Unlike the electromechanical time dial equivalent, operate times are directly proportional to the time multiplier (TD MULTIPLIER) setting value. For example, all times for a multiplier of 10 are 10 times the multiplier 1 or base curve values. Setting the multiplier to zero results in an instantaneous response to all current levels above pickup.

Time overcurrent time calculations are made with an internal 'energy capacity' memory variable. When this variable indicates that the energy capacity has reached 100%, a time overcurrent element will operate. If less than 100% energy capacity is accumulated in this variable and the current falls below the dropout threshold of 97 to 98% of the pickup value, the variable must be reduced. Two methods of this resetting operation are available: "Instantaneous" and "Timed". The "Instantaneous" selection is intended for applications with other relays, such as most static relays, which set the energy capacity directly to zero when the current falls below the reset threshold. The "Timed" selection can be used where the relay must coordinate with electromechanical relays.

IEEE CURVES:

The IEEE time overcurrent curve shapes conform to industry standards and the IEEE C37.112-1996 curve classifications for extremely, very, and moderately inverse. The IEEE curves are derived from the formulae:

$$T = TDM \times \left[\frac{A}{\left(\frac{I}{I_{pickup}}\right)^p - 1} + B \right], T_{RESET} = TDM \times \left[\frac{t_r}{\left(\frac{I}{I_{pickup}}\right)^2 - 1} \right] \quad (\text{EQ 5.29})$$

where: T = operate time (in seconds), TDM = Multiplier setting, I = input current, I_{pickup} = Pickup Current setting
 A, B, p = constants, T_{RESET} = reset time in seconds (assuming energy capacity is 100% and RESET is "Timed"),
 t_r = characteristic constant

Table 5-13: IEEE INVERSE TIME CURVE CONSTANTS

IEEE CURVE SHAPE	A	B	P	T _R
IEEE Extremely Inverse	28.2	0.1217	2.0000	29.1
IEEE Very Inverse	19.61	0.491	2.0000	21.6
IEEE Moderately Inverse	0.0515	0.1140	0.02000	4.85

Table 5-14: IEEE CURVE TRIP TIMES (IN SECONDS)

MULTIPLIER (TDM)	CURRENT (I / I_{pickup})									
	1.5	2.0	3.0	4.0	5.0	6.0	7.0	8.0	9.0	10.0
IEEE EXTREMELY INVERSE										
0.5	11.341	4.761	1.823	1.001	0.648	0.464	0.355	0.285	0.237	0.203
1.0	22.682	9.522	3.647	2.002	1.297	0.927	0.709	0.569	0.474	0.407
2.0	45.363	19.043	7.293	4.003	2.593	1.855	1.418	1.139	0.948	0.813
4.0	90.727	38.087	14.587	8.007	5.187	3.710	2.837	2.277	1.897	1.626
6.0	136.090	57.130	21.880	12.010	7.780	5.564	4.255	3.416	2.845	2.439
8.0	181.454	76.174	29.174	16.014	10.374	7.419	5.674	4.555	3.794	3.252
10.0	226.817	95.217	36.467	20.017	12.967	9.274	7.092	5.693	4.742	4.065
IEEE VERY INVERSE										
0.5	8.090	3.514	1.471	0.899	0.654	0.526	0.450	0.401	0.368	0.345
1.0	16.179	7.028	2.942	1.798	1.308	1.051	0.900	0.802	0.736	0.689
2.0	32.358	14.055	5.885	3.597	2.616	2.103	1.799	1.605	1.472	1.378
4.0	64.716	28.111	11.769	7.193	5.232	4.205	3.598	3.209	2.945	2.756
6.0	97.074	42.166	17.654	10.790	7.849	6.308	5.397	4.814	4.417	4.134
8.0	129.432	56.221	23.538	14.387	10.465	8.410	7.196	6.418	5.889	5.513
10.0	161.790	70.277	29.423	17.983	13.081	10.513	8.995	8.023	7.361	6.891
IEEE MODERATELY INVERSE										
0.5	3.220	1.902	1.216	0.973	0.844	0.763	0.706	0.663	0.630	0.603
1.0	6.439	3.803	2.432	1.946	1.688	1.526	1.412	1.327	1.260	1.207
2.0	12.878	7.606	4.864	3.892	3.377	3.051	2.823	2.653	2.521	2.414
4.0	25.756	15.213	9.729	7.783	6.753	6.102	5.647	5.307	5.041	4.827
6.0	38.634	22.819	14.593	11.675	10.130	9.153	8.470	7.960	7.562	7.241
8.0	51.512	30.426	19.458	15.567	13.507	12.204	11.294	10.614	10.083	9.654
10.0	64.390	38.032	24.322	19.458	16.883	15.255	14.117	13.267	12.604	12.068

IEC CURVES

For European applications, the relay offers three standard curves defined in IEC 255-4 and British standard BS142. These are defined as IEC Curve A, IEC Curve B, and IEC Curve C. The formulae for these curves are:

$$T = TDM \times \left[\frac{K}{(I/I_{pickup})^E - 1} \right], T_{RESET} = TDM \times \left[\frac{t_r}{(I/I_{pickup})^2 - 1} \right] \quad (\text{EQ 5.30})$$

where: T = operate time (in seconds), TDM = Multiplier setting, I = input current, I_{pickup} = Pickup Current setting, K , E = constants, t_r = characteristic constant, and T_{RESET} = reset time in seconds (assuming energy capacity is 100% and RESET is "Timed")

Table 5–15: IEC (BS) INVERSE TIME CURVE CONSTANTS

IEC (BS) CURVE SHAPE	K	E	T _R
IEC Curve A (BS142)	0.140	0.020	9.7
IEC Curve B (BS142)	13.500	1.000	43.2
IEC Curve C (BS142)	80.000	2.000	58.2
IEC Short Inverse	0.050	0.040	0.500

Table 5–16: IEC CURVE TRIP TIMES (IN SECONDS)

MULTIPLIER (TDM)	CURRENT (I / I _{pickup})									
	1.5	2.0	3.0	4.0	5.0	6.0	7.0	8.0	9.0	10.0
IEC CURVE A										
0.05	0.860	0.501	0.315	0.249	0.214	0.192	0.176	0.165	0.156	0.149
0.10	1.719	1.003	0.630	0.498	0.428	0.384	0.353	0.330	0.312	0.297
0.20	3.439	2.006	1.260	0.996	0.856	0.767	0.706	0.659	0.623	0.594
0.40	6.878	4.012	2.521	1.992	1.712	1.535	1.411	1.319	1.247	1.188
0.60	10.317	6.017	3.781	2.988	2.568	2.302	2.117	1.978	1.870	1.782
0.80	13.755	8.023	5.042	3.984	3.424	3.070	2.822	2.637	2.493	2.376
1.00	17.194	10.029	6.302	4.980	4.280	3.837	3.528	3.297	3.116	2.971
IEC CURVE B										
0.05	1.350	0.675	0.338	0.225	0.169	0.135	0.113	0.096	0.084	0.075
0.10	2.700	1.350	0.675	0.450	0.338	0.270	0.225	0.193	0.169	0.150
0.20	5.400	2.700	1.350	0.900	0.675	0.540	0.450	0.386	0.338	0.300
0.40	10.800	5.400	2.700	1.800	1.350	1.080	0.900	0.771	0.675	0.600
0.60	16.200	8.100	4.050	2.700	2.025	1.620	1.350	1.157	1.013	0.900
0.80	21.600	10.800	5.400	3.600	2.700	2.160	1.800	1.543	1.350	1.200
1.00	27.000	13.500	6.750	4.500	3.375	2.700	2.250	1.929	1.688	1.500
IEC CURVE C										
0.05	3.200	1.333	0.500	0.267	0.167	0.114	0.083	0.063	0.050	0.040
0.10	6.400	2.667	1.000	0.533	0.333	0.229	0.167	0.127	0.100	0.081
0.20	12.800	5.333	2.000	1.067	0.667	0.457	0.333	0.254	0.200	0.162
0.40	25.600	10.667	4.000	2.133	1.333	0.914	0.667	0.508	0.400	0.323
0.60	38.400	16.000	6.000	3.200	2.000	1.371	1.000	0.762	0.600	0.485
0.80	51.200	21.333	8.000	4.267	2.667	1.829	1.333	1.016	0.800	0.646
1.00	64.000	26.667	10.000	5.333	3.333	2.286	1.667	1.270	1.000	0.808
IEC SHORT TIME										
0.05	0.153	0.089	0.056	0.044	0.038	0.034	0.031	0.029	0.027	0.026
0.10	0.306	0.178	0.111	0.088	0.075	0.067	0.062	0.058	0.054	0.052
0.20	0.612	0.356	0.223	0.175	0.150	0.135	0.124	0.115	0.109	0.104
0.40	1.223	0.711	0.445	0.351	0.301	0.269	0.247	0.231	0.218	0.207
0.60	1.835	1.067	0.668	0.526	0.451	0.404	0.371	0.346	0.327	0.311
0.80	2.446	1.423	0.890	0.702	0.602	0.538	0.494	0.461	0.435	0.415
1.00	3.058	1.778	1.113	0.877	0.752	0.673	0.618	0.576	0.544	0.518

IAC CURVES:

The curves for the General Electric type IAC relay family are derived from the formulae:

$$T = TDM \times \left(A + \frac{B}{(I/I_{pkp}) - C} + \frac{D}{((I/I_{pkp}) - C)^2} + \frac{E}{((I/I_{pkp}) - C)^3} \right), T_{RESET} = TDM \times \left[\frac{t_r}{(I/I_{pkp})^2 - 1} \right] \quad (\text{EQ 5.31})$$

where: T = operate time (in seconds), TDM = Multiplier setting, I = Input current, I_{pkp} = Pickup Current setting, A to E = constants, t_r = characteristic constant, and T_{RESET} = reset time in seconds (assuming energy capacity is 100% and RESET is "Timed")

Table 5-17: GE TYPE IAC INVERSE TIME CURVE CONSTANTS

IAC CURVE SHAPE	A	B	C	D	E	T _R
IAC Extreme Inverse	0.0040	0.6379	0.6200	1.7872	0.2461	6.008
IAC Very Inverse	0.0900	0.7955	0.1000	-1.2885	7.9586	4.678
IAC Inverse	0.2078	0.8630	0.8000	-0.4180	0.1947	0.990
IAC Short Inverse	0.0428	0.0609	0.6200	-0.0010	0.0221	0.222

Table 5-18: IAC CURVE TRIP TIMES

MULTIPLIER (TDM)	CURRENT (I / I _{pickup})									
	1.5	2.0	3.0	4.0	5.0	6.0	7.0	8.0	9.0	10.0
IAC EXTREMELY INVERSE										
0.5	1.699	0.749	0.303	0.178	0.123	0.093	0.074	0.062	0.053	0.046
1.0	3.398	1.498	0.606	0.356	0.246	0.186	0.149	0.124	0.106	0.093
2.0	6.796	2.997	1.212	0.711	0.491	0.372	0.298	0.248	0.212	0.185
4.0	13.591	5.993	2.423	1.422	0.983	0.744	0.595	0.495	0.424	0.370
6.0	20.387	8.990	3.635	2.133	1.474	1.115	0.893	0.743	0.636	0.556
8.0	27.183	11.987	4.846	2.844	1.966	1.487	1.191	0.991	0.848	0.741
10.0	33.979	14.983	6.058	3.555	2.457	1.859	1.488	1.239	1.060	0.926
IAC VERY INVERSE										
0.5	1.451	0.656	0.269	0.172	0.133	0.113	0.101	0.093	0.087	0.083
1.0	2.901	1.312	0.537	0.343	0.266	0.227	0.202	0.186	0.174	0.165
2.0	5.802	2.624	1.075	0.687	0.533	0.453	0.405	0.372	0.349	0.331
4.0	11.605	5.248	2.150	1.374	1.065	0.906	0.810	0.745	0.698	0.662
6.0	17.407	7.872	3.225	2.061	1.598	1.359	1.215	1.117	1.046	0.992
8.0	23.209	10.497	4.299	2.747	2.131	1.813	1.620	1.490	1.395	1.323
10.0	29.012	13.121	5.374	3.434	2.663	2.266	2.025	1.862	1.744	1.654
IAC INVERSE										
0.5	0.578	0.375	0.266	0.221	0.196	0.180	0.168	0.160	0.154	0.148
1.0	1.155	0.749	0.532	0.443	0.392	0.360	0.337	0.320	0.307	0.297
2.0	2.310	1.499	1.064	0.885	0.784	0.719	0.674	0.640	0.614	0.594
4.0	4.621	2.997	2.128	1.770	1.569	1.439	1.348	1.280	1.229	1.188
6.0	6.931	4.496	3.192	2.656	2.353	2.158	2.022	1.921	1.843	1.781
8.0	9.242	5.995	4.256	3.541	3.138	2.878	2.695	2.561	2.457	2.375
10.0	11.552	7.494	5.320	4.426	3.922	3.597	3.369	3.201	3.072	2.969
IAC SHORT INVERSE										
0.5	0.072	0.047	0.035	0.031	0.028	0.027	0.026	0.026	0.025	0.025
1.0	0.143	0.095	0.070	0.061	0.057	0.054	0.052	0.051	0.050	0.049
2.0	0.286	0.190	0.140	0.123	0.114	0.108	0.105	0.102	0.100	0.099
4.0	0.573	0.379	0.279	0.245	0.228	0.217	0.210	0.204	0.200	0.197
6.0	0.859	0.569	0.419	0.368	0.341	0.325	0.314	0.307	0.301	0.296
8.0	1.145	0.759	0.559	0.490	0.455	0.434	0.419	0.409	0.401	0.394
10.0	1.431	0.948	0.699	0.613	0.569	0.542	0.524	0.511	0.501	0.493

I²t CURVES:

The curves for the I²t are derived from the formulae:

$$T = \text{TDM} \times \left[\frac{100}{\left(\frac{I}{I_{pickup}}\right)^2} \right], T_{RESET} = \text{TDM} \times \left[\frac{100}{\left(\frac{I}{I_{pickup}}\right)^{-2}} \right] \quad (\text{EQ 5.32})$$

where: T = Operate Time (sec.); TDM = Multiplier Setting; I = Input Current; I_{pickup} = Pickup Current Setting;
 T_{RESET} = Reset Time in sec. (assuming energy capacity is 100% and RESET: Timed)

Table 5–19: I²T CURVE TRIP TIMES

MULTIPLIER (TDM)	CURRENT (I / I_{pickup})									
	1.5	2.0	3.0	4.0	5.0	6.0	7.0	8.0	9.0	10.0
0.01	0.44	0.25	0.11	0.06	0.04	0.03	0.02	0.02	0.01	0.01
0.10	4.44	2.50	1.11	0.63	0.40	0.28	0.20	0.16	0.12	0.10
1.00	44.44	25.00	11.11	6.25	4.00	2.78	2.04	1.56	1.23	1.00
10.00	444.44	250.00	111.11	62.50	40.00	27.78	20.41	15.63	12.35	10.00
100.00	4444.4	2500.0	1111.1	625.00	400.00	277.78	204.08	156.25	123.46	100.00
600.00	26666.7	15000.0	6666.7	3750.0	2400.0	1666.7	1224.5	937.50	740.74	600.00

FLEXCURVES™:

The custom FlexCurves™ are described in detail in the FlexCurves™ section of this chapter. The curve shapes for the FlexCurves™ are derived from the formulae:

$$T = \text{TDM} \times \left[\text{FlexCurve Time at } \left(\frac{I}{I_{pickup}}\right) \right] \quad \text{when } \left(\frac{I}{I_{pickup}}\right) \geq 1.00 \quad (\text{EQ 5.33})$$

$$T_{RESET} = \text{TDM} \times \left[\text{FlexCurve Time at } \left(\frac{I}{I_{pickup}}\right) \right] \quad \text{when } \left(\frac{I}{I_{pickup}}\right) \leq 0.98 \quad (\text{EQ 5.34})$$

where: T = Operate Time (sec.), TDM = Multiplier setting
 I = Input Current, I_{pickup} = Pickup Current setting
 T_{RESET} = Reset Time in seconds (assuming energy capacity is 100% and RESET: Timed)

DEFINITE TIME CURVE:

The Definite Time curve shape operates as soon as the pickup level is exceeded for a specified period of time. The base definite time curve delay is in seconds. The curve multiplier of 0.00 to 600.00 makes this delay adjustable from instantaneous to 600.00 seconds in steps of 10 ms.

$$T = \text{TDM} \quad \text{in seconds, when } I > I_{pickup} \quad (\text{EQ 5.35})$$

$$T_{RESET} = -\text{TDM} \quad \text{in seconds} \quad (\text{EQ 5.36})$$

where: T = Operate Time (sec.), TDM = Multiplier setting
 I = Input Current, I_{pickup} = Pickup Current setting
 T_{RESET} = Reset Time in seconds (assuming energy capacity is 100% and RESET: Timed)

RECLOSER CURVES:

The T60 uses the FlexCurve™ feature to facilitate programming of 41 recloser curves. Please refer to the FlexCurve™ section in this chapter for additional details.

c) PHASE TIME OVERCURRENT (ANSI 51P)

PATH: SETTINGS ⇨ ↓ GROUPED ELEMENTS ⇨ SETTING GROUP 1(6) ⇨ PHASE CURRENT ⇨ PHASE TOC1(4)

■ PHASE TOC1	◀▶	PHASE TOC1 FUNCTION: Disabled	Range: Disabled, Enabled
MESSAGE	▲▼	PHASE TOC1 SIGNAL SOURCE: SRC 1	Range: SRC 1, SRC 2, SRC 3, SRC 4
MESSAGE	▲▼	PHASE TOC1 INPUT: Phasor	Range: Phasor, RMS
MESSAGE	▲▼	PHASE TOC1 PICKUP: 1.000 pu	Range: 0.000 to 30.000 pu in steps of 0.001
MESSAGE	▲▼	PHASE TOC1 CURVE: IEEE Mod Inv	Range: See Overcurrent Curve Types table
MESSAGE	▲▼	PHASE TOC1 TD MULTIPLIER: 1.00	Range: 0.00 to 600.00 in steps of 0.01
MESSAGE	▲▼	PHASE TOC1 RESET: Instantaneous	Range: Instantaneous, Timed
MESSAGE	▲▼	PHASE TOC1 VOLTAGE RESTRAINT: Disabled	Range: Disabled, Enabled
MESSAGE	▲▼	PHASE TOC1 BLOCK A: Off	Range: FlexLogic™ operand
MESSAGE	▲▼	PHASE TOC1 BLOCK B: Off	Range: FlexLogic™ operand
MESSAGE	▲▼	PHASE TOC1 BLOCK C: Off	Range: FlexLogic™ operand
MESSAGE	▲▼	PHASE TOC1 TARGET: Self-reset	Range: Self-reset, Latched, Disabled
MESSAGE	▲	PHASE TOC1 EVENTS: Disabled	Range: Disabled, Enabled

The phase time overcurrent element can provide a desired time-delay operating characteristic versus the applied current or be used as a simple Definite Time element. The phase current input quantities may be programmed as fundamental phasor magnitude or total waveform RMS magnitude as required by the application.

Two methods of resetting operation are available: “Timed” and “Instantaneous” (refer to the *Inverse TOC Curves Characteristic* sub-section earlier for details on curve setup, trip times and reset operation). When the element is blocked, the time accumulator will reset according to the reset characteristic. For example, if the element reset characteristic is set to “Instantaneous” and the element is blocked, the time accumulator will be cleared immediately.

The **PHASE TOC1 PICKUP** setting can be dynamically reduced by a voltage restraint feature (when enabled). This is accomplished via the multipliers (Mvr) corresponding to the phase-phase voltages of the voltage restraint characteristic curve (see the figure below); the pickup level is calculated as ‘Mvr’ times the **PHASE TOC1 PICKUP** setting. If the voltage restraint feature is disabled, the pickup level always remains at the setting value.

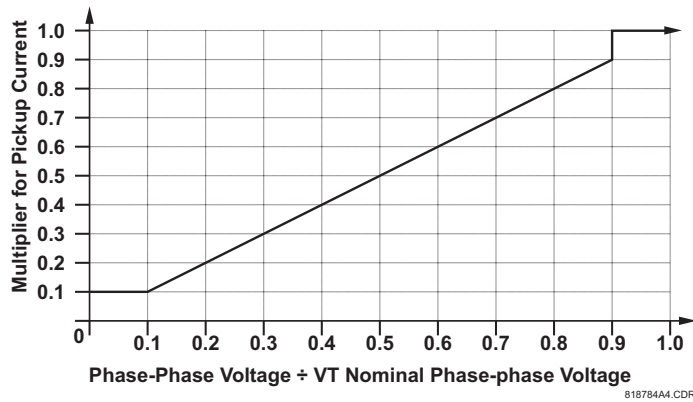

Figure 5-48: PHASE TOC VOLTAGE RESTRAINT CHARACTERISTIC

5

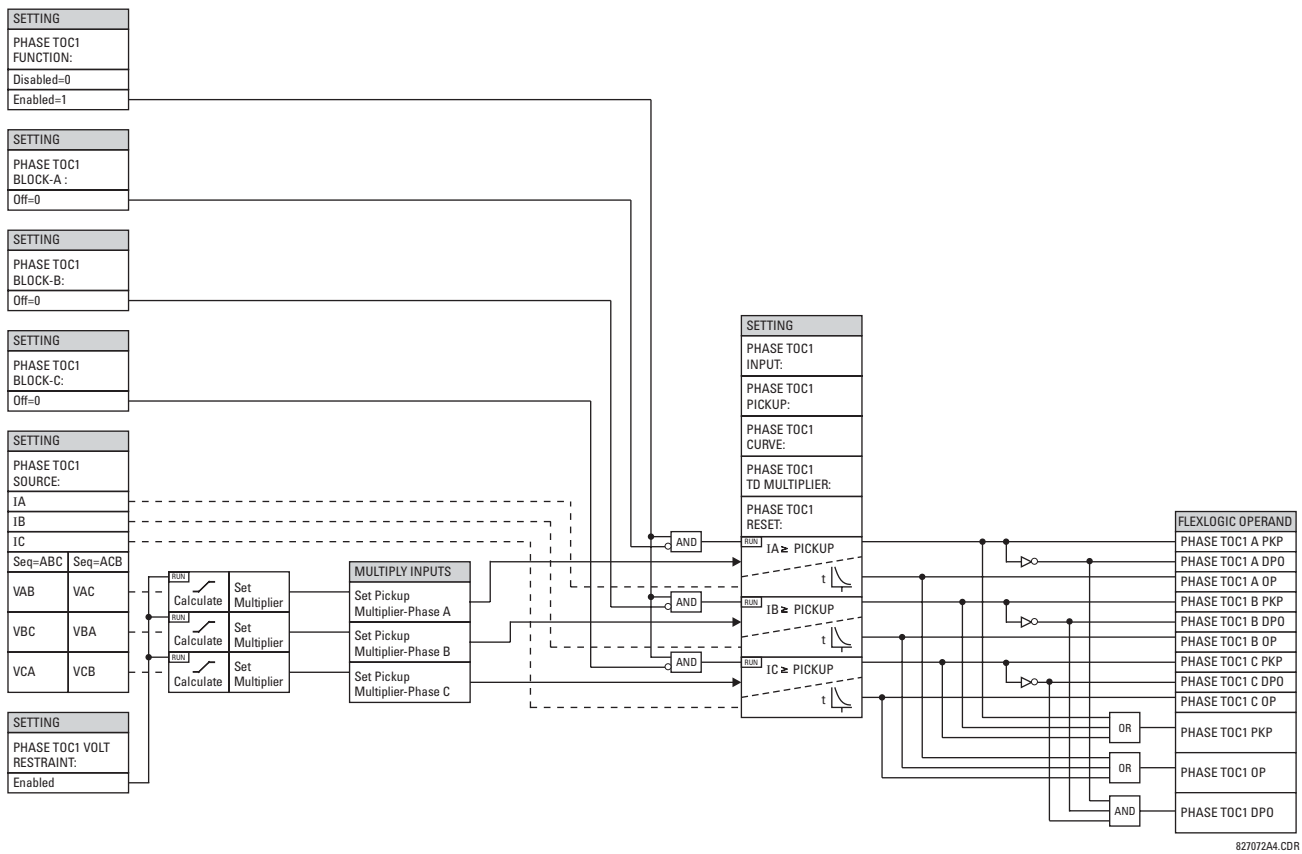

Figure 5-49: PHASE TOC1 SCHEME LOGIC

d) PHASE INSTANTANEOUS OVERCURRENT (ANSI 50P)

PATH: SETTINGS ⇨ GROUPED ELEMENTS ⇨ SETTING GROUP 1(6) ⇨ PHASE CURRENT ⇨ PHASE IOC 1(6)

<div style="border: 1px solid black; padding: 2px;"> ■ PHASE IOC1 ■ </div>	<div style="border: 1px solid black; padding: 2px;"> PHASE IOC1 FUNCTION: Disabled </div>	Range: Disabled, Enabled
MESSAGE	<div style="border: 1px solid black; padding: 2px;"> PHASE IOC1 SIGNAL SOURCE: SRC 1 </div>	Range: SRC 1, SRC 2, SRC 3, SRC 4
MESSAGE	<div style="border: 1px solid black; padding: 2px;"> PHASE IOC1 PICKUP: 1.000 pu </div>	Range: 0.000 to 30.000 pu in steps of 0.001
MESSAGE	<div style="border: 1px solid black; padding: 2px;"> PHASE IOC1 PICKUP DELAY: 0.00 s </div>	Range: 0.00 to 600.00 s in steps of 0.01
MESSAGE	<div style="border: 1px solid black; padding: 2px;"> PHASE IOC1 RESET DELAY: 0.00 s </div>	Range: 0.00 to 600.00 s in steps of 0.01
MESSAGE	<div style="border: 1px solid black; padding: 2px;"> PHASE IOC1 BLOCK A: Off </div>	Range: FlexLogic™ operand
MESSAGE	<div style="border: 1px solid black; padding: 2px;"> PHASE IOC1 BLOCK B: Off </div>	Range: FlexLogic™ operand
MESSAGE	<div style="border: 1px solid black; padding: 2px;"> PHASE IOC1 BLOCK C: Off </div>	Range: FlexLogic™ operand
MESSAGE	<div style="border: 1px solid black; padding: 2px;"> PHASE IOC1 TARGET: Self-reset </div>	Range: Self-reset, Latched, Disabled
MESSAGE	<div style="border: 1px solid black; padding: 2px;"> PHASE IOC1 EVENTS: Disabled </div>	Range: Disabled, Enabled

The phase instantaneous overcurrent element may be used as an instantaneous element with no intentional delay or as a Definite Time element. The input current is the fundamental phasor magnitude.

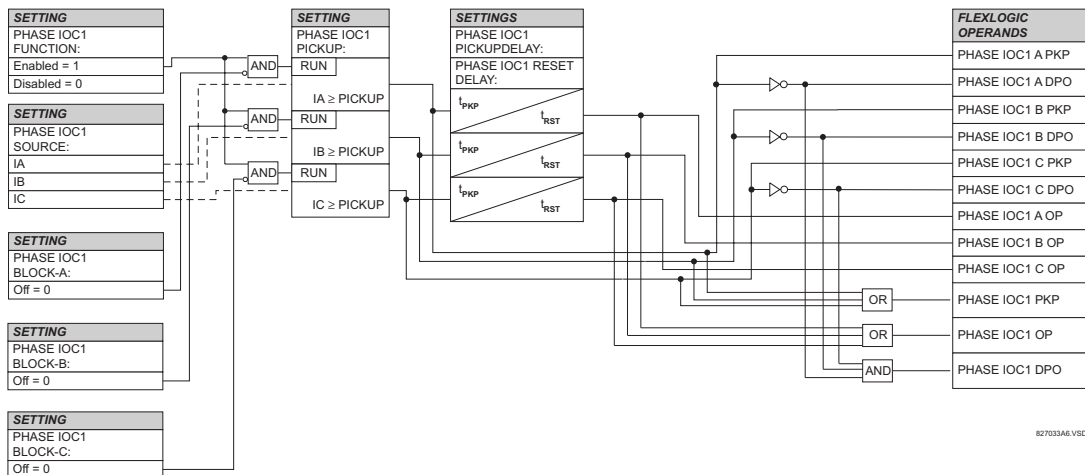

Figure 5-50: PHASE IOC1 SCHEME LOGIC

e) PHASE DIRECTIONAL OVERCURRENT (ANSI 67P)

PATH: SETTINGS ⇨ GROUPED ELEMENTS ⇨ SETTING GROUP 1(6) ⇨ PHASE CURRENT ⇨ PHASE DIRECTIONAL 1

<ul style="list-style-type: none"> ■ PHASE ■ DIRECTIONAL 1 	<p>PHASE DIR 1</p> <p>FUNCTION: Disabled</p>	Range: Disabled, Enabled
MESSAGE	<p>PHASE DIR 1 SIGNAL</p> <p>SOURCE: SRC 1</p>	Range: SRC 1, SRC 2, SRC 3, SRC 4
MESSAGE	<p>PHASE DIR 1 BLOCK:</p> <p>Off</p>	Range: FlexLogic™ operand
MESSAGE	<p>PHASE DIR 1</p> <p>ECA: 30</p>	Range: 0 to 359° in steps of 1
MESSAGE	<p>PHASE DIR POL V1</p> <p>THRESHOLD: 0.700 pu</p>	Range: 0.000 to 3.000 pu in steps of 0.001
MESSAGE	<p>PHASE DIR 1 BLOCK</p> <p>WHEN V MEM EXP: No</p>	Range: No, Yes
MESSAGE	<p>PHASE DIR 1</p> <p>TARGET: Self-reset</p>	Range: Self-reset, Latched, Disabled
MESSAGE	<p>PHASE DIR 1</p> <p>EVENTS: Disabled</p>	Range: Disabled, Enabled

5



Phase Directional 1 target messages not used with the current version of the T60 relay. As a result, the Target settings, for phase directional only, are not applicable.

The phase directional elements (one for each of phases A, B, and C) determine the phase current flow direction for steady state and fault conditions and can be used to control the operation of the phase overcurrent elements via the **BLOCK** inputs of these elements.

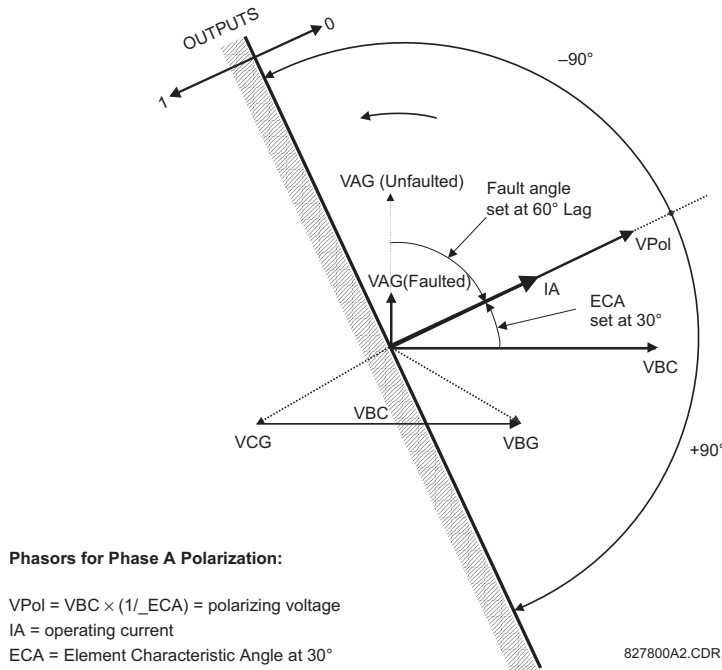

Figure 5-51: PHASE A DIRECTIONAL POLARIZATION

This element is intended to apply a block signal to an overcurrent element to prevent an operation when current is flowing in a particular direction. The direction of current flow is determined by measuring the phase angle between the current from the phase CTs and the line-line voltage from the VTs, based on the 90° or 'quadrature' connection. If there is a requirement to supervise overcurrent elements for flows in opposite directions, such as can happen through a bus-tie breaker, two phase directional elements should be programmed with opposite ECA settings.

To increase security for three phase faults very close to the VTs used to measure the polarizing voltage, a 'voltage memory' feature is incorporated. This feature stores the polarizing voltage the moment before the voltage collapses, and uses it to determine direction. The voltage memory remains valid for one second after the voltage has collapsed.

The main component of the phase directional element is the phase angle comparator with two inputs: the operating signal (phase current) and the polarizing signal (the line voltage, shifted in the leading direction by the characteristic angle, ECA).

The following table shows the operating and polarizing signals used for phase directional control:

PHASE	OPERATING SIGNAL	POLARIZING SIGNAL V_{pol}	
		ABC PHASE SEQUENCE	ACB PHASE SEQUENCE
A	Angle of IA	Angle of VBC $\times (1\angle ECA)$	Angle of VCB $\times (1\angle ECA)$
B	Angle of IB	Angle of VCA $\times (1\angle ECA)$	Angle of VAC $\times 1\angle ECA)$
C	Angle of IC	Angle of VAB $\times (1\angle ECA)$	Angle of VBA $\times (1\angle ECA)$

MODE OF OPERATION:

- When the function is "Disabled", or the operating current is below $5\% \times$ CT nominal, the element output is "0".
- When the function is "Enabled", the operating current is above $5\% \times$ CT nominal, and the polarizing voltage is above the set threshold, the element output is dependent on the phase angle between the operating and polarizing signals:
 - The element output is logic "0" when the operating current is within polarizing voltage $\pm 90^\circ$.
 - For all other angles, the element output is logic "1".
- Once the voltage memory has expired, the phase overcurrent elements under directional control can be set to block or trip on overcurrent as follows:
 - When **BLOCK WHEN V MEM EXP** is set to "Yes", the directional element will block the operation of any phase overcurrent element under directional control when voltage memory expires.
 - When **BLOCK WHEN V MEM EXP** is set to "No", the directional element allows tripping of phase overcurrent elements under directional control when voltage memory expires.

In all cases, directional blocking will be permitted to resume when the polarizing voltage becomes greater than the 'polarizing voltage threshold'.

SETTINGS:

- **PHASE DIR 1 SIGNAL SOURCE:** This setting is used to select the source for the operating and polarizing signals. The operating current for the phase directional element is the phase current for the selected current source. The polarizing voltage is the line voltage from the phase VTs, based on the 90° or 'quadrature' connection and shifted in the leading direction by the element characteristic angle (ECA).
- **PHASE DIR 1 ECA:** This setting is used to select the element characteristic angle, i.e. the angle by which the polarizing voltage is shifted in the leading direction to achieve dependable operation. In the design of the UR-series elements, a block is applied to an element by asserting logic 1 at the blocking input. This element should be programmed via the ECA setting so that the output is **logic 1 for current in the non-tripping direction**.
- **PHASE DIR 1 POL V THRESHOLD:** This setting is used to establish the minimum level of voltage for which the phase angle measurement is reliable. The setting is based on VT accuracy. The default value is "0.700 pu".
- **PHASE DIR 1 BLOCK WHEN V MEM EXP:** This setting is used to select the required operation upon expiration of voltage memory. When set to "Yes", the directional element blocks the operation of any phase overcurrent element under directional control, when voltage memory expires; when set to "No", the directional element allows tripping of phase overcurrent elements under directional control.



The Phase Directional element responds to the forward load current. In the case of a following reverse fault, the element needs some time – in the order of 8 ms – to establish a blocking signal. Some protection elements such as instantaneous overcurrent may respond to reverse faults before the blocking signal is established. Therefore, a coordination time of at least 10 ms must be added to all the instantaneous protection elements under the supervision of the Phase Directional element. If current reversal is of a concern, a longer delay – in the order of 20 ms – may be needed.

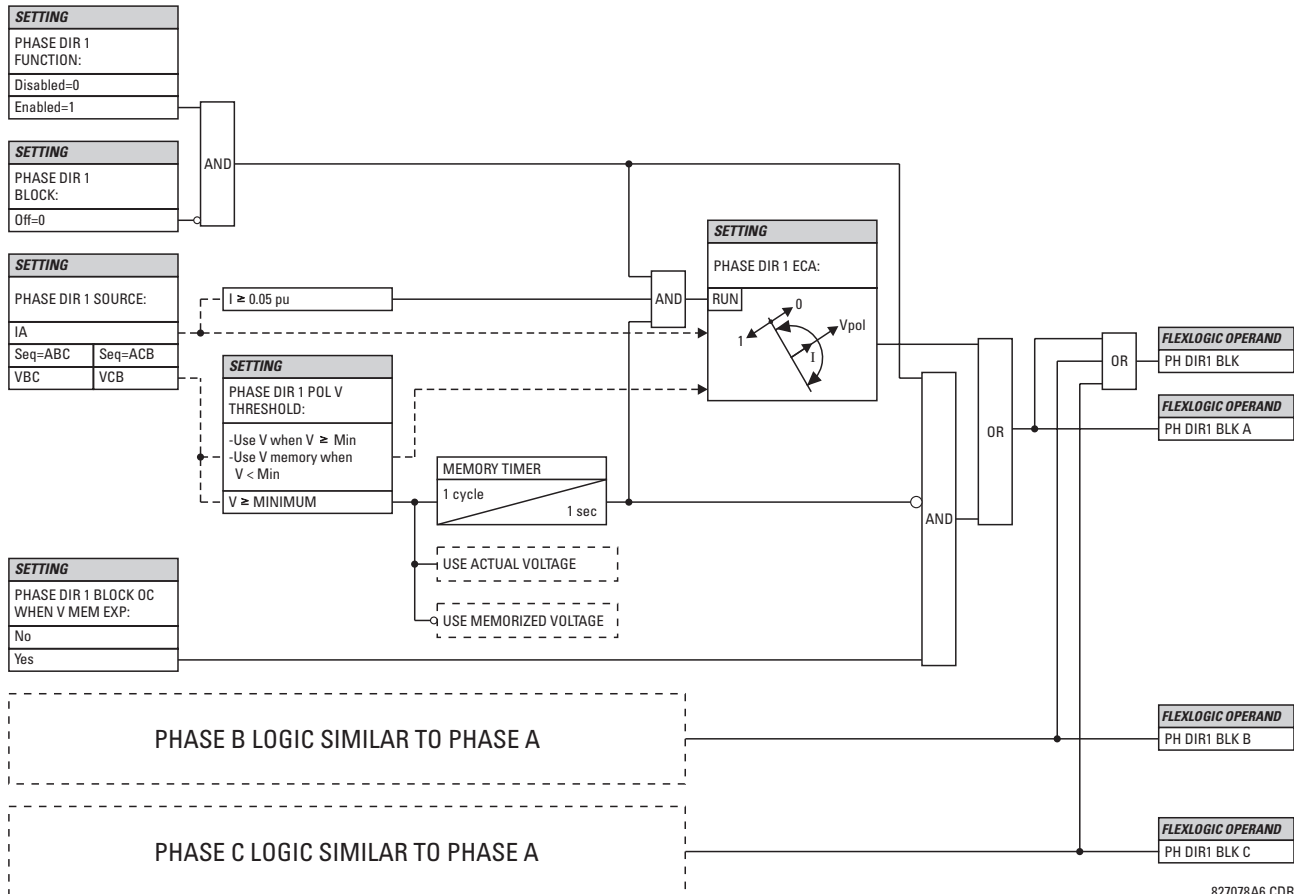

827078A6.CDR

Figure 5–52: PHASE DIRECTIONAL SCHEME LOGIC

5.5.5 NEUTRAL CURRENT

a) MAIN MENU

PATH: SETTINGS ⇨ ↓ GROUPED ELEMENTS ⇨ SETTING GROUP 1(6) ⇨ ↓ NEUTRAL CURRENT

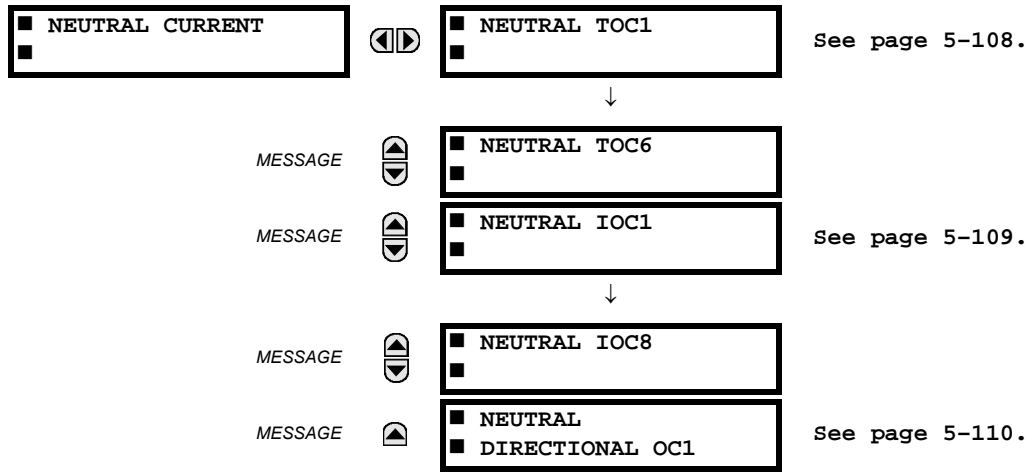

The T60 relay contains six Neutral Time Overcurrent elements, eight Neutral Instantaneous Overcurrent elements, and one Neutral Directional Overcurrent element. For additional information on the Neutral Time Overcurrent curves, refer to Inverse TOC Characteristics on page 5-96.

b) NEUTRAL TIME OVERCURRENT (ANSI 51N)

PATH: SETTINGS ⇨ GROUPED ELEMENTS ⇨ SETTING GROUP 1(6) ⇨ NEUTRAL CURRENT ⇨ NEUTRAL TOC1(6)

■ NEUTRAL TOC1		NEUTRAL TOC1 FUNCTION: Disabled	Range: Disabled, Enabled
MESSAGE	▲▼	NEUTRAL TOC1 SIGNAL SOURCE: SRC 1	Range: SRC 1, SRC 2, SRC 3, SRC 4
MESSAGE	▲▼	NEUTRAL TOC1 INPUT: Phasor	Range: Phasor, RMS
MESSAGE	▲▼	NEUTRAL TOC1 PICKUP: 1.000 pu	Range: 0.000 to 30.000 pu in steps of 0.001
MESSAGE	▲▼	NEUTRAL TOC1 CURVE: IEEE Mod Inv	Range: See OVERCURRENT CURVE TYPES table
MESSAGE	▲▼	NEUTRAL TOC1 TD MULTIPLIER: 1.00	Range: 0.00 to 600.00 in steps of 0.01
MESSAGE	▲▼	NEUTRAL TOC1 RESET: Instantaneous	Range: Instantaneous, Timed
MESSAGE	▲▼	NEUTRAL TOC1 BLOCK: Off	Range: FlexLogic™ operand
MESSAGE	▲▼	NEUTRAL TOC1 TARGET: Self-reset	Range: Self-reset, Latched, Disabled
MESSAGE	▲	NEUTRAL TOC1 EVENTS: Disabled	Range: Disabled, Enabled

5

The Neutral Time Overcurrent element can provide a desired time-delay operating characteristic versus the applied current or be used as a simple Definite Time element. The neutral current input value is a quantity calculated as 3I₀ from the phase currents and may be programmed as fundamental phasor magnitude or total waveform RMS magnitude as required by the application.

Two methods of resetting operation are available: “Timed” and “Instantaneous” (refer to the *Inverse TOC Curve Characteristics* section for details on curve setup, trip times and reset operation). When the element is blocked, the time accumulator will reset according to the reset characteristic. For example, if the element reset characteristic is set to “Instantaneous” and the element is blocked, the time accumulator will be cleared immediately.

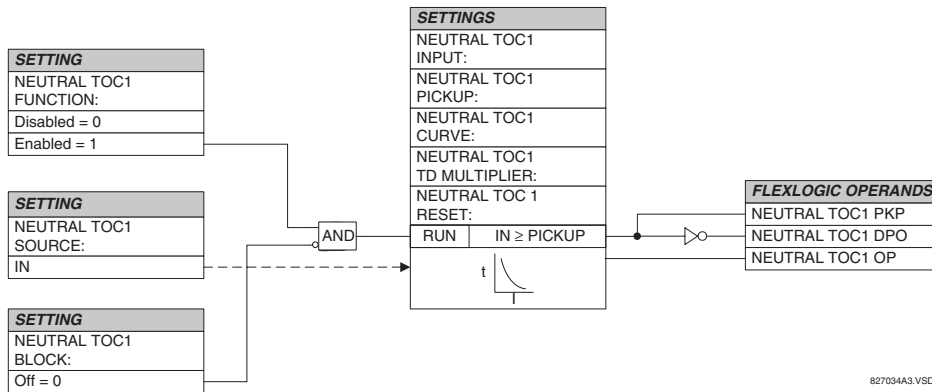

Figure 5-53: NEUTRAL TOC1 SCHEME LOGIC

c) NEUTRAL INSTANTANEOUS OVERCURRENT (ANSI 50N)

PATH: SETTINGS ⇨ GROUPED ELEMENTS ⇨ SETTING GROUP 1(6) ⇨ NEUTRAL CURRENT ⇨ NEUTRAL IOC1(8)

■ NEUTRAL IOC1	◀▶	NEUTRAL IOC1 FUNCTION: Disabled	Range: Disabled, Enabled
MESSAGE	▲▼	NEUTRAL IOC1 SIGNAL SOURCE: SRC 1	Range: SRC 1, SRC 2, SRC 3, SRC 4
MESSAGE	▲▼	NEUTRAL IOC1 PICKUP: 1.000 pu	Range: 0.000 to 30.000 pu in steps of 0.001
MESSAGE	▲▼	NEUTRAL IOC1 PICKUP DELAY: 0.00 s	Range: 0.00 to 600.00 s in steps of 0.01
MESSAGE	▲▼	NEUTRAL IOC1 RESET DELAY: 0.00 s	Range: 0.00 to 600.00 s in steps of 0.01
MESSAGE	▲▼	NEUTRAL IOC1 BLOCK: Off	Range: FlexLogic™ operand
MESSAGE	▲▼	NEUTRAL IOC1 TARGET: Self-reset	Range: Self-reset, Latched, Disabled
MESSAGE	▲	NEUTRAL IOC1 EVENTS: Disabled	Range: Disabled, Enabled

The Neutral Instantaneous Overcurrent element may be used as an instantaneous function with no intentional delay or as a Definite Time function. The element essentially responds to the magnitude of a neutral current fundamental frequency phasor calculated from the phase currents. A “positive-sequence restraint” is applied for better performance. A small portion (6.25%) of the positive-sequence current magnitude is subtracted from the zero-sequence current magnitude when forming the operating quantity of the element as follows:

$$I_{op} = 3 \times (|I_0| - K \cdot |I_1|) \quad \text{where } K = 1/16 \quad \text{(EQ 5.37)}$$

The positive-sequence restraint allows for more sensitive settings by counterbalancing spurious zero-sequence currents resulting from:

- system unbalances under heavy load conditions
- transformation errors of current transformers (CTs) during double-line and three-phase faults
- switch-off transients during double-line and three-phase faults

The positive-sequence restraint must be considered when testing for pickup accuracy and response time (multiple of pickup). The operating quantity depends on how test currents are injected into the relay (single-phase injection: $I_{op} = 0.9375 \cdot I_{injected}$; three-phase pure zero-sequence injection: $I_{op} = 3 \times I_{injected}$).

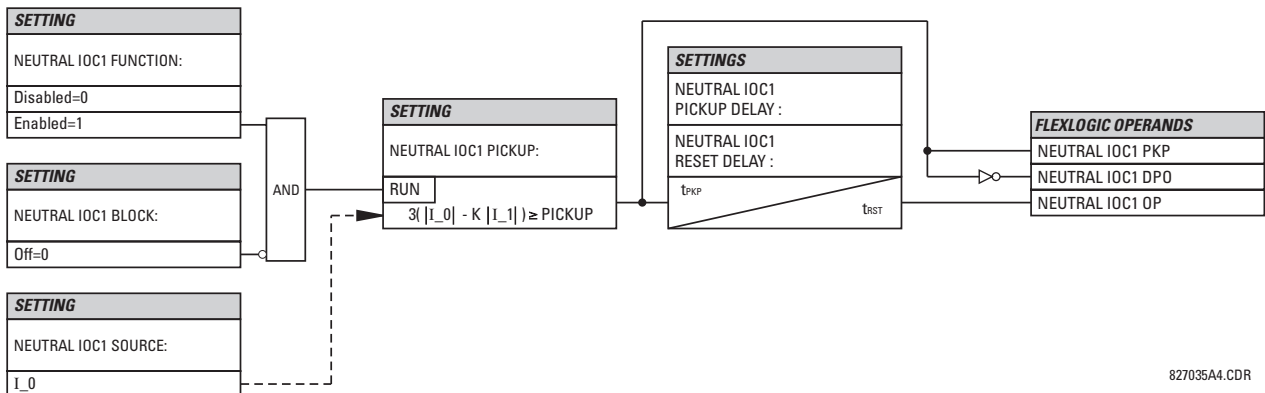

Figure 5–54: NEUTRAL IOC1 SCHEME LOGIC

d) NEUTRAL DIRECTIONAL OVERCURRENT (ANSI 67N)

PATH: SETTINGS ⇨ ↓ GROUPED ELEMENTS ⇨ SETTING GROUP 1(6) ⇨ NEUTRAL CURRENT ⇨ ↓ NEUTRAL DIRECTIONAL OC1

■ NEUTRAL	◀▶	NEUTRAL DIR OC1	Range: Disabled, Enabled
■ DIRECTIONAL OC1		FUNCTION: Disabled	
MESSAGE	▲▼	NEUTRAL DIR OC1	Range: SRC 1, SRC 2, SRC 3, SRC 4
		SOURCE: SRC 1	
MESSAGE	▲▼	NEUTRAL DIR OC1	Range: Voltage, Current, Dual
		POLARIZING: Voltage	
MESSAGE	▲▼	NEUTRAL DIR OC1 POL	Range: Calculated V0, Measured VX
		VOLT: Calculated V0	
MESSAGE	▲▼	NEUTRAL DIR OC1 OP	Range: Calculated 3I0, Measured IG
		CURR: Calculated 3I0	
MESSAGE	▲▼	NEUTRAL DIR OC1 POS-	Range: 0.000 to 0.500 in steps of 0.001
		SEQ RESTRAINT: 0.063	
MESSAGE	▲▼	NEUTRAL DIR OC1	Range: 0.00 to 250.00 Ω in steps of 0.01
		OFFSET: 0.00 Ω	
MESSAGE	▲▼	NEUTRAL DIR OC1 FWD	Range: -90 to 90° in steps of 1
		ECA: 75° Lag	
MESSAGE	▲▼	NEUTRAL DIR OC1 FWD	Range: 40 to 90° in steps of 1
		LIMIT ANGLE: 90°	
MESSAGE	▲▼	NEUTRAL DIR OC1 FWD	Range: 0.002 to 30.000 pu in steps of 0.001
		PICKUP: 0.050 pu	
MESSAGE	▲▼	NEUTRAL DIR OC1 REV	Range: 40 to 90° in steps of 1
		LIMIT ANGLE: 90°	
MESSAGE	▲▼	NEUTRAL DIR OC1 REV	Range: 0.002 to 30.000 pu in steps of 0.001
		PICKUP: 0.050 pu	
MESSAGE	▲▼	NEUTRAL DIR OC1 BLK:	Range: FlexLogic™ operand
		Off	
MESSAGE	▲▼	NEUTRAL DIR OC1	Range: Self-reset, Latched, Disabled
		TARGET: Self-reset	
MESSAGE	▲	NEUTRAL DIR OC1	Range: Disabled, Enabled
		EVENTS: Disabled	

There are two Neutral Directional Overcurrent protection elements available. The element provides both forward and reverse fault direction indications the NEUTRAL DIR OC1 FWD and NEUTRAL DIR OC1 REV operands, respectively. The output operand is asserted if the magnitude of the operating current is above a pickup level (overcurrent unit) and the fault direction is seen as “forward or “reverse”, respectively (directional unit).

The **overcurrent unit** responds to the magnitude of a fundamental frequency phasor of the either the neutral current calculated from the phase currents or the ground current. There are two separate pickup settings for the forward- and reverse-looking functions, respectively. If set to use the calculated 3I₀, the element applies a “positive-sequence restraint” for better performance: a small user-programmable portion of the positive-sequence current magnitude is subtracted from the zero-sequence current magnitude when forming the operating quantity.

$$I_{op} = 3 \times (|I_0| - K \times |I_1|) \quad (\text{EQ 5.38})$$

The positive-sequence restraint allows for more sensitive settings by counterbalancing spurious zero-sequence currents resulting from:

- System unbalances under heavy load conditions.

- Transformation errors of current transformers (CTs) during double-line and three-phase faults.
- Switch-off transients during double-line and three-phase faults.

The positive-sequence restraint must be considered when testing for pickup accuracy and response time (multiple of pickup). The operating quantity depends on the way the test currents are injected into the relay (single-phase injection: $I_{op} = (1 - K) \times I_{injected}$; three-phase pure zero-sequence injection: $I_{op} = 3 \times I_{injected}$).

The positive-sequence restraint is removed for low currents. If the positive-sequence current is below 0.8 pu, the restraint is removed by changing the constant *K* to zero. This facilitates better response to high-resistance faults when the unbalance is very small and there is no danger of excessive CT errors as the current is low.

The **directional unit** uses the zero-sequence current (*I*₀) or ground current (IG) for fault direction discrimination and may be programmed to use either zero-sequence voltage (“Calculated V0” or “Measured VX”), ground current (IG), or both for polarizing. The following tables define the neutral directional overcurrent element.

Table 5–20: QUANTITIES FOR "CALCULATED 3I0" CONFIGURATION

DIRECTIONAL UNIT				OVERCURRENT UNIT
POLARIZING MODE	DIRECTION	COMPARED PHASORS		
Voltage	Forward	$-V_0 + Z_{offset} \times I_0$	$I_0 \times 1 \angle ECA$	$I_{op} = 3 \times (I_0 - K \times I_1)$ if $ I_1 > 0.8$ pu $I_{op} = 3 \times (I_0)$ if $ I_1 \leq 0.8$ pu
	Reverse	$-V_0 + Z_{offset} \times I_0$	$-I_0 \times 1 \angle ECA$	
Current	Forward	IG	I_0	
	Reverse	IG	$-I_0$	
Dual	Forward	$-V_0 + Z_{offset} \times I_0$	$I_0 \times 1 \angle ECA$	
		<i>or</i>		
	Reverse	IG	I_0	
		$-V_0 + Z_{offset} \times I_0$	$-I_0 \times 1 \angle ECA$	
		<i>or</i>		
		IG	$-I_0$	



Table 5–21: QUANTITIES FOR "MEASURED IG" CONFIGURATION

DIRECTIONAL UNIT				OVERCURRENT UNIT
POLARIZING MODE	DIRECTION	COMPARED PHASORS		
Voltage	Forward	$-V_0 + Z_{offset} \times IG/3$	$IG \times 1 \angle ECA$	$I_{op} = IG $
	Reverse	$-V_0 + Z_{offset} \times IG/3$	$-IG \times 1 \angle ECA$	

where: $V_0 = \frac{1}{3}(V_{AG} + V_{BG} + V_{CG}) =$ zero sequence voltage ,

$I_0 = \frac{1}{3}I_N = \frac{1}{3}(I_A + I_B + I_C) =$ zero sequence current ,

ECA = element characteristic angle and IG = ground current

When **NEUTRAL DIR OC1 POL VOLT** is set to “Measured VX”, one-third of this voltage is used in place of *V*₀. The following figure explains the usage of the voltage polarized directional unit of the element.

The figure below shows the voltage-polarized phase angle comparator characteristics for a phase A to ground fault, with:

- ECA = 90° (element characteristic angle = centerline of operating characteristic)
- FWD LA = 80° (forward limit angle = the ± angular limit with the ECA for operation)
- REV LA = 80° (reverse limit angle = the ± angular limit with the ECA for operation)

The above bias should be taken into account when using the neutral directional overcurrent element to directionalize other protection elements.

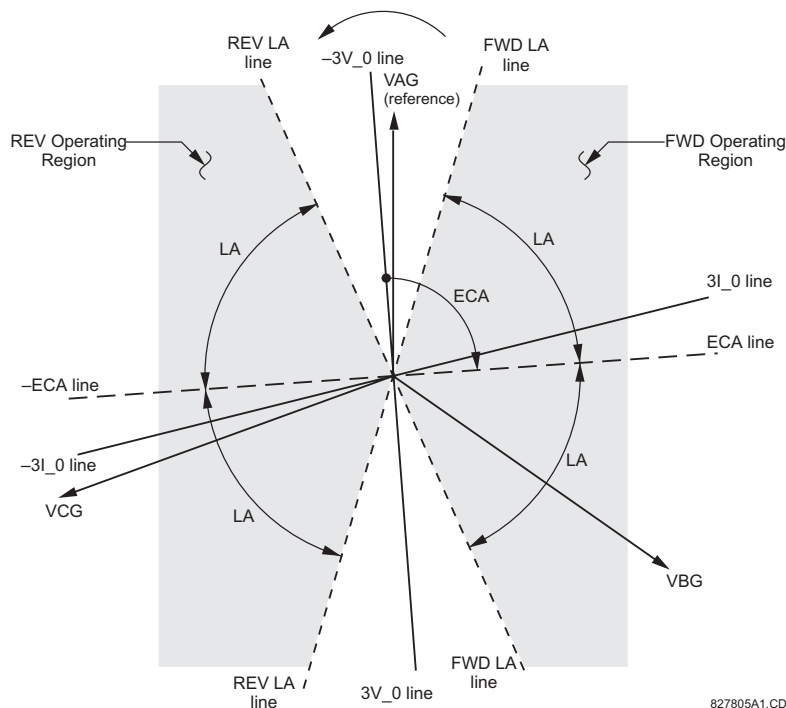
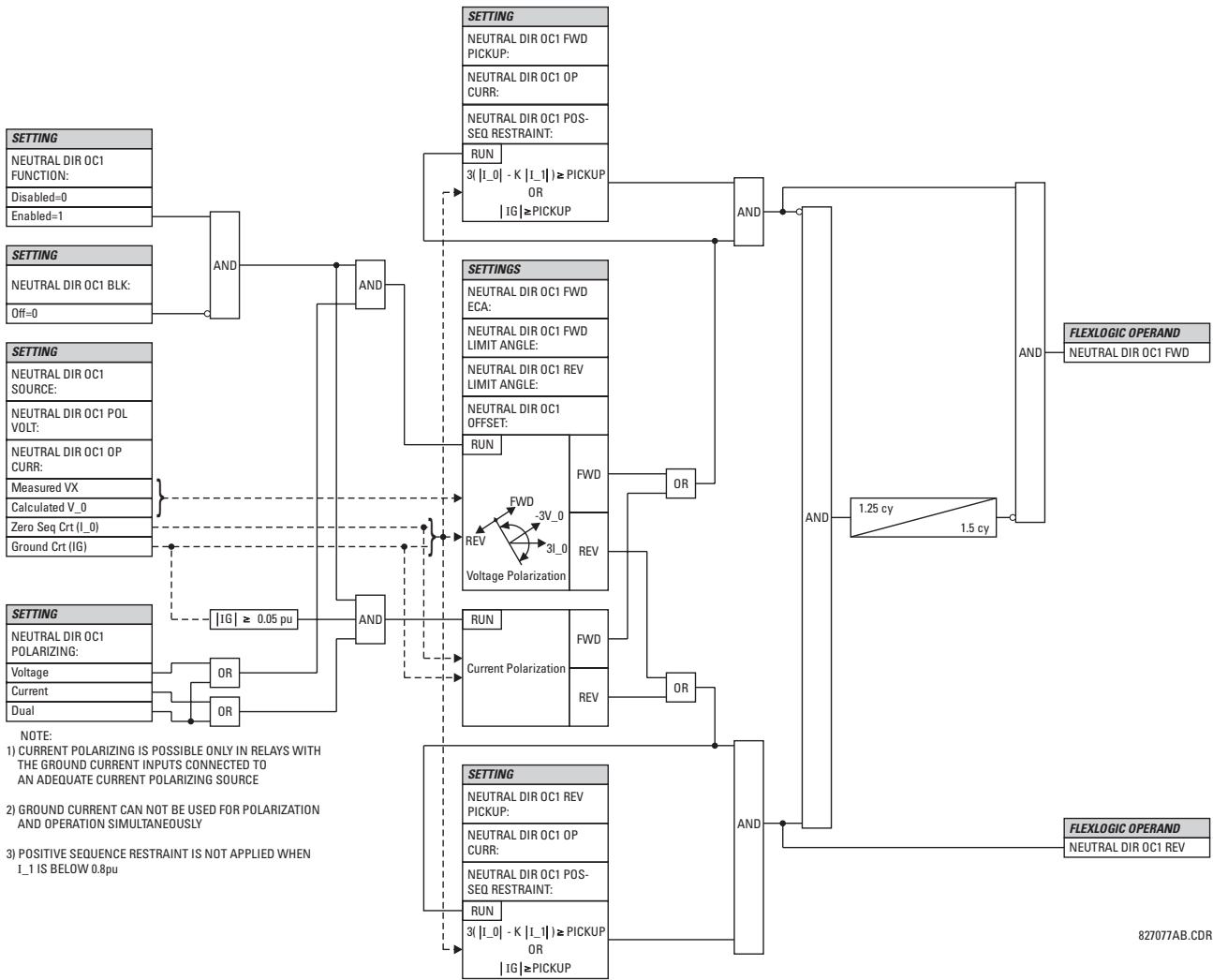

Figure 5-55: NEUTRAL DIRECTIONAL VOLTAGE-POLARIZED CHARACTERISTICS

- **NEUTRAL DIR OC1 POLARIZING:** This setting selects the polarizing mode for the directional unit.
 - If “Voltage” polarizing is selected, the element uses the zero-sequence voltage angle for polarization. The user can use either the zero-sequence voltage V_0 calculated from the phase voltages, or the zero-sequence voltage supplied externally as the auxiliary voltage V_x , both from the **NEUTRAL DIR OC1 SOURCE**.
 The calculated V_0 can be used as polarizing voltage only if the voltage transformers are connected in Wye. The auxiliary voltage can be used as the polarizing voltage provided **SYSTEM SETUP** ⇒ **AC INPUTS** ⇒ **VOLTAGE BANK** ⇒ **AUXILIARY VT CONNECTION** is set to “ V_n ” and the auxiliary voltage is connected to a zero-sequence voltage source (such as open delta connected secondary of VTs).
 The zero-sequence (V_0) or auxiliary voltage (V_x), accordingly, must be higher than 0.02 pu nominal voltage to be validated as a polarizing signal. If the polarizing signal is invalid, neither forward nor reverse indication is given.
 - If “Current” polarizing is selected, the element uses the ground current angle connected externally and configured under **NEUTRAL OC1 SOURCE** for polarization. The Ground CT must be connected between the ground and neutral point of an adequate local source of ground current. The ground current must be higher than 0.05 pu to be validated as a polarizing signal. If the polarizing signal is not valid, neither forward nor reverse indication is given.
 For a choice of current polarizing, it is recommended that the polarizing signal be analyzed to ensure that a known direction is maintained irrespective of the fault location. For example, if using an autotransformer neutral current as a polarizing source, it should be ensured that a reversal of the ground current does not occur for a high-side fault. The low-side system impedance should be assumed minimal when checking for this condition. A similar situation arises for a Wye/Delta/Wye transformer, where current in one transformer winding neutral may reverse when faults on both sides of the transformer are considered.
 - If “Dual” polarizing is selected, the element performs both directional comparisons as described above. A given direction is confirmed if either voltage or current comparators indicate so. If a conflicting (simultaneous forward and reverse) indication occurs, the forward direction overrides the reverse direction.
- **NEUTRAL DIR OC1 POL VOLT:** Selects the polarizing voltage used by the directional unit when “Voltage” or “Dual” polarizing mode is set. The polarizing voltage can be programmed to be either the zero-sequence voltage calculated from the phase voltages (“Calculated V_0 ”) or supplied externally as an auxiliary voltage (“Measured V_X ”).
- **NEUTRAL DIR OC1 OP CURR:** This setting indicates whether the $3I_0$ current calculated from the phase currents, or the ground current shall be used by this protection. This setting acts as a switch between the neutral and ground

modes of operation (67N and 67G). If set to "Calculated 3I0" the element uses the phase currents and applies the positive-sequence restraint; if set to "Measured IG" the element uses ground current supplied to the ground CT of the CT bank configured as **NEUTRAL DIR OC1 SOURCE**. If this setting is "Measured IG", then the **NEUTRAL DIR OC1 POLARIZING** setting must be "Voltage", as it is not possible to use the ground current as an operating and polarizing signal simultaneously.

- **NEUTRAL DIR OC1 POS-SEQ RESTRAINT:** This setting controls the amount of the positive-sequence restraint. Set to 0.063 for backward compatibility with firmware revision 3.40 and older. Set to zero to remove the restraint. Set higher if large system unbalances or poor CT performance are expected.
- **NEUTRAL DIR OC1 OFFSET:** This setting specifies the offset impedance used by this protection. The primary application for the offset impedance is to guarantee correct identification of fault direction on series compensated lines. In regular applications, the offset impedance ensures proper operation even if the zero-sequence voltage at the relaying point is very small. If this is the intent, the offset impedance shall not be larger than the zero-sequence impedance of the protected circuit. Practically, it shall be several times smaller. The offset impedance shall be entered in secondary ohms.
- **NEUTRAL DIR OC1 FWD ECA:** This setting defines the characteristic angle (ECA) for the forward direction in the "Voltage" polarizing mode. The "Current" polarizing mode uses a fixed ECA of 0°. The ECA in the reverse direction is the angle set for the forward direction shifted by 180°.
- **NEUTRAL DIR OC1 FWD LIMIT ANGLE:** This setting defines a symmetrical (in both directions from the ECA) limit angle for the forward direction.
- **NEUTRAL DIR OC1 FWD PICKUP:** This setting defines the pickup level for the overcurrent unit of the element in the forward direction. When selecting this setting it must be kept in mind that the design uses a 'positive-sequence restraint' technique for the "Calculated 3I0" mode of operation.
- **NEUTRAL DIR OC1 REV LIMIT ANGLE:** This setting defines a symmetrical (in both directions from the ECA) limit angle for the reverse direction.
- **NEUTRAL DIR OC1 REV PICKUP:** This setting defines the pickup level for the overcurrent unit of the element in the reverse direction. When selecting this setting it must be kept in mind that the design uses a 'positive-sequence restraint' technique for the "Calculated 3I0" mode of operation.



5

- NOTE:
- 1) CURRENT POLARIZING IS POSSIBLE ONLY IN RELAYS WITH THE GROUND CURRENT INPUTS CONNECTED TO AN ADEQUATE CURRENT POLARIZING SOURCE
 - 2) GROUND CURRENT CAN NOT BE USED FOR POLARIZATION AND OPERATION SIMULTANEOUSLY
 - 3) POSITIVE SEQUENCE RESTRAINT IS NOT APPLIED WHEN I_{L1} IS BELOW 0.8pu

827077AB.CDR

Figure 5-56: NEUTRAL DIRECTIONAL OVERCURRENT LOGIC

a) MAIN MENU

PATH: SETTINGS ⇨ ↓ GROUPED ELEMENTS ⇨ SETTING GROUP 1(6) ⇨ ↓ GROUND CURRENT

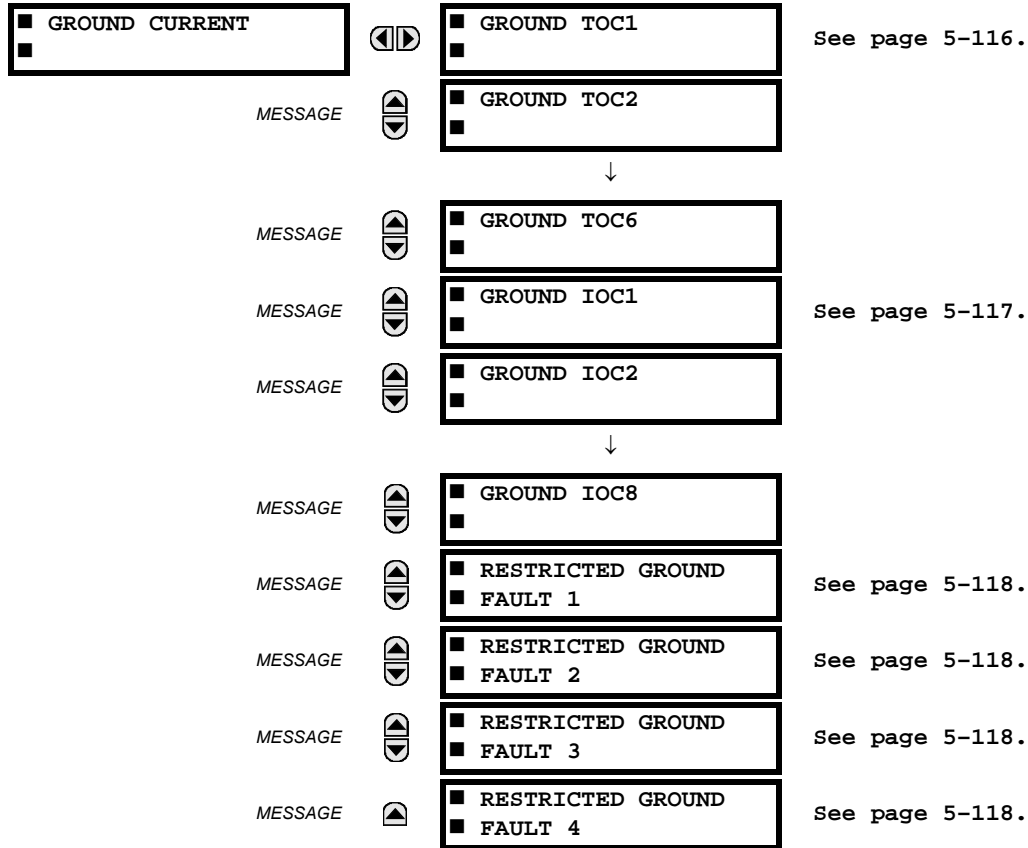

The T60 relay contains six Ground Time Overcurrent elements, eight Ground Instantaneous Overcurrent elements, and four Restricted Ground Fault elements. For additional information on the Ground Time Overcurrent curves, refer to Inverse TOC Characteristics on page 5–96.

b) GROUND TIME OVERCURRENT (ANSI 51G)

PATH: SETTINGS ⇨ ↓ GROUPED ELEMENTS ⇨ SETTING GROUP 1(6) ⇨ ↓ GROUND CURRENT ⇨ GROUND TOC1(6)

■ GROUND TOC1	◀▶	GROUND TOC1 FUNCTION: Disabled	Range: Disabled, Enabled
MESSAGE	▲▼	GROUND TOC1 SIGNAL SOURCE: SRC 1	Range: SRC 1, SRC 2, SRC 3, SRC 4
MESSAGE	▲▼	GROUND TOC1 INPUT: Phasor	Range: Phasor, RMS
MESSAGE	▲▼	GROUND TOC1 PICKUP: 1.000 pu	Range: 0.000 to 30.000 pu in steps of 0.001
MESSAGE	▲▼	GROUND TOC1 CURVE: IEEE Mod Inv	Range: see the Overcurrent Curve Types table
MESSAGE	▲▼	GROUND TOC1 TD MULTIPLIER: 1.00	Range: 0.00 to 600.00 in steps of 0.01
MESSAGE	▲▼	GROUND TOC1 RESET: Instantaneous	Range: Instantaneous, Timed
MESSAGE	▲▼	GROUND TOC1 BLOCK: Off	Range: FlexLogic™ operand
MESSAGE	▲▼	GROUND TOC1 TARGET: Self-reset	Range: Self-reset, Latched, Disabled
MESSAGE	▲	GROUND TOC1 EVENTS: Disabled	Range: Disabled, Enabled

5

This element can provide a desired time-delay operating characteristic versus the applied current or be used as a simple Definite Time element. The ground current input value is the quantity measured by the ground input CT and is the fundamental phasor or RMS magnitude. Two methods of resetting operation are available; “Timed” and “Instantaneous” (refer to the *Inverse Time Overcurrent Curve Characteristics* section for details). When the element is blocked, the time accumulator will reset according to the reset characteristic. For example, if the element reset characteristic is set to “Instantaneous” and the element is blocked, the time accumulator will be cleared immediately.



These elements measure the current that is connected to the ground channel of a CT/VT module. This channel may be equipped with a standard or sensitive input. The conversion range of a standard channel is from 0.02 to 46 times the CT rating. The conversion range of a sensitive channel is from 0.002 to 4.6 times the CT rating.

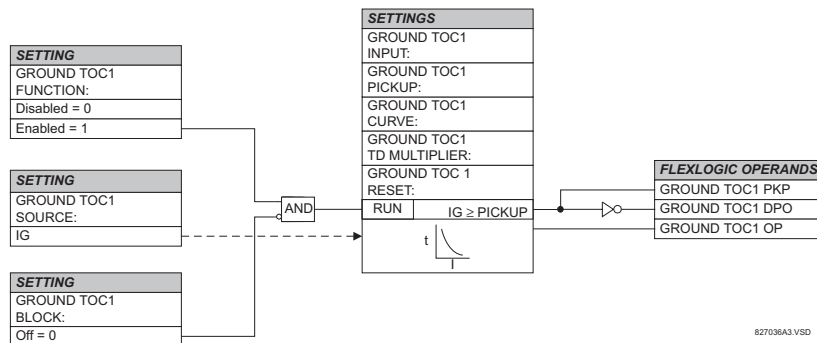

Figure 5-57: GROUND TOC1 SCHEME LOGIC

c) GROUND INSTANTANEOUS OVERCURRENT (ANSI 50G)

PATH: SETTINGS ⇨ GROUPED ELEMENTS ⇨ SETTING GROUP 1(6) ⇨ GROUND CURRENT ⇨ GROUND IOC1(8)

<div style="border: 1px solid black; padding: 2px;"> ■ GROUND IOC1 ■ </div>	<div style="border: 1px solid black; padding: 2px;"> GROUND IOC1 FUNCTION: Disabled </div>	Range: Disabled, Enabled
MESSAGE	<div style="border: 1px solid black; padding: 2px;"> GROUND IOC1 SIGNAL SOURCE: SRC 1 </div>	Range: SRC 1, SRC 2, SRC 3, SRC 4
MESSAGE	<div style="border: 1px solid black; padding: 2px;"> GROUND IOC1 PICKUP: 1.000 pu </div>	Range: 0.000 to 30.000 pu in steps of 0.001
MESSAGE	<div style="border: 1px solid black; padding: 2px;"> GROUND IOC1 PICKUP DELAY: 0.00 s </div>	Range: 0.00 to 600.00 s in steps of 0.01
MESSAGE	<div style="border: 1px solid black; padding: 2px;"> GROUND IOC1 RESET DELAY: 0.00 s </div>	Range: 0.00 to 600.00 s in steps of 0.01
MESSAGE	<div style="border: 1px solid black; padding: 2px;"> GROUND IOC1 BLOCK: Off </div>	Range: FlexLogic™ operand
MESSAGE	<div style="border: 1px solid black; padding: 2px;"> GROUND IOC1 TARGET: Self-reset </div>	Range: Self-reset, Latched, Disabled
MESSAGE	<div style="border: 1px solid black; padding: 2px;"> GROUND IOC1 EVENTS: Disabled </div>	Range: Disabled, Enabled

The Ground Instantaneous Overcurrent element may be used as an instantaneous element with no intentional delay or as a Definite Time element. The ground current input is the quantity measured by the ground input CT and is the fundamental phasor magnitude.

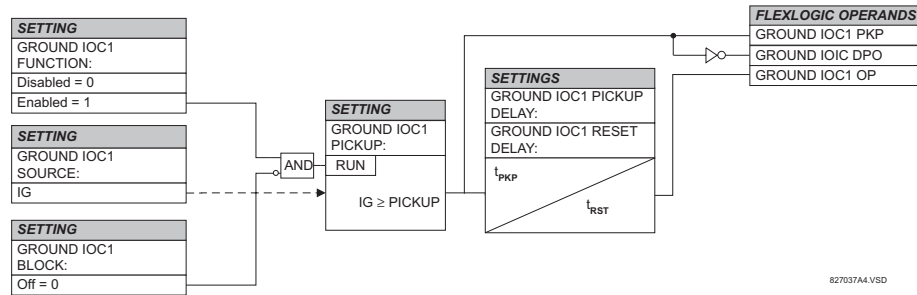

Figure 5-58: GROUND IOC1 SCHEME LOGIC



These elements measure the current that is connected to the ground channel of a CT/VT module. This channel may be equipped with a standard or sensitive input. The conversion range of a standard channel is from 0.02 to 46 times the CT rating. The conversion range of a sensitive channel is from 0.002 to 4.6 times the CT rating.

d) RESTRICTED GROUND FAULT (ANSI 87G)

PATH: SETTINGS ⇨ GROUPED ELEMENTS ⇨ SETTING GROUP 1(6) ⇨ GROUND CURRENT ⇨ RESTRICTED GROUND FAULT 1(4)

<ul style="list-style-type: none"> ■ RESTRICTED GROUND ■ FAULT 1 	<div style="text-align: center;">◀▶</div>	RESTD GND FT1 FUNCTION: Disabled	Range: Disabled, Enabled
MESSAGE	<div style="text-align: center;">▲▼</div>	RESTD GND FT1 SOURCE: SRC 1	Range: SRC 1, SRC 2, SRC 3, SRC 4
MESSAGE	<div style="text-align: center;">▲▼</div>	RESTD GND FT1 PICKUP: 0.080 pu	Range: 0.000 to 30.000 pu in steps of 0.001
MESSAGE	<div style="text-align: center;">▲▼</div>	RESTD GND FT1 SLOPE: 40%	Range: 0 to 100% in steps of 1
MESSAGE	<div style="text-align: center;">▲▼</div>	RESTD GND FT1 PICKUP DELAY: 0.10 s	Range: 0.00 to 600.00 s in steps of 0.01
MESSAGE	<div style="text-align: center;">▲▼</div>	RESTD GND FT1 RESET DELAY: 0.00 s	Range: 0.00 to 600.00 s in steps of 0.01
MESSAGE	<div style="text-align: center;">▲▼</div>	RESTD GND FT1 BLOCK: Off	Range: FlexLogic™ operand
MESSAGE	<div style="text-align: center;">▲▼</div>	RESTD GND FT1 TARGET: Self-reset	Range: Self-reset, Latched, Disabled
MESSAGE	<div style="text-align: center;">▲</div>	RESTD GND FT1 EVENTS: Disabled	Range: Disabled, Enabled

5



As of T60 firmware revision 3.20, the definition of the restraining signal has been significantly changed compared to previous versions. The restraint during external faults is generally not lower, and often much higher, compared to the previous definition of the restraining signal (enhanced security). The restraint on internal faults has been greatly reduced compared to previous versions (enhanced sensitivity), particularly during low-current internal faults. Using time delay as a means of dealing with CT saturation is no longer obligatory; pickup and slope are the primary means of addressing CT saturation. Increasing the slope setting is recommended when migrating from the 3.1x or earlier firmware revisions. The default value for the slope has been changed from 10% to 40%.

Restricted Ground Fault (RGF) protection provides sensitive ground fault detection for low-magnitude fault currents, primarily faults close to the neutral point of a Wye-connected winding. An internal ground fault on an impedance grounded Wye winding will produce a fault current dependent on the ground impedance value and the fault position on the winding with respect to the neutral point. The resultant primary current will be negligible for faults on the lower 30% of the winding since the fault voltage is not the system voltage, but rather the result of the transformation ratio between the primary windings and the percentage of shorted turns on the secondary. Therefore, the resultant differential currents may be below the slope threshold of the main differential element and the fault could go undetected. Application of the RGF protection extends the coverage towards the neutral point (see the RGF and Percent Differential Zones of Protection diagram).

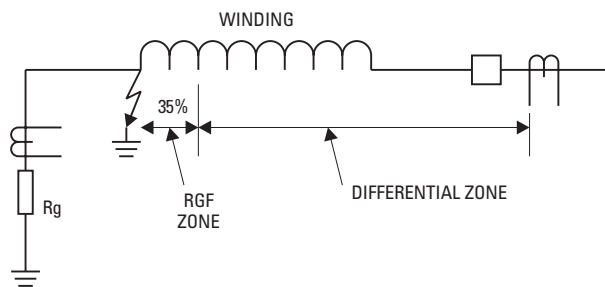

842731A1.CDR

Figure 5–59: RGF AND PERCENT DIFFERENTIAL ZONES OF PROTECTION

This protection is often applied to transformers having impedance-grounded Wye windings. The element may also be applied to the stator winding of a generator having the neutral point grounded with a CT installed in the grounding path, or the ground current obtained by external summation of the neutral-side stator CTs. The Typical Applications of RGF Protection diagram explains the basic application and wiring rules.

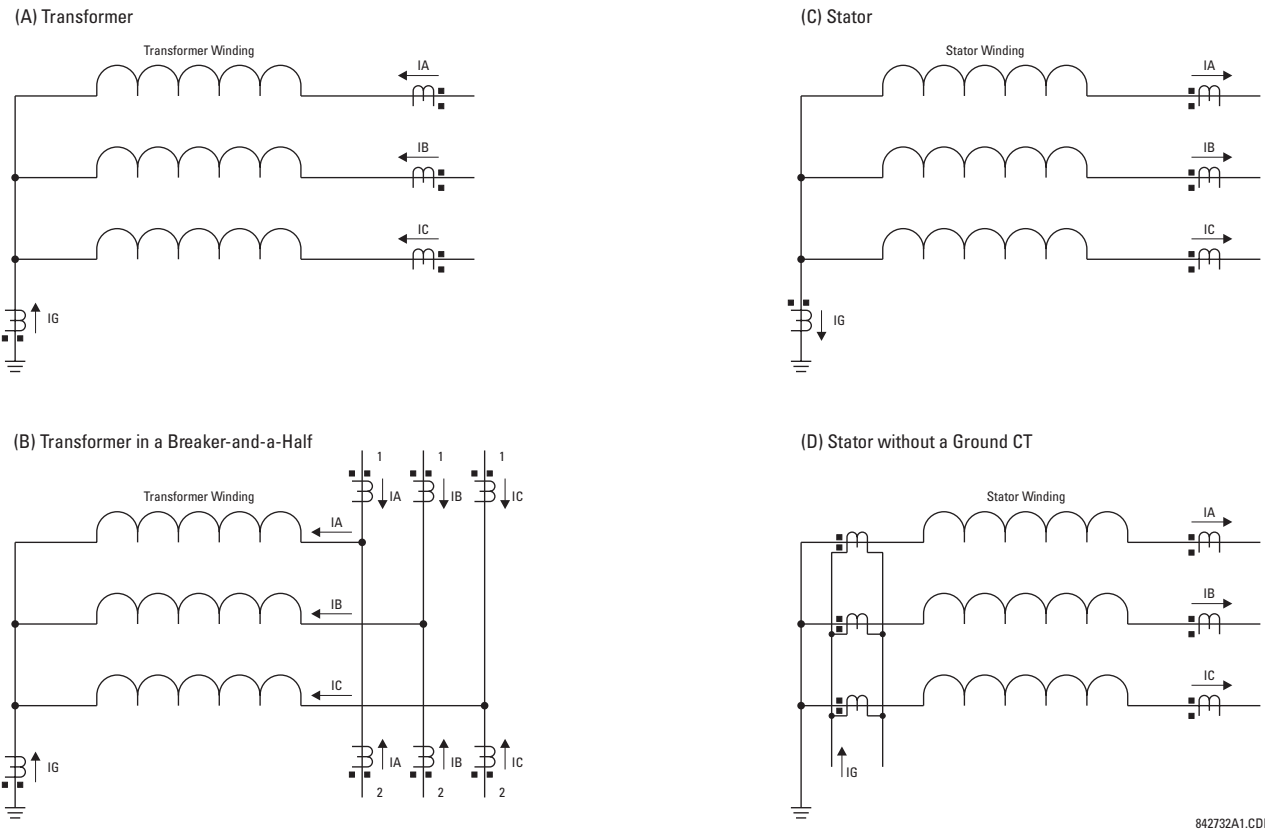

842732A1.CDR

Figure 5-60: TYPICAL APPLICATIONS OF RGF PROTECTION

The relay incorporates low-impedance RGF protection. The low-impedance form of the RGF faces potential stability problems. An external phase-to-phase fault is an ultimate case. Ideally, there is neither ground (IG) nor neutral ($I_N = I_A + I_B + I_C$) current present. If one or more of the phase CTs saturate, a spurious neutral current is seen by the relay. This is similar to a single infeed situation and may be mistaken for an internal fault. Similar difficulties occur in a breaker-and-a-half application of the RGF, where any through fault with a weak infeed from the winding itself may cause problems.

The UR uses a novel definition of the restraining signal to cope with the above stability problems while providing for fast and sensitive protection. Even with the improved definition of the restraining signal, the breaker-and-a-half application of the RGF must be approached with care, and is not recommended unless the settings are carefully selected to avoid maloperation due to CT saturation.

The differential current is produced as an unbalance current between the ground current of the neutral CT (IG) and the neutral current derived from the phase CTs ($I_N = I_A + I_B + I_C$):

$$I_{gd} = |I_G + I_N| = |I_G + I_A + I_B + I_C| \quad (\text{EQ 5.39})$$

The relay automatically matches the CT ratios between the phase and ground CTs by re-scaling the ground CT to the phase CT level. The restraining signal ensures stability of protection during CT saturation conditions and is produced as a maximum value between three components related to zero, negative, and positive-sequence currents of the three phase CTs as follows:

$$I_{rest} = \max(I_{R0}, I_{R1}, I_{R2}) \quad (\text{EQ 5.40})$$

The zero-sequence component of the restraining signal (I_{R0}) is meant to provide maximum restraint during external ground faults, and therefore is calculated as a vectorial difference of the ground and neutral currents:

$$IR0 = |IG - IN| = |IG - (IA + IB + IC)| \tag{EQ 5.41}$$

The equation above brings an advantage of generating the restraining signal of twice the external ground fault current, while reducing the restraint below the internal ground fault current. The negative-sequence component of the restraining signal (IR2) is meant to provide maximum restraint during external phase-to-phase faults and is calculated as follows:

$$IR2 = |I_{-2}| \text{ or } IR2 = 3 \times |I_{-2}| \tag{EQ 5.42}$$

The multiplier of 1 is used by the relay for first two cycles following complete de-energization of the winding (all three phase currents below 5% of nominal for at least five cycles). The multiplier of 3 is used during normal operation; that is, two cycles after the winding has been energized. The lower multiplier is used to ensure better sensitivity when energizing a faulty winding.

The positive-sequence component of the restraining signal (IR1) is meant to provide restraint during symmetrical conditions, either symmetrical faults or load, and is calculated according to the following algorithm:

- 1 If $|I_{-1}| > 1.5$ pu of phase CT, then
- 2 If $|I_{-1}| > |I_{-0}|$, then $IR1 = 3 \times (|I_{-1}| - |I_{-0}|)$
- 3 else $IR1 = 0$
- 4 else $IR1 = |I_{-1}|/8$

Under load-level currents (below 150% of nominal), the positive-sequence restraint is set to 1/8th of the positive-sequence current (Line 4). This is to ensure maximum sensitivity during low-current faults under full load conditions. Under fault-level currents (above 150% of nominal), the positive-sequence restraint is removed if the zero-sequence component is greater than the positive-sequence (Line 3), or set at the net difference of the two (Line 2).

The raw restraining signal (Irest) is further post-filtered for better performance during external faults with heavy CT saturation and for better switch-off transient control:

$$Igr(k) = \max(Irest(k), \alpha \times Igr(k - 1)) \tag{EQ 5.43}$$

where k represents a present sample, $k - 1$ represents the previous sample, and α is a factory constant ($\alpha < 1$). The equation above introduces a decaying memory to the restraining signal. Should the raw restraining signal (Irest) disappear or drop significantly, such as when an external fault gets cleared or a CT saturates heavily, the actual restraining signal (Igr(k)) will not reduce instantly but will keep decaying decreasing its value by 50% each 15.5 power system cycles.

Having the differential and restraining signals developed, the element applies a single slope differential characteristic with a minimum pickup as shown in the Restricted Ground Fault Scheme Logic diagram.

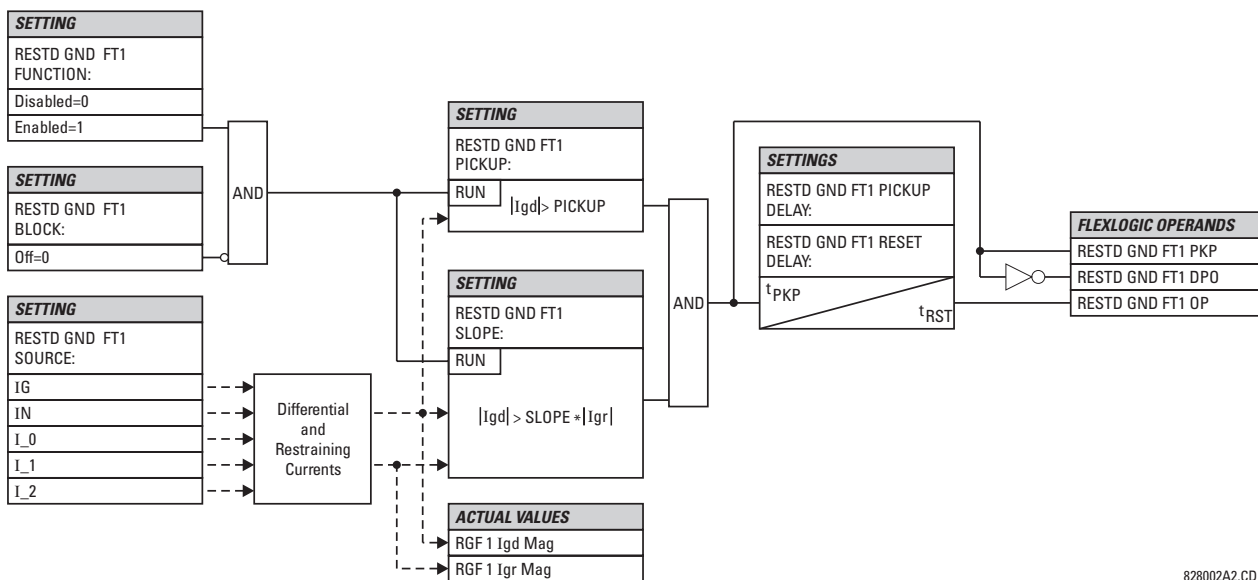

Figure 5-61: RESTRICTED GROUND FAULT SCHEME LOGIC

828002A2.CDR

The following examples explain how the restraining signal is created for maximum sensitivity and security. These examples clarify the operating principle and provide guidance for testing of the element.

EXAMPLE 1: EXTERNAL SINGLE-LINE-TO-GROUND FAULT

Given the following inputs: $I_A = 1 \text{ pu } \angle 0^\circ$, $I_B = 0$, $I_C = 0$, and $I_G = 1 \text{ pu } \angle 180^\circ$

The relay calculates the following values:

$$I_{gd} = 0, I_{R0} = \text{abs}\left(3 \times \frac{1}{3} - (-1)\right) = 2 \text{ pu}, I_{R2} = 3 \times \frac{1}{3} = 1 \text{ pu}, I_{R1} = \frac{1/3}{8} = 0.042 \text{ pu}, \text{ and } I_{gr} = 2 \text{ pu}$$

The restraining signal is twice the fault current. This gives extra margin should the phase or neutral CT saturate.

EXAMPLE 2: EXTERNAL HIGH-CURRENT SLG FAULT

Given the following inputs: $I_A = 10 \text{ pu } \angle 0^\circ$, $I_B = 0$, $I_C = 0$, and $I_G = 10 \text{ pu } \angle -180^\circ$

The relay calculates the following values:

$$I_{gd} = 0, I_{R0} = \text{abs}\left(3 \times \frac{1}{3} - (-10)\right) = 20 \text{ pu}, I_{R2} = 3 \times \frac{10}{3} = 10 \text{ pu}, I_{R1} = 3 \times \left(\frac{10}{3} - \frac{10}{3}\right) = 0, \text{ and } I_{gr} = 20 \text{ pu.}$$

EXAMPLE 3: EXTERNAL HIGH-CURRENT THREE-PHASE SYMMETRICAL FAULT

Given the following inputs: $I_A = 10 \text{ pu } \angle 0^\circ$, $I_B = 10 \text{ pu } \angle -120^\circ$, $I_C = 10 \text{ pu } \angle 120^\circ$, and $I_G = 0 \text{ pu}$

The relay calculates the following values:

$$I_{gd} = 0, I_{R0} = \text{abs}(3 \times 0 - (0)) = 0 \text{ pu}, I_{R2} = 3 \times 0 = 0 \text{ pu}, I_{R1} = 3 \times \left(\frac{10}{3} - 0\right) = 10 \text{ pu}, \text{ and } I_{gr} = 10 \text{ pu.}$$

EXAMPLE 4: INTERNAL LOW-CURRENT SINGLE-LINE-TO-GROUND FAULT UNDER FULL LOAD

Given the following inputs: $I_A = 1.10 \text{ pu } \angle 0^\circ$, $I_B = 1.0 \text{ pu } \angle -120^\circ$, $I_C = 1.0 \text{ pu } \angle 120^\circ$, and $I_G = 0.05 \text{ pu } \angle 0^\circ$

The relay calculates the following values:

$$I_{_0} = 0.033 \text{ pu } \angle 0^\circ, I_{_2} = 0.033 \text{ pu } \angle 0^\circ, \text{ and } I_{_1} = 1.033 \text{ pu } \angle 0^\circ$$

$$I_{gd} = \text{abs}(3 \times 0.0333 + 0.05) = 0.15 \text{ pu}, I_{R0} = \text{abs}(3 \times 0.033 - (0.05)) = 0.05 \text{ pu}, I_{R2} = 3 \times 0.033 = 0.10 \text{ pu}, I_{R1} = 1.033 / 8 = 0.1292 \text{ pu}, \text{ and } I_{gr} = 0.1292 \text{ pu}$$

Despite very low fault current level the differential current is above 100% of the restraining current.

EXAMPLE 5: INTERNAL LOW-CURRENT, HIGH-LOAD SINGLE-LINE-TO-GROUND FAULT WITH NO FEED FROM THE GROUND

Given the following inputs: $I_A = 1.10 \text{ pu } \angle 0^\circ$, $I_B = 1.0 \text{ pu } \angle -120^\circ$, $I_C = 1.0 \text{ pu } \angle 120^\circ$, and $I_G = 0.0 \text{ pu } \angle 0^\circ$

The relay calculates the following values:

$$I_{_0} = 0.033 \text{ pu } \angle 0^\circ, I_{_2} = 0.033 \text{ pu } \angle 0^\circ, \text{ and } I_{_1} = 1.033 \text{ pu } \angle 0^\circ$$

$$I_{gd} = \text{abs}(3 \times 0.0333 + 0.0) = 0.10 \text{ pu}, I_{R0} = \text{abs}(3 \times 0.033 - (0.0)) = 0.10 \text{ pu}, I_{R2} = 3 \times 0.033 = 0.10 \text{ pu}, I_{R1} = 1.033 / 8 = 0.1292 \text{ pu}, \text{ and } I_{gr} = 0.1292 \text{ pu}$$

Despite very low fault current level the differential current is above 75% of the restraining current.

EXAMPLE 6: INTERNAL HIGH-CURRENT SINGLE-LINE-TO-GROUND FAULT WITH NO FEED FROM THE GROUND

Given the following inputs: $I_A = 10 \text{ pu } \angle 0^\circ$, $I_B = 0 \text{ pu}$, $I_C = 0 \text{ pu}$, and $I_G = 0 \text{ pu}$

The relay calculates the following values:

$$I_{_0} = 3.3 \text{ pu } \angle 0^\circ, I_{_2} = 3.3 \text{ pu } \angle 0^\circ, \text{ and } I_{_1} = 3.3 \text{ pu } \angle 0^\circ$$

$$I_{gd} = \text{abs}(3 \times 3.3 + 0.0) = 10 \text{ pu}, I_{R0} = \text{abs}(3 \times 3.3 - (0.0)) = 10 \text{ pu}, I_{R2} = 3 \times 3.3 = 10 \text{ pu}, I_{R1} = 3 \times (3.33 - 3.33) = 0 \text{ pu}, \text{ and } I_{gr} = 10 \text{ pu}$$

The differential current is 100% of the restraining current.

5.5.7 VOLTAGE ELEMENTS

a) MAIN MENU

PATH: SETTINGS ↓ GROUPED ELEMENTS ⇒ SETTING GROUP 1(6) ⇒ ↓ VOLTAGE ELEMENTS

<input type="checkbox"/> VOLTAGE ELEMENTS <input type="checkbox"/>	◀▶	<input type="checkbox"/> PHASE <input type="checkbox"/> UNDERVOLTAGE1	See page 5-123.
MESSAGE	▲▼	<input type="checkbox"/> PHASE <input type="checkbox"/> UNDERVOLTAGE2	See page 5-123.
MESSAGE	▲▼	<input type="checkbox"/> PHASE <input type="checkbox"/> OVERVOLTAGE1	See page 5-124.
MESSAGE	▲▼	<input type="checkbox"/> NEUTRAL OV1 <input type="checkbox"/>	See page 5-125.
MESSAGE	▲▼	<input type="checkbox"/> AUXILIARY UV1 <input type="checkbox"/>	See page 5-126.
MESSAGE	▲▼	<input type="checkbox"/> AUXILIARY OV1 <input type="checkbox"/>	See page 5-127.
MESSAGE	▲▼	<input type="checkbox"/> VOLTS/HZ 1 <input type="checkbox"/>	See page 5-128.
MESSAGE	▲	<input type="checkbox"/> VOLTS/HZ 2 <input type="checkbox"/>	See page 5-128.

5

These protection elements can be used for a variety of applications such as:

Undervoltage Protection: For voltage sensitive loads, such as induction motors, a drop in voltage increases the drawn current which may cause dangerous overheating in the motor. The undervoltage protection feature can be used to either cause a trip or generate an alarm when the voltage drops below a specified voltage setting for a specified time delay.

Permissive Functions: The undervoltage feature may be used to block the functioning of external devices by operating an output relay when the voltage falls below the specified voltage setting. The undervoltage feature may also be used to block the functioning of other elements through the block feature of those elements.

Source Transfer Schemes: In the event of an undervoltage, a transfer signal may be generated to transfer a load from its normal source to a standby or emergency power source.

The undervoltage elements can be programmed to have a Definite Time delay characteristic. The Definite Time curve operates when the voltage drops below the pickup level for a specified period of time. The time delay is adjustable from 0 to 600.00 seconds in steps of 10 ms. The undervoltage elements can also be programmed to have an inverse time delay characteristic. The undervoltage delay setting defines the family of curves shown below.

$$T = \frac{D}{\left(1 - \frac{V}{V_{pickup}}\right)}$$

where: T = Operating Time
 D = Undervoltage Delay Setting
 (D = 0.00 operates instantaneously)
 V = Secondary Voltage applied to the relay
 V_{pickup} = Pickup Level



At 0% of pickup, the operating time equals the UNDERVOLTAGE DELAY setting.

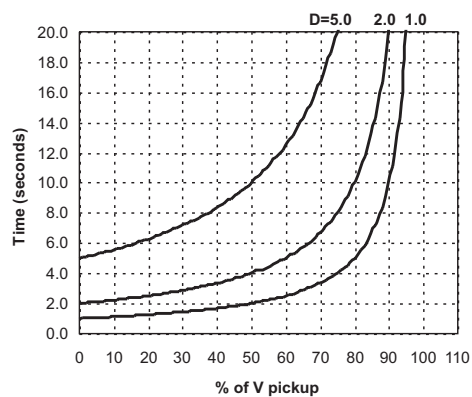

Figure 5-62: INVERSE TIME UNDERVOLTAGE CURVES

b) PHASE UNDERVOLTAGE (ANSI 27P)

PATH: SETTINGS ⇨ GROUPED ELEMENTS ⇨ SETTING GROUP 1(6) ⇨ VOLTAGE ELEMENTS ⇨ PHASE UNDERVOLTAGE1(2)

<ul style="list-style-type: none"> ■ PHASE ■ UNDERVOLTAGE1 	<div style="border: 1px solid black; padding: 2px;"> PHASE UV1 FUNCTION: Disabled </div>	Range: Disabled, Enabled
MESSAGE	<div style="border: 1px solid black; padding: 2px;"> PHASE UV1 SIGNAL SOURCE: SRC 1 </div>	Range: SRC 1, SRC 2, SRC 3, SRC 4
MESSAGE	<div style="border: 1px solid black; padding: 2px;"> PHASE UV1 MODE: Phase to Ground </div>	Range: Phase to Ground, Phase to Phase
MESSAGE	<div style="border: 1px solid black; padding: 2px;"> PHASE UV1 PICKUP: 1.000 pu </div>	Range: 0.000 to 3.000 pu in steps of 0.001
MESSAGE	<div style="border: 1px solid black; padding: 2px;"> PHASE UV1 CURVE: Definite Time </div>	Range: Definite Time, Inverse Time
MESSAGE	<div style="border: 1px solid black; padding: 2px;"> PHASE UV1 DELAY: 1.00 s </div>	Range: 0.00 to 600.00 s in steps of 0.01
MESSAGE	<div style="border: 1px solid black; padding: 2px;"> PHASE UV1 MINIMUM VOLTAGE: 0.100 pu </div>	Range: 0.000 to 3.000 pu in steps of 0.001
MESSAGE	<div style="border: 1px solid black; padding: 2px;"> PHASE UV1 BLOCK: Off </div>	Range: FlexLogic™ operand
MESSAGE	<div style="border: 1px solid black; padding: 2px;"> PHASE UV1 TARGET: Self-reset </div>	Range: Self-reset, Latched, Disabled
MESSAGE	<div style="border: 1px solid black; padding: 2px;"> PHASE UV1 EVENTS: Disabled </div>	Range: Disabled, Enabled

This element may be used to give a desired time-delay operating characteristic versus the applied fundamental voltage (phase-to-ground or phase-to-phase for Wye VT connection, or phase-to-phase for Delta VT connection) or as a Definite Time element. The element resets instantaneously if the applied voltage exceeds the dropout voltage. The delay setting selects the minimum operating time of the phase undervoltage. The minimum voltage setting selects the operating voltage below which the element is blocked (a setting of "0" will allow a dead source to be considered a fault condition).

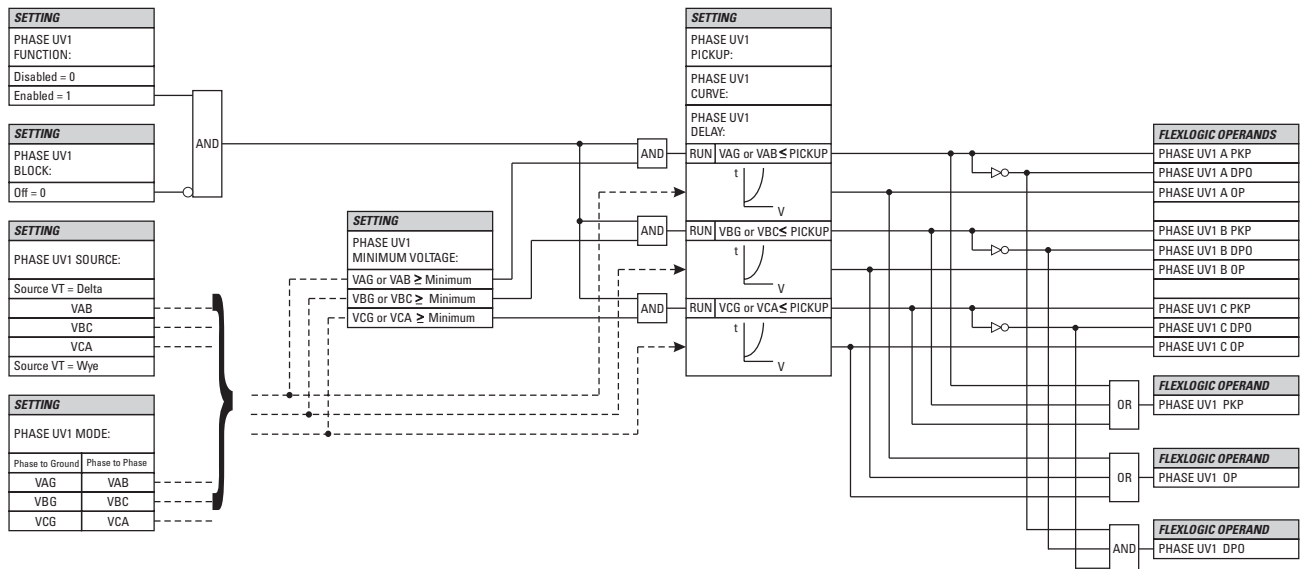

Figure 5–63: PHASE UNDERVOLTAGE1 SCHEME LOGIC

c) PHASE OVERVOLTAGE (ANSI 59P)

PATH: SETTINGS ⇄ GROUPED ELEMENTS ⇄ SETTING GROUP 1(6) ⇄ VOLTAGE ELEMENTS ⇄ PHASE OVERVOLTAGE1

<ul style="list-style-type: none"> ■ PHASE ■ OVERVOLTAGE1 	<div style="text-align: center;">◀▶</div>	PHASE OV1 FUNCTION: Disabled	Range: Disabled, Enabled
MESSAGE	<div style="text-align: center;">▲▼</div>	PHASE OV1 SIGNAL SOURCE: SRC 1	Range: SRC 1, SRC 2, SRC 3, SRC 4
MESSAGE	<div style="text-align: center;">▲▼</div>	PHASE OV1 PICKUP PICKUP: 1.000 pu	Range: 0.000 to 3.000 pu in steps of 0.001
MESSAGE	<div style="text-align: center;">▲▼</div>	PHASE OV1 PICKUP DELAY DELAY: 1.00 s	Range: 0.00 to 600.00 s in steps of 0.01
MESSAGE	<div style="text-align: center;">▲▼</div>	PHASE OV1 RESET DELAY DELAY: 1.00 s	Range: 0.00 to 600.00 s in steps of 0.01
MESSAGE	<div style="text-align: center;">▲▼</div>	PHASE OV1 BLOCK: Off	Range: FlexLogic™ Operand
MESSAGE	<div style="text-align: center;">▲▼</div>	PHASE OV1 TARGET: Self-reset	Range: Self-reset, Latched, Disabled
MESSAGE	<div style="text-align: center;">▲</div>	PHASE OV1 EVENTS: Disabled	Range: Disabled, Enabled

5

The phase overvoltage element may be used as an instantaneous element with no intentional time delay or as a Definite Time element. The input voltage is the phase-to-phase voltage, either measured directly from Delta-connected VTs or as calculated from phase-to-ground (Wye) connected VTs. The specific voltages to be used for each phase are shown below.

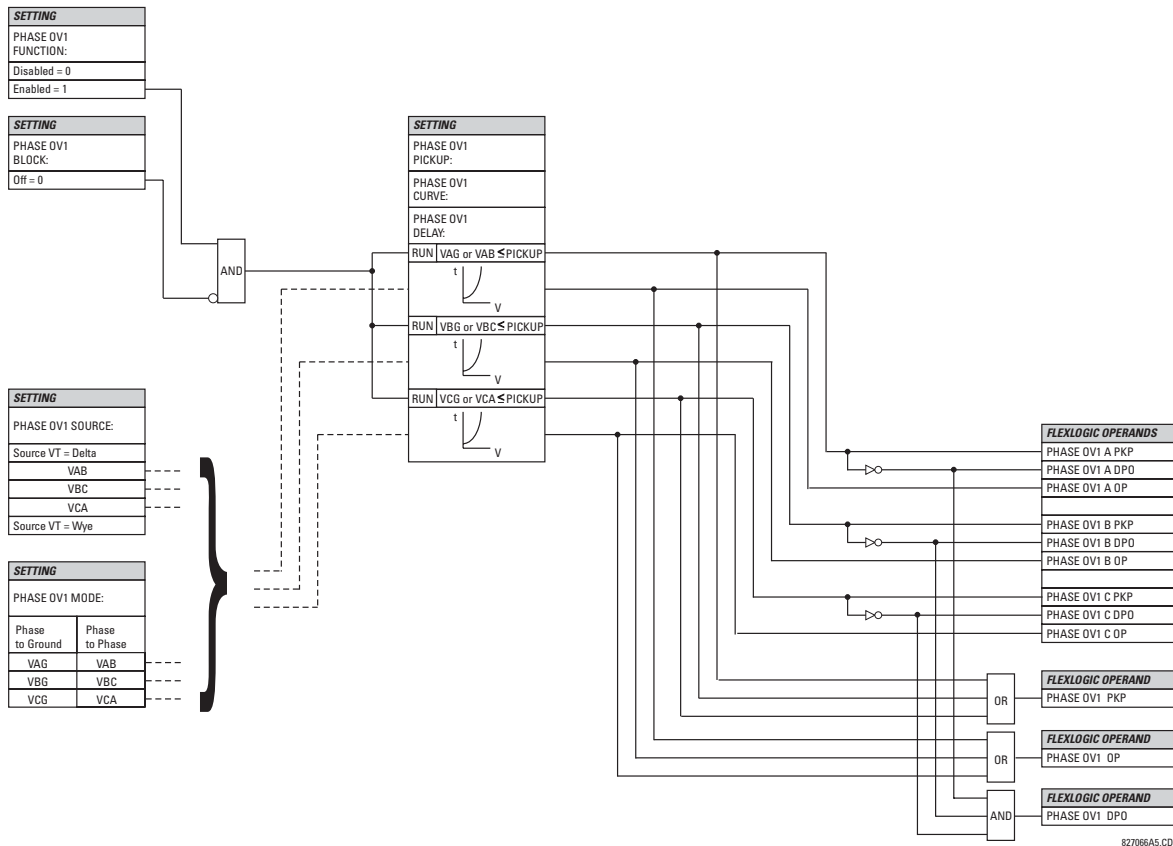

Figure 5-64: PHASE OVERVOLTAGE SCHEME LOGIC

d) NEUTRAL OVERVOLTAGE (ANSI 59N)

PATH: SETTINGS ⇒ GROUPED ELEMENTS ⇒ SETTING GROUP 1(6) ⇒ VOLTAGE ELEMENTS ⇒ NEUTRAL OV1

■ NEUTRAL OV1	◀▶	NEUTRAL OV1 FUNCTION: Disabled	Range: Disabled, Enabled
MESSAGE	▲▼	NEUTRAL OV1 SIGNAL SOURCE: SRC 1	Range: SRC 1, SRC 2, SRC 3, SRC 4
MESSAGE	▲▼	NEUTRAL OV1 PICKUP: 0.300 pu	Range: 0.000 to 1.250 pu in steps of 0.001
MESSAGE	▲▼	NEUTRAL OV1 PICKUP: DELAY: 1.00 s	Range: 0.00 to 600.00 s in steps of 0.01
MESSAGE	▲▼	NEUTRAL OV1 RESET: DELAY: 1.00 s	Range: 0.00 to 600.00 s in steps of 0.01
MESSAGE	▲▼	NEUTRAL OV1 BLOCK: Off	Range: FlexLogic™ operand
MESSAGE	▲▼	NEUTRAL OV1 TARGET: Self-reset	Range: Self-reset, Latched, Disabled
MESSAGE	▲	NEUTRAL OV1 EVENTS: Disabled	Range: Disabled, Enabled

The Neutral Overvoltage element can be used to detect asymmetrical system voltage condition due to a ground fault or to the loss of one or two phases of the source. The element responds to the system neutral voltage (3V_0), calculated from the phase voltages. The nominal secondary voltage of the phase voltage channels entered under **SETTINGS** ⇒ **SYSTEM SETUP** ⇒ **AC INPUTS** ⇒ **VOLTAGE BANK** ⇒ **PHASE VT SECONDARY** is the p.u. base used when setting the pickup level.

VT errors and normal voltage unbalance must be considered when setting this element. This function requires the VTs to be Wye connected.

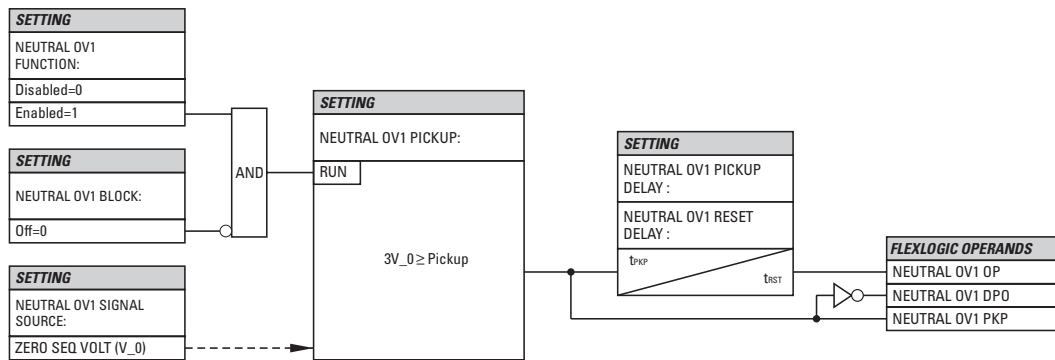

827848A1.CDR

Figure 5–65: NEUTRAL OVERVOLTAGE1 SCHEME LOGIC

e) AUXILIARY UNDERVOLTAGE (ANSI 27X)

PATH: SETTINGS ⇌ GROUPED ELEMENTS ⇌ SETTING GROUP 1(6) ⇌ VOLTAGE ELEMENTS ⇌ AUXILIARY UV1

<input type="checkbox"/> AUXILIARY UV1		AUX UV1 FUNCTION: Disabled	Range: Disabled, Enabled
MESSAGE		AUX UV1 SIGNAL SOURCE: SRC 1	Range: SRC 1, SRC 2, SRC 3, SRC 4
MESSAGE		AUX UV1 PICKUP: 0.700 pu	Range: 0.000 to 3.000 pu in steps of 0.001
MESSAGE		AUX UV1 CURVE: Definite Time	Range: Definite Time, Inverse Time
MESSAGE		AUX UV1 DELAY: 1.00 s	Range: 0.00 to 600.00 s in steps of 0.01
MESSAGE		AUX UV1 MINIMUM: VOLTAGE: 0.100 pu	Range: 0.000 to 3.000 pu in steps of 0.001
MESSAGE		AUX UV1 BLOCK: Off	Range: FlexLogic™ operand
MESSAGE		AUX UV1 TARGET: Self-reset	Range: Self-reset, Latched, Disabled
MESSAGE		AUX UV1 EVENTS: Disabled	Range: Disabled, Enabled

5

This element is intended for monitoring undervoltage conditions of the auxiliary voltage. The **AUX UV1 PICKUP** selects the voltage level at which the time undervoltage element starts timing. The nominal secondary voltage of the auxiliary voltage channel entered under **SETTINGS** ⇌ **SYSTEM SETUP** ⇌ **AC INPUTS** ⇌ **VOLTAGE BANK X5** ⇌ **AUXILIARY VT X5 SECONDARY** is the p.u. base used when setting the pickup level.

The **AUX UV1 DELAY** setting selects the minimum operating time of the auxiliary undervoltage element. Both **AUX UV1 PICKUP** and **AUX UV1 DELAY** settings establish the operating curve of the undervoltage element. The auxiliary undervoltage element can be programmed to use either Definite Time Delay or Inverse Time Delay characteristics. The operating characteristics and equations for both Definite and Inverse Time Delay are as for the Phase Undervoltage element.

The element resets instantaneously. The minimum voltage setting selects the operating voltage below which the element is blocked.

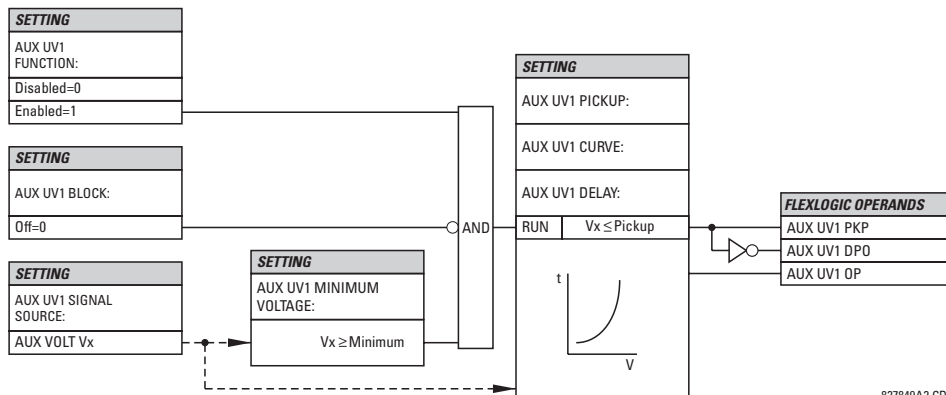

Figure 5-66: AUXILIARY UNDERVOLTAGE SCHEME LOGIC

f) AUXILIARY OVERVOLTAGE (ANSI 59X)

PATH: SETTINGS ⇒ GROUPED ELEMENTS ⇒ SETTING GROUP 1(6) ⇒ VOLTAGE ELEMENTS ⇒ AUXILIARY OV1

<div style="background-color: #f0f0f0; padding: 2px;"> ■ AUXILIARY OV1 </div>		AUX OV1 FUNCTION: Disabled	Range: Disabled, Enabled
MESSAGE		AUX OV1 SIGNAL SOURCE: SRC 1	Range: SRC 1, SRC 2, SRC 3, SRC 4
MESSAGE		AUX OV1 PICKUP: 0.300 pu	Range: 0.000 to 3.000 pu in steps of 0.001
MESSAGE		AUX OV1 PICKUP DELAY: 1.00 s	Range: 0.00 to 600.00 s in steps of 0.01
MESSAGE		AUX OV1 RESET DELAY: 1.00 s	Range: 0.00 to 600.00 s in steps of 0.01
MESSAGE		AUX OV1 BLOCK: Off	Range: FlexLogic™ operand
MESSAGE		AUX OV1 TARGET: Self-reset	Range: Self-reset, Latched, Disabled
MESSAGE		AUX OV1 EVENTS: Disabled	Range: Disabled, Enabled

This element is intended for monitoring overvoltage conditions of the auxiliary voltage. A typical application for this element is monitoring the zero-sequence voltage (3V₀) supplied from an open-corner-delta VT connection. The nominal secondary voltage of the auxiliary voltage channel entered under SYSTEM SETUP ⇒ AC INPUTS ⇒ VOLTAGE BANK X5 ⇒ AUXILIARY VT X5 SECONDARY is the p.u. base used when setting the pickup level.

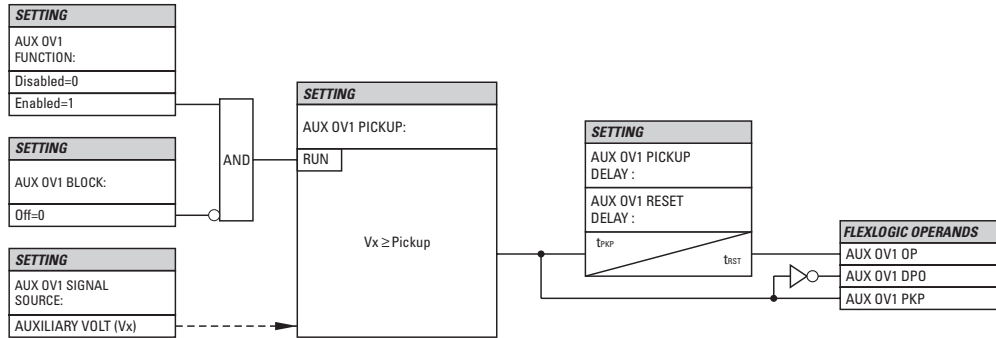
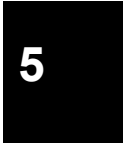

827836A2.CDR

Figure 5–67: AUXILIARY OVERVOLTAGE SCHEME LOGIC

g) VOLTS PER HERTZ (ANSI 24)

PATH: SETTINGS ⇒ GROUPED ELEMENTS ⇒ SETTING GROUP 1(6) ⇒ VOLTAGE ELEMENTS ⇒ VOLTS/HZ 1(2)

<input type="checkbox"/> VOLTS/HZ 1		VOLTS/HZ 1 FUNCTION:	Range: Disabled, Enabled
	MESSAGE	Disabled	
		VOLTS/HZ 1 SOURCE:	Range: SRC 1, SRC 2, SRC 3, SRC 4
	MESSAGE	SRC 1	
		VOLTS/HZ 1 PICKUP:	Range: 0.80 to 4.00 pu in steps of 0.01
	MESSAGE	1.00 pu	
		VOLTS/HZ 1 CURVE:	Range: Definite Time, Inverse A, Inverse B, Inverse C, FlexCurve A, FlexCurve B, FlexCurve C, FlexCurve D
	MESSAGE	Definite Time	
		VOLTS/HZ 1 TD	Range: 0.05 to 600.00 in steps of 0.01
	MESSAGE	MULTIPLIER: 1.00	
		VOLTS/HZ 1	Range: 0.0 to 1000.0 s in steps of 0.1
	MESSAGE	T-RESET: 1.0 s	
		VOLTS/HZ 1 BLOCK:	Range: FlexLogic™ operand
	MESSAGE	Off	
		VOLTS/HZ 1 TARGET:	Range: Self-reset, Latched, Disabled
	MESSAGE	Self-reset	
		VOLTS/HZ 1 EVENTS:	Range: Disabled, Enabled
	MESSAGE	Disabled	

5

The per-unit V/Hz value is calculated using the maximum of the three-phase voltage inputs or the auxiliary voltage channel Vx input, if the Source is not configured with phase voltages. To use the V/Hz element with auxiliary voltage, set **SYSTEM SETUP** ⇒ **SIGNAL SOURCES** ⇒ **SOURCE 1(6)** ⇒ **SOURCE 1(6) PHASE VT** to “None” and **SOURCE 1(6) AUX VT** to the corresponding voltage input bank. If there is no voltage on the relay terminals in either case, the per-unit V/Hz value is automatically set to “0”. The per unit value is established as per voltage and nominal frequency power system settings as follows:

1. If the phase voltage inputs defined in the source menu are used for V/Hz operation, then “1 pu” is the selected **SYSTEM SETUP** ⇒ **AC INPUTS** ⇒ **VOLTAGE BANK N** ⇒ **PHASE VT N SECONDARY** setting, divided by the divided by the **SYSTEM SETUP** ⇒ **POWER SYSTEM** ⇒ **NOMINAL FREQUENCY** setting.
2. When the auxiliary voltage Vx is used (regarding the condition for “None” phase voltage setting mentioned above), then the 1 pu value is the **SYSTEM SETUP** ⇒ **AC INPUTS** ⇒ **VOLTAGE BANK N** ⇒ **AUXILIARY VT N SECONDARY** setting divided by the **SYSTEM SETUP** ⇒ **POWER SYSTEM** ⇒ **NOMINAL FREQUENCY** setting.
3. If V/Hz source is configured with both phase and auxiliary voltages, the maximum phase among the three voltage channels at any given point in time is the input voltage signal for element operation, and therefore the per-unit value will be calculated as described in Step 1 above. If the measured voltage of all three phase voltages is 0, than the per-unit value becomes automatically 0 regardless of the presence of auxiliary voltage.

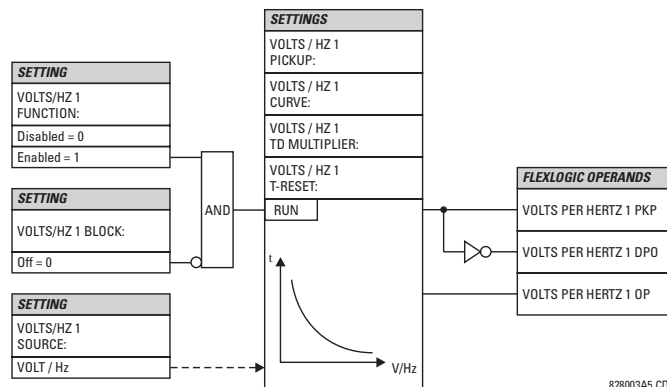

Figure 5-68: VOLTS PER HERTZ SCHEME LOGIC

The element has a linear reset characteristic. The reset time can be programmed to match the cooling characteristics of the protected equipment. The element will fully reset from the trip threshold in **VOLTS/HZ T-RESET** seconds. The V/Hz element may be used as an instantaneous element with no intentional time delay or as a Definite or Inverse timed element.

The characteristics of the inverse curves are shown below.

- **DEFINITE TIME:** $T(\text{sec.}) = \text{TD Multiplier}$. For example, setting the TD Multiplier set to 20 means a time delay of 20 seconds to operate, when above the Volts/Hz pickup setting. Instantaneous operation can be obtained the same way by setting the TD Multiplier to "0".

- **INVERSE CURVE A:**

The curve for the Volts/Hertz Inverse Curve A shape is derived from the formula:

$$T = \frac{\text{TDM}}{\left[\left(\frac{V}{F}\right)/\text{Pickup}\right]^2 - 1} \text{ when } \frac{V}{F} > \text{Pickup} \quad (\text{EQ 5.44})$$

where: T = Operating Time
 TDM = Time Delay Multiplier (delay in sec.)
 V = fundamental RMS value of voltage (pu)
 F = frequency of voltage signal (pu)
 Pickup = volts-per-hertz pickup setpoint (pu)

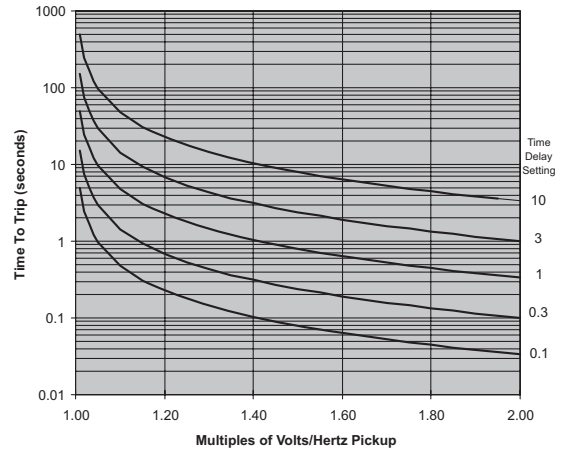

- **INVERSE CURVE B:**

The curve for the Volts/Hertz Inverse Curve B shape is derived from the formula:

$$T = \frac{\text{TDM}}{\left[\left(\frac{V}{F}\right)/\text{Pickup}\right] - 1} \text{ when } \frac{V}{F} > \text{Pickup} \quad (\text{EQ 5.45})$$

where: T = Operating Time
 TDM = Time Delay Multiplier (delay in sec.)
 V = fundamental RMS value of voltage (pu)
 F = frequency of voltage signal (pu)
 Pickup = volts-per-hertz pickup setpoint (pu)

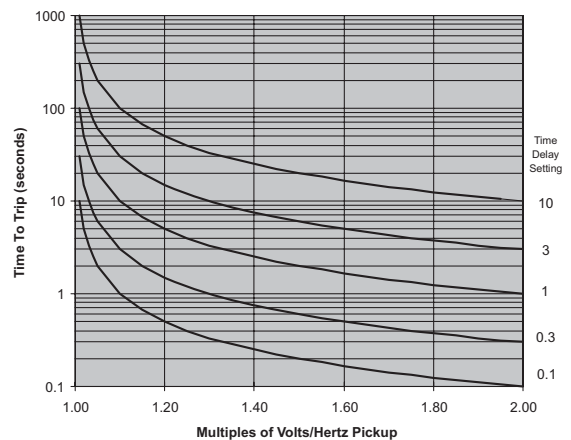

- **INVERSE CURVE C:**

The curve for the Volts/Hertz Inverse Curve C shape is derived from the formula:

$$T = \frac{\text{TDM}}{\left[\left(\frac{V}{F}\right)/\text{Pickup}\right]^{0.5} - 1} \text{ when } \frac{V}{F} > \text{Pickup} \quad (\text{EQ 5.46})$$

where: T = Operating Time
 TDM = Time Delay Multiplier (delay in sec.)
 V = fundamental RMS value of voltage (pu)
 F = frequency of voltage signal (pu)
 Pickup = volts-per-hertz pickup setpoint (pu)

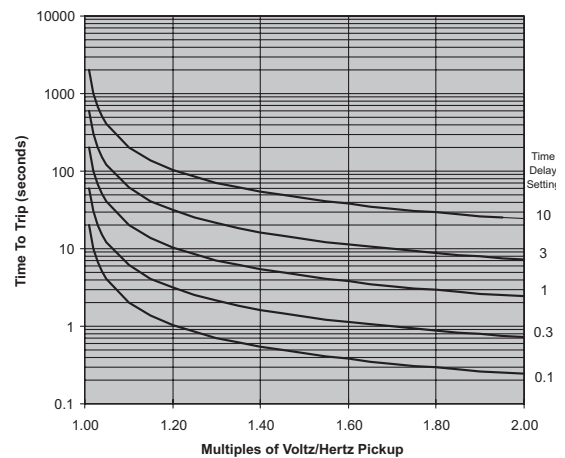

5.6.1 OVERVIEW

Control elements are generally used for control rather than protection. See the *Introduction to Elements* section at the beginning of this chapter for further information.

5.6.2 SETTING GROUPS

PATH: SETTINGS ⇌ CONTROL ELEMENTS ⇌ SETTINGS GROUPS

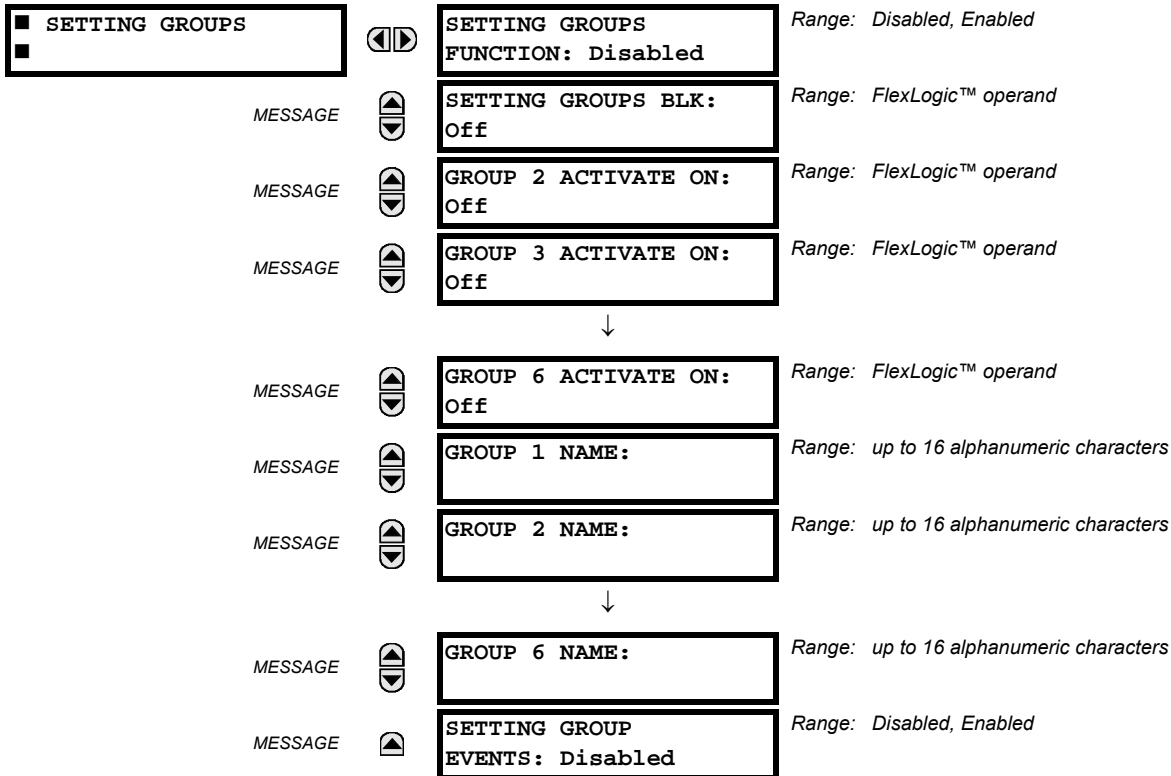

The Setting Groups menu controls the activation/deactivation of up to six possible groups of settings in the **GROUPED ELEMENTS** settings menu. The faceplate 'Settings In Use' LEDs indicate which active group (with a non-flashing energized LED) is in service.

The **SETTING GROUPS BLK** setting prevents the active setting group from changing when the FlexLogic™ parameter is set to "On". This can be useful in applications where it is undesirable to change the settings under certain conditions, such as the breaker being open.

Each **GROUP n ACTIVATE ON** setting selects a FlexLogic™ operand which, when set, will make the particular setting group active for use by any grouped element. A priority scheme ensures that only one group is active at a given time – the highest-numbered group which is activated by its **GROUP n ACTIVATE ON** parameter takes priority over the lower-numbered groups. There is no "activate on" setting for Group 1 (the default active group), because Group 1 automatically becomes active if no other group is active.

The **SETTING GROUP 1(6) NAME** settings allows to user to assign a name to each of the six settings groups. Once programmed, this name will appear on the second line of the **GROUPED ELEMENTS ⇌ SETTING GROUP 1(6)** menu display.

The relay can be set up via a FlexLogic™ equation to receive requests to activate or de-activate a particular non-default settings group. The following FlexLogic™ equation (see the figure below) illustrates requests via remote communications (e.g. VIRTUAL INPUT 1) or from a local contact input (e.g. H7a) to initiate the use of a particular settings group, and requests from several overcurrent pickup measuring elements to inhibit the use of the particular settings group. The assigned VIRTUAL OUTPUT 1 operand is used to control the "On" state of a particular settings group.

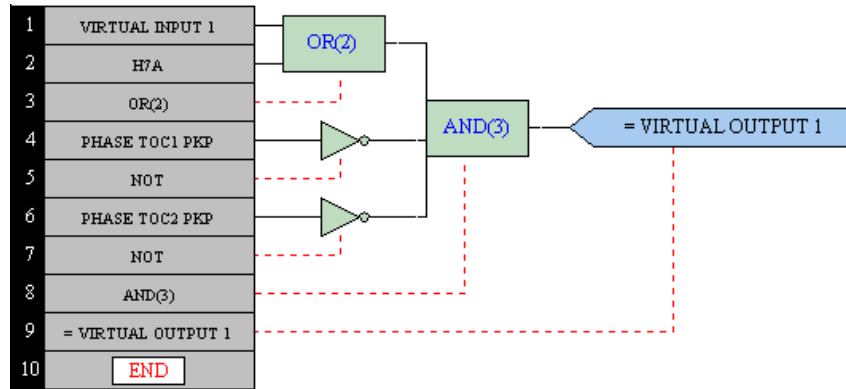

Figure 5-69: EXAMPLE FLEXLOGIC™ CONTROL OF A SETTINGS GROUP

5.6.3 SELECTOR SWITCH

PATH: SETTINGS ⇄ CONTROL ELEMENTS ⇄ SELECTOR SWITCH ⇄ SELECTOR SWITCH 1(2)

<div style="display: flex; align-items: center;"> <div style="width: 15px; height: 15px; background-color: black; margin-right: 5px;"></div> SELECTOR SWITCH 1 </div>	◀▶	SELECTOR 1 FUNCTION: Disabled	<i>Range: Disabled, Enabled</i>
MESSAGE	▲▼	SELECTOR 1 FULL RANGE: 7	<i>Range: 1 to 7 in steps of 1</i>
MESSAGE	▲▼	SELECTOR 1 TIME-OUT: 5.0 s	<i>Range: 3.0 to 60.0 s in steps of 0.1</i>
MESSAGE	▲▼	SELECTOR 1 STEP-UP: Off	<i>Range: FlexLogic™ operand</i>
MESSAGE	▲▼	SELECTOR 1 STEP-UP MODE: Time-out	<i>Range: Time-out, Acknowledge</i>
MESSAGE	▲▼	SELECTOR 1 ACK: Off	<i>Range: FlexLogic™ operand</i>
MESSAGE	▲▼	SELECTOR 1 3BIT A0: Off	<i>Range: FlexLogic™ operand</i>
MESSAGE	▲▼	SELECTOR 1 3BIT A1: Off	<i>Range: FlexLogic™ operand</i>
MESSAGE	▲▼	SELECTOR 1 3BIT A2: Off	<i>Range: FlexLogic™ operand</i>
MESSAGE	▲▼	SELECTOR 1 3BIT MODE: Time-out	<i>Range: Time-out, Acknowledge</i>
MESSAGE	▲▼	SELECTOR 1 3BIT ACK: Off	<i>Range: FlexLogic™ operand</i>
MESSAGE	▲▼	SELECTOR 1 POWER-UP MODE: Restore	<i>Range: Restore, Synchronize, Sync/Restore</i>
MESSAGE	▲▼	SELECTOR 1 TARGETS: Self-reset	<i>Range: Self-reset, Latched, Disabled</i>
MESSAGE	▲	SELECTOR 1 EVENTS: Disabled	<i>Range: Disabled, Enabled</i>

The Selector Switch element is intended to replace a mechanical selector switch. Typical applications include setting group control or control of multiple logic sub-circuits in user-programmable logic.

The element provides for two control inputs. The step-up control allows stepping through selector position one step at a time with each pulse of the control input, such as a user-programmable pushbutton. The 3-bit control input allows setting the selector to the position defined by a 3-bit word.

The element allows pre-selecting a new position without applying it. The pre-selected position gets applied either after time-out or upon acknowledgement via separate inputs (user setting). The selector position is stored in non-volatile memory. Upon power-up, either the previous position is restored or the relay synchronizes to the current 3-bit word (user setting). Basic alarm functionality alerts the user under abnormal conditions; e.g. the 3-bit control input being out of range.

- **SELECTOR 1 FULL RANGE:** This setting defines the upper position of the selector. When stepping up through available positions of the selector, the upper position wraps up to the lower position (Position 1). When using a direct 3-bit control word for programming the selector to a desired position, the change would take place only if the control word is within the range of 1 to the **SELECTOR FULL RANGE**. If the control word is outside the range, an alarm is established by setting the **SELECTOR ALARM FlexLogic™** operand for 3 seconds.
- **SELECTOR 1 TIME-OUT:** This setting defines the time-out period for the selector. This value is used by the relay in the following two ways. When the **SELECTOR STEP-UP MODE** is “Time-out”, the setting specifies the required period of inactivity of the control input after which the pre-selected position is automatically applied. When the **SELECTOR STEP-UP MODE** is “Acknowledge”, the setting specifies the period of time for the acknowledging input to appear. The timer is re-started by any activity of the control input. The acknowledging input must come before the **SELECTOR 1 TIME-OUT** timer expires; otherwise, the change will not take place and an alarm will be set.
- **SELECTOR 1 STEP-UP:** This setting specifies a control input for the selector switch. The switch is shifted to a new position at each rising edge of this signal. The position changes incrementally, wrapping up from the last (**SELECTOR 1 FULL RANGE**) to the first (Position 1). Consecutive pulses of this control operand must not occur faster than every 50 ms. After each rising edge of the assigned operand, the time-out timer is restarted and the **SELECTOR SWITCH 1: POS Z CHNG INITIATED** target message is displayed, where **Z** the pre-selected position. The message is displayed for the time specified by the **FLASH MESSAGE TIME** setting. The pre-selected position is applied after the selector times out (“Time-out” mode), or when the acknowledging signal appears before the element times out (“Acknowledge” mode). When the new position is applied, the relay displays the **SELECTOR SWITCH 1: POSITION Z IN USE** message. Typically, a user-programmable pushbutton is configured as the stepping up control input.
- **SELECTOR 1 STEP-UP MODE:** This setting defines the selector mode of operation. When set to “Time-out”, the selector will change its position after a pre-defined period of inactivity at the control input. The change is automatic and does not require any explicit confirmation of the intent to change the selector's position. When set to “Acknowledge”, the selector will change its position only after the intent is confirmed through a separate acknowledging signal. If the acknowledging signal does not appear within a pre-defined period of time, the selector does not accept the change and an alarm is established by setting the **SELECTOR STP ALARM** output FlexLogic™ operand for 3 seconds.
- **SELECTOR 1 ACK:** This setting specifies an acknowledging input for the stepping up control input. The pre-selected position is applied on the rising edge of the assigned operand. This setting is active only under “Acknowledge” mode of operation. The acknowledging signal must appear within the time defined by the **SELECTOR 1 TIME-OUT** setting after the last activity of the control input. A user-programmable pushbutton is typically configured as the acknowledging input.
- **SELECTOR 1 3BIT A0, A1, and A2:** These settings specify a 3-bit control input of the selector. The 3-bit control word pre-selects the position using the following encoding convention:

A2	A1	A0	POSITION
0	0	0	rest
0	0	1	1
0	1	0	2
0	1	1	3
1	0	0	4
1	0	1	5
1	1	0	6
1	1	1	7

The “rest” position (0, 0, 0) does not generate an action and is intended for situations when the device generating the 3-bit control word is having a problem. When **SELECTOR 1 3BIT MODE** is “Time-out”, the pre-selected position is applied in **SELECTOR 1 TIME-OUT** seconds after the last activity of the 3-bit input. When **SELECTOR 1 3BIT MODE** is “Acknowledge”, the pre-selected position is applied on the rising edge of the **SELECTOR 1 3BIT ACK** acknowledging input.

The stepping up control input (**SELECTOR 1 STEP-UP**) and the 3-bit control inputs (**SELECTOR 1 3BIT A0** through **A2**) lock-out mutually: once the stepping up sequence is initiated, the 3-bit control input is inactive; once the 3-bit control sequence is initiated, the stepping up input is inactive.

- **SELECTOR 1 3BIT MODE:** This setting defines the selector mode of operation. When set to “Time-out”, the selector changes its position after a pre-defined period of inactivity at the control input. The change is automatic and does not require explicit confirmation to change the selector position. When set to “Acknowledge”, the selector changes its position only after confirmation via a separate acknowledging signal. If the acknowledging signal does not appear within a pre-defined period of time, the selector rejects the change and an alarm established by invoking the **SELECTOR BIT ALARM FlexLogic™** operand for 3 seconds.
- **SELECTOR 1 3BIT ACK:** This setting specifies an acknowledging input for the 3-bit control input. The pre-selected position is applied on the rising edge of the assigned FlexLogic™ operand. This setting is active only under the “Acknowledge” mode of operation. The acknowledging signal must appear within the time defined by the **SELECTOR TIME-OUT** setting after the last activity of the 3-bit control inputs. Note that the stepping up control input and 3-bit control input have independent acknowledging signals (**SELECTOR 1 ACK** and **SELECTOR 1 3BIT ACK**, accordingly).
- **SELECTOR 1 POWER-UP MODE:** This setting specifies the element behavior on power up of the relay.

When set to “Restore”, the last position of the selector (stored in the non-volatile memory) is restored after powering up the relay. If the position restored from memory is out of range, position 0 (no output operand selected) is applied and an alarm is set (**SELECTOR 1 PWR ALARM**).

When set to “Synchronize” selector switch acts as follows. For two power cycles, the selector applies position 0 to the switch and activates **SELECTOR 1 PWR ALARM**. After two power cycles expire, the selector synchronizes to the position dictated by the 3-bit control input. This operation does not wait for time-out or the acknowledging input. When the synchronization attempt is unsuccessful (i.e., the 3-bit input is not available (0,0,0) or out of range) then the selector switch output is set to position 0 (no output operand selected) and an alarm is established (**SELECTOR 1 PWR ALARM**).

The operation of “Synch/Restore” mode is similar to the “Synchronize” mode. The only difference is that after an unsuccessful synchronization attempt, the switch will attempt to restore the position stored in the relay memory. The “Synch/Restore” mode is useful for applications where the selector switch is employed to change the setting group in redundant (two relay) protection schemes.

- **SELECTOR 1 EVENTS:** If enabled, the following events are logged:

EVENT NAME	DESCRIPTION
SELECTOR 1 POS Z	Selector 1 changed its position to Z.
SELECTOR 1 STP ALARM	The selector position pre-selected via the stepping up control input has not been confirmed before the time out.
SELECTOR 1 BIT ALARM	The selector position pre-selected via the 3-bit control input has not been confirmed before the time out.

The following figures illustrate the operation of the Selector Switch. In these diagrams, "T" represents a time-out setting.

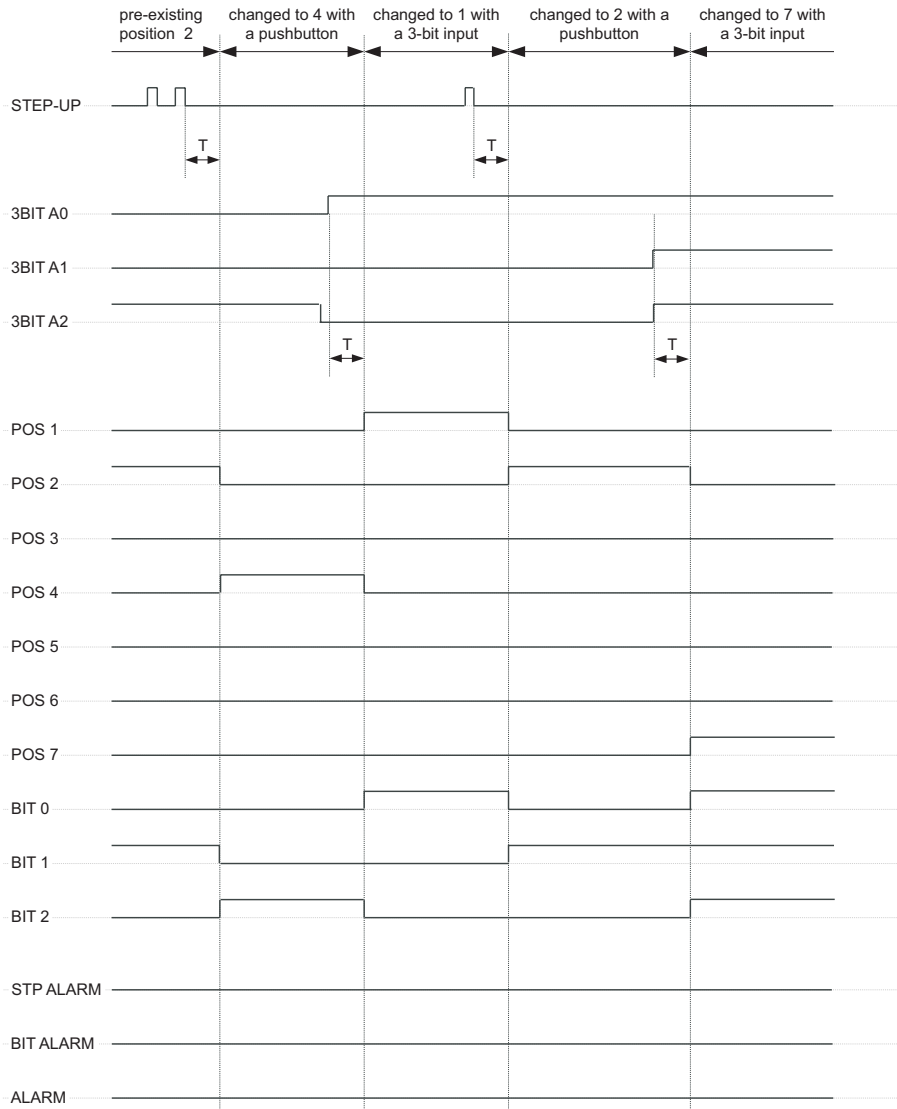

842737A1.CDR

Figure 5-70: TIME-OUT MODE

5

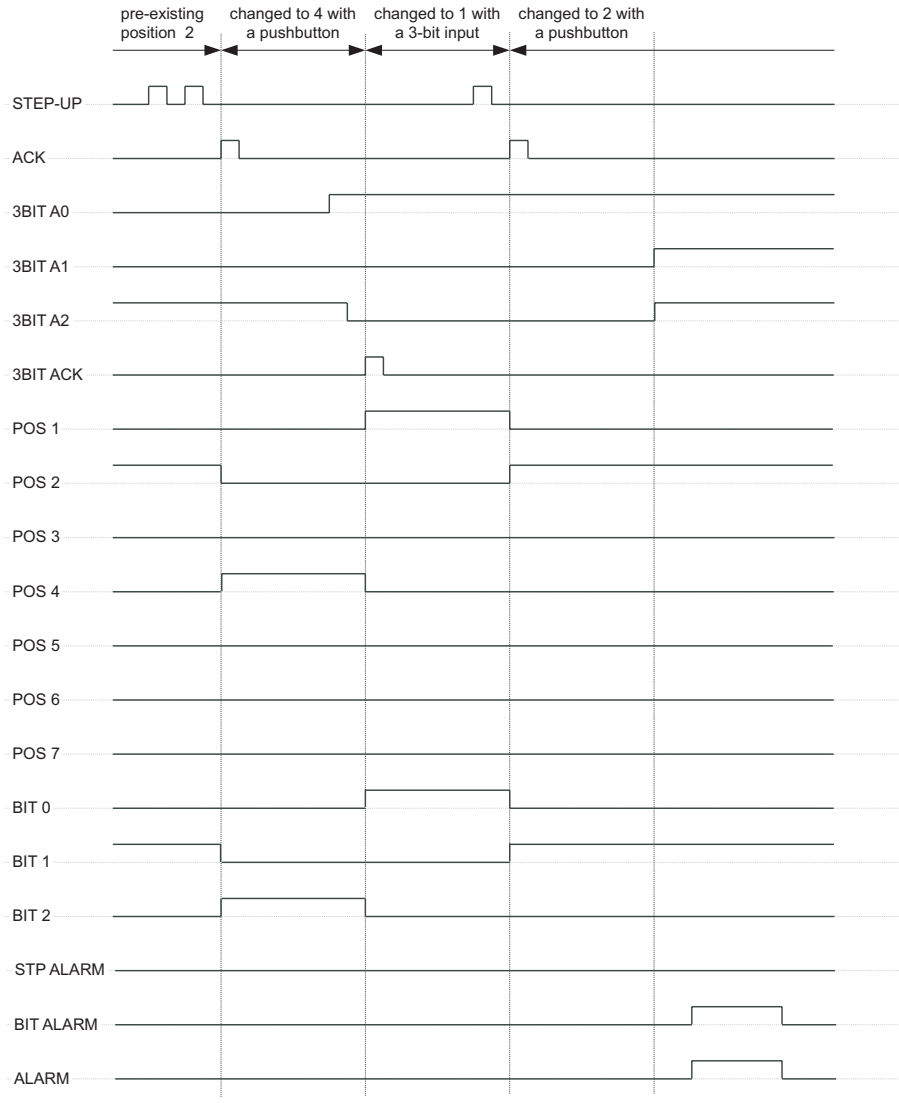

842736A1.CDR

Figure 5-71: ACKNOWLEDGE MODE

APPLICATION EXAMPLE

Consider an application where the selector switch is used to control Setting Groups 1 through 4 in the relay. The setting groups are to be controlled from both User-Programmable Pushbutton 1 and from an external device via Contact Inputs 1 through 3. The active setting group shall be available as an encoded 3-bit word to the external device and SCADA via output contacts 1 through 3. The pre-selected setting group shall be applied automatically after 5 seconds of inactivity of the control inputs. When the relay powers up, it should synchronize the setting group to the 3-bit control input.

Make the following changes to Setting Group Control in the **SETTINGS** ⇨ **CONTROL ELEMENTS** ⇨ **SETTING GROUPS** menu:

- SETTING GROUPS FUNCTION: "Enabled"
- SETTING GROUPS BLK: "Off"
- GROUP 2 ACTIVATE ON: "SELECTOR 1 POS 2"
- GROUP 3 ACTIVATE ON: "SELECTOR 1 POS 3"
- GROUP 4 ACTIVATE ON: "SELECTOR 1 POS 4"
- GROUP 5 ACTIVATE ON: "Off"
- GROUP 6 ACTIVATE ON: "Off"

Make the following changes to Selector Switch element in the **SETTINGS** ⇨ **CONTROL ELEMENTS** ⇨ **SELECTOR SWITCH** ⇨ **SELECTOR SWITCH 1** menu to assign control to User Programmable Pushbutton 1 and Contact Inputs 1 through 3:

- SELECTOR 1 FUNCTION: "Enabled"
- SELECTOR 1 FULL-RANGE: "4"
- SELECTOR 1 STEP-UP MODE: "Time-out"
- SELECTOR 1 TIME-OUT: "5.0 s"
- SELECTOR 1 STEP-UP: "PUSHBUTTON 1 ON"
- SELECTOR 1 ACK: "Off"
- SELECTOR 1 3BIT A0: "CONT IP 1 ON"
- SELECTOR 1 3BIT A1: "CONT IP 2 ON"
- SELECTOR 1 3BIT A2: "CONT IP 3 ON"
- SELECTOR 1 3BIT MODE: "Time-out"
- SELECTOR 1 3BIT ACK: "Off"
- SELECTOR 1 POWER-UP MODE: "Synchronize"

Now, assign the contact output operation (assume the H6E module) to the Selector Switch element by making the following changes in the **SETTINGS** ⇨ **INPUTS/OUTPUTS** ⇨ **CONTACT OUTPUTS** menu:

- OUTPUT H1 OPERATE: "SELECTOR 1 BIT 0"
- OUTPUT H2 OPERATE: "SELECTOR 1 BIT 1"
- OUTPUT H3 OPERATE: "SELECTOR 1 BIT 2"

Finally, assign configure User-Programmable Pushbutton 1 by making the following changes in the **SETTINGS** ⇨ **PRODUCT SETUP** ⇨ **USER-PROGRAMMABLE PUSHBUTTONS** ⇨ **USER PUSHBUTTON 1** menu:

- PUSHBUTTON 1 FUNCTION: "Self-reset"
- PUSHBUTTON 1 DROP-OUT TIME: "0.10 s"

The logic for the selector switch is shown below:

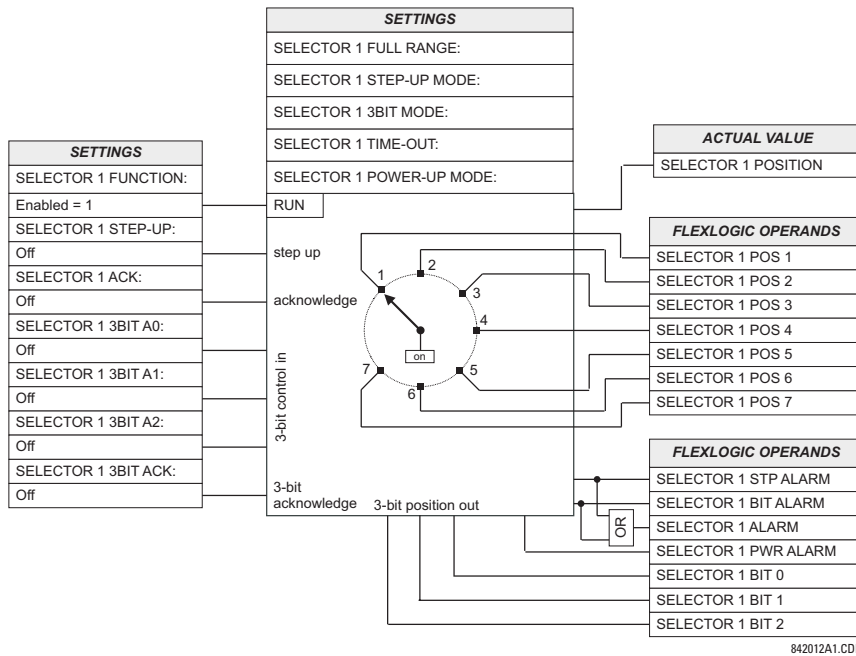

Figure 5-72: SELECTOR SWITCH LOGIC

5.6.4 UNDERFREQUENCY

PATH: SETTINGS ⇌ CONTROL ELEMENTS ⇌ UNDERFREQUENCY ⇌ UNDERFREQUENCY 1(6)

■ UNDERFREQUENCY 1	◀▶	UND FREQ 1 FUNCTION: Disabled	Range: Disabled, Enabled
MESSAGE	▲▼	UND FREQ 1 BLOCK: Off	Range: FlexLogic™ operand
MESSAGE	▲▼	UND FREQ 1 SOURCE: SRC 1	Range: SRC 1, SRC 2, SRC 3, SRC 4
MESSAGE	▲▼	UND FREQ 1 MIN VOLT/AMP: 0.10 pu	Range: 0.10 to 1.25 pu in steps of 0.01
MESSAGE	▲▼	UND FREQ 1 PICKUP: 59.50 Hz	Range: 20.00 to 65.00 Hz in steps of 0.01
MESSAGE	▲▼	UND FREQ 1 PICKUP DELAY: 2.000 s	Range: 0.000 to 65.535 s in steps of 0.001
MESSAGE	▲▼	UND FREQ 1 RESET DELAY : 2.000 s	Range: 0.000 to 65.535 s in steps of 0.001
MESSAGE	▲▼	UND FREQ 1 TARGET: Self-reset	Range: Self-reset, Latched, Disabled
MESSAGE	▲	UND FREQ 1 EVENTS: Disabled	Range: Disabled, Enabled

There are six identical underfrequency elements, numbered from 1 through 6 inclusive.

The steady-state frequency of a power system is a certain indicator of the existing balance between the generated power and the load. Whenever this balance is disrupted through the loss of an important generating unit or the isolation of part of the system from the rest of the system, the effect will be a reduction in frequency. If the control systems of the system generators do not respond fast enough, the system may collapse. A reliable method to quickly restore the balance between load and generation is to automatically disconnect selected loads, based on the actual system frequency. This technique, called "load-shedding", maintains system integrity and minimize widespread outages. After the frequency returns to normal, the load may be automatically or manually restored.

The **UND FREQ 1 SOURCE** setting is used to select the source for the signal to be measured. The element first checks for a live phase voltage available from the selected Source. If voltage is not available, the element attempts to use a phase current. If neither voltage nor current is available, the element will not operate, as it will not measure a parameter above the minimum voltage/current setting.

The **UND FREQ 1 MIN VOLT/AMP** setting selects the minimum per unit voltage or current level required to allow the underfrequency element to operate. This threshold is used to prevent an incorrect operation because there is no signal to measure.

This **UND FREQ 1 PICKUP** setting is used to select the level at which the underfrequency element is to pickup. For example, if the system frequency is 60 Hz and the load shedding is required at 59.5 Hz, the setting will be 59.50 Hz.

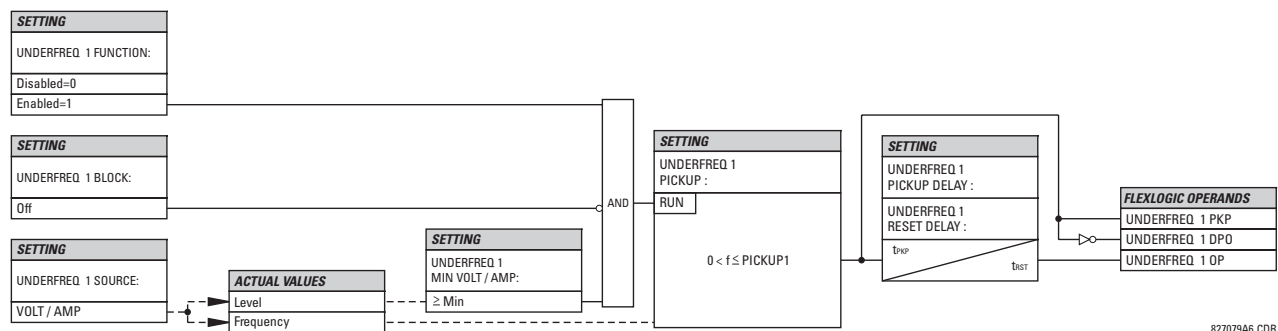

Figure 5-73: UNDERFREQUENCY SCHEME LOGIC

5.6.5 OVERFREQUENCY

PATH: SETTINGS ⇌ CONTROL ELEMENTS ⇌ OVERFREQUENCY ⇌ OVERFREQUENCY 1(4)

OVERFREQUENCY 1	OVERFREQ 1 FUNCTION:	Range: Disabled, Enabled
	Disabled	
MESSAGE	OVERFREQ 1 BLOCK:	Range: FlexLogic™ operand
	Off	
MESSAGE	OVERFREQ 1 SOURCE:	Range: SRC 1, SRC 2, SRC 3, SRC 4
	SRC 1	
MESSAGE	OVERFREQ 1 PICKUP:	Range: 20.00 to 65.00 Hz in steps of 0.01
	60.50 Hz	
MESSAGE	OVERFREQ 1 PICKUP DELAY:	Range: 0.000 to 65.535 s in steps of 0.001
	0.500 s	
MESSAGE	OVERFREQ 1 RESET DELAY :	Range: 0.000 to 65.535 s in steps of 0.001
	0.500 s	
MESSAGE	OVERFREQ 1 TARGET:	Range: Self-reset, Latched, Disabled
	Self-reset	
MESSAGE	OVERFREQ 1 EVENTS:	Range: Disabled, Enabled
	Disabled	

5

There are four overfrequency elements, numbered 1 through 4.

A frequency calculation for a given source is made on the input of a voltage or current channel, depending on which is available. The channels are searched for the signal input in the following order: voltage channel A, auxiliary voltage channel, current channel A, ground current channel. The first available signal is used for frequency calculation.

The steady-state frequency of a power system is an indicator of the existing balance between the generated power and the load. Whenever this balance is disrupted through the disconnection of significant load or the isolation of a part of the system that has a surplus of generation, the effect will be an increase in frequency. If the control systems of the generators do not respond fast enough, to quickly ramp the turbine speed back to normal, the overspeed can lead to the turbine trip. The overfrequency element can be used to control the turbine frequency ramp down at a generating location. This element can also be used for feeder reclosing as part of the "after load shedding restoration".

The **OVERFREQ 1 SOURCE** setting selects the source for the signal to be measured. The **OVERFREQ 1 PICKUP** setting selects the level at which the overfrequency element is to pickup.

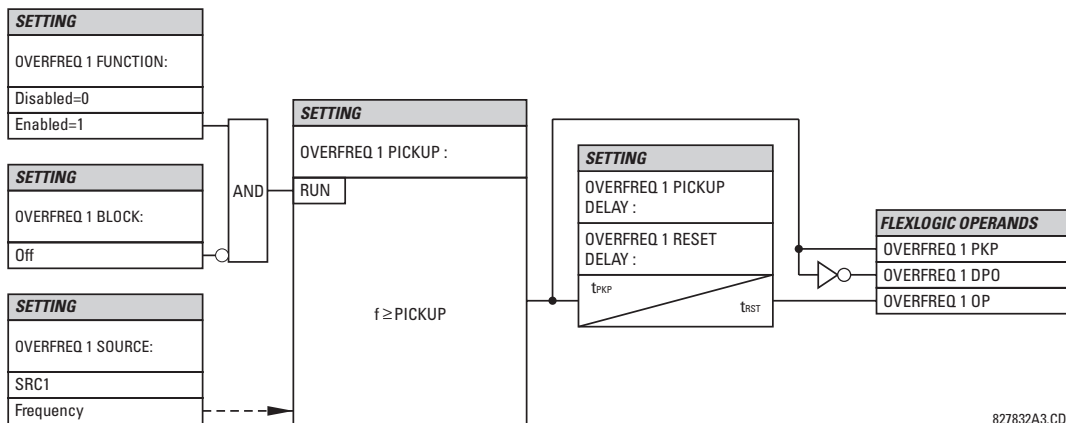

Figure 5-74: OVERFREQUENCY SCHEME LOGIC

827832A3.CDR

5.6.6 DIGITAL ELEMENTS

PATH: SETTINGS ⇌ CONTROL ELEMENTS ⇌ DIGITAL ELEMENTS ⇌ DIGITAL ELEMENT 1(48)

■ DIGITAL ELEMENT 1	◀▶	DIGITAL ELEMENT 1 FUNCTION: Disabled	Range: Disabled, Enabled
MESSAGE	▲▼	DIG ELEM 1 NAME: Dig Element 1	Range: 16 alphanumeric characters
MESSAGE	▲▼	DIG ELEM 1 INPUT: Off	Range: FlexLogic™ operand
MESSAGE	▲▼	DIG ELEM 1 PICKUP DELAY: 0.000 s	Range: 0.000 to 999999.999 s in steps of 0.001
MESSAGE	▲▼	DIG ELEM 1 RESET DELAY: 0.000 s	Range: 0.000 to 999999.999 s in steps of 0.001
MESSAGE	▲▼	DIG ELEMENT 1 PICKUP LED: Enabled	Range: Disabled, Enabled
MESSAGE	▲▼	DIG ELEM 1 BLOCK: Off	Range: FlexLogic™ operand
MESSAGE	▲▼	DIGITAL ELEMENT 1 TARGET: Self-reset	Range: Self-reset, Latched, Disabled
MESSAGE	▲	DIGITAL ELEMENT 1 EVENTS: Disabled	Range: Disabled, Enabled

There are 48 identical digital elements available, numbered 1 to 48. A digital element can monitor any FlexLogic™ operand and present a target message and/or enable events recording depending on the output operand state. The digital element settings include a name which will be referenced in any target message, a blocking input from any selected FlexLogic™ operand, and a timer for pickup and reset delays for the output operand.

- **DIGITAL ELEMENT 1 INPUT:** Selects a FlexLogic™ operand to be monitored by the digital element.
- **DIGITAL ELEMENT 1 PICKUP DELAY:** Sets the time delay to pickup. If a pickup delay is not required, set to "0".
- **DIGITAL ELEMENT 1 RESET DELAY:** Sets the time delay to reset. If a reset delay is not required, set to "0".
- **DIGITAL ELEMENT 1 PICKUP LED:** This setting enables or disabled the digital element pickup LED. When set to "Disabled", the operation of the pickup LED is blocked.

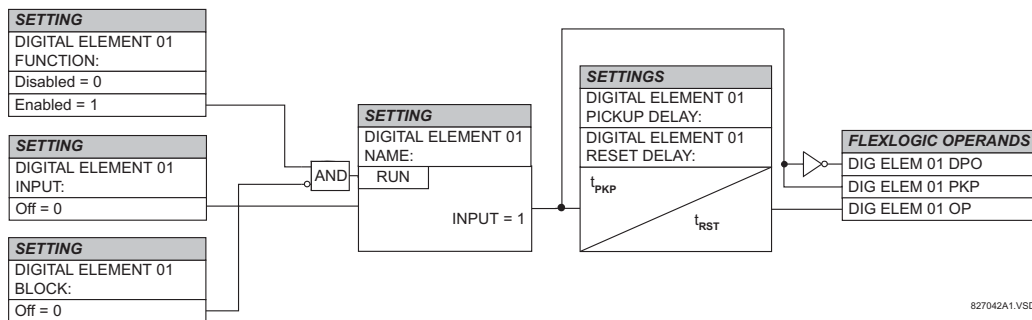

Figure 5-75: DIGITAL ELEMENT SCHEME LOGIC

CIRCUIT MONITORING APPLICATIONS:

Some versions of the digital input modules include an active voltage monitor circuit connected across Form-A contacts. The voltage monitor circuit limits the trickle current through the output circuit (see technical specifications for Form-A).

As long as the current through the Voltage Monitor is above a threshold (see technical specifications for Form-A), the FlexLogic™ operand "Cont Op # VOn" will be set (# represents the output contact number). If the output circuit has a high resistance or the DC current is interrupted, the trickle current will drop below the threshold and the FlexLogic™ operand "Cont Op # VOff" will be set. Consequently, the state of these operands can be used as indicators of the integrity of the circuits in which Form-A contacts are inserted.

EXAMPLE 1: BREAKER TRIP CIRCUIT INTEGRITY MONITORING

In many applications it is desired to monitor the breaker trip circuit integrity so problems can be detected before a trip operation is required. The circuit is considered to be healthy when the voltage monitor connected across the trip output contact detects a low level of current, well below the operating current of the breaker trip coil. If the circuit presents a high resistance, the trickle current will fall below the monitor threshold and an alarm would be declared.

In most breaker control circuits, the trip coil is connected in series with a breaker auxiliary contact which is open when the breaker is open (see diagram below). To prevent unwanted alarms in this situation, the trip circuit monitoring logic must include the breaker position.

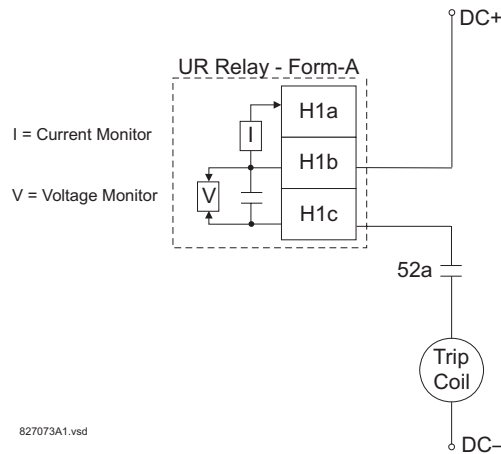

Figure 5-76: TRIP CIRCUIT EXAMPLE 1

Assume the output contact H1 is a trip contact. Using the contact output settings, this output will be given an ID name, e.g. "Cont Op 1". Assume a 52a breaker auxiliary contact is connected to contact input H7a to monitor breaker status. Using the contact input settings, this input will be given an ID name, e.g. "Cont Ip 1" and will be set "On" when the breaker is closed. Using Digital Element 1 to monitor the breaker trip circuit, the settings will be:

■ DIGITAL ELEMENT 1 ■	◀▶	DIGITAL ELEMENT 1 FUNCTION: Enabled
MESSAGE	▲▼	DIG ELEM 1 NAME: Bkr Trip Cct Out
MESSAGE	▲▼	DIG ELEM 1 INPUT: Cont Op 1 Voff
MESSAGE	▲▼	DIG ELEM 1 PICKUP DELAY: 0.200 s
MESSAGE	▲▼	DIG ELEM 1 RESET DELAY: 0.100 s
MESSAGE	▲▼	DIG ELEM 1 BLOCK: Cont Ip 1 Off
MESSAGE	▲▼	DIGITAL ELEMENT 1 TARGET: Self-reset
MESSAGE	▲	DIGITAL ELEMENT 1 EVENTS: Enabled



The PICKUP DELAY setting should be greater than the operating time of the breaker to avoid nuisance alarms.

EXAMPLE 2: BREAKER TRIP CIRCUIT INTEGRITY MONITORING

If it is required to monitor the trip circuit continuously, independent of the breaker position (open or closed), a method to maintain the monitoring current flow through the trip circuit when the breaker is open must be provided (as shown in the figure below). This can be achieved by connecting a suitable resistor (see figure below) across the auxiliary contact in the trip circuit. In this case, it is not required to supervise the monitoring circuit with the breaker position – the BLOCK setting is selected to “Off”. In this case, the settings will be:

■ DIGITAL ELEMENT 1	◀▶	DIGITAL ELEMENT 1 FUNCTION: Enabled
MESSAGE	▲▼	DIG ELEM 1 NAME: Bkr Trip Cct Out
MESSAGE	▲▼	DIG ELEM 1 INPUT: Cont Op 1 Voff
MESSAGE	▲▼	DIG ELEM 1 PICKUP DELAY: 0.200 s
MESSAGE	▲▼	DIG ELEM 1 RESET DELAY: 0.100 s
MESSAGE	▲▼	DIG ELEM 1 BLOCK: Off
MESSAGE	▲▼	DIGITAL ELEMENT 1 TARGET: Self-reset
MESSAGE	▲	DIGITAL ELEMENT 1 EVENTS: Enabled

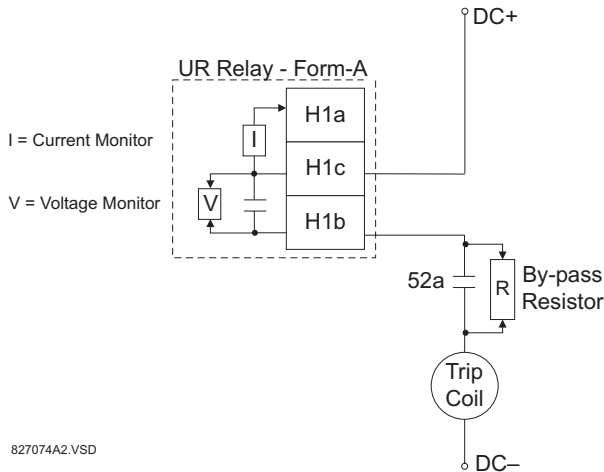

Table 5–22: VALUES OF RESISTOR ‘R’

POWER SUPPLY (V DC)	RESISTANCE (OHMS)	POWER (WATTS)
24	1000	2
30	5000	2
48	10000	2
110	25000	5
125	25000	5
250	50000	5

Figure 5–77: TRIP CIRCUIT EXAMPLE 2

5.6.7 DIGITAL COUNTERS

PATH: SETTINGS ⇌ CONTROL ELEMENTS ⇌ DIGITAL COUNTERS ⇌ COUNTER 1(8)

■ COUNTER 1	◀▶	COUNTER 1 FUNCTION: Disabled	Range: Disabled, Enabled
MESSAGE	▲▼	COUNTER 1 NAME: Counter 1	Range: 12 alphanumeric characters
MESSAGE	▲▼	COUNTER 1 UNITS:	Range: 6 alphanumeric characters
MESSAGE	▲▼	COUNTER 1 PRESET: 0	Range: -2,147,483,648 to +2,147,483,647
MESSAGE	▲▼	COUNTER 1 COMPARE: 0	Range: -2,147,483,648 to +2,147,483,647
MESSAGE	▲▼	COUNTER 1 UP: Off	Range: FlexLogic™ operand
MESSAGE	▲▼	COUNTER 1 DOWN: Off	Range: FlexLogic™ operand
MESSAGE	▲▼	COUNTER 1 BLOCK: Off	Range: FlexLogic™ operand
MESSAGE	▲▼	CNT1 SET TO PRESET: Off	Range: FlexLogic™ operand
MESSAGE	▲▼	COUNTER 1 RESET: Off	Range: FlexLogic™ operand
MESSAGE	▲▼	COUNT1 FREEZE/RESET: Off	Range: FlexLogic™ operand
MESSAGE	▲	COUNT1 FREEZE/COUNT: Off	Range: FlexLogic™ operand

There are 8 identical digital counters, numbered from 1 to 8. A digital counter counts the number of state transitions from Logic 0 to Logic 1. The counter is used to count operations such as the pickups of an element, the changes of state of an external contact (e.g. breaker auxiliary switch), or pulses from a watt-hour meter.

- **COUNTER 1 UNITS:** Assigns a label to identify the unit of measure pertaining to the digital transitions to be counted. The units label will appear in the corresponding actual values status.
- **COUNTER 1 PRESET:** Sets the count to a required preset value before counting operations begin, as in the case where a substitute relay is to be installed in place of an in-service relay, or while the counter is running.
- **COUNTER 1 COMPARE:** Sets the value to which the accumulated count value is compared. Three FlexLogic™ output operands are provided to indicate if the present value is 'more than (HI)', 'equal to (EQL)', or 'less than (LO)' the set value.
- **COUNTER 1 UP:** Selects the FlexLogic™ operand for incrementing the counter. If an enabled UP input is received when the accumulated value is at the limit of +2,147,483,647 counts, the counter will rollover to -2,147,483,648.
- **COUNTER 1 DOWN:** Selects the FlexLogic™ operand for decrementing the counter. If an enabled DOWN input is received when the accumulated value is at the limit of -2,147,483,648 counts, the counter will rollover to +2,147,483,647.
- **COUNTER 1 BLOCK:** Selects the FlexLogic™ operand for blocking the counting operation. All counter operands are blocked.

- CNT1 SET TO PRESET:** Selects the FlexLogic™ operand used to set the count to the preset value. The counter will be set to the preset value in the following situations:
 - When the counter is enabled and the **CNT1 SET TO PRESET** operand has the value 1 (when the counter is enabled and **CNT1 SET TO PRESET** operand is 0, the counter will be set to 0).
 - When the counter is running and the **CNT1 SET TO PRESET** operand changes the state from 0 to 1 (**CNT1 SET TO PRESET** changing from 1 to 0 while the counter is running has no effect on the count).
 - When a reset or reset/freeze command is sent to the counter and the **CNT1 SET TO PRESET** operand has the value 1 (when a reset or reset/freeze command is sent to the counter and the **CNT1 SET TO PRESET** operand has the value 0, the counter will be set to 0).
- COUNTER 1 RESET:** Selects the FlexLogic™ operand for setting the count to either “0” or the preset value depending on the state of the **CNT1 SET TO PRESET** operand.
- COUNTER 1 FREEZE/RESET:** Selects the FlexLogic™ operand for capturing (freezing) the accumulated count value into a separate register with the date and time of the operation, and resetting the count to “0”.
- COUNTER 1 FREEZE/COUNT:** Selects the FlexLogic™ operand for capturing (freezing) the accumulated count value into a separate register with the date and time of the operation, and continuing counting. The present accumulated value and captured frozen value with the associated date/time stamp are available as actual values. If control power is interrupted, the accumulated and frozen values are saved into non-volatile memory during the power down operation.

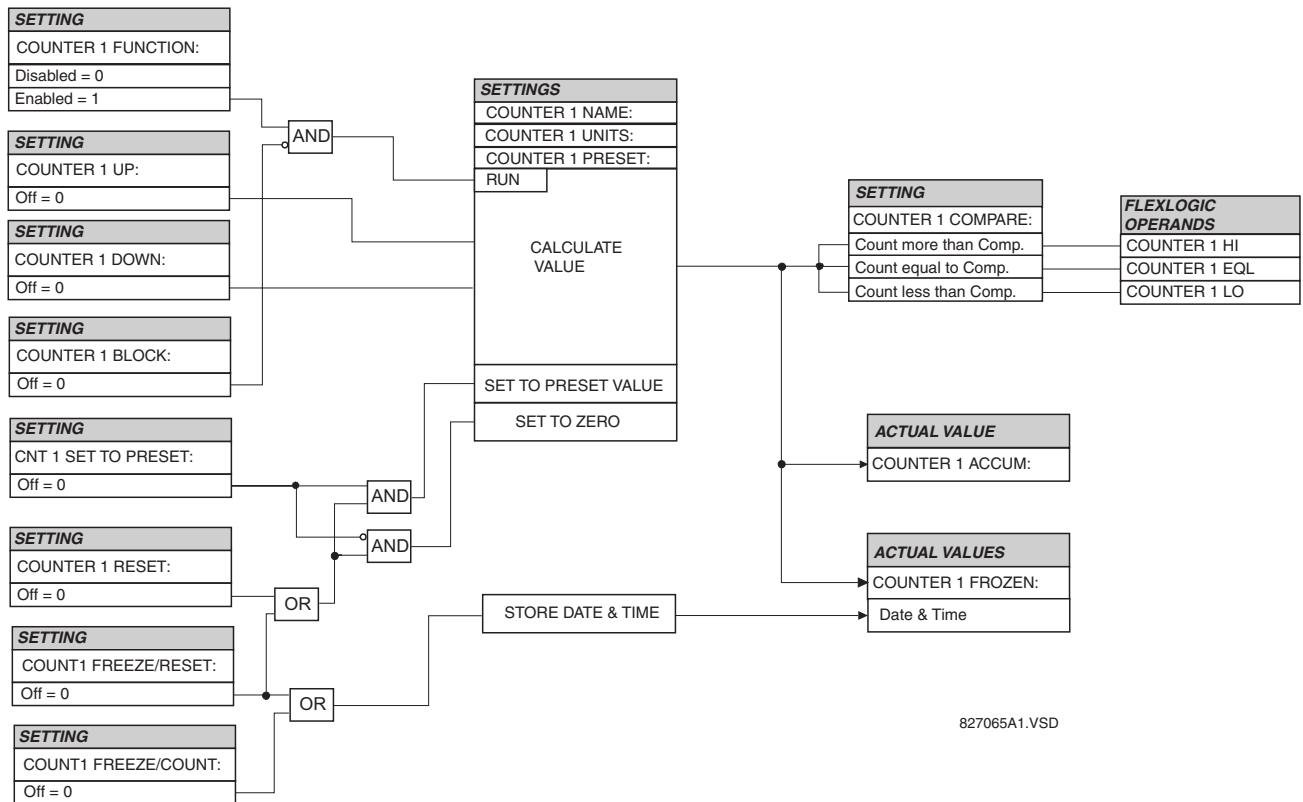

Figure 5-78: DIGITAL COUNTER SCHEME LOGIC

5.6.8 MONITORING ELEMENTS

a) MAIN MENU

PATH: SETTINGS ⇨ CONTROL ELEMENTS ⇨ MONITORING ELEMENTS

<ul style="list-style-type: none"> ■ MONITORING ■ ELEMENTS 	◀▶	<ul style="list-style-type: none"> ■ BREAKER 1 ■ ARCING CURRENT 	See below.
MESSAGE ▲	▲	<ul style="list-style-type: none"> ■ BREAKER 2 ■ ARCING CURRENT 	See below.

b) BREAKER ARCING CURRENT

PATH: SETTINGS ⇨ CONTROL ELEMENTS ⇨ MONITORING ELEMENTS ⇨ BREAKER 1(4) ARCING CURRENT

<ul style="list-style-type: none"> ■ BREAKER 1 ■ ARCING CURRENT 	◀▶	<ul style="list-style-type: none"> BKR 1 ARC AMP FUNCTION: Disabled 	Range: Disabled, Enabled
MESSAGE ▲	▲▼	<ul style="list-style-type: none"> BKR 1 ARC AMP SOURCE: SRC 1 	Range: SRC 1, SRC 2, SRC 3, SRC 4
MESSAGE ▲	▲▼	<ul style="list-style-type: none"> BKR 1 ARC AMP INT-A: Off 	Range: FlexLogic™ operand
MESSAGE ▲	▲▼	<ul style="list-style-type: none"> BKR 1 ARC AMP INT-B: Off 	Range: FlexLogic™ operand
MESSAGE ▲	▲▼	<ul style="list-style-type: none"> BKR 1 ARC AMP INT-C: Off 	Range: FlexLogic™ operand
MESSAGE ▲	▲▼	<ul style="list-style-type: none"> BKR 1 ARC AMP DELAY: 0.000 s 	Range: 0.000 to 65.535 s in steps of 0.001
MESSAGE ▲	▲▼	<ul style="list-style-type: none"> BKR 1 ARC AMP LIMIT: 1000 kA²-cyc 	Range: 0 to 50000 kA ² -cycle in steps of 1
MESSAGE ▲	▲▼	<ul style="list-style-type: none"> BKR 1 ARC AMP BLOCK: Off 	Range: FlexLogic™ operand
MESSAGE ▲	▲▼	<ul style="list-style-type: none"> BKR 1 ARC AMP TARGET: Self-reset 	Range: Self-reset, Latched, Disabled
MESSAGE ▲	▲	<ul style="list-style-type: none"> BKR 1 ARC AMP EVENTS: Disabled 	Range: Disabled, Enabled

There is one Breaker Arcing Current element available per CT bank, with a minimum of 2 elements. This element calculates an estimate of the per-phase wear on the breaker contacts by measuring and integrating the current squared passing through the breaker contacts as an arc. These per-phase values are added to accumulated totals for each phase and compared to a programmed threshold value. When the threshold is exceeded in any phase, the relay can set an output operand to "1". The accumulated value for each phase can be displayed as an actual value.

The operation of the scheme is shown in the following logic diagram. The same output operand that is selected to operate the output relay used to trip the breaker, indicating a tripping sequence has begun, is used to initiate this feature. A time delay is introduced between initiation and the starting of integration to prevent integration of current flow through the breaker before the contacts have parted. This interval includes the operating time of the output relay, any other auxiliary relays and the breaker mechanism. For maximum measurement accuracy, the interval between change-of-state of the operand (from 0 to 1) and contact separation should be measured for the specific installation. Integration of the measured current continues for 100 ms, which is expected to include the total arcing period.

The feature is programmed to perform fault duration calculations. Fault duration is defined as a time between operation of the disturbance detector occurring before initiation of this feature, and reset of an internal low-set overcurrent function. Correction is implemented to account for a non-zero reset time of the overcurrent function.

Breaker arcing currents and fault duration values are available under the **ACTUAL VALUES** ⇨ **RECORDS** ⇨ **MAINTENANCE** ⇨ **BREAKER 1(4)** menus.

- **BKR 1(4) ARC AMP INT-A(C):** Select the same output operands that are configured to operate the output relays used to trip the breaker. In three-pole tripping applications, the same operand should be configured to initiate arcing current calculations for poles A, B and C of the breaker. In single-pole tripping applications, per-pole tripping operands should be configured to initiate the calculations for the poles that are actually tripped.
- **BKR 1(4) ARC AMP DELAY:** This setting is used to program the delay interval between the time the tripping sequence is initiated and the time the breaker contacts are expected to part, starting the integration of the measured current.
- **BKR 1(4) ARC AMP LIMIT:** Selects the threshold value above which the output operand is set.

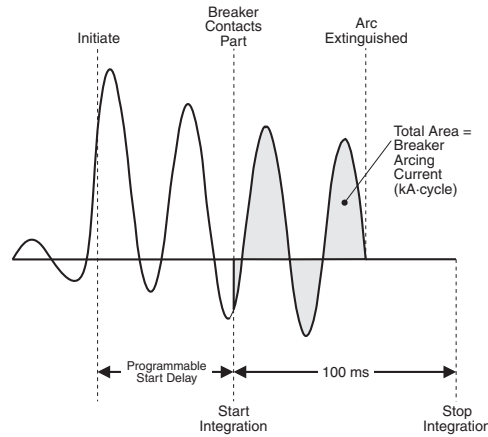

Figure 5-79: ARCING CURRENT MEASUREMENT

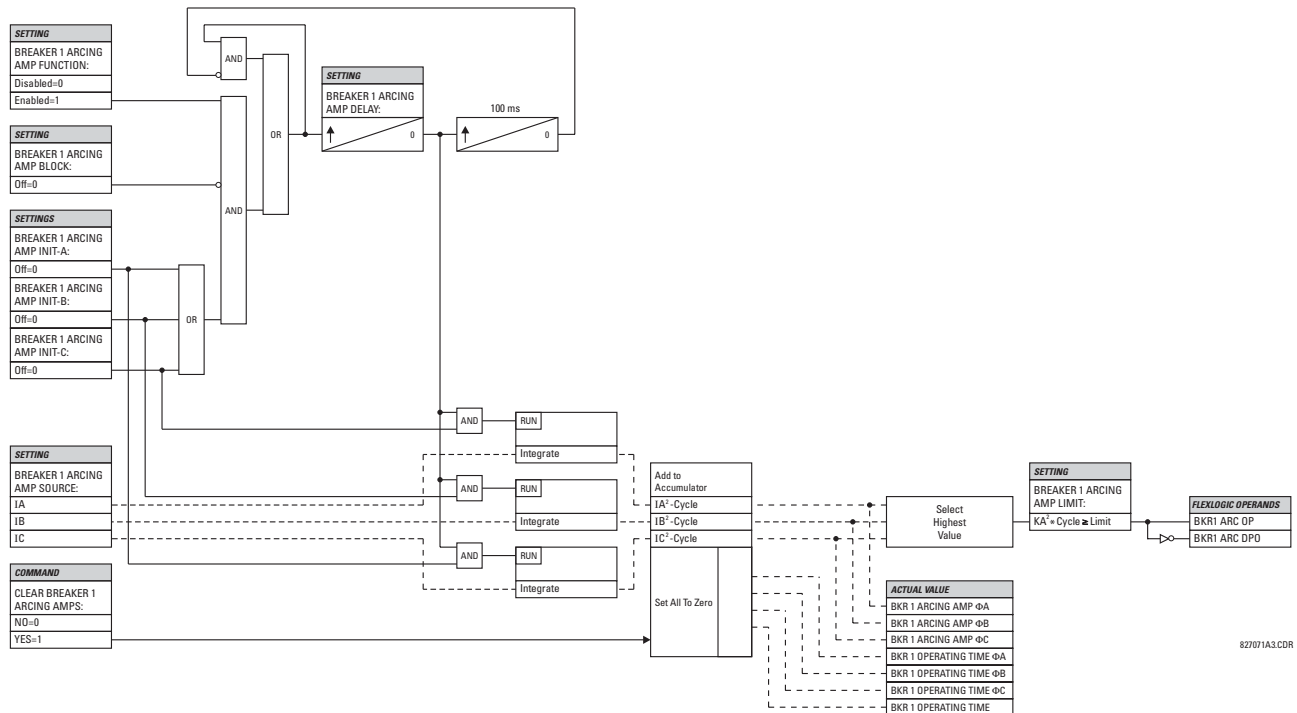
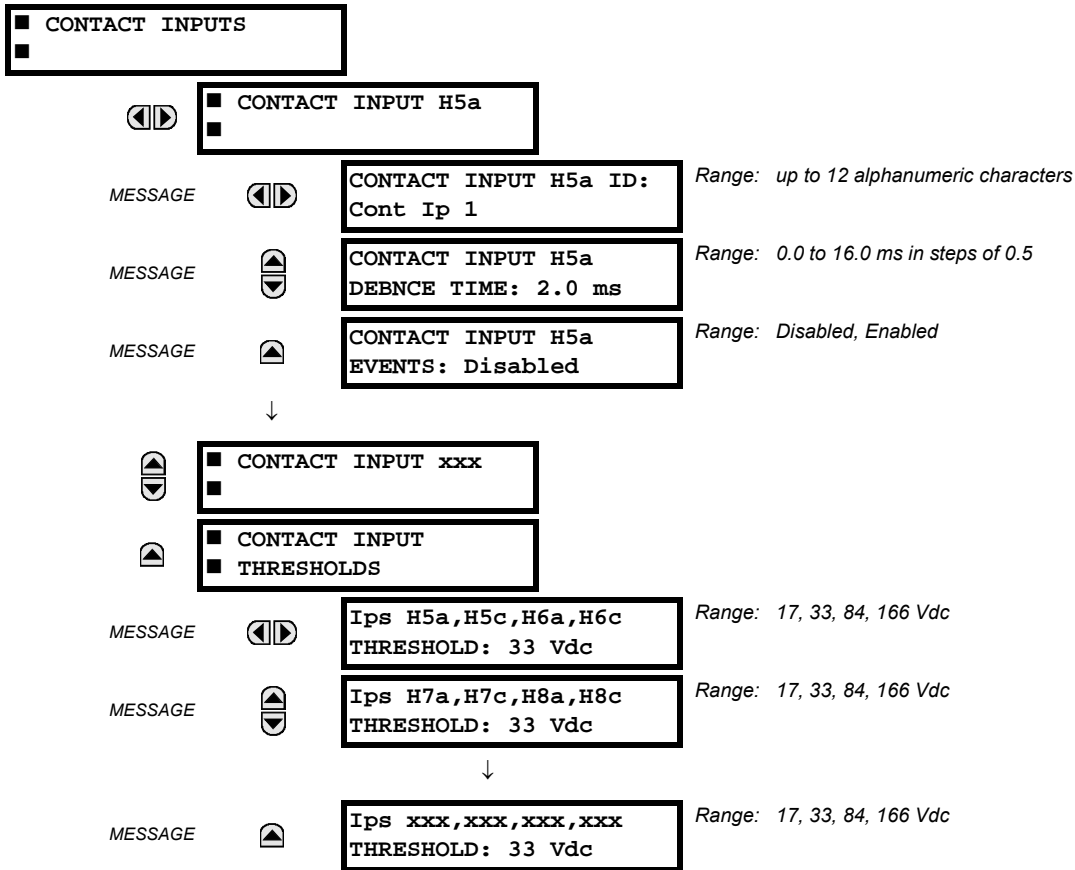

Figure 5-80: BREAKER ARCING CURRENT SCHEME LOGIC

5.7.1 CONTACT INPUTS

PATH: SETTINGS ⇒ INPUTS/OUTPUTS ⇒ CONTACT INPUTS



The contact inputs menu contains configuration settings for each contact input as well as voltage thresholds for each group of four contact inputs. Upon startup, the relay processor determines (from an assessment of the installed modules) which contact inputs are available and then display settings for only those inputs.

An alphanumeric ID may be assigned to a contact input for diagnostic, setting, and event recording purposes. The CONTACT IP X On™ (Logic 1) FlexLogic™ operand corresponds to contact input “X” being closed, while CONTACT IP X Off corresponds to contact input “X” being open. The **CONTACT INPUT DEBNCE TIME** defines the time required for the contact to overcome ‘contact bouncing’ conditions. As this time differs for different contact types and manufacturers, set it as a maximum contact debounce time (per manufacturer specifications) plus some margin to ensure proper operation. If **CONTACT INPUT EVENTS** is set to “Enabled”, every change in the contact input state will trigger an event.

A raw status is scanned for all Contact Inputs synchronously at the constant rate of 0.5 ms as shown in the figure below. The DC input voltage is compared to a user-settable threshold. A new contact input state must be maintained for a user-settable debounce time in order for the T60 to validate the new contact state. In the figure below, the debounce time is set at 2.5 ms; thus the 6th sample in a row validates the change of state (mark no. 1 in the diagram). Once validated (debounced), the contact input asserts a corresponding FlexLogic™ operand and logs an event as per user setting.

A time stamp of the first sample in the sequence that validates the new state is used when logging the change of the contact input into the Event Recorder (mark no. 2 in the diagram).

Protection and control elements, as well as FlexLogic™ equations and timers, are executed eight times in a power system cycle. The protection pass duration is controlled by the frequency tracking mechanism. The FlexLogic™ operand reflecting the debounced state of the contact is updated at the protection pass following the validation (marks no. 3 and 4 on the figure below). The update is performed at the beginning of the protection pass so all protection and control functions, as well as FlexLogic™ equations, are fed with the updated states of the contact inputs.

The FlexLogic™ operand response time to the contact input change is equal to the debounce time setting plus up to one protection pass (variable and depending on system frequency if frequency tracking enabled). If the change of state occurs just after a protection pass, the recognition is delayed until the subsequent protection pass; that is, by the entire duration of the protection pass. If the change occurs just prior to a protection pass, the state is recognized immediately. Statistically a delay of half the protection pass is expected. Owing to the 0.5 ms scan rate, the time resolution for the input contact is below 1msec.

For example, 8 protection passes per cycle on a 60 Hz system correspond to a protection pass every 2.1 ms. With a contact debounce time setting of 3.0 ms, the FlexLogic™ operand-assert time limits are: $3.0 + 0.0 = 3.0$ ms and $3.0 + 2.1 = 5.1$ ms. These time limits depend on how soon the protection pass runs after the debouncing time.

Regardless of the contact debounce time setting, the contact input event is time-stamped with a 1 μs accuracy using the time of the first scan corresponding to the new state (mark no. 2 below). Therefore, the time stamp reflects a change in the DC voltage across the contact input terminals that was not accidental as it was subsequently validated using the debounce timer. Keep in mind that the associated FlexLogic™ operand is asserted/de-asserted later, after validating the change.

The debounce algorithm is symmetrical: the same procedure and debounce time are used to filter the LOW-HIGH (marks no. 1, 2, 3, and 4 in the figure below) and HIGH-LOW (marks no. 5, 6, 7, and 8 below) transitions.

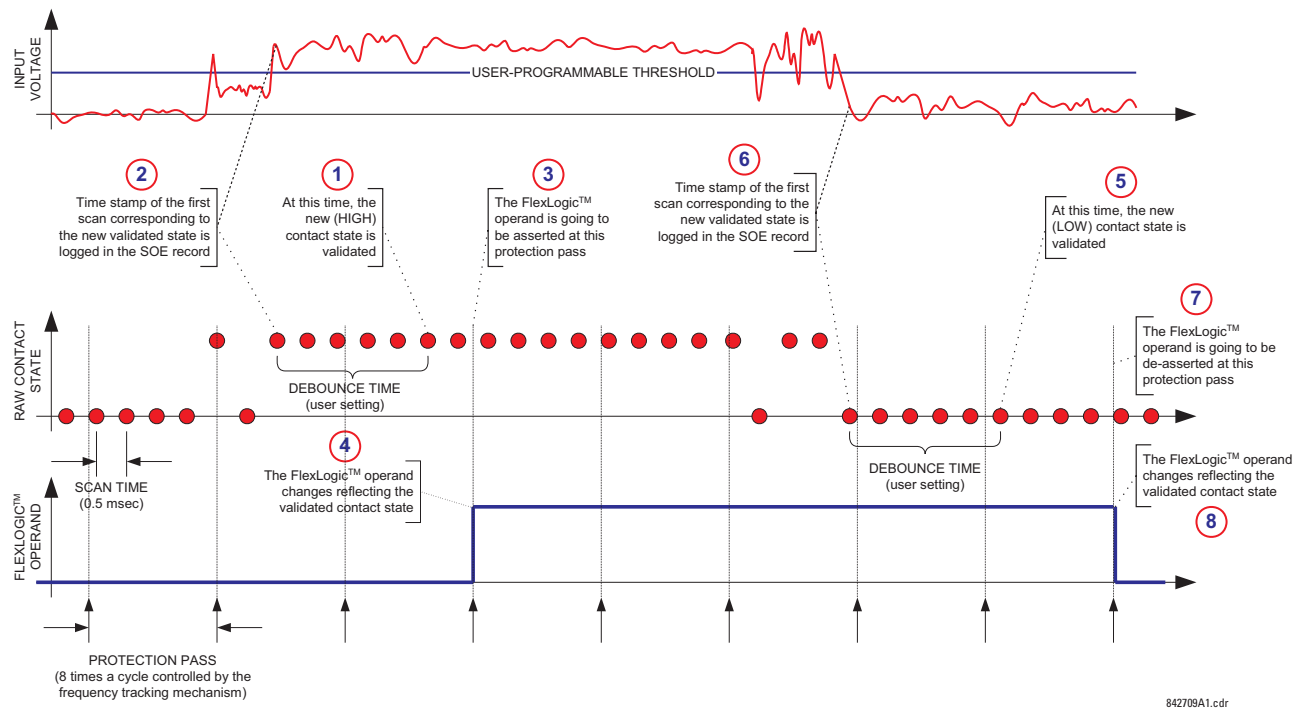

Figure 5-81: INPUT CONTACT DEBOUNCING MECHANISM AND TIME-STAMPING SAMPLE TIMING

Contact inputs are isolated in groups of four to allow connection of wet contacts from different voltage sources for each group. The **CONTACT INPUT THRESHOLDS** determine the minimum voltage required to detect a closed contact input. This value should be selected according to the following criteria: 17 for 24 V sources, 33 for 48 V sources, 84 for 110 to 125 V sources and 166 for 250 V sources.

For example, to use contact input H5a as a status input from the breaker 52b contact to seal-in the trip relay and record it in the Event Records menu, make the following settings changes:

CONTACT INPUT H5A ID: "Breaker Closed (52b)"

CONTACT INPUT H5A EVENTS: "Enabled"

Note that the 52b contact is closed when the breaker is open and open when the breaker is closed.

5.7.2 VIRTUAL INPUTS

PATH: SETTINGS ⇄ INPUTS/OUTPUTS ⇄ VIRTUAL INPUTS ⇄ VIRTUAL INPUT 1(64)

<p>■ VIRTUAL INPUT 1</p>	<p>◀ ▶</p>	<p>VIRTUAL INPUT 1 FUNCTION: Disabled</p>	<p>Range: Disabled, Enabled</p>
MESSAGE	<p>▲ ▼</p>	<p>VIRTUAL INPUT 1 ID: Virt Ip 1</p>	<p>Range: Up to 12 alphanumeric characters</p>
MESSAGE	<p>▲ ▼</p>	<p>VIRTUAL INPUT 1 TYPE: Latched</p>	<p>Range: Self-Reset, Latched</p>
MESSAGE	<p>▲</p>	<p>VIRTUAL INPUT 1 EVENTS: Disabled</p>	<p>Range: Disabled, Enabled</p>

There are 64 virtual inputs that can be individually programmed to respond to input signals from the keypad (Commands menu) and communications protocols. All virtual input operands are defaulted to OFF = 0 unless the appropriate input signal is received. **Virtual input states are preserved through a control power loss.**

If the **VIRTUAL INPUT x FUNCTION** is to “Disabled”, the input will be forced to 'Off' (Logic 0) regardless of any attempt to alter the input. If set to “Enabled”, the input operates as shown on the logic diagram and generates output FlexLogic™ operands in response to received input signals and the applied settings.

There are two types of operation: Self-Reset and Latched. If **VIRTUAL INPUT x TYPE** is “Self-Reset”, when the input signal transits from OFF = 0 to ON = 1, the output operand will be set to ON = 1 for only one evaluation of the FlexLogic™ equations and then return to OFF = 0. If set to “Latched”, the virtual input sets the state of the output operand to the same state as the most recent received input, ON =1 or OFF = 0.

5



The “Self-Reset” operating mode generates the output operand for a single evaluation of the FlexLogic™ equations. If the operand is to be used anywhere other than internally in a FlexLogic™ equation, it will likely have to be lengthened in time. A FlexLogic™ timer with a delayed reset can perform this function.

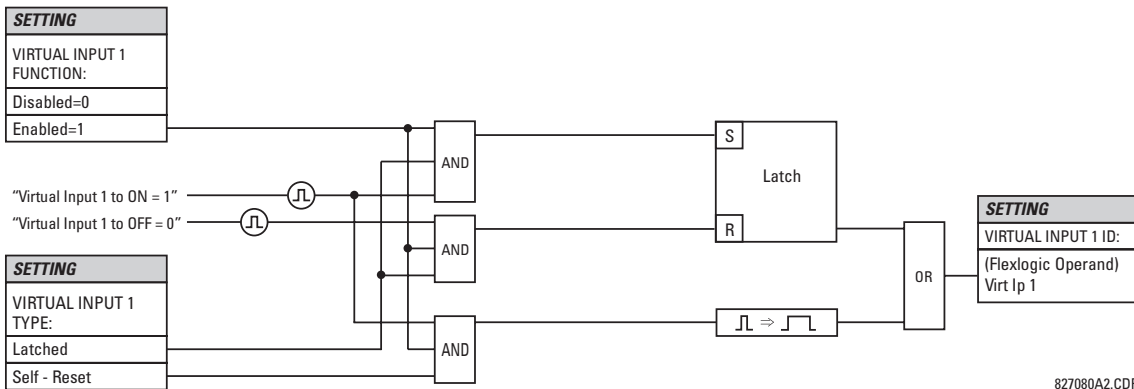

Figure 5-82: VIRTUAL INPUTS SCHEME LOGIC

5.7.3 CONTACT OUTPUTS

a) DIGITAL OUTPUTS

PATH: SETTINGS ⇨ INPUTS/OUTPUTS ⇨ CONTACT OUTPUTS ⇨ CONTACT OUTPUT H1

■ CONTACT OUTPUT H1	◀▶	CONTACT OUTPUT H1 ID Cont Op 1	Range: Up to 12 alphanumeric characters
MESSAGE	▲▼	OUTPUT H1 OPERATE: Off	Range: FlexLogic™ operand
MESSAGE	▲▼	OUTPUT H1 SEAL-IN: Off	Range: FlexLogic™ operand
MESSAGE	▲	CONTACT OUTPUT H1 EVENTS: Enabled	Range: Disabled, Enabled

Upon startup of the relay, the main processor will determine from an assessment of the modules installed in the chassis which contact outputs are available and present the settings for only these outputs.

An ID may be assigned to each contact output. The signal that can **OPERATE** a contact output may be any FlexLogic™ operand (virtual output, element state, contact input, or virtual input). An additional FlexLogic™ operand may be used to **SEAL-IN** the relay. Any change of state of a contact output can be logged as an Event if programmed to do so.

For example, the trip circuit current is monitored by providing a current threshold detector in series with some Form-A contacts (see the trip circuit example in the *Digital Elements* section). The monitor will set a flag (see the specifications for Form-A). The name of the FlexLogic™ operand set by the monitor, consists of the output relay designation, followed by the name of the flag; e.g. 'Cont Op 1 IOn' or 'Cont Op 1 IOff'.

In most breaker control circuits, the trip coil is connected in series with a breaker auxiliary contact used to interrupt current flow after the breaker has tripped, to prevent damage to the less robust initiating contact. This can be done by monitoring an auxiliary contact on the breaker which opens when the breaker has tripped, but this scheme is subject to incorrect operation caused by differences in timing between breaker auxiliary contact change-of-state and interruption of current in the trip circuit. The most dependable protection of the initiating contact is provided by directly measuring current in the tripping circuit, and using this parameter to control resetting of the initiating relay. This scheme is often called 'trip seal-in'.

This can be realized in the T60 using the 'Cont Op 1 IOn' FlexLogic™ operand to seal-in the contact output as follows:

CONTACT OUTPUT H1 ID: "Cont Op 1"
 OUTPUT H1 OPERATE: any suitable FlexLogic™ operand
 OUTPUT H1 SEAL-IN: "Cont Op 1 IOn"
 CONTACT OUTPUT H1 EVENTS: "Enabled"

b) LATCHING OUTPUTS

PATH: SETTINGS ⇨ INPUTS/OUTPUTS ⇨ CONTACT OUTPUTS ⇨ CONTACT OUTPUT H1a

■ CONTACT OUTPUT H1a	◀▶	OUTPUT H1a ID L-Cont Op 1	Range: Up to 12 alphanumeric characters
MESSAGE	▲▼	OUTPUT H1a OPERATE: Off	Range: FlexLogic™ operand
MESSAGE	▲▼	OUTPUT H1a RESET: Off	Range: FlexLogic™ operand
MESSAGE	▲▼	OUTPUT H1a TYPE: Operate-dominant	Range: Operate-dominant, Reset-dominant
MESSAGE	▲	OUTPUT H1a EVENTS: Disabled	Range: Disabled, Enabled

The T60 latching output contacts are mechanically bi-stable and controlled by two separate (open and close) coils. As such they retain their position even if the relay is not powered up. The relay recognizes all latching output contact cards and populates the setting menu accordingly. On power up, the relay reads positions of the latching contacts from the hardware before executing any other functions of the relay (such as protection and control features or FlexLogic™).

The latching output modules, either as a part of the relay or as individual modules, are shipped from the factory with all latching contacts opened. It is highly recommended to double-check the programming and positions of the latching contacts when replacing a module.

Since the relay asserts the output contact and reads back its position, it is possible to incorporate self-monitoring capabilities for the latching outputs. If any latching outputs exhibits a discrepancy, the **LATCHING OUTPUT ERROR** self-test error is declared. The error is signaled by the **LATCHING OUT ERROR** FlexLogic™ operand, event, and target message.

- **OUTPUT H1a OPERATE:** This setting specifies a FlexLogic™ operand to operate the 'close coil' of the contact. The relay will seal-in this input to safely close the contact. Once the contact is closed and the **RESET** input is logic 0 (off), any activity of the **OPERATE** input, such as subsequent chattering, will not have any effect. With both the **OPERATE** and **RESET** inputs active (logic 1), the response of the latching contact is specified by the **OUTPUT H1A TYPE** setting.
- **OUTPUT H1a RESET:** This setting specifies a FlexLogic™ operand to operate the 'trip coil' of the contact. The relay will seal-in this input to safely open the contact. Once the contact is opened and the **OPERATE** input is logic 0 (off), any activity of the **RESET** input, such as subsequent chattering, will not have any effect. With both the **OPERATE** and **RESET** inputs active (logic 1), the response of the latching contact is specified by the **OUTPUT H1A TYPE** setting.
- **OUTPUT H1a TYPE:** This setting specifies the contact response under conflicting control inputs; that is, when both the **OPERATE** and **RESET** signals are applied. With both control inputs applied simultaneously, the contact will close if set to "Operate-dominant" and will open if set to "Reset-dominant".

Application Example 1:

A latching output contact H1a is to be controlled from two user-programmable pushbuttons (buttons number 1 and 2). The following settings should be applied.

Program the Latching Outputs by making the following changes in the **SETTINGS** ⇨⇩ **INPUTS/OUTPUTS** ⇨⇩ **CONTACT OUTPUTS** ⇨ **CONTACT OUTPUT H1a** menu (assuming an H4L module):

OUTPUT H1a OPERATE: "PUSHBUTTON 1 ON"
OUTPUT H1a RESET: "PUSHBUTTON 2 ON"

Program the pushbuttons by making the following changes in the **PRODUCT SETUP** ⇨⇩ **USER-PROGRAMMABLE PUSHBUTTONS** ⇨⇩ **USER PUSHBUTTON 1** and **USER PUSHBUTTON 2** menus:

PUSHBUTTON 1 FUNCTION: "Self-reset" **PUSHBUTTON 2 FUNCTION:** "Self-reset"
PUSHBTN 1 DROP-OUT TIME: "0.00 s" **PUSHBTN 2 DROP-OUT TIME:** "0.00 s"

Application Example 2:

A relay, having two latching contacts H1a and H1c, is to be programmed. The H1a contact is to be a Type-a contact, while the H1c contact is to be a Type-b contact (Type-a means closed after exercising the operate input; Type-b means closed after exercising the reset input). The relay is to be controlled from virtual outputs: VO1 to operate and VO2 to reset.

Program the Latching Outputs by making the following changes in the **SETTINGS** ⇨⇩ **INPUTS/OUTPUTS** ⇨⇩ **CONTACT OUTPUTS** ⇨ **CONTACT OUTPUT H1a** and **CONTACT OUTPUT H1c** menus (assuming an H4L module):

OUTPUT H1a OPERATE: "VO1" **OUTPUT H1c OPERATE:** "VO2"
OUTPUT H1a RESET: "VO2" **OUTPUT H1c RESET:** "VO1"

Since the two physical contacts in this example are mechanically separated and have individual control inputs, they will not operate at exactly the same time. A discrepancy in the range of a fraction of a maximum operating time may occur. Therefore, a pair of contacts programmed to be a multi-contact relay will not guarantee any specific sequence of operation (such as make before break). If required, the sequence of operation must be programmed explicitly by delaying some of the control inputs as shown in the next application example.

Application Example 3:

A make before break functionality must be added to the preceding example. An overlap of 20 ms is required to implement this functionality as described below:

Write the following FlexLogic™ equation (EnerVista UR Setup example shown):

FLEXLOGIC ENTRY	TYPE	SYNTAX
View Graphic	View	View
FlexLogic Entry 1	Read Virtual Outputs On	Virt Op 1 On (VO1)
FlexLogic Entry 2	TIMER	Timer 1
FlexLogic Entry 3	Write Virtual Output[Assign]	= Virt Op 3 (VO3)
FlexLogic Entry 4	Read Virtual Outputs On	Virt Op 2 On (VO2)
FlexLogic Entry 5	TIMER	Timer 2
FlexLogic Entry 6	Write Virtual Output[Assign]	= Virt Op 4 (VO4)
FlexLogic Entry 7	End of List	

Both timers (Timer 1 and Timer 2) should be set to 20 ms pickup and 0 ms dropout.

Program the Latching Outputs by making the following changes in the **SETTINGS** ⇒ **INPUTS/OUTPUTS** ⇒ **CONTACT OUTPUTS** ⇒ **CONTACT OUTPUT H1a** and **CONTACT OUTPUT H1c** menus (assuming an H4L module):

OUTPUT H1a OPERATE: "VO1"
OUTPUT H1a RESET: "VO4"

OUTPUT H1c OPERATE: "VO2"
OUTPUT H1c RESET: "VO3"

Application Example 4:

A latching contact H1a is to be controlled from a single virtual output VO1. The contact should stay closed as long as VO1 is high, and should stay opened when VO1 is low. Program the relay as follows.

Write the following FlexLogic™ equation (EnerVista UR Setup example shown):

FLEXLOGIC ENTRY	TYPE	SYNTAX
View Graphic	View	View
FlexLogic Entry 1	Read Virtual Outputs On	Virt Op 1 On (VO1)
FlexLogic Entry 2	NOT	1 Input
FlexLogic Entry 3	Write Virtual Output[Assign]	= Virt Op 2 (VO2)
FlexLogic Entry 4	End of List	

Program the Latching Outputs by making the following changes in the **SETTINGS** ⇒ **INPUTS/OUTPUTS** ⇒ **CONTACT OUTPUTS** ⇒ **CONTACT OUTPUT H1a** menu (assuming an H4L module):

OUTPUT H1a OPERATE: "VO1"
OUTPUT H1a RESET: "VO2"

5.7.4 VIRTUAL OUTPUTS

PATH: **SETTINGS** ⇒ **INPUTS/OUTPUTS** ⇒ **VIRTUAL OUTPUTS** ⇒ **VIRTUAL OUTPUT 1(96)**

<input type="checkbox"/> VIRTUAL OUTPUT 1	◀▶	VIRTUAL OUTPUT 1 ID Virt Op 1	Range: Up to 12 alphanumeric characters
MESSAGE	▲	VIRTUAL OUTPUT 1 EVENTS: Disabled	Range: Disabled, Enabled

There are 96 virtual outputs that may be assigned via FlexLogic™. If not assigned, the output will be forced to 'OFF' (Logic 0). An ID may be assigned to each virtual output. Virtual outputs are resolved in each pass through the evaluation of the FlexLogic™ equations. Any change of state of a virtual output can be logged as an event if programmed to do so.

For example, if Virtual Output 1 is the trip signal from FlexLogic™ and the trip relay is used to signal events, the settings would be programmed as follows:

VIRTUAL OUTPUT 1 ID: "Trip"
VIRTUAL OUTPUT 1 EVENTS: "Disabled"

5.7.5 REMOTE DEVICES

a) REMOTE INPUTS/OUTPUTS OVERVIEW

Remote inputs and outputs provide a means of exchanging digital state information between Ethernet-networked devices. The IEC 61850 GSSE (Generic Substation State Event) and GOOSE (Generic Object Oriented Substation Event) standards are used.



The IEC 61850 specification requires that communications between devices be implemented on Ethernet. For UR-series relays, Ethernet communications is provided only all CPU modules except type 9E.

The sharing of digital point state information between GSSE/GOOSE equipped relays is essentially an extension to FlexLogic™, allowing distributed FlexLogic™ by making operands available to/from devices on a common communications network. In addition to digital point states, GSSE/GOOSE messages identify the originator of the message and provide other information required by the communication specification. All devices listen to network messages and capture data only from messages that have originated in selected devices.

IEC 61850 GSSE messages are compatible with UCA GOOSE messages and contain a fixed set of digital points. IEC 61850 GOOSE messages can, in general, contain any configurable data items. When used by the remote input/output feature, IEC 61850 GOOSE messages contain the same data as GSSE messages.

Both GSSE and GOOSE messages are designed to be short, reliable, and high priority. GOOSE messages have additional advantages over GSSE messages due to their support of VLAN (virtual LAN) and Ethernet priority tagging functionality. The GSSE message structure contains space for 128 bit pairs representing digital point state information. The IEC 61850 specification provides 32 “DNA” bit pairs that represent the state of two pre-defined events and 30 user-defined events. All remaining bit pairs are “UserSt” bit pairs, which are status bits representing user-definable events. The T60 implementation provides 32 of the 96 available UserSt bit pairs.

The IEC 61850 specification includes features that are used to cope with the loss of communication between transmitting and receiving devices. Each transmitting device will send a GSSE/GOOSE message upon a successful power-up, when the state of any included point changes, or after a specified interval (the *default update* time) if a change-of-state has not occurred. The transmitting device also sends a ‘hold time’ which is set greater than three times the programmed default time required by the receiving device.

Receiving devices are constantly monitoring the communications network for messages they require, as recognized by the identification of the originating device carried in the message. Messages received from remote devices include the message *time allowed to live*. The receiving relay sets a timer assigned to the originating device to this time interval, and if it has not received another message from this device at time-out, the remote device is declared to be non-communicating, so it will use the programmed default state for all points from that specific remote device. If a message is received from a remote device before the *time allowed to live* expires, all points for that device are updated to the states contained in the message and the hold timer is restarted. The status of a remote device, where “Offline” indicates non-communicating, can be displayed.

The remote input/output facility provides for 32 remote inputs and 64 remote outputs.

b) LOCAL DEVICES: ID OF DEVICE FOR TRANSMITTING GSSE MESSAGES

In a T60 relay, the device ID that identifies the originator of the message is programmed in the **SETTINGS** ⇒ **PRODUCT SETUP** ⇒ **INSTALLATION** ⇒ **RELAY NAME** setting.

c) REMOTE DEVICES - ID OF DEVICE FOR RECEIVING GSSE MESSAGES

PATH: **SETTINGS** ⇒ **INPUTS/OUTPUTS** ⇒ **REMOTE DEVICES** ⇒ **REMOTE DEVICE 1(16)**

<div style="border: 1px solid black; padding: 2px;"> ■ REMOTE DEVICE 1 ■ </div>		<div style="border: 1px solid black; padding: 2px;"> REMOTE DEVICE 1 ID: Remote Device 1 </div>	<i>Range: up to 20 alphanumeric characters</i>
MESSAGE		<div style="border: 1px solid black; padding: 2px;"> REMOTE DEVICE 1 VLAN ID: 0 </div>	<i>Range: 0 to 4095 in steps of 1</i>
MESSAGE		<div style="border: 1px solid black; padding: 2px;"> REMOTE DEVICE 1 ETYPE APPID: 0 </div>	<i>Range: 0 to 16383 in steps of 1</i>

Sixteen remote devices, numbered from 1 to 16, can be selected for setting purposes. A receiving relay must be programmed to capture messages from only those originating remote devices of interest. This setting is used to select specific remote devices by entering (bottom row) the exact identification (ID) assigned to those devices.

The **REMOTE DEVICE 1(16) VLAN ID** and **REMOTE DEVICE 1(16) ETYPE APPID** settings are only used with GOOSE messages; they are not applicable to GSSE messages. The **REMOTE DEVICE 1(16) VLAN ID** setting identifies the virtual LAN on which the remote device is sending the GOOSE message. The **REMOTE DEVICE 1(16) ETYPE APPID** setting identifies the Ethernet application identification in the GOOSE message. These settings should match the corresponding settings on the sending device.

5.7.6 REMOTE INPUTS

PATH: SETTINGS ⇨ INPUTS/OUTPUTS ⇨ REMOTE INPUTS ⇨ REMOTE INPUT 1(32)

■ REMOTE INPUT 1	◀▶	REMOTE INPUT 1 ID: Remote Ip 1	Range: up to 12 alphanumeric characters
MESSAGE	▲▼	REMOTE IN 1 DEVICE: Remote Device 1	Range: 1 to 16 inclusive
MESSAGE	▲▼	REMOTE IN 1 BIT PAIR: None	Range: None, DNA-1 to DNA-32, UserSt-1 to UserSt-32
MESSAGE	▲▼	REMOTE IN 1 DEFAULT STATE: Off	Range: On, Off, Latest/On, Latest/Off
MESSAGE	▲	REMOTE IN 1 EVENTS: Disabled	Range: Disabled, Enabled

Remote Inputs which create FlexLogic™ operands at the receiving relay, are extracted from GSSE/GOOSE messages originating in remote devices. The relay provides 32 remote inputs, each of which can be selected from a list consisting of 64 selections: DNA-1 through DNA-32 and UserSt-1 through UserSt-32. The function of DNA inputs is defined in the IEC 61850 specification and is presented in the IEC 61850 DNA Assignments table in the *Remote Outputs* section. The function of UserSt inputs is defined by the user selection of the FlexLogic™ operand whose state is represented in the GSSE/GOOSE message. A user must program a DNA point from the appropriate FlexLogic™ operand.

Remote Input 1 must be programmed to replicate the logic state of a specific signal from a specific remote device for local use. This programming is performed via the three settings shown above.

The **REMOTE INPUT 1 ID** setting allows the user to assign descriptive text to the remote input. The **REMOTE IN 1 DEVICE** setting selects the number (1 to 16) of the remote device which originates the required signal, as previously assigned to the remote device via the setting **REMOTE DEVICE *NN* ID** (see the *Remote Devices* section). **REMOTE IN 1 BIT PAIR** selects the specific bits of the GSSE/GOOSE message required.

The **REMOTE IN 1 DEFAULT STATE** setting selects the logic state for this point if the local relay has just completed startup or the remote device sending the point is declared to be non-communicating. The following choices are available:

- Setting **REMOTE IN 1 DEFAULT STATE** to “On” value defaults the input to Logic 1.
- Setting **REMOTE IN 1 DEFAULT STATE** to “Off” value defaults the input to Logic 0.
- Setting **REMOTE IN 1 DEFAULT STATE** to “Latest/On” freezes the input in case of lost communications. If the latest state is not known, such as after relay power-up but before the first communication exchange, the input will default to Logic 1. When communication resumes, the input becomes fully operational.
- Setting **REMOTE IN 1 DEFAULT STATE** to “Latest/Off” freezes the input in case of lost communications. If the latest state is not known, such as after relay power-up but before the first communication exchange, the input will default to Logic 0. When communication resumes, the input becomes fully operational.



NOTE For additional information on GSSE/GOOSE messaging, refer to the *Remote Devices* section in this chapter.

5.7.7 REMOTE OUTPUTS

a) DNA BIT PAIRS

PATH: SETTINGS ⇨ INPUTS/OUTPUTS ⇨ REMOTE OUTPUTS DNA BIT PAIRS ⇨ REMOTE OUPUTS DNA- 1(32) BIT PAIR

<input checked="" type="checkbox"/> REMOTE OUTPUTS <input checked="" type="checkbox"/> DNA- 1 BIT PAIR	◀▶ MESSAGE ▲	DNA- 1 OPERAND: Off	Range: FlexLogic™ operand
		DNA- 1 EVENTS: Disabled	Range: Disabled, Enabled

Remote outputs (1 to 32) are FlexLogic™ operands inserted into GSSE/GOOSE messages that are transmitted to remote devices on a LAN. Each digital point in the message must be programmed to carry the state of a specific FlexLogic™ operand. The above operand setting represents a specific DNA function (as shown in the following table) to be transmitted.

Table 5–23: IEC 61850 DNA ASSIGNMENTS

DNA	IEC 61850 DEFINITION	FLEXLOGIC™ OPERAND
1	Test	IEC 61850 TEST MODE
2	ConfRev	IEC 61850 CONF REV

b) USERST BIT PAIRS

PATH: SETTINGS ⇨ INPUTS/OUTPUTS ⇨ REMOTE OUTPUTS UserSt BIT PAIRS ⇨ REMOTE OUTPUTS UserSt- 1(32) BIT PAIR

<input checked="" type="checkbox"/> REMOTE OUTPUTS <input checked="" type="checkbox"/> UserSt- 1 BIT PAIR	◀▶ MESSAGE ▲	UserSt- 1 OPERAND: Off	Range: FlexLogic™ operand
		UserSt- 1 EVENTS: Disabled	Range: Disabled, Enabled

Remote outputs 1 to 32 originate as GSSE/GOOSE messages to be transmitted to remote devices. Each digital point in the message must be programmed to carry the state of a specific FlexLogic™ operand. The setting above is used to select the operand which represents a specific UserSt function (as selected by the user) to be transmitted.

The following setting represents the time between sending GSSE/GOOSE messages when there has been no change of state of any selected digital point. This setting is located in the **PRODUCT SETUP** ⇨ **COMMUNICATIONS** ⇨ **IEC 61850 PROTOCOL** ⇨ **GSSE/GOOSE CONFIGURATION** settings menu.

DEFAULT GSSE/GOOSE UPDATE TIME: 60 s	Range: 1 to 60 s in steps of 1
---	--------------------------------

The following setting determines whether remote input/output data is transported using IEC 61850 GSSE or IEC 61850 GOOSE messages. If GOOSE is selected, the VLAN and APPID settings should be set accordingly. If GSSE is selected, the VLAN and APPID settings are not relevant. This setting is located in the **PRODUCT SETUP** ⇨ **COMMUNICATIONS** ⇨ **IEC 61850 PROTOCOL** ⇨ **GSSE/GOOSE CONFIGURATION** menu.

REMOTE I/O TRANSFER METHOD: GSSE	Range: GOOSE, GSSE, None
-------------------------------------	--------------------------



For more information on GSSE/GOOSE messaging, refer to *Remote Inputs/Outputs Overview* in the *Remote Devices* section.

5.7.8 RESETTING

PATH: SETTINGS ⇨ INPUTS/OUTPUTS ⇨ RESETTING

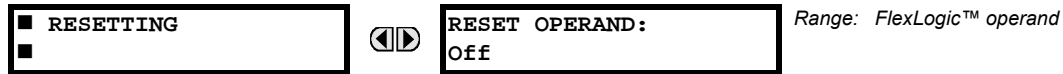

Some events can be programmed to latch the faceplate LED event indicators and the target message on the display. Once set, the latching mechanism will hold all of the latched indicators or messages in the set state after the initiating condition has cleared until a RESET command is received to return these latches (not including FlexLogic™ latches) to the reset state. The RESET command can be sent from the faceplate Reset button, a remote device via a communications channel, or any programmed operand.

When the RESET command is received by the relay, two FlexLogic™ operands are created. These operands, which are stored as events, reset the latches if the initiating condition has cleared. The three sources of RESET commands each create the RESET OP FlexLogic™ operand. Each individual source of a RESET command also creates its individual operand RESET OP (PUSHBUTTON), RESET OP (COMMS) or RESET OP (OPERAND) to identify the source of the command. The setting shown above selects the operand that will create the RESET OP (OPERAND) operand.

5.7.9 DIRECT INPUTS/OUTPUTS

a) DIRECT INPUTS

PATH: SETTINGS ⇨ INPUTS/OUTPUTS ⇨ DIRECT INPUTS ⇨ DIRECT INPUT 1(32)

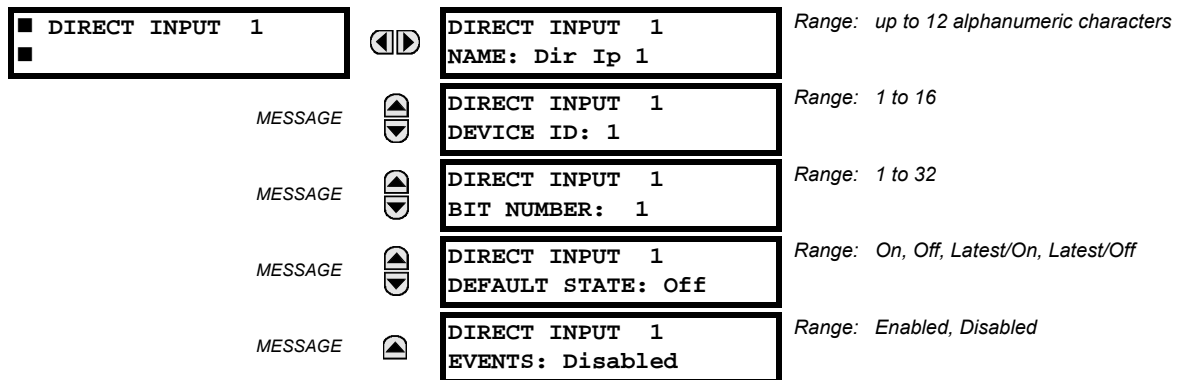

These settings specify how the direct input information is processed. The **DIRECT INPUT 1 NAME** setting allows the user to assign a descriptive name to the direct input. The **DIRECT INPUT 1 DEVICE ID** represents the source of this direct input. The specified direct input is driven by the device identified here.

The **DIRECT INPUT 1 BIT NUMBER** is the bit number to extract the state for this direct input. Direct Input x is driven by the bit identified here as **DIRECT INPUT 1 BIT NUMBER**. This corresponds to the direct output number of the sending device.

The **DIRECT INPUT 1 DEFAULT STATE** represents the state of the direct input when the associated direct device is offline. The following choices are available:

- Setting **DIRECT INPUT 1 DEFAULT STATE** to “On” value defaults the input to Logic 1.
- Setting **DIRECT INPUT 1 DEFAULT STATE** to “Off” value defaults the input to Logic 0.
- Setting **DIRECT INPUT 1 DEFAULT STATE** to “Latest/On” freezes the input in case of lost communications. If the latest state is not known, such as after relay power-up but before the first communication exchange, the input will default to Logic 1. When communication resumes, the input becomes fully operational.
- Setting **DIRECT INPUT 1 DEFAULT STATE** to “Latest/Off” freezes the input in case of lost communications. If the latest state is not known, such as after relay power-up but before the first communication exchange, the input will default to Logic 0. When communication resumes, the input becomes fully operational.

b) DIRECT OUTPUTS

PATH: SETTINGS ⇒ INPUTS/OUTPUTS ⇒ DIRECT OUTPUTS ⇒ DIRECT OUTPUT 1(32)

<input type="checkbox"/> DIRECT OUTPUT 1 <input type="checkbox"/>		DIRECT OUT 1 NAME: Dir Out 1	<i>Range: up to 12 alphanumeric characters</i>
MESSAGE		DIRECT OUT 1 OPERAND: Off	<i>Range: FlexLogic™ operand</i>
MESSAGE		DIRECT OUTPUT 1 EVENTS: Disabled	<i>Range: Enabled, Disabled</i>

The **DIRECT OUT 1 NAME** setting allows the user to assign a descriptive name to the direct output. The **DIR OUT 1 OPERAND** is the FlexLogic™ operand that determines the state of this direct output.

c) APPLICATION EXAMPLES

The examples introduced in the earlier *Direct Inputs/Outputs* section (part of the *Product Setup* section) direct inputs/outputs are continued below to illustrate usage of the direct inputs and outputs.

EXAMPLE 1: EXTENDING INPUT/OUTPUT CAPABILITIES OF A T60 RELAY

Consider an application that requires additional quantities of digital inputs and/or output contacts and/or lines of programmable logic that exceed the capabilities of a single UR-series chassis. The problem is solved by adding an extra UR-series IED, such as the C30, to satisfy the additional inputs/outputs and programmable logic requirements. The two IEDs are connected via single-channel digital communication cards as shown below.

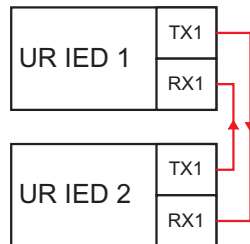

Figure 5–83: INPUT/OUTPUT EXTENSION VIA DIRECT INPUTS/OUTPUTS

Assume Contact Input 1 from UR IED 2 is to be used by UR IED 1. The following settings should be applied (Direct Input 5 and bit number 12 are used, as an example):

UR IED 1: **DIRECT INPUT 5 DEVICE ID = "2"**
DIRECT INPUT 5 BIT NUMBER = "12"

UR IED 2: **DIRECT OUT 12 OPERAND = "Cont Ip 1 On"**

The Cont Ip 1 On operand of UR IED 2 is now available in UR IED 1 as DIRECT INPUT 5 ON.

EXAMPLE 2: INTERLOCKING BUSBAR PROTECTION

A simple interlocking busbar protection scheme can be accomplished by sending a blocking signal from downstream devices, say 2, 3 and 4, to the upstream device that monitors a single incomer of the busbar, as shown in the figure below.

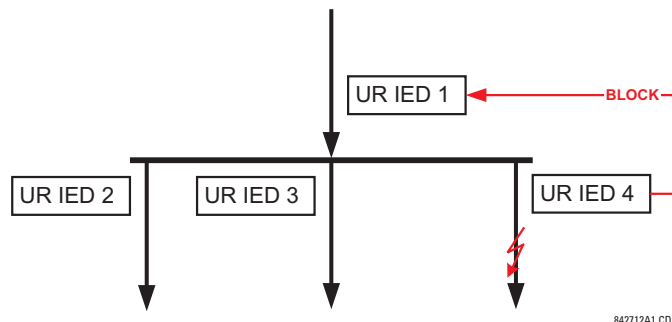

Figure 5–84: SAMPLE INTERLOCKING BUSBAR PROTECTION SCHEME

Assume that Phase Instantaneous Overcurrent 1 is used by Devices 2, 3, and 4 to block Device 1. If not blocked, Device 1 would trip the bus upon detecting a fault and applying a short coordination time delay.

The following settings should be applied (assume Bit 3 is used by all 3 devices to sent the blocking signal and Direct Inputs 7, 8, and 9 are used by the receiving device to monitor the three blocking signals):

UR IED 2: **DIRECT OUT 3 OPERAND:** "PHASE IOC1 OP"

UR IED 3: **DIRECT OUT 3 OPERAND:** "PHASE IOC1 OP"

UR IED 4: **DIRECT OUT 3 OPERAND:** "PHASE IOC1 OP"

UR IED 1: **DIRECT INPUT 7 DEVICE ID:** "2"
DIRECT INPUT 7 BIT NUMBER: "3"
DIRECT INPUT 7 DEFAULT STATE: select "On" for security, select "Off" for dependability

DIRECT INPUT 8 DEVICE ID: "3"
DIRECT INPUT 8 BIT NUMBER: "3"
DIRECT INPUT 8 DEFAULT STATE: select "On" for security, select "Off" for dependability

DIRECT INPUT 9 DEVICE ID: "4"
DIRECT INPUT 9 BIT NUMBER: "3"
DIRECT INPUT 9 DEFAULT STATE: select "On" for security, select "Off" for dependability

Now the three blocking signals are available in UR IED 1 as DIRECT INPUT 7 ON, DIRECT INPUT 8 ON, and DIRECT INPUT 9 ON. Upon losing communications or a device, the scheme is inclined to block (if any default state is set to "On"), or to trip the bus on any overcurrent condition (all default states set to "Off").

EXAMPLE 2: PILOT-AIDED SCHEMES

Consider a three-terminal line protection application shown in the figure below.

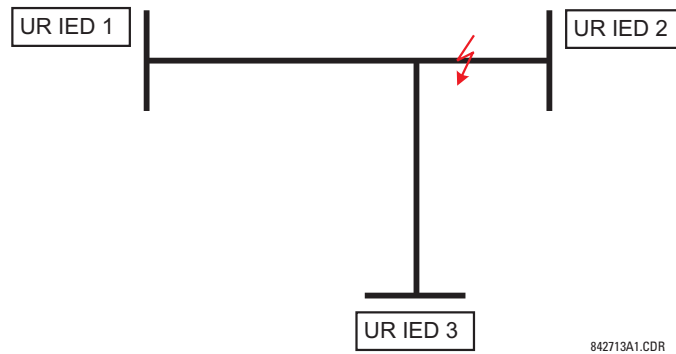

Figure 5–85: THREE-TERMINAL LINE APPLICATION

Assume the Hybrid Permissive Overreaching Transfer Trip (Hybrid POTT) scheme is applied using the architecture shown below. The scheme output operand HYB POTT TX1 is used to key the permission.

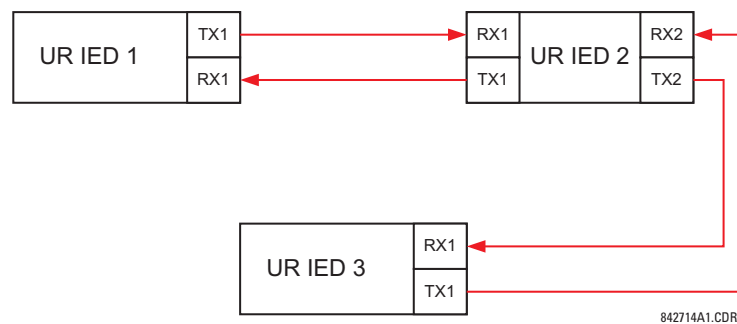

Figure 5–86: SINGLE-CHANNEL OPEN-LOOP CONFIGURATION

In the above architecture, Devices 1 and 3 do not communicate directly. Therefore, Device 2 must act as a 'bridge'. The following settings should be applied:

- UR IED 1: **DIRECT OUT 2 OPERAND:** "HYB POTT TX1"
DIRECT INPUT 5 DEVICE ID: "2"
DIRECT INPUT 5 BIT NUMBER: "2" (this is a message from IED 2)
DIRECT INPUT 6 DEVICE ID: "2"
DIRECT INPUT 6 BIT NUMBER: "4" (effectively, this is a message from IED 3)
- UR IED 3: **DIRECT OUT 2 OPERAND:** "HYB POTT TX1"
DIRECT INPUT 5 DEVICE ID: "2"
DIRECT INPUT 5 BIT NUMBER: "2" (this is a message from IED 2)
DIRECT INPUT 6 DEVICE ID: "2"
DIRECT INPUT 6 BIT NUMBER: "3" (effectively, this is a message from IED 1)
- UR IED 2: **DIRECT INPUT 5 DEVICE ID:** "1"
DIRECT INPUT 5 BIT NUMBER: "2"
DIRECT INPUT 6 DEVICE ID: "3"
DIRECT INPUT 6 BIT NUMBER: "2"
DIRECT OUT 2 OPERAND: "HYB POTT TX1"
DIRECT OUT 3 OPERAND: "DIRECT INPUT 5" (forward a message from 1 to 3)
DIRECT OUT 4 OPERAND: "DIRECT INPUT 6" (forward a message from 3 to 1)

Signal flow between the three IEDs is shown in the figure below:

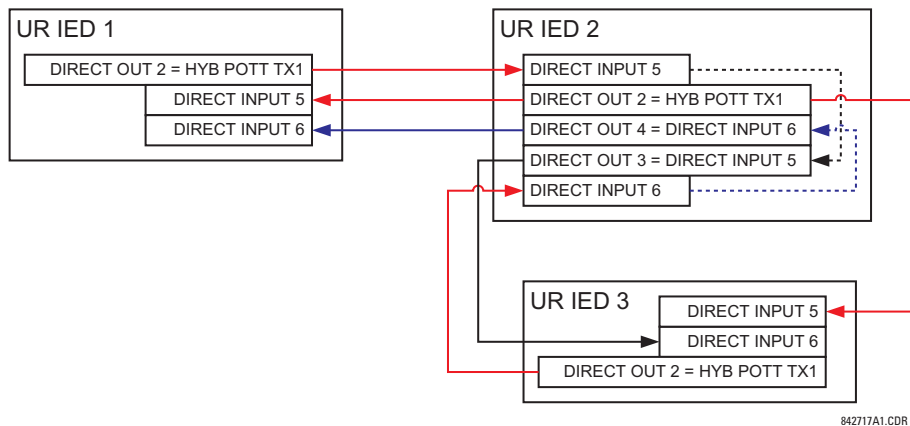

Figure 5–87: SIGNAL FLOW FOR DIRECT INPUT/OUTPUT EXAMPLE 3

In three-terminal applications, both the remote terminals must grant permission to trip. Therefore, at each terminal, Direct Inputs 5 and 6 should be ANDed in FlexLogic™ and the resulting operand configured as the permission to trip (HYB POTT RX1 setting).

5.7.10 TELEPROTECTION INPUTS/OUTPUTS

a) OVERVIEW

The relay provides sixteen teleprotection inputs on communications channel 1 (numbered 1-1 through 1-16) and sixteen teleprotection inputs on communications channel 2 (on two-terminals two-channel and three-terminal systems only, numbered 2-1 through 2-16). The remote relay connected to channels 1 and 2 of the local relay is programmed by assigning FlexLogic™ operands to be sent via the selected communications channel. This allows the user to create distributed protection and control schemes via dedicated communications channels. Some examples are directional comparison pilot schemes and direct transfer tripping. It should be noted that failures of communications channels will affect teleprotection functionality. The teleprotection function must be enabled to utilize the inputs.

b) TELEPROTECTION INPUTS

PATH: SETTINGS ⇒ INPUTS/OUTPUTS ⇒ TELEPROTECTION ⇒ TELEPROT INPUTS

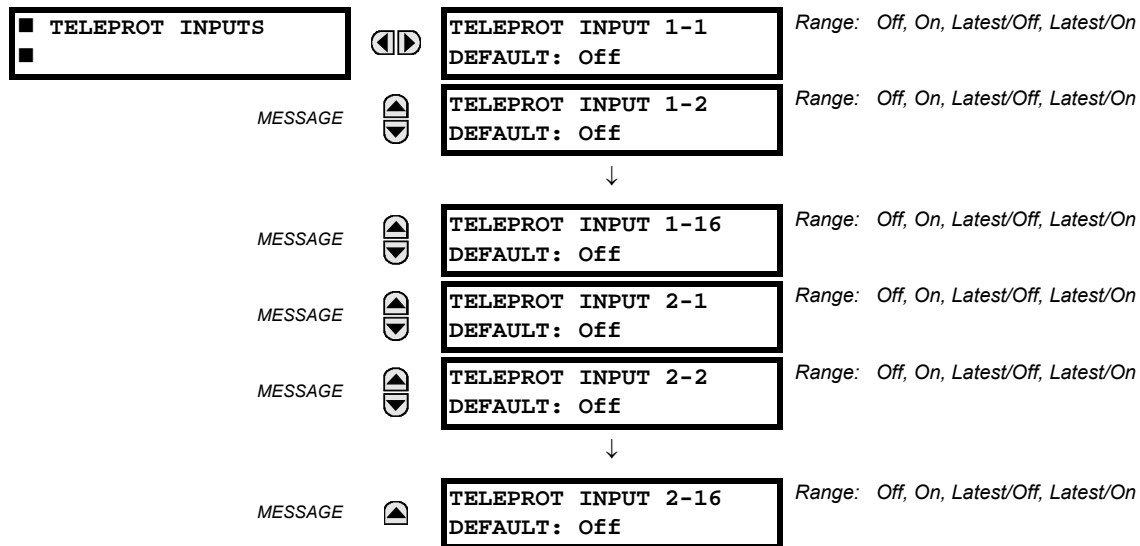

Setting the **TELEPROT INPUT ~- DEFAULT** setting to “On” defaults the input to logic 1 when the channel fails. A value of “Off” defaults the input to logic 0 when the channel fails.

The “Latest/On” and “Latest/Off” values freeze the input in case of lost communications. If the latest state is not known, such as after relay power-up but before the first communication exchange, then the input defaults to logic 1 for “Latest/On” and logic 0 for “Latest/Off”.

c) TELEPROTECTION OUTPUTS

PATH: SETTINGS ⇌ INPUTS/OUTPUTS ⇌ TELEPROTECTION ⇌ TELEPROT OUTPUTS

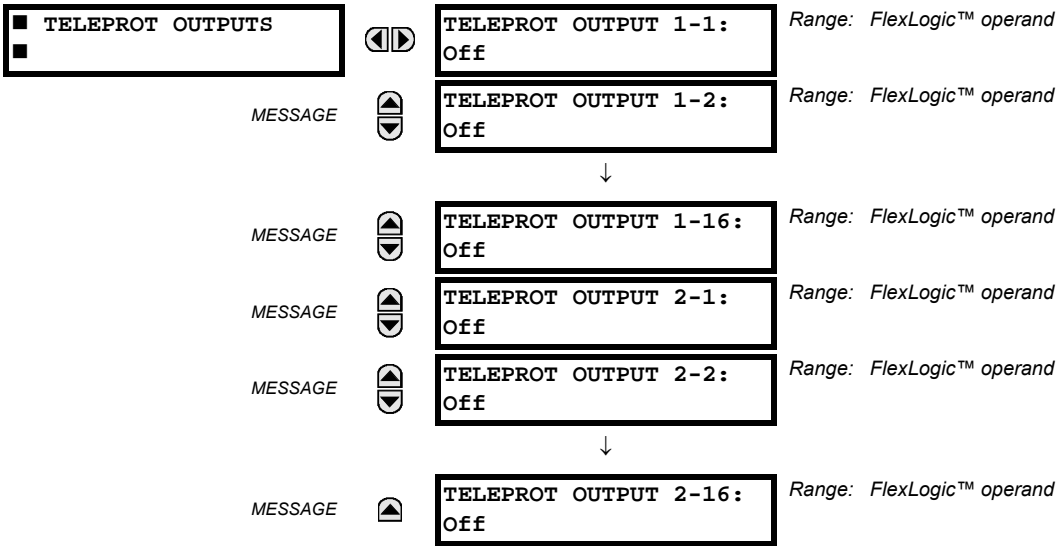

As the following figure demonstrates, processing of the teleprotection inputs/outputs is dependent on the number of communication channels and terminals. On two-terminal two-channel systems, they are processed continuously on each channel and mapped separately per channel. Therefore, to achieve redundancy, the user must assign the same operand on both channels (teleprotection outputs at the sending end or corresponding teleprotection inputs at the receiving end). On three-terminal two-channel systems, redundancy is achieved by programming signal re-transmittal in the case of channel failure between any pair of relays.

5

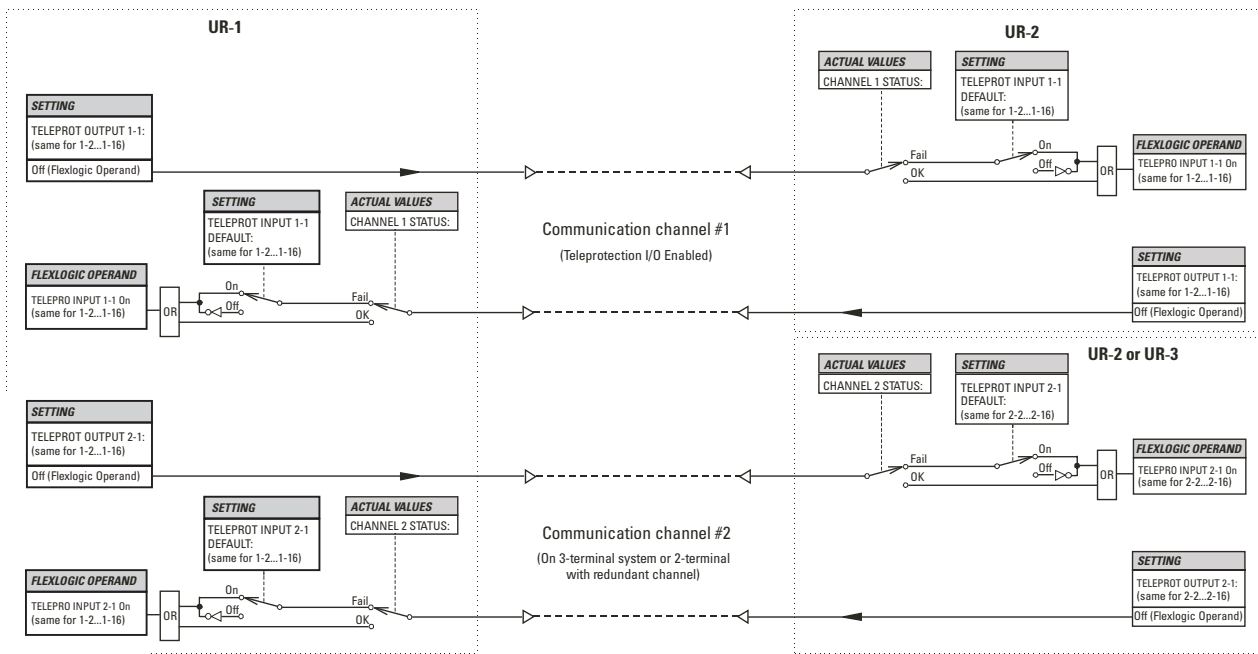

842750A2.CDR

Figure 5-88: TELEPROTECTION INPUT/OUTPUT PROCESSING

5.8.1 DCMA INPUTS

PATH: SETTINGS ⇨ ⇩ TRANSDUCER I/O ⇨ ⇩ DCMA INPUTS ⇨ DCMA INPUT F1(W8)

■ DCMA INPUT F1	◀▶	DCMA INPUT F1 FUNCTION: Disabled	Range: Disabled, Enabled
MESSAGE	▲▼	DCMA INPUT F1 ID: DCMA Ip 1	Range: up to 20 alphanumeric characters
MESSAGE	▲▼	DCMA INPUT F1 UNITS: μ A	Range: 6 alphanumeric characters
MESSAGE	▲▼	DCMA INPUT F1 RANGE: 0 to -1 mA	Range: 0 to -1 mA, 0 to +1 mA, -1 to +1 mA, 0 to 5 mA, 0 to 10mA, 0 to 20 mA, 4 to 20 mA
MESSAGE	▲▼	DCMA INPUT F1 MIN VALUE: 0.000	Range: -9999.999 to +9999.999 in steps of 0.001
MESSAGE	▲	DCMA INPUT F1 MAX VALUE: 0.000	Range: -9999.999 to +9999.999 in steps of 0.001

Hardware and software is provided to receive signals from external transducers and convert these signals into a digital format for use as required. The relay will accept inputs in the range of -1 to +20 mA DC, suitable for use with most common transducer output ranges; all inputs are assumed to be linear over the complete range. Specific hardware details are contained in Chapter 3.

Before the dcmA input signal can be used, the value of the signal measured by the relay must be converted to the range and quantity of the external transducer primary input parameter, such as DC voltage or temperature. The relay simplifies this process by internally scaling the output from the external transducer and displaying the actual primary parameter.

dcmA input channels are arranged in a manner similar to CT and VT channels. The user configures individual channels with the settings shown here.

The channels are arranged in sub-modules of two channels, numbered from 1 through 8 from top to bottom. On power-up, the relay will automatically generate configuration settings for every channel, based on the order code, in the same general manner that is used for CTs and VTs. Each channel is assigned a slot letter followed by the row number, 1 through 8 inclusive, which is used as the channel number. The relay generates an actual value for each available input channel.

Settings are automatically generated for every channel available in the specific relay as shown above for the first channel of a type 5F transducer module installed in slot F.

The function of the channel may be either "Enabled" or "Disabled". If "Disabled", no actual values are created for the channel. An alphanumeric "ID" is assigned to each channel; this ID will be included in the channel actual value, along with the programmed units associated with the parameter measured by the transducer, such as volts, °C, megawatts, etc. This ID is also used to reference the channel as the input parameter to features designed to measure this type of parameter. The **DCMA INPUT F1 RANGE** setting specifies the mA DC range of the transducer connected to the input channel.

The **DCMA INPUT F1 MIN VALUE** and **DCMA INPUT F1 MAX VALUE** settings are used to program the span of the transducer in primary units. For example, a temperature transducer might have a span from 0 to 250°C; in this case the **DCMA INPUT F1 MIN VALUE** value is "0" and the **DCMA INPUT F1 MAX VALUE** value is "250". Another example would be a watts transducer with a span from -20 to +180 MW; in this case the **DCMA INPUT F1 MIN VALUE** value would be "-20" and the **DCMA INPUT F1 MAX VALUE** value "180". Intermediate values between the min and max values are scaled linearly.

5.8.2 RTD INPUTS

PATH: SETTINGS ⇌ TRANSDUCER I/O ⇌ RTD INPUTS ⇌ RTD INPUT F1(W8)

■ RTD INPUT F1	◀▶	RTD INPUT F1 FUNCTION: Disabled	Range: Disabled, Enabled
MESSAGE	▲▼	RTD INPUT F1 ID: RTD Ip 1	Range: Up to 20 alphanumeric characters
MESSAGE	▲	RTD INPUT F1 TYPE: 100Ω Nickel	Range: 100Ω Nickel, 10Ω Copper, 100Ω Platinum, 120Ω Nickel

Hardware and software is provided to receive signals from external resistance temperature detectors and convert these signals into a digital format for use as required. These channels are intended to be connected to any of the RTD types in common use. Specific hardware details are contained in Chapter 3.

RTD input channels are arranged in a manner similar to CT and VT channels. The user configures individual channels with the settings shown here.

The channels are arranged in sub-modules of two channels, numbered from 1 through 8 from top to bottom. On power-up, the relay will automatically generate configuration settings for every channel, based on the order code, in the same general manner that is used for CTs and VTs. Each channel is assigned a slot letter followed by the row number, 1 through 8 inclusive, which is used as the channel number. The relay generates an actual value for each available input channel.

Settings are automatically generated for every channel available in the specific relay as shown above for the first channel of a type 5C transducer module installed in slot F.

The function of the channel may be either “Enabled” or “Disabled”. If “Disabled”, there will not be an actual value created for the channel. An alphanumeric ID is assigned to the channel; this ID will be included in the channel actual values. It is also used to reference the channel as the input parameter to features designed to measure this type of parameter. Selecting the type of RTD connected to the channel configures the channel.

Actions based on RTD overtemperature, such as trips or alarms, are done in conjunction with the FlexElements™ feature. In FlexElements™, the operate level is scaled to a base of 100°C. For example, a trip level of 150°C is achieved by setting the operate level at 1.5 pu. FlexElement™ operands are available to FlexLogic™ for further interlocking or to operate an output contact directly.

5.8.3 DCMA OUTPUTS

PATH: SETTINGS ⇌ TRANSDUCER I/O ⇌ DCMA OUTPUTS ⇌ DCMA OUTPUT F1(W8)

■ DCMA OUTPUT F1	◀▶	DCMA OUTPUT F1 SOURCE: Off	Range: Off, any analog actual value parameter
MESSAGE	▲▼	DCMA OUTPUT F1 RANGE: -1 to 1 mA	Range: -1 to 1 mA, 0 to 1 mA, 4 to 20 mA
MESSAGE	▲▼	DCMA OUTPUT F1 MIN VAL: 0.000 pu	Range: -90.000 to 90.000 pu in steps of 0.001
MESSAGE	▲	DCMA OUTPUT F1 MAX VAL: 1.000 pu	Range: -90.000 to 90.000 pu in steps of 0.001

Hardware and software is provided to generate dcmA signals that allow interfacing with external equipment. Specific hardware details are contained in Chapter 3. The dcmA output channels are arranged in a manner similar to transducer input or CT and VT channels. The user configures individual channels with the settings shown below.

The channels are arranged in sub-modules of two channels, numbered 1 through 8 from top to bottom. On power-up, the relay automatically generates configuration settings for every channel, based on the order code, in the same manner used for CTs and VTs. Each channel is assigned a slot letter followed by the row number, 1 through 8 inclusive, which is used as the channel number.

Both the output range and a signal driving a given output are user-programmable via the following settings menu (an example for channel M5 is shown).

The relay checks the driving signal (x in equations below) for the minimum and maximum limits, and subsequently re-scales so the limits defined as **MIN VAL** and **MAX VAL** match the output range of the hardware defined as **RANGE**. The following equation is applied:

$$I_{out} = \begin{cases} I_{min} & \text{if } x < \text{MIN VAL} \\ I_{max} & \text{if } x > \text{MAX VAL} \\ k(x - \text{MIN VAL}) + I_{min} & \text{otherwise} \end{cases} \quad (\text{EQ 5.47})$$

where: x is a driving signal specified by the **SOURCE** setting

I_{min} and I_{max} are defined by the **RANGE** setting

k is a scaling constant calculated as:

$$k = \frac{I_{max} - I_{min}}{\text{MAX VAL} - \text{MIN VAL}} \quad (\text{EQ 5.48})$$

The feature is intentionally inhibited if the **MAX VAL** and **MIN VAL** settings are entered incorrectly, e.g. when **MAX VAL** – **MIN VAL** < 0.1 pu. The resulting characteristic is illustrated in the following figure.

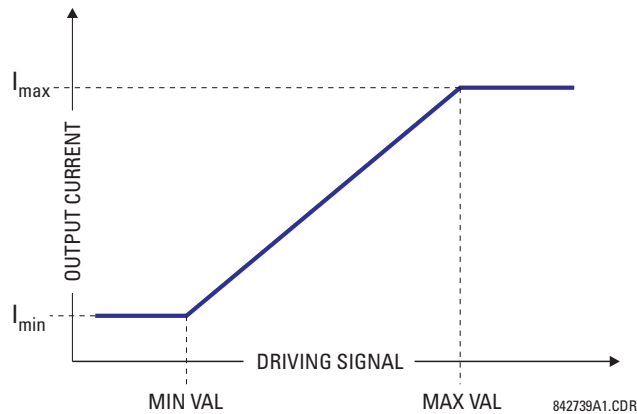

Figure 5–89: DCMA OUTPUT CHARACTERISTIC

The dcmA output settings are described below.

- **DCMA OUTPUT F1 SOURCE:** This setting specifies an internal analog value to drive the analog output. Actual values (FlexAnalog parameters) such as power, current amplitude, voltage amplitude, power factor, etc. can be configured as sources driving dcmA outputs. Refer to Appendix A for a complete list of FlexAnalog parameters.
- **DCMA OUTPUT F1 RANGE:** This setting allows selection of the output range. Each dcmA channel may be set independently to work with different ranges. The three most commonly used output ranges are available.
- **DCMA OUTPUT F1 MIN VAL:** This setting allows setting the minimum limit for the signal that drives the output. This setting is used to control the mapping between an internal analog value and the output current (see the following examples). The setting is entered in per-unit values. The base units are defined in the same manner as the FlexElement™ base units.
- **DCMA OUTPUT F1 MAX VAL:** This setting allows setting the maximum limit for the signal that drives the output. This setting is used to control the mapping between an internal analog value and the output current (see the following examples). The setting is entered in per-unit values. The base units are defined in the same manner as the FlexElement™ base units.

Three application examples are described below.

EXAMPLE 1:

A three phase active power on a 13.8 kV system measured via UR-series relay source 1 is to be monitored by the dcmA H1 output of the range of –1 to 1 mA. The following settings are applied on the relay: CT ratio = 1200:5, VT secondary 115, VT connection is delta, and VT ratio = 120. The nominal current is 800 A primary and the nominal power factor is 0.90. The power is to be monitored in both importing and exporting directions and allow for 20% overload compared to the nominal.

The nominal three-phase power is:

$$P = \sqrt{3} \times 13.8 \text{ kV} \times 0.8 \text{ kA} \times 0.9 = 17.21 \text{ MW} \quad (\text{EQ 5.49})$$

The three-phase power with 20% overload margin is:

$$P_{max} = 1.2 \times 17.21 \text{ MW} = 20.65 \text{ MW} \quad (\text{EQ 5.50})$$

The base unit for power (refer to the FlexElements section in this chapter for additional details) is:

$$P_{BASE} = 115 \text{ V} \times 120 \times 1.2 \text{ kA} = 16.56 \text{ MW} \quad (\text{EQ 5.51})$$

The minimum and maximum power values to be monitored (in pu) are:

$$\text{minimum power} = \frac{-20.65 \text{ MW}}{16.56 \text{ MW}} = -1.247 \text{ pu}, \quad \text{maximum power} = \frac{20.65 \text{ MW}}{16.56 \text{ MW}} = 1.247 \text{ pu} \quad (\text{EQ 5.52})$$

The following settings should be entered:

DCMA OUTPUT H1 SOURCE: "SRC 1 P"
DCMA OUTPUT H1 RANGE: "-1 to 1 mA"
DCMA OUTPUT H1 MIN VAL: "-1.247 pu"
DCMA OUTPUT H1 MAX VAL: "1.247 pu"

With the above settings, the output will represent the power with the scale of 1 mA per 20.65 MW. The worst-case error for this application can be calculated by superimposing the following two sources of error:

- $\pm 0.5\%$ of the full scale for the analog output module, or $\pm 0.005 \times (1 - (-1)) \times 20.65 \text{ MW} = \pm 0.207 \text{ MW}$
- $\pm 1\%$ of reading error for the active power at power factor of 0.9

For example at the reading of 20 MW, the worst-case error is $0.01 \times 20 \text{ MW} + 0.207 \text{ MW} = 0.407 \text{ MW}$.

EXAMPLE 2:

The phase A current (true RMS value) is to be monitored via the H2 current output working with the range from 4 to 20 mA. The CT ratio is 5000:5 and the maximum load current is 4200 A. The current should be monitored from 0 A upwards, allowing for 50% overload.

The phase current with the 50% overload margin is:

$$I_{max} = 1.5 \times 4.2 \text{ kA} = 6.3 \text{ kA} \quad (\text{EQ 5.53})$$

The base unit for current (refer to the FlexElements section in this chapter for additional details) is:

$$I_{BASE} = 5 \text{ kA} \quad (\text{EQ 5.54})$$

The minimum and maximum power values to be monitored (in pu) are:

$$\text{minimum current} = \frac{0 \text{ kA}}{5 \text{ kA}} = 0 \text{ pu}, \quad \text{maximum current} = \frac{6.3 \text{ kA}}{5 \text{ kA}} = 1.26 \text{ pu} \quad (\text{EQ 5.55})$$

The following settings should be entered:

DCMA OUTPUT H2 SOURCE: "SRC 1 Ia RMS"
DCMA OUTPUT H2 RANGE: "4 to 20 mA"
DCMA OUTPUT H2 MIN VAL: "0.000 pu"
DCMA OUTPUT H2 MAX VAL: "1.260 pu"

The worst-case error for this application could be calculated by superimposing the following two sources of error:

- $\pm 0.5\%$ of the full scale for the analog output module, or $\pm 0.005 \times (20 - 4) \times 6.3 \text{ kA} = \pm 0.504 \text{ kA}$
- $\pm 0.25\%$ of reading or $\pm 0.1\%$ of rated (whichever is greater) for currents between 0.1 and 2.0 of nominal

For example, at the reading of 4.2 kA, the worst-case error is $\max(0.0025 \times 4.2 \text{ kA}, 0.001 \times 5 \text{ kA}) + 0.504 \text{ kA} = 0.515 \text{ kA}$.

EXAMPLE 3:

A positive-sequence voltage on a 400 kV system measured via Source 2 is to be monitored by the dcma H3 output with a range of 0 to 1 mA. The VT secondary setting is 66.4 V, the VT ratio setting is 6024, and the VT connection setting is "Delta". The voltage should be monitored in the range from 70% to 110% of nominal.

The minimum and maximum positive-sequence voltages to be monitored are:

$$V_{min} = 0.7 \times \frac{400 \text{ kV}}{\sqrt{3}} = 161.66 \text{ kV}, \quad V_{max} = 1.1 \times \frac{400 \text{ kV}}{\sqrt{3}} = 254.03 \text{ kV} \quad (\text{EQ 5.56})$$

The base unit for voltage (refer to the FlexElements section in this chapter for additional details) is:

$$V_{BASE} = 0.0664 \text{ kV} \times 6024 = 400 \text{ kV} \quad (\text{EQ 5.57})$$

The minimum and maximum voltage values to be monitored (in pu) are:

$$\text{minimum voltage} = \frac{161.66 \text{ kV}}{400 \text{ kV}} = 0.404 \text{ pu}, \quad \text{maximum voltage} = \frac{254.03 \text{ kV}}{400 \text{ kV}} = 0.635 \text{ pu} \quad (\text{EQ 5.58})$$

The following settings should be entered:

DCMA OUTPUT H3 SOURCE: "SRC 2 V_1 mag"
DCMA OUTPUT H3 RANGE: "0 to 1 mA"
DCMA OUTPUT H3 MIN VAL: "0.404 pu"
DCMA OUTPUT H3 MAX VAL: "0.635 pu"

The limit settings differ from the expected 0.7 pu and 1.1 pu because the relay calculates the positive-sequence quantities scaled to the phase-to-ground voltages, even if the VTs are connected in "Delta" (refer to the *Metering Conventions* section in Chapter 6), while at the same time the VT nominal voltage is 1 pu for the settings. Consequently the settings required in this example differ from naturally expected by the factor of $\sqrt{3}$.

The worst-case error for this application could be calculated by superimposing the following two sources of error:

- $\pm 0.5\%$ of the full scale for the analog output module, or $\pm 0.005 \times (1 - 0) \times 254.03 \text{ kV} = \pm 1.27 \text{ kV}$
- $\pm 0.5\%$ of reading

For example, under nominal conditions, the positive-sequence reads 230.94 kV and the worst-case error is $0.005 \times 230.94 \text{ kV} + 1.27 \text{ kV} = 2.42 \text{ kV}$.

5.9.1 TEST MODE

PATH: SETTINGS ⇌ TESTING ⇌ TEST MODE

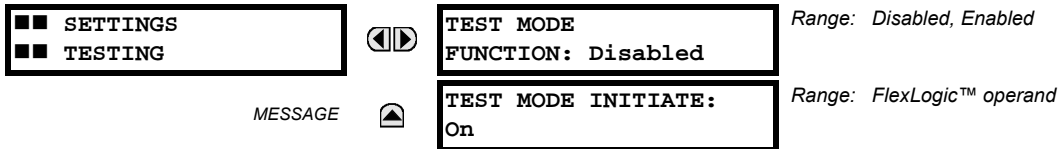

The relay provides test settings to verify that functionality using simulated conditions for contact inputs and outputs. The Test Mode is indicated on the relay faceplate by a flashing Test Mode LED indicator.

To initiate the Test mode, the **TEST MODE FUNCTION** setting must be “Enabled” and the **TEST MODE INITIATE** setting must be set to Logic 1. In particular:

- To initiate Test Mode through relay settings, set **TEST MODE INITIATE** to “On”. The Test Mode starts when the **TEST MODE FUNCTION** setting is changed from “Disabled” to “Enabled”.
- To initiate Test Mode through a user-programmable condition, such as FlexLogic™ operand (pushbutton, digital input, communication-based input, or a combination of these), set **TEST MODE FUNCTION** to “Enabled” and set **TEST MODE INITIATE** to the desired operand. The Test Mode starts when the selected operand assumes a Logic 1 state.

When in Test Mode, the T60 remains fully operational, allowing for various testing procedures. In particular, the protection and control elements, FlexLogic™, and communication-based inputs and outputs function normally.

The only difference between the normal operation and the Test Mode is the behavior of the input and output contacts. The former can be forced to report as open or closed or remain fully operational; the latter can be forced to open, close, freeze, or remain fully operational. The response of the digital input and output contacts to the Test Mode is programmed individually for each input and output using the Force Contact Inputs and Force Contact Outputs test functions described in the following sections.

5.9.2 FORCE CONTACT INPUTS

PATH: SETTINGS ⇌ TESTING ⇌ FORCE CONTACT INPUTS

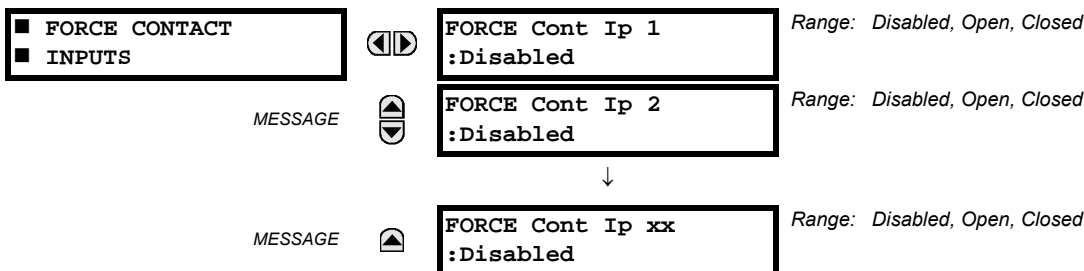

The relay digital inputs (contact inputs) could be pre-programmed to respond to the Test Mode in the following ways:

- If set to “Disabled”, the input remains fully operational. It is controlled by the voltage across its input terminals and can be turned on and off by external circuitry. This value should be selected if a given input must be operational during the test. This includes, for example, an input initiating the test, or being a part of a user pre-programmed test sequence.
- If set to “Open”, the input is forced to report as opened (Logic 0) for the entire duration of the Test Mode regardless of the voltage across the input terminals.
- If set to “Closed”, the input is forced to report as closed (Logic 1) for the entire duration of the Test Mode regardless of the voltage across the input terminals.

The Force Contact Inputs feature provides a method of performing checks on the function of all contact inputs. Once enabled, the relay is placed into Test Mode, allowing this feature to override the normal function of contact inputs. The Test Mode LED will be On, indicating that the relay is in Test Mode. The state of each contact input may be programmed as “Disabled”, “Open”, or “Closed”. All contact input operations return to normal when all settings for this feature are disabled.

5.9.3 FORCE CONTACT OUTPUTS

PATH: SETTINGS ⇒ TESTING ⇒ FORCE CONTACT OUTPUTS

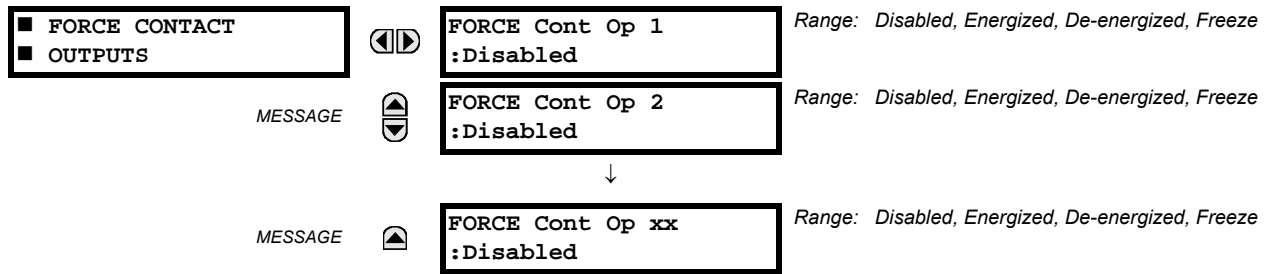

The relay contact outputs can be pre-programmed to respond to the Test Mode.

If set to “Disabled”, the contact output remains fully operational. If operates when its control operand is Logic 1 and will reset when its control operand is Logic 0. If set to “Energize”, the output will close and remain closed for the entire duration of the Test Mode, regardless of the status of the operand configured to control the output contact. If set to “De-energize”, the output will open and remain opened for the entire duration of the Test Mode regardless of the status of the operand configured to control the output contact. If set to “Freeze”, the output retains its position from before entering the Test Mode, regardless of the status of the operand configured to control the output contact.

These settings are applied two ways. First, external circuits may be tested by energizing or de-energizing contacts. Second, by controlling the output contact state, relay logic may be tested and undesirable effects on external circuits avoided.

Example 1: Initiating a Test from User-Programmable Pushbutton 1

The Test Mode should be initiated from User-Programmable Pushbutton 1. The pushbutton will be programmed as “Latched” (pushbutton pressed to initiate the test, and pressed again to terminate the test). During the test, Digital Input 1 should remain operational, Digital Inputs 2 and 3 should open, and Digital Input 4 should close. Also, Contact Output 1 should freeze, Contact Output 2 should open, Contact Output 3 should close, and Contact Output 4 should remain fully operational. The required settings are shown below.

To enable User-Programmable Pushbutton 1 to initiate the Test mode, make the following changes in the **SETTINGS** ⇒ **TESTING** ⇒ **TEST MODE** menu:

TEST MODE FUNCTION: “Enabled” and **TEST MODE INITIATE:** “PUSHBUTTON 1 ON”

Make the following changes to configure the Contact I/Os. In the **SETTINGS** ⇒ **TESTING** ⇒ **FORCE CONTACT INPUTS** and **FORCE CONTACT OUTPUTS** menus, set:

FORCE Cont Ip 1: “Disabled”, **FORCE Cont Ip 2:** “Open”, **FORCE Cont Ip 3:** “Open”, and **FORCE Cont Ip 4:** “Closed”

FORCE Cont Op 1: “Freeze”, **FORCE Cont Op 2:** “De-energized”, **FORCE Cont Op 3:** “Open”, and **FORCE Cont Op 4:** “Disabled”

Example 2: Initiating a Test from User-Programmable Pushbutton 1 or through Remote Input 1

The Test should be initiated locally from User-Programmable Pushbutton 1 or remotely through Remote Input 1. Both the pushbutton and the remote input will be programmed as “Latched”. The required settings are shown below.

Write the following FlexLogic™ equation (EnerVista UR Setup example shown):

FLEXLOGIC ENTRY	TYPE	SYNTAX
View Graphic	View	View
FlexLogic Entry 1	Remote Inputs On	Remote I/P 1 ON
FlexLogic Entry 2	Protection Element	PUSHBUTTON 1 ON
FlexLogic Entry 3	OR	2 Input
FlexLogic Entry 4	Write Virtual Output[Assign]	= Virt Op 1 (VO1)
FlexLogic Entry 5	End of List	

Set the User Programmable Pushbutton as latching by changing **SETTINGS** ⇒ **PRODUCT SETUP** ⇒ **USER-PROGRAMMABLE PUSHBUTTONS** ⇒ **USER PUSHBUTTON 1** ⇒ **PUSHBUTTON 1 FUNCTION** to “Latched”. To enable either Pushbutton 1 or Remote Input 1 to initiate the Test mode, make the following changes in the **SETTINGS** ⇒ **TESTING** ⇒ **TEST MODE** menu:

TEST MODE FUNCTION: “Enabled” and **TEST MODE INITIATE:** “VO1”

6.1.1 ACTUAL VALUES MAIN MENU

■ ■ ACTUAL VALUES
■ ■ STATUS



■ CONTACT INPUTS
■

See page 6-3.

■ VIRTUAL INPUTS
■

See page 6-3.

■ REMOTE INPUTS
■

See page 6-3.

■ TELEPROTECTION
■ INPUTS

See page 6-4.

■ CONTACT OUTPUTS
■

See page 6-4.

■ VIRTUAL OUTPUTS
■

See page 6-4.

■ REMOTE DEVICES
■ STATUS

See page 6-5.

■ REMOTE DEVICES
■ STATISTICS

See page 6-5.

■ DIGITAL COUNTERS
■

See page 6-5.

■ SELECTOR SWITCHES
■

See page 6-6.

■ FLEX STATES
■

See page 6-6.

■ ETHERNET
■

See page 6-6.

■ DIRECT INPUTS
■

See page 6-7.

■ DIRECT DEVICES
■ STATUS

See page 6-7.

■ EGD PROTOCOL
■ STATUS

See page 6-8.

■ TELEPROT CH TESTS
■

See page 6-8.

■ ■ ACTUAL VALUES
■ ■ METERING



■ TRANSFORMER
■

See page 6-12.

■ SOURCE SRC 1
■

See page 6-13.

■ SOURCE SRC 2
■

■ SOURCE SRC 3
■

▲	■ SOURCE SRC 4 ■	
▲▼	■ TRACKING FREQUENCY ■	See page 6-17.
▲▼	■ FLEXELEMENTS ■	See page 6-17.
▲▼	■ VOLTS PER HERTZ 1 ■	See page 6-17.
▲▼	■ VOLTS PER HERTZ 2 ■	See page 6-17.
▲▼	■ RESTRICTED GROUND ■ FAULT CURRENTS	See page 6-18.
▲▼	■ TRANSDUCER I/O ■ DCMA INPUTS	See page 6-18.
▲	■ TRANSDUCER I/O ■ RTD INPUTS	See page 6-18.
▲▼	■ USER-PROGRAMMABLE ■ FAULT REPORTS	See page 6-19.
▲▼	■ EVENT RECORDS ■	See page 6-19.
▲▼	■ OSCILLOGRAPHY ■	See page 6-19.
▲▼	■ DATA LOGGER ■	See page 6-20.
▲	■ MAINTENANCE ■	See page 6-20.
▲▼	■ MODEL INFORMATION ■	See page 6-21.
▲	■ FIRMWARE REVISIONS ■	See page 6-21.

▲

■ ACTUAL VALUES

■ RECORDS



▲

■ ACTUAL VALUES

■ PRODUCT INFO



For status reporting, 'On' represents Logic 1 and 'Off' represents Logic 0.

6.2.1 CONTACT INPUTS

PATH: ACTUAL VALUES ⇒ STATUS ⇒ CONTACT INPUTS

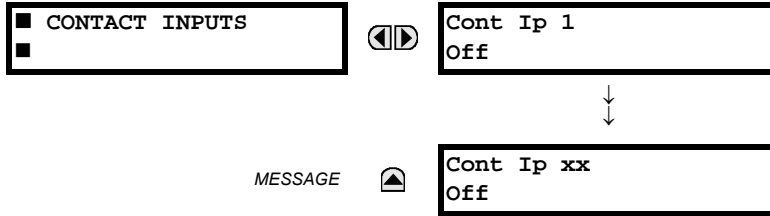

The present status of the contact inputs is shown here. The first line of a message display indicates the ID of the contact input. For example, 'Cont Ip 1' refers to the contact input in terms of the default name-array index. The second line of the display indicates the logic state of the contact input.

6.2.2 VIRTUAL INPUTS

PATH: ACTUAL VALUES ⇒ STATUS ⇒ ↓ VIRTUAL INPUTS

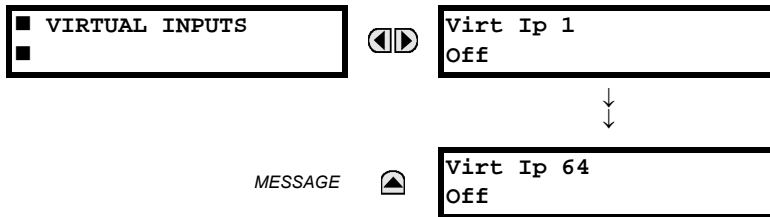

The present status of the 64 virtual inputs is shown here. The first line of a message display indicates the ID of the virtual input. For example, 'Virt Ip 1' refers to the virtual input in terms of the default name. The second line of the display indicates the logic state of the virtual input.



6.2.3 REMOTE INPUTS

PATH: ACTUAL VALUES ⇒ STATUS ⇒ ↓ REMOTE INPUTS

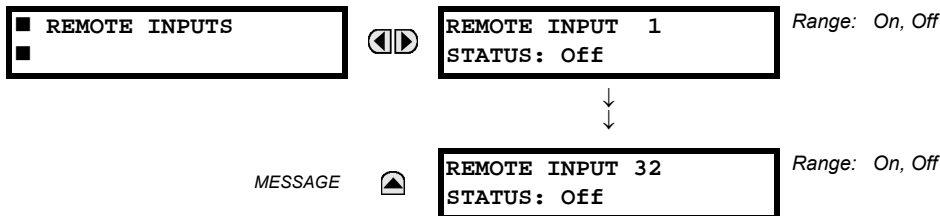

The present state of the 32 remote inputs is shown here.

The state displayed will be that of the remote point unless the remote device has been established to be "Offline" in which case the value shown is the programmed default state for the remote input.

6.2.4 TELEPROTECTION INPUTS

PATH: ACTUAL VALUES ⇒ STATUS ⇒ TELEPROTECTION INPUTS

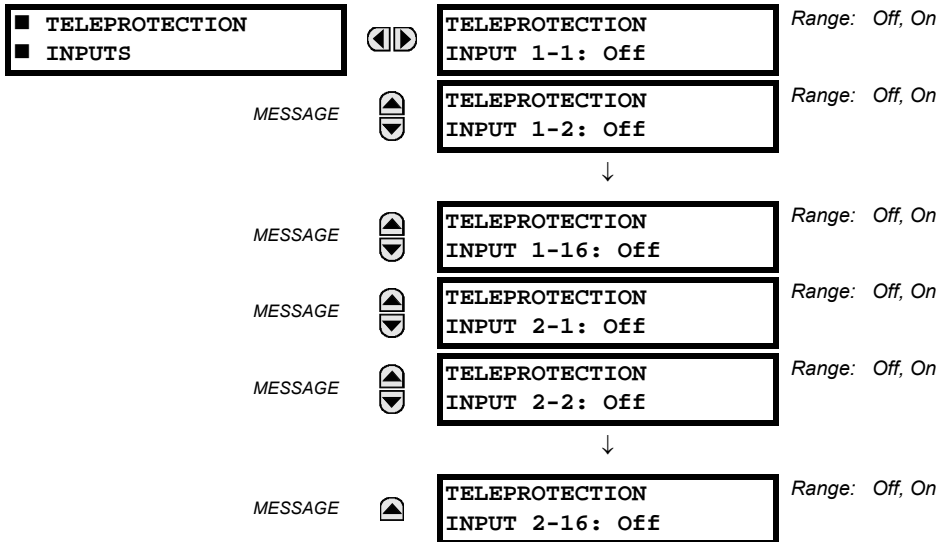

The present state of teleprotection inputs from communication channels 1 and 2 are shown here. The state displayed will be that of corresponding remote output unless the channel is declared failed.

6.2.5 CONTACT OUTPUTS

PATH: ACTUAL VALUES ⇒ STATUS ⇒ CONTACT OUTPUTS

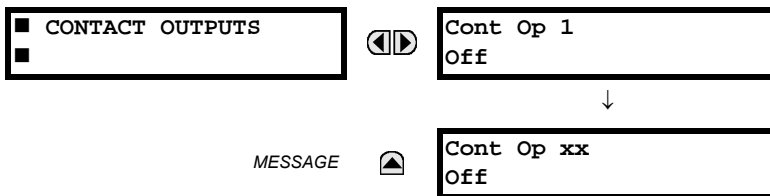

The present state of the contact outputs is shown here. The first line of a message display indicates the ID of the contact output. For example, 'Cont Op 1' refers to the contact output in terms of the default name-array index. The second line of the display indicates the logic state of the contact output.



For Form-A outputs, the state of the voltage(V) and/or current(I) detectors will show as: Off, VOff, IOff, On, VOn, and/or IOn. For Form-C outputs, the state will show as Off or On.

6.2.6 VIRTUAL OUTPUTS

PATH: ACTUAL VALUES ⇒ STATUS ⇒ VIRTUAL OUTPUTS

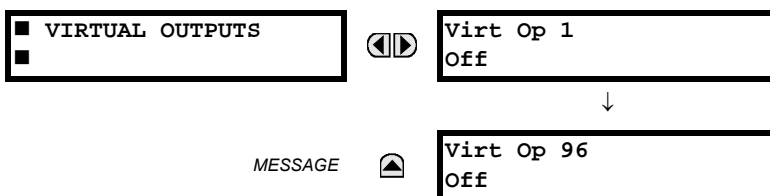

The present state of up to 96 virtual outputs is shown here. The first line of a message display indicates the ID of the virtual output. For example, 'Virt Op 1' refers to the virtual output in terms of the default name-array index. The second line of the display indicates the logic state of the virtual output, as calculated by the FlexLogic™ equation for that output.

6.2.7 REMOTE DEVICES

a) STATUS

PATH: ACTUAL VALUES ⇒ STATUS ⇒ REMOTE DEVICES STATUS

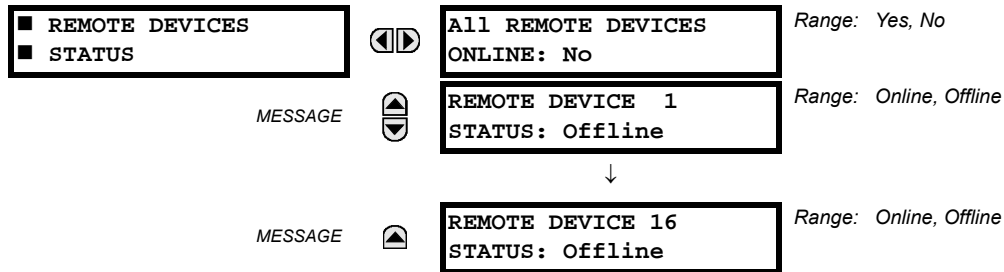

The present state of up to 16 programmed Remote Devices is shown here. The **ALL REMOTE DEVICES ONLINE** message indicates whether or not all programmed Remote Devices are online. If the corresponding state is "No", then at least one required Remote Device is not online.

b) STATISTICS

PATH: ACTUAL VALUES ⇒ STATUS ⇒ REMOTE DEVICES STATISTICS ⇒ REMOTE DEVICE 1(16)

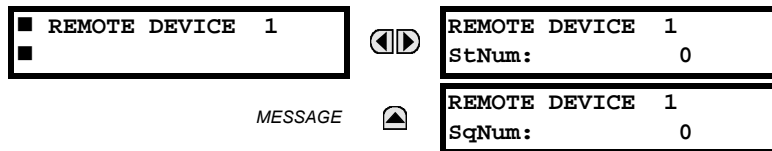

Statistical data (2 types) for up to 16 programmed Remote Devices is shown here.

The **StNum** number is obtained from the indicated Remote Device and is incremented whenever a change of state of at least one DNA or UserSt bit occurs. The **SqNum** number is obtained from the indicated Remote Device and is incremented whenever a GSSE message is sent. This number will rollover to zero when a count of 4,294,967,295 is incremented.

6.2.8 DIGITAL COUNTERS

PATH: ACTUAL VALUES ⇒ STATUS ⇒ DIGITAL COUNTERS ⇒ DIGITAL COUNTERS Counter 1(8)

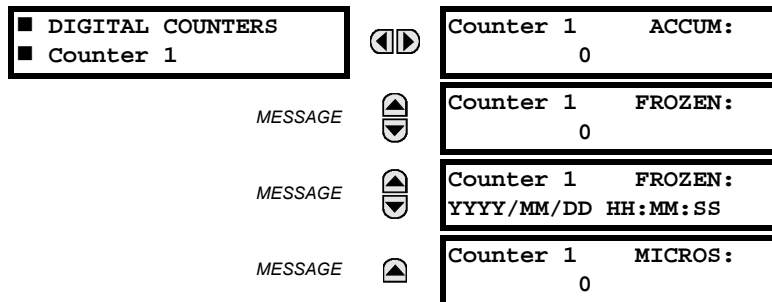

The present status of the 8 digital counters is shown here. The status of each counter, with the user-defined counter name, includes the accumulated and frozen counts (the count units label will also appear). Also included, is the date/time stamp for the frozen count. The **Counter n MICROS** value refers to the microsecond portion of the time stamp.



6.2.9 SELECTOR SWITCHES

PATH: ACTUAL VALUES ⇒ STATUS ⇒ ↓ SELECTOR SWITCHES

■ SELECTOR SWITCHES ■	◀▶	SELECTOR SWITCH 1 POSITION: 0/7	Range: Current Position / 7
MESSAGE	▲	SELECTOR SWITCH 2 POSITION: 0/7	Range: Current Position / 7

The display shows both the current position and the full range. The current position only (an integer from 0 through 7) is the actual value.

6.2.10 FLEX STATES

PATH: ACTUAL VALUES ⇒ STATUS ⇒ ↓ FLEX STATES

■ FLEX STATES ■	◀▶	PARAM 1: Off Off	Range: Off, On
		↓	
MESSAGE	▲	PARAM 256: Off Off	Range: Off, On

There are 256 FlexState bits available. The second line value indicates the state of the given FlexState bit.

6.2.11 ETHERNET

PATH: ACTUAL VALUES ⇒ STATUS ⇒ ↓ ETHERNET

■ ETHERNET ■	◀▶	ETHERNET PRI LINK STATUS: OK	Range: Fail, OK
MESSAGE	▲	ETHERNET SEC LINK STATUS: OK	Range: Fail, OK

These values indicate the status of the primary and secondary Ethernet links.

6.2.12 DIRECT INPUTS

PATH: ACTUAL VALUES ⇒ STATUS ⇒ DIRECT INPUTS

■ DIRECT INPUTS	◀▶	AVG MSG RETURN TIME CH1: 0 ms
MESSAGE	▲▼	UNRETURNED MSG COUNT CH1: 0
MESSAGE	▲▼	CRC FAIL COUNT CH1: 0
MESSAGE	▲▼	AVG MSG RETURN TIME CH2: 0 ms
MESSAGE	▲▼	UNRETURNED MSG COUNT CH2: 0
MESSAGE	▲▼	CRC FAIL COUNT CH2: 0
MESSAGE	▲▼	DIRECT INPUT 1: On
		↓
MESSAGE	▲	DIRECT INPUT 32: On

The **AVERAGE MSG RETURN TIME** is the time taken for direct output messages to return to the sender in a direct input/output ring configuration (this value is not applicable for non-ring configurations). This is a rolling average calculated for the last 10 messages. There are two return times for dual-channel communications modules.

The **UNRETURNED MSG COUNT** values (one per communications channel) count the direct output messages that do not make the trip around the communications ring. The **CRC FAIL COUNT** values (one per communications channel) count the direct output messages that have been received but fail the CRC check. High values for either of these counts may indicate on a problem with wiring, the communication channel, or the relay(s). The **UNRETURNED MSG COUNT** and **CRC FAIL COUNT** values can be cleared using the **CLEAR DIRECT I/O COUNTERS** command.

The **DIRECT INPUT x** values represent the state of the x-th direct input.

6.2.13 DIRECT DEVICES STATUS

PATH: ACTUAL VALUES ⇒ STATUS ⇒ DIRECT DEVICES STATUS

■ DIRECT DEVICES	◀▶	DIRECT DEVICE 1 STATUS: Offline
■ STATUS		
MESSAGE	▲▼	DIRECT DEVICE 2 STATUS: Offline
		↓
MESSAGE	▲	DIRECT DEVICE 16 STATUS: Offline

These actual values represent the state of direct devices 1 through 16.

6.2.14 EGD PROTOCOL STATUS

a) FAST EXCHANGE

PATH: ACTUAL VALUES ⇒ STATUS ⇒ EGD PROTOCOL STATUS ⇒ PRODUCER STATUS ⇒ FAST EXCHANGE 1

■ FAST EXCHANGE 1	◀▶	FAST EXCHANGE 1 SIGNATURE: 0
MESSAGE ▲	▲	FAST EXCHANGE 1 DATA LENGTH: 0

These values provide information that may be useful for debugging an EGD network. The EGD signature and packet size for the fast EGD exchange is displayed.

b) SLOW EXCHANGE

PATH: ACTUAL VALUES ⇒ STATUS ⇒ EGD PROTOCOL STATUS ⇒ PRODUCER STATUS ⇒ SLOW EXCHANGE 1(2)

■ SLOW EXCHANGE 1	◀▶	SLOW EXCHANGE 1 SIGNATURE: 0
MESSAGE ▲	▲	SLOW EXCHANGE 1 DATA LENGTH: 0

These values provide information that may be useful for debugging an EGD network. The EGD signature and packet size for the slow EGD exchanges are displayed.

6.2.15 TELEPROTECTION CHANNEL TESTS

PATH: ACTUAL VALUES ⇒ STATUS ⇒ TELEPROT CH TESTS

■ TELEPROT CH TESTS	◀▶	CHANNEL 1 STATUS: n/a	Range: n/a, FAIL, OK
MESSAGE ▲	▲	CHANNEL 1 LOST PACKETS: 1	Range: 1 to 65535 in steps of 1
MESSAGE ▼	▼	CHANNEL 2 STATUS: n/a	Range: n/a, FAIL, OK
MESSAGE ▲	▲	CHANNEL 2 LOST PACKETS: 1	Range: 1 to 65535 in steps of 1
MESSAGE ▼	▼	VALIDITY OF CHANNEL CONFIGURATION: FAIL	Range: n/a, FAIL, OK

The status information for two channels is shown here.

- **CHANNEL 1(2) STATUS:** This represents the receiver status of each channel. If the value is “OK”, teleprotection is enabled and data is being received from the remote terminal; if the value is “FAIL”, teleprotection enabled and data is not being received from the remote terminal. If “n/a”, teleprotection is disabled.
- **CHANNEL 1(2) LOST PACKETS:** Data is transmitted to the remote terminals in data packets at a rate of 2 packets per cycle. The number of lost packets represents data packets lost in transmission; this count can be reset to 0 through the **COMMANDS** ⇒ **CLEAR RECORDS** menu.
- **VALIDITY OF CHANNEL CONFIGURATION:** This value displays the current state of the communications channel identification check, and hence validity. If a remote relay ID does not match the programmed ID at the local relay, the “FAIL” message will be displayed. The “N/A” value appears if the local relay ID is set to a default value of “0”, the channel is failed, or if the teleprotection inputs/outputs are not enabled.

6.3.1 METERING CONVENTIONS

a) POWER AND ENERGY

The following figure illustrates the conventions established for use in UR-series relays.

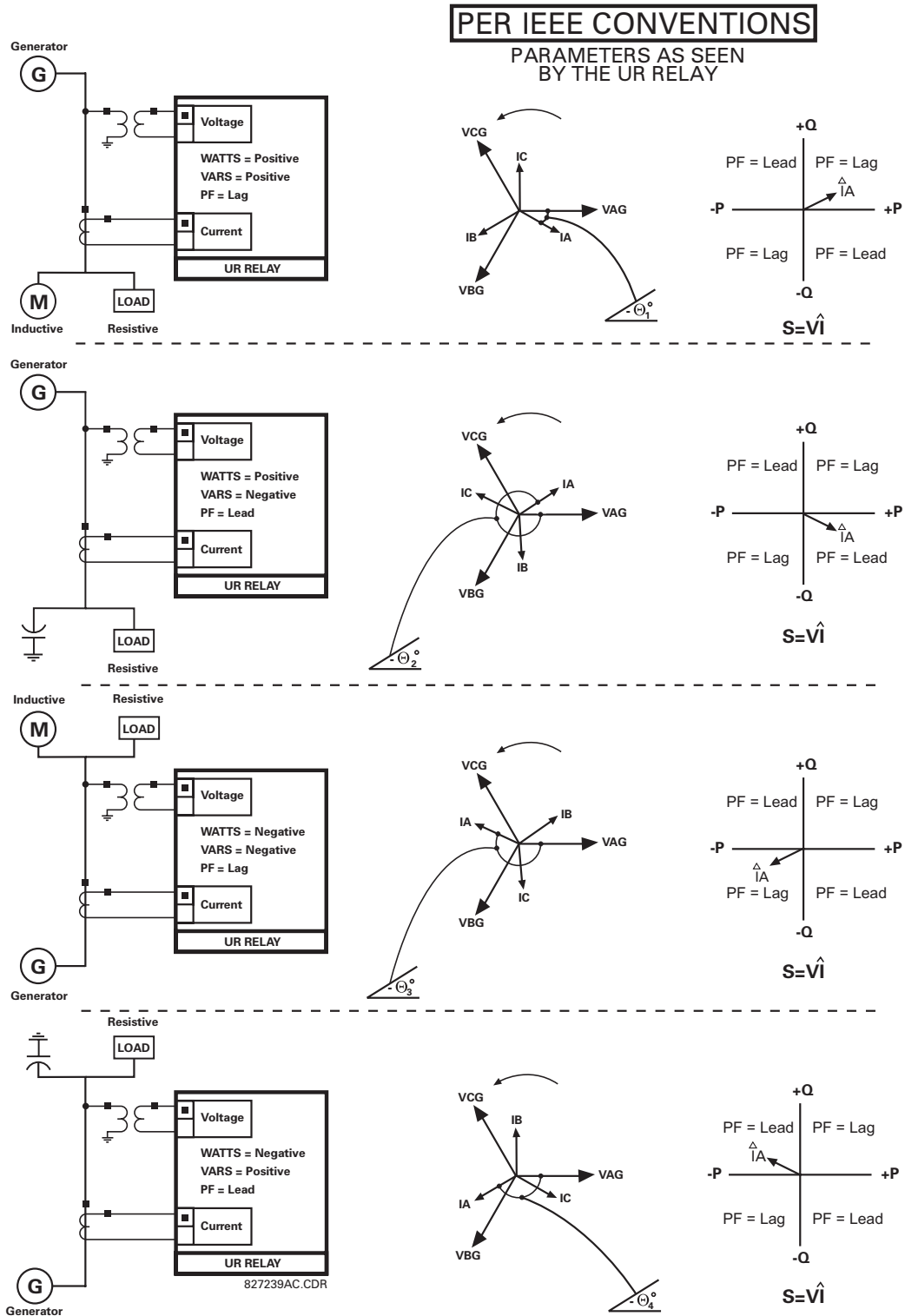

Figure 6-1: FLOW DIRECTION OF SIGNED VALUES FOR WATTS AND VARS

b) PHASE ANGLES

All phasors calculated by UR-series relays and used for protection, control and metering functions are rotating phasors that maintain the correct phase angle relationships with each other at all times.

For display and oscillography purposes, all phasor angles in a given relay are referred to an AC input channel pre-selected by the **SETTINGS** ⇒ **SYSTEM SETUP** ⇒ **POWER SYSTEM** ⇒ **FREQUENCY AND PHASE REFERENCE** setting. This setting defines a particular source to be used as the reference.

The relay will first determine if any “Phase VT” bank is indicated in the Source. If it is, voltage channel VA of that bank is used as the angle reference. Otherwise, the relay determines if any “Aux VT” bank is indicated; if it is, the auxiliary voltage channel of that bank is used as the angle reference. If neither of the two conditions is satisfied, then two more steps of this hierarchical procedure to determine the reference signal include “Phase CT” bank and “Ground CT” bank.

If the AC signal pre-selected by the relay upon configuration is not measurable, the phase angles are not referenced. The phase angles are assigned as positive in the leading direction, and are presented as negative in the lagging direction, to more closely align with power system metering conventions. This is illustrated below.

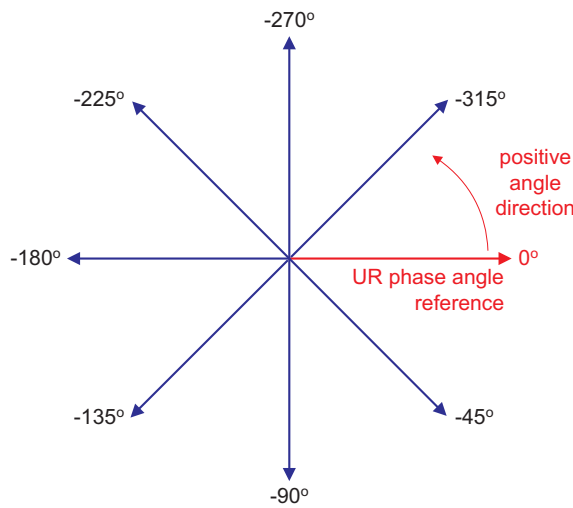

Figure 6–2: UR PHASE ANGLE MEASUREMENT CONVENTION

c) SYMMETRICAL COMPONENTS

The UR-series of relays calculate voltage symmetrical components for the power system phase A line-to-neutral voltage, and symmetrical components of the currents for the power system phase A current. Owing to the above definition, phase angle relations between the symmetrical currents and voltages stay the same irrespective of the connection of instrument transformers. This is important for setting directional protection elements that use symmetrical voltages.

For display and oscillography purposes the phase angles of symmetrical components are referenced to a common reference as described in the previous sub-section.

WYE-CONNECTED INSTRUMENT TRANSFORMERS:

- ABC phase rotation:

$$V_{-0} = \frac{1}{3}(V_{AG} + V_{BG} + V_{CG})$$

$$V_{-1} = \frac{1}{3}(V_{AG} + aV_{BG} + a^2V_{CG})$$

$$V_{-2} = \frac{1}{3}(V_{AG} + a^2V_{BG} + aV_{CG})$$

- ACB phase rotation:

$$V_{-0} = \frac{1}{3}(V_{AG} + V_{BG} + V_{CG})$$

$$V_{-1} = \frac{1}{3}(V_{AG} + a^2V_{BG} + aV_{CG})$$

$$V_{-2} = \frac{1}{3}(V_{AG} + aV_{BG} + a^2V_{CG})$$

The above equations apply to currents as well.

DELTA-CONNECTED INSTRUMENT TRANSFORMERS:

- ABC phase rotation:

$$V_0 = N/A$$

$$V_{-1} = \frac{1\angle-30^\circ}{3\sqrt{3}}(V_{AB} + aV_{BC} + a^2V_{CA})$$

$$V_{-2} = \frac{1\angle30^\circ}{3\sqrt{3}}(V_{AB} + a^2V_{BC} + aV_{CA})$$

- ACB phase rotation:

$$V_0 = N/A$$

$$V_{-1} = \frac{1\angle30^\circ}{3\sqrt{3}}(V_{AB} + a^2V_{BC} + aV_{CA})$$

$$V_{-2} = \frac{1\angle-30^\circ}{3\sqrt{3}}(V_{AB} + aV_{BC} + a^2V_{CA})$$

The zero-sequence voltage is not measurable under the Delta connection of instrument transformers and is defaulted to zero. The table below shows an example of symmetrical components calculations for the ABC phase rotation.

Table 6–1: SYMMETRICAL COMPONENTS CALCULATION EXAMPLE

SYSTEM VOLTAGES, SEC. V *						VT CONN.	RELAY INPUTS, SEC. V			SYMM. COMP, SEC. V		
V _{AG}	V _{BG}	V _{CG}	V _{AB}	V _{BC}	V _{CA}		F5AC	F6AC	F7AC	V ₀	V ₁	V ₂
13.9 ∠0°	76.2 ∠-125°	79.7 ∠-250°	84.9 ∠-313°	138.3 ∠-97°	85.4 ∠-241°	WYE	13.9 ∠0°	76.2 ∠-125°	79.7 ∠-250°	19.5 ∠-192°	56.5 ∠-7°	23.3 ∠-187°
UNKNOWN (only V ₁ and V ₂ can be determined)			84.9 ∠0°	138.3 ∠-144°	85.4 ∠-288°	DELTA	84.9 ∠0°	138.3 ∠-144°	85.4 ∠-288°	N/A	56.5 ∠-54°	23.3 ∠-234°

* The power system voltages are phase-referenced – for simplicity – to V_{AG} and V_{AB}, respectively. This, however, is a relative matter. It is important to remember that the T60 displays are always referenced as specified under **SETTINGS** ⇒ **SYSTEM SETUP** ⇒ **POWER SYSTEM** ⇒ **FREQUENCY AND PHASE REFERENCE**.

The example above is illustrated in the following figure.

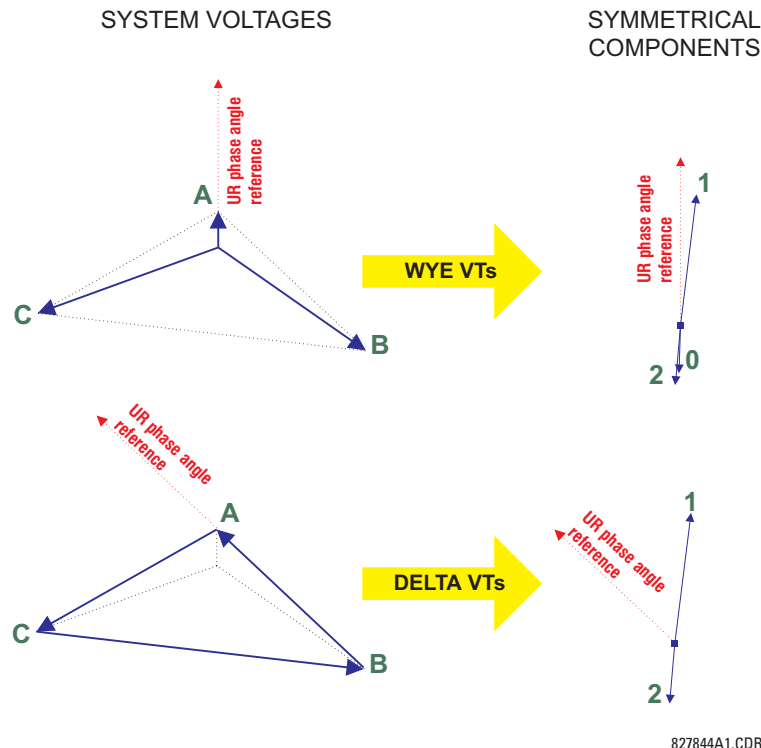

Figure 6–3: MEASUREMENT CONVENTION FOR SYMMETRICAL COMPONENTS

a) DIFFERENTIAL AND RESTRAINT CURRENTS

PATH: ACTUAL VALUES ⇒ ↓ METERING ⇒ TRANSFORMER ⇒ DIFFERENTIAL AND RESTRAINT

<input checked="" type="checkbox"/> DIFFERENTIAL AND <input checked="" type="checkbox"/> RESTRAINT		◀▶	REFERENCE WINDING: Winding 1
MESSAGE	▲▼	▲▼	DIFF PHASOR Iad: 0.000 pu 0.0°
MESSAGE	▲▼	▲▼	REST PHASOR Iar: 0.000 pu 0.0°
MESSAGE	▲▼	▲▼	DIFF 2ND HARM Iad: 0.0% fo 0.0°
MESSAGE	▲▼	▲▼	DIFF 5TH HARM Iad: 0.0% fo 0.0°
MESSAGE	▲▼	▲▼	DIFF PHASOR Ibd: 0.000 pu 0.0°
MESSAGE	▲▼	▲▼	REST PHASOR Ibr: 0.000 pu 0.0°
MESSAGE	▲▼	▲▼	DIFF 2ND HARM Ibd: 0.0% fo 0.0°
MESSAGE	▲▼	▲▼	DIFF 5TH HARM Ibd: 0.0% fo 0.0°
MESSAGE	▲▼	▲▼	DIFF PHASOR Icd: 0.000 pu 0.0°
MESSAGE	▲▼	▲▼	REST PHASOR Icr: 0.000 pu 0.0°
MESSAGE	▲▼	▲▼	DIFF 2ND HARM Icd: 0.0% fo 0.0°
MESSAGE	▲	▲	DIFF 5TH HARM Icd: 0.0% fo 0.0°

b) THERMAL ELEMENTS

PATH: ACTUAL VALUES ⇒ ↓ METERING ⇒ TRANSFORMER ⇒ THERMAL ELEMENTS

<input checked="" type="checkbox"/> THERMAL <input checked="" type="checkbox"/> ELEMENTS		◀▶	TOP OIL °C: 70°C
MESSAGE	▲▼	▲▼	HOTTEST-SPOT °C: 130°
MESSAGE	▲▼	▲▼	AGING FACTOR: 1.2
MESSAGE	▲▼	▲▼	DAILY RATE LOL: 15 hrs
MESSAGE	▲	▲	XFMR LIFE LOST: 100000 hrs

The daily rate loss of life is summarized at 00:00 h, and displayed for the next 24 hour period. The transformer accumulated loss of life in hours is also available. It can be reset by either changing the XFMR INITIAL LOSS OF LIFE setting or through the COMMANDS ⇒ ↓ CLEAR RECORDS ⇒ ↓ CLEAR LOSS OF LIFE RECORDS command.

PATH: ACTUAL VALUES ⇒ ↓ METERING ⇒ SOURCE SRC 1 ⇒



Because energy values are accumulated, these values should be recorded and then reset immediately prior to changing CT or VT characteristics.

<ul style="list-style-type: none"> ■ PHASE CURRENT ■ SRC 1 	◀▶	SRC 1 RMS Ia: 0.000 b: 0.000 c: 0.000 A
MESSAGE	▲▼	SRC 1 RMS Ia: 0.000 A
MESSAGE	▲▼	SRC 1 RMS Ib: 0.000 A
MESSAGE	▲▼	SRC 1 RMS Ic: 0.000 A
MESSAGE	▲▼	SRC 1 RMS In: 0.000 A
MESSAGE	▲▼	SRC 1 PHASOR Ia: 0.000 A 0.0°
MESSAGE	▲▼	SRC 1 PHASOR Ib: 0.000 A 0.0°
MESSAGE	▲▼	SRC 1 PHASOR Ic: 0.000 A 0.0°
MESSAGE	▲▼	SRC 1 PHASOR In: 0.000 A 0.0°
MESSAGE	▲▼	SRC 1 ZERO SEQ I0: 0.000 A 0.0°
MESSAGE	▲▼	SRC 1 POS SEQ I1: 0.000 A 0.0°
MESSAGE	▲	SRC 1 NEG SEQ I2: 0.000 A 0.0°
▲		
<ul style="list-style-type: none"> ■ GROUND CURRENT ■ SRC 1 	◀▶	SRC 1 RMS Ig: 0.000 A
MESSAGE	▲▼	SRC 1 PHASOR Ig: 0.000 A 0.0°
MESSAGE	▲	SRC 1 PHASOR Igd: 0.000 A 0.0°
▲		
<ul style="list-style-type: none"> ■ PHASE VOLTAGE ■ SRC 1 	◀▶	SRC 1 RMS Vag: 0.00 V
MESSAGE	▲▼	SRC 1 RMS Vbg: 0.00 V
MESSAGE	▲▼	SRC 1 RMS Vcg: 0.00 V
MESSAGE	▲▼	SRC 1 PHASOR Vag: 0.000 V 0.0°

MESSAGE	▲▼	SRC 1 PHASOR Vbg: 0.000 V 0.0°
MESSAGE	▲▼	SRC 1 PHASOR Vcg: 0.000 V 0.0°
MESSAGE	▲▼	SRC 1 RMS Vab: 0.00 V
MESSAGE	▲▼	SRC 1 RMS Vbc: 0.00 V
MESSAGE	▲▼	SRC 1 RMS Vca: 0.00 V
MESSAGE	▲▼	SRC 1 PHASOR Vab: 0.000 V 0.0°
MESSAGE	▲▼	SRC 1 PHASOR Vbc: 0.000 V 0.0°
MESSAGE	▲▼	SRC 1 PHASOR Vca: 0.000 V 0.0°
MESSAGE	▲▼	SRC 1 ZERO SEQ V0: 0.000 V 0.0°
MESSAGE	▲▼	SRC 1 POS SEQ V1: 0.000 V 0.0°
MESSAGE	▲	SRC 1 NEG SEQ V2: 0.000 V 0.0°

▲
 AUXILIARY VOLTAGE
 SRC 1

◀▶	SRC 1 RMS Vx: 0.00 V
MESSAGE ▲	SRC 1 PHASOR Vx: 0.000 V 0.0°

▲
 POWER
 SRC 1

◀▶	SRC 1 REAL POWER 3φ: 0.000 W
MESSAGE ▲▼	SRC 1 REAL POWER φa: 0.000 W
MESSAGE ▲▼	SRC 1 REAL POWER φb: 0.000 W
MESSAGE ▲▼	SRC 1 REAL POWER φc: 0.000 W
MESSAGE ▲▼	SRC 1 REACTIVE PWR 3φ: 0.000 var
MESSAGE ▲▼	SRC 1 REACTIVE PWR φa: 0.000 var
MESSAGE ▲▼	SRC 1 REACTIVE PWR φb: 0.000 var
MESSAGE ▲▼	SRC 1 REACTIVE PWR φc: 0.000 var

MESSAGE  SRC 1 APPARENT PWR
3φ: 0.000 VA

MESSAGE  SRC 1 APPARENT PWR
φa: 0.000 VA

MESSAGE  SRC 1 APPARENT PWR
φb: 0.000 VA

MESSAGE  SRC 1 APPARENT PWR
φc: 0.000 VA

MESSAGE  SRC 1 POWER FACTOR
3φ: 1.000

MESSAGE  SRC 1 POWER FACTOR
φa: 1.000

MESSAGE  SRC 1 POWER FACTOR
φb: 1.000

MESSAGE  SRC 1 POWER FACTOR
φc: 1.000



 ENERGY
 SRC 1

 SRC 1 POS WATTHOUR:
0.000 Wh

MESSAGE  SRC 1 NEG WATTHOUR:
0.000 Wh

MESSAGE  SRC 1 POS VARHOUR:
0.000 varh

MESSAGE  SRC 1 NEG VARHOUR:
0.000 varh



 DEMAND
 SRC 1

 SRC 1 DMD IA:
0.000 A

MESSAGE  SRC 1 DMD IA MAX:
0.000 A

MESSAGE  SRC 1 DMD IA DATE:
2001/07/31 16:30:07

MESSAGE  SRC 1 DMD IB:
0.000 A

MESSAGE  SRC 1 DMD IB MAX:
0.000 A

MESSAGE  SRC 1 DMD IB DATE:
2001/07/31 16:30:07

MESSAGE  SRC 1 DMD IC:
0.000 A

MESSAGE  SRC 1 DMD IC MAX:
0.000 A

MESSAGE  SRC 1 DMD IC DATE:
2001/07/31 16:30:07

MESSAGE	▲▼	SRC 1 DMD W: 0.000 W
MESSAGE	▲▼	SRC 1 DMD W MAX: 0.000 W
MESSAGE	▲▼	SRC 1 DMD W DATE: 2001/07/31 16:30:07
MESSAGE	▲▼	SRC 1 DMD VAR: 0.000 var
MESSAGE	▲▼	SRC 1 DMD VAR MAX: 0.000 var
MESSAGE	▲▼	SRC 1 DMD VAR DATE: 2001/07/31 16:30:07
MESSAGE	▲▼	SRC 1 DMD VA: 0.000 VA
MESSAGE	▲▼	SRC 1 DMD VA MAX: 0.000 VA
MESSAGE	▲	SRC 1 DMD VA DATE: 2001/07/31 16:30:07

▲

■ FREQUENCY

■ SRC 1

◀▶	SRC 1 FREQUENCY: 0.00 Hz
----	-----------------------------

▲

■ CURRENT HARMONICS

■ SRC 1

◀▶	SRC 1 THD Ia: 0.0 Ib: 0.0 Ic: 0.0%
----	---------------------------------------

MESSAGE	▲▼	SRC 1 2ND Ia: 0.0 Ib: 0.0 Ic: 0.0%
---------	----	---------------------------------------

MESSAGE	▲▼	SRC 1 3RD Ia: 0.0 Ib: 0.0 Ic: 0.0%
---------	----	---------------------------------------



MESSAGE	▲	SRC 1 25TH Ia: 0.0 Ib: 0.0 Ic: 0.0%
---------	---	--



Four identical Source menus are available. The "SRC 1" text will be replaced by whatever name was programmed by the user for the associated source (see **SETTINGS** ⇒ **SYSTEM SETUP** ⇒ **SIGNAL SOURCES**).

The relay measures (absolute values only) **SOURCE DEMAND** on each phase and average three phase demand for real, reactive, and apparent power. These parameters can be monitored to reduce supplier demand penalties or for statistical metering purposes. Demand calculations are based on the measurement type selected in the **SETTINGS** ⇒ **PRODUCT SETUP** ⇒ **DEMAND** menu. For each quantity, the relay displays the demand over the most recent demand time interval, the maximum demand since the last maximum demand reset, and the time and date stamp of this maximum demand value. Maximum demand quantities can be reset to zero with the **CLEAR RECORDS** ⇒ **CLEAR DEMAND RECORDS** command.

SOURCE FREQUENCY is measured via software-implemented zero-crossing detection of an AC signal. The signal is either a Clarke transformation of three-phase voltages or currents, auxiliary voltage, or ground current as per source configuration (see the **SYSTEM SETUP** ⇒ **POWER SYSTEM** settings). The signal used for frequency estimation is low-pass filtered. The final frequency measurement is passed through a validation filter that eliminates false readings due to signal distortions and transients.

CURRENT HARMONICS are measured for each Source for the THD and 2nd to 25th harmonics per phase.

6.3.4 TRACKING FREQUENCY

PATH: ACTUAL VALUES ⇒ ↓ METERING ⇒ ↓ TRACKING FREQUENCY



The tracking frequency is displayed here. The frequency is tracked based on configuration of the reference source. The **TRACKING FREQUENCY** is based upon positive sequence current phasors from all line terminals and is synchronously adjusted at all terminals. If currents are below 0.125 pu, then the **NOMINAL FREQUENCY** is used.

6.3.5 FLEXELEMENTS™

PATH: ACTUAL VALUES ⇒ ↓ METERING ⇒ ↓ FLEXELEMENTS ⇒ FLEXELEMENT 1(16)



The operating signals for the FlexElements™ are displayed in pu values using the following definitions of the base units.

Table 6–2: FLEXELEMENT™ BASE UNITS

dcmA	BASE = maximum value of the DCMA INPUT MAX setting for the two transducers configured under the +IN and –IN inputs.
FREQUENCY	$f_{BASE} = 1 \text{ Hz}$
PHASE ANGLE	$\phi_{BASE} = 360 \text{ degrees}$ (see the UR angle referencing convention)
POWER FACTOR	$PF_{BASE} = 1.00$
RTDs	BASE = 100°C
SOURCE CURRENT	$I_{BASE} = \text{maximum nominal primary RMS value of the +IN and –IN inputs}$
SOURCE ENERGY (SRC X Positive and Negative Watthours); (SRC X Positive and Negative Varhours)	$E_{BASE} = 10000 \text{ MWh or MVAh, respectively}$
SOURCE POWER	$P_{BASE} = \text{maximum value of } V_{BASE} \times I_{BASE} \text{ for the +IN and –IN inputs}$
SOURCE THD & HARMONICS	BASE = 100% of fundamental frequency component
SOURCE VOLTAGE	$V_{BASE} = \text{maximum nominal primary RMS value of the +IN and –IN inputs}$
VOLTS PER HERTZ	BASE = 1.00 pu
XFMR DIFFERENTIAL CURRENT (Xfmr Iad, Ibd, and Icd Mag)	$I_{BASE} = \text{maximum primary RMS value of the +IN and -IN inputs}$ (CT primary for source currents, and transformer reference primary current for transformer differential currents)
XFMR DIFFERENTIAL HARMONIC CONTENT (Xfmr Harm2 Iad, Ibd, and Icd Mag) (Xfmr Harm5 Iad, Ibd, and Icd Mag)	BASE = 100%
XFMR RESTRAINING CURRENT (Xfmr Iar, Ibr, and Icr Mag)	$I_{BASE} = \text{maximum primary RMS value of the +IN and -IN inputs}$ (CT primary for source currents, and transformer reference primary current for transformer differential currents)

6.3.6 VOLTS PER HERTZ

PATH: ACTUAL VALUES ⇒ ↓ METERING ⇒ ↓ VOLTS PER HERTZ 1(2)



The V/Hz actual values are displayed in this menu.

6.3.7 RESTRICTED GROUND FAULT

PATH: ACTUAL VALUES ⇒ METERING ⇒ RESTRICTED GROUND FAULT CURRENTS ⇒ RESTRICTED GROUND FAULT 1(4)

<ul style="list-style-type: none"> ■ RESTRICTED ■ GROUND FAULT 1 	◀▶	RGF 1 DIFF Igd: 0.000 A
MESSAGE ▲		RGF 1 RESTR Igr: 0.000 A

The differential and restraint current values for the Restricted Ground Fault Element are displayed in this menu.

6.3.8 TRANSDUCER INPUTS/OUTPUTS

PATH: ACTUAL VALUES ⇒ METERING ⇒ TRANSDUCER I/O DCMA INPUTS ⇒ DCMA INPUT xx

<ul style="list-style-type: none"> ■ DCMA INPUT xx ■ 	◀▶	DCMA INPUT xx 0.000 mA
--	----	---------------------------

Actual values for each dcmA input channel that is enabled are displayed with the top line as the programmed Channel ID and the bottom line as the value followed by the programmed units.

PATH: ACTUAL VALUES ⇒ METERING ⇒ TRANSDUCER I/O RTD INPUTS ⇒ RTD INPUT xx

<ul style="list-style-type: none"> ■ RTD INPUT xx ■ 	◀▶	RTD INPUT xx -50 °C
---	----	------------------------

Actual values for each RTD input channel that is enabled are displayed with the top line as the programmed Channel ID and the bottom line as the value.

6.4.1 USER-PROGRAMMABLE FAULT REPORTS

PATH: ACTUAL VALUES ⇒ RECORDS ⇒ USER-PROGRAMMABLE FAULT REPORT

<input type="checkbox"/> USER-PROGRAMMABLE <input type="checkbox"/> FAULT REPORT	<input type="button" value="◀▶"/>	NEWEST RECORD NUMBER: 0
MESSAGE	<input type="button" value="▲"/> <input type="button" value="▼"/>	LAST CLEARED DATE: 2002/8/11 14:23:57
MESSAGE	<input type="button" value="▲"/>	LAST REPORT DATE: 2002/10/09 08:25:27

This menu displays the User-Programmable Fault Report actual values. See the *User-Programmable Fault Report* section in Chapter 5 for additional information on this feature.

6.4.2 EVENT RECORDS

PATH: ACTUAL VALUES ⇒ RECORDS ⇒ EVENT RECORDS

<input type="checkbox"/> EVENT RECORDS <input type="checkbox"/>	<input type="button" value="◀▶"/>	EVENT: XXXX RESET OP(PUSHBUTTON)	
		↓	
MESSAGE	<input type="button" value="▲"/> <input type="button" value="▼"/>	EVENT: 3 POWER ON	<input type="button" value="◀▶"/>
MESSAGE	<input type="button" value="▲"/> <input type="button" value="▼"/>	EVENT: 2 POWER OFF	<input type="button" value="▼"/>
MESSAGE	<input type="button" value="▲"/>	EVENT: 1 EVENTS CLEARED	<input type="button" value="▲"/>

<input type="button" value="▼"/>	EVENT 3 DATE: 2000/07/14
<input type="button" value="▲"/>	EVENT 3 TIME: 14:53:00.03405

Date and Time Stamps

The Event Records menu shows the contextual data associated with up to the last 1024 events, listed in chronological order from most recent to oldest. If all 1024 event records have been filled, the oldest record will be removed as a new record is added. Each event record shows the event identifier/sequence number, cause, and date/time stamp associated with the event trigger. Refer to the **COMMANDS** ⇒ **CLEAR RECORDS** menu for clearing event records.

6.4.3 OSCILLOGRAPHY

PATH: ACTUAL VALUES ⇒ RECORDS ⇒ OSCILLOGRAPHY

<input type="checkbox"/> OSCILLOGRAPHY <input type="checkbox"/>	<input type="button" value="◀▶"/>	FORCE TRIGGER? No	Range: No, Yes
MESSAGE	<input type="button" value="▲"/> <input type="button" value="▼"/>	NUMBER OF TRIGGERS: 0	
MESSAGE	<input type="button" value="▲"/> <input type="button" value="▼"/>	AVAILABLE RECORDS: 0	
MESSAGE	<input type="button" value="▲"/> <input type="button" value="▼"/>	CYCLES PER RECORD: 0.0	
MESSAGE	<input type="button" value="▲"/>	LAST CLEARED DATE: 2000/07/14 15:40:16	

This menu allows the user to view the number of triggers involved and number of oscillography traces available. The 'cycles per record' value is calculated to account for the fixed amount of data storage for oscillography. See the Oscillography section of Chapter 5 for further details.

A trigger can be forced here at any time by setting "Yes" to the **FORCE TRIGGER?** command. Refer to the **COMMANDS** ⇒ **CLEAR RECORDS** menu for clearing the oscillography records.

6.4.4 DATA LOGGER

PATH: ACTUAL VALUES ⇨ DATA LOGGER ⇨ DATA LOGGER

<p>■ DATA LOGGER</p> <p>■</p>	<p>◀▶</p>	<p>OLDEST SAMPLE TIME: 2000/01/14 13:45:51</p>
<p>MESSAGE</p>	<p>▲</p>	<p>NEWEST SAMPLE TIME: 2000/01/14 15:21:19</p>

The **OLDEST SAMPLE TIME** is the time at which the oldest available samples were taken. It will be static until the log gets full, at which time it will start counting at the defined sampling rate. The **NEWEST SAMPLE TIME** is the time the most recent samples were taken. It counts up at the defined sampling rate. If Data Logger channels are defined, then both values are static.

Refer to the **COMMANDS ⇨ CLEAR RECORDS** menu for clearing data logger records.

6.4.5 BREAKER MAINTENANCE

PATH: ACTUAL VALUES ⇨ RECORDS ⇨ MAINTENANCE ⇨ BREAKER 1(4)

<p>■ BREAKER 1</p> <p>■</p>	<p>◀▶</p>	<p>BKR 1 ARCING AMP φA: 0.00 kA2-cyc</p>
<p>MESSAGE</p>	<p>▲▼</p>	<p>BKR 1 ARCING AMP φB: 0.00 kA2-cyc</p>
<p>MESSAGE</p>	<p>▲▼</p>	<p>BKR 1 ARCING AMP φC: 0.00 kA2-cyc</p>
<p>MESSAGE</p>	<p>▲▼</p>	<p>BKR 1 OPERATING TIME φA: 0 ms</p>
<p>MESSAGE</p>	<p>▲▼</p>	<p>BKR 1 OPERATING TIME φB: 0 ms</p>
<p>MESSAGE</p>	<p>▲▼</p>	<p>BKR 1 OPERATING TIME φC: 0 ms</p>
<p>MESSAGE</p>	<p>▲</p>	<p>BKR 1 OPERATING TIME: 0 ms</p>

There is an identical menu for each of the breakers. The **BKR 1 ARCING AMP** values are in units of kA²-cycles. Refer to the **COMMANDS ⇨ CLEAR RECORDS** menu for clearing breaker arcing current records. The **BREAKER OPERATING TIME** is defined as the slowest operating time of breaker poles that were initiated to open.

6.5.1 MODEL INFORMATION

PATH: ACTUAL VALUES ⇌ PRODUCT INFO ⇌ MODEL INFORMATION

<div style="border: 1px solid black; padding: 2px;"> MODEL INFORMATION </div>			ORDER CODE LINE 1: T60-E00-HCH-F8H-H6A	<i>Example code shown</i>
MESSAGE			ORDER CODE LINE 2:	
MESSAGE			ORDER CODE LINE 3:	
MESSAGE			ORDER CODE LINE 4:	
MESSAGE			SERIAL NUMBER:	
MESSAGE			ETHERNET MAC ADDRESS 000000000000	
MESSAGE			MANUFACTURING DATE: 0	<i>Range: YYYY/MM/DD HH:MM:SS</i>
MESSAGE			OPERATING TIME: 0:00:00	

The product order code, serial number, Ethernet MAC address, date/time of manufacture, and operating time are shown here.

6.5.2 FIRMWARE REVISIONS

PATH: ACTUAL VALUES ⇌ PRODUCT INFO ⇌ FIRMWARE REVISIONS

<div style="border: 1px solid black; padding: 2px;"> FIRMWARE REVISIONS </div>			T60 TransformerRelay REVISION: 4.40	<i>Range: 0.00 to 655.35 Revision number of the application firmware.</i>
MESSAGE			MODIFICATION FILE NUMBER: 0	<i>Range: 0 to 65535 (ID of the MOD FILE) Value is 0 for each standard firmware release.</i>
MESSAGE			BOOT PROGRAM REVISION: 1.13	<i>Range: 0.00 to 655.35 Revision number of the boot program firmware.</i>
MESSAGE			FRONT PANEL PROGRAM REVISION: 0.08	<i>Range: 0.00 to 655.35 Revision number of faceplate program firmware.</i>
MESSAGE			COMPILE DATE: 2004/09/15 04:55:16	<i>Range: Any valid date and time. Date and time when product firmware was built.</i>
MESSAGE			BOOT DATE: 2004/09/15 16:41:32	<i>Range: Any valid date and time. Date and time when the boot program was built.</i>

The shown data is illustrative only. A modification file number of 0 indicates that, currently, no modifications have been installed.

7.1.1 COMMANDS MENU

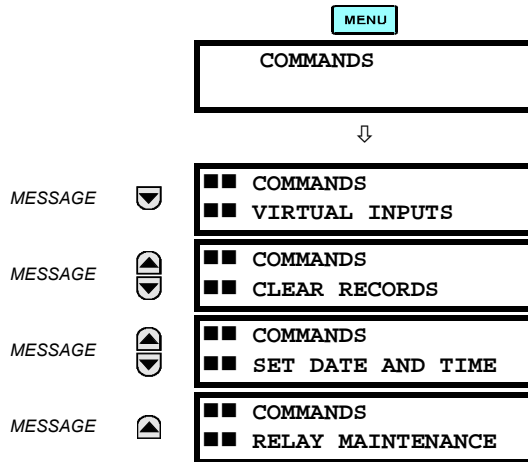

The Commands menu contains relay directives intended for operations personnel. All commands can be protected from unauthorized access via the Command Password; see the Password Security section of Chapter 5. The following flash message appears after successfully command entry:

COMMAND
EXECUTED

7.1.2 VIRTUAL INPUTS

PATH: COMMANDS ⇒ VIRTUAL INPUTS

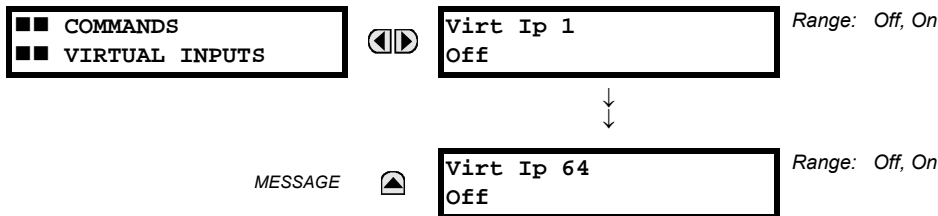

The states of up to 64 virtual inputs are changed here. The first line of the display indicates the ID of the virtual input. The second line indicates the current or selected status of the virtual input. This status will be a logical state 'Off' (0) or 'On' (1).

7.1.3 CLEAR RECORDS

PATH: COMMANDS ⇒ CLEAR RECORDS

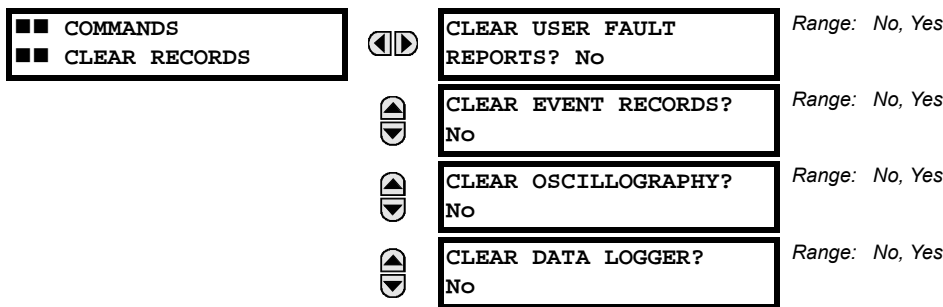

▲ ▼	CLEAR BREAKER 1 ARCING AMPS? No	Range: No, Yes
▲ ▼	CLEAR BREAKER 2 ARCING AMPS? No	Range: No, Yes
▲ ▼	CLEAR DEMAND RECORDS?: No	Range: No, Yes
▲ ▼	CLEAR ENERGY? No	Range: No, Yes
▲ ▼	CLEAR UNAUTHORIZED ACCESS? No	Range: No, Yes
▲ ▼	CLEAR DIRECT I/O COUNTERS? No	Range: No, Yes Valid only for units with Direct I/O module.
▲ ▼	CLEAR LOSS OF LIFE RECORDS? No	Range: No, Yes
▲ ▼	CLEAR TELEPROTECT COUNTERS? No	Range: No, Yes
▲	CLEAR ALL RELAY RECORDS? No	Range: No, Yes

This menu contains commands for clearing historical data such as the Event Records. Data is cleared by changing a command setting to “Yes” and pressing the **ENTER** key. After clearing data, the command setting automatically reverts to “No”.



The **CLEAR ALL RELAY RECORDS** command does not clear the **XFMR LIFE LOST** (transformer loss of life) value.

NOTE

7.1.4 SET DATE AND TIME

PATH: COMMANDS ⇒ SET DATE AND TIME

■ ■ COMMANDS	◀ ▶	SET DATE AND TIME: 2000/01/14 13:47:03	(YYYY/MM/DD HH:MM:SS)
■ ■ SET DATE AND TIME			

The date and time can be entered here via the faceplate keypad only if the IRIG-B or SNTP signal is not in use. The time setting is based on the 24-hour clock. The complete date, as a minimum, must be entered to allow execution of this command. The new time will take effect at the moment the **ENTER** key is clicked.

7.1.5 RELAY MAINTENANCE

PATH: COMMANDS ⇒ RELAY MAINTENANCE

■ ■ COMMANDS	◀ ▶	PERFORM LAMPTEST? No	Range: No, Yes
■ ■ RELAY MAINTENANCE			
	▲	UPDATE ORDER CODE? No	Range: No, Yes

This menu contains commands for relay maintenance purposes. Commands are activated by changing a command setting to “Yes” and pressing the **ENTER** key. The command setting will then automatically revert to “No”.

The **PERFORM LAMPTEST** command turns on all faceplate LEDs and display pixels for a short duration. The **UPDATE ORDER CODE** command causes the relay to scan the backplane for the hardware modules and update the order code to match. If an update occurs, the following message is shown.

UPDATING . . . PLEASE WAIT

There is no impact if there have been no changes to the hardware modules. When an update does not occur, the **ORDER CODE NOT UPDATED** message will be shown.

7.2.1 TARGETS MENU

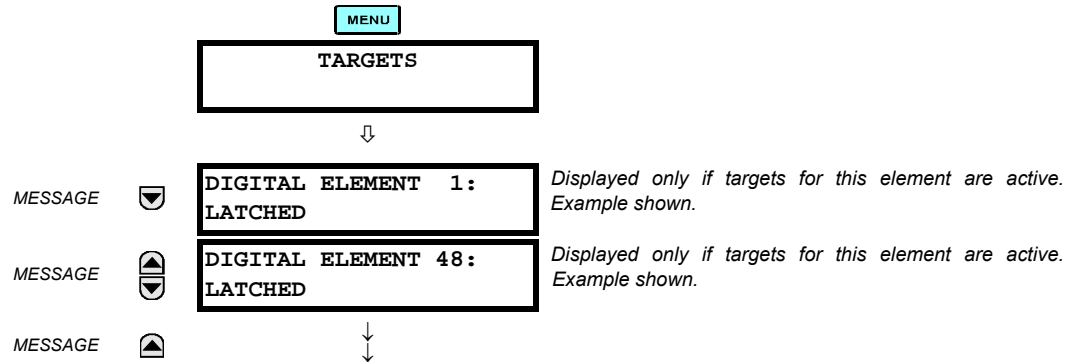

The status of any active targets will be displayed in the Targets menu. If no targets are active, the display will read **No Active Targets**:

7.2.2 TARGET MESSAGES

When there are no active targets, the first target to become active will cause the display to immediately default to that message. If there are active targets and the user is navigating through other messages, and when the default message timer times out (i.e. the keypad has not been used for a determined period of time), the display will again default back to the target message.

The range of variables for the target messages is described below. Phase information will be included if applicable. If a target message status changes, the status with the highest priority will be displayed.

Table 7-1: TARGET MESSAGE PRIORITY STATUS

PRIORITY	ACTIVE STATUS	DESCRIPTION
1	OP	element operated and still picked up
2	PKP	element picked up and timed out
3	LATCHED	element had operated but has dropped out

If a self test error is detected, a message appears indicating the cause of the error. For example **UNIT NOT PROGRAMMED** indicates that the minimal relay settings have not been programmed.

7.2.3 RELAY SELF-TESTS

The relay performs a number of self-test diagnostic checks to ensure device integrity. The two types of self-tests (major and minor) are listed in the tables below. When either type of self-test error occurs, the Trouble LED Indicator will turn on and a target message displayed. All errors record an event in the event recorder. Latched errors can be cleared by pressing the RESET key, providing the condition is no longer present.

Major self-test errors also result in the following:

- the critical fail relay on the power supply module is de-energized
- all other output relays are de-energized and are prevented from further operation
- the faceplate In Service LED indicator is turned off
- a RELAY OUT OF SERVICE event is recorded

Most of the minor self-test errors can be disabled. Refer to the settings in the User-Programmable Self-Tests section in Chapter 5 for additional details.

Table 7–2: MAJOR SELF-TEST ERROR MESSAGES

SELF-TEST ERROR MESSAGE	LATCHED TARGET MESSAGE?	DESCRIPTION OF PROBLEM	HOW OFTEN THE TEST IS PERFORMED	WHAT TO DO
DSP ERRORS: A/D Calibration, A/D Interrupt, A/D Reset, Inter DSP Rx, Sample Int, Rx Interrupt, Tx Interrupt, Rx Sample Index, Invalid Settings, Rx Checksum	Yes	CT/VT module with digital signal processor may have a problem.	Every 1/8th of a cycle.	Cycle the control power (if the problem recurs, contact the factory).
DSP ERROR: INVALID REVISION	Yes	One or more DSP modules in a multiple DSP unit has Rev. C hardware	Rev. C DSP needs to be replaced with a Rev. D DSP.	Contact the factory
EQUIPMENT MISMATCH with 2nd-line detail	No	Configuration of modules does not match the order code stored in the CPU.	On power up; thereafter, the backplane is checked for missing cards every 5 seconds.	Check all modules against the order code, ensure they are inserted properly, and cycle control power (if problem persists, contact factory).
FLEXLOGIC ERR TOKEN with 2nd-line detail	No	FlexLogic™ equations do not compile properly.	Event driven; whenever Flex-Logic™ equations are modified.	Finish all equation editing and use self test to debug any errors.
LATCHING OUTPUT ERROR	No	Discrepancy in the position of a latching contact between firmware and hardware has been detected.	Every 1/8th of a cycle.	The latching output module failed. Replace the Module.
PROGRAM MEMORY Test Failed	Yes	Error was found while checking Flash memory.	Once flash is uploaded with new firmware.	Contact the factory.
UNIT NOT CALIBRATED	No	Settings indicate the unit is not calibrated.	On power up.	Contact the factory.
UNIT NOT PROGRAMMED	No	PRODUCT SETUP ⇔⇓ INSTALLATION setting indicates relay is not in a programmed state.	On power up and whenever the RELAY PROGRAMMED setting is altered.	Program all settings (especially those under PRODUCT SETUP ⇔⇓ INSTALLATION).

Table 7–3: MINOR SELF-TEST ERROR MESSAGES

SELF-TEST ERROR MESSAGE	LATCHED TARGET MESSAGE	DESCRIPTION OF PROBLEM	HOW OFTEN THE TEST IS PERFORMED	WHAT TO DO
BATTERY FAIL	Yes	Battery is not functioning.	Monitored every 5 seconds. Reported after 1 minute if problem persists.	Replace the battery located in the power supply module (1H or 1L).
DIRECT RING BREAK	No	Direct input/output settings configured for a ring, but the connection is not in a ring.	Every second.	Check direct input/output configuration and/or wiring.
DIRECT DEVICE OFF	No	A direct device is configured but not connected.	Every second.	Check direct input/output configuration and/or wiring.
EEPROM DATA ERROR	Yes	The non-volatile memory has been corrupted.	On power up only.	If this message appears after an order code update is preformed, press the RESET key to clear target message. In other cases, contact the factory.
IRIG-B FAILURE	No	A bad IRIG-B input signal has been detected	Monitored whenever an IRIG-B signal is received.	Ensure the IRIG-B cable is connected, check cable functionality (i.e. look for physical damage or perform continuity test), ensure IRIG-B receiver is functioning, and check input signal level (it may be less than specification). If none of these apply, contact the factory.
LATCHING OUT ERROR	Yes	Latching output failure.	Event driven.	Contact the factory.
LOW ON MEMORY	Yes	Memory is close to 100% capacity.	Monitored every 5 seconds.	Contact the factory.
PRI ETHERNET FAIL	Yes	Primary Ethernet connection failed.	Monitored every 2 seconds	Check connections.
PROTOTYPE FIRMWARE	Yes	A prototype version of the firmware is loaded.	On power up only.	Contact the factory.
REMOTE DEVICE OFF	No	One or more GOOSE devices are not responding.	Event driven – occurs when a device programmed to receive GOOSE messages stops receiving. Every 1 to 60 s, depending on GOOSE packets.	Check GOOSE setup.
SEC ETHERNET FAIL	Yes	Sec. Ethernet connection failed.	Monitored every 2 seconds	Check connections.
SNTP FAILURE	No	SNTP server not responding.	10 to 60 seconds.	Check SNTP configuration and/or network connections.
SYSTEM EXCEPTION	Yes	Abnormal restart from modules being removed/inserted when powered-up, abnormal DC supply, or internal relay failure.	Event driven.	Contact the factory.
WATCHDOG ERROR	No	Some tasks are behind schedule.	Event driven.	Contact the factory.

8.1.1 DESCRIPTION

a) OVERVIEW

The following commissioning tests are organized in two parts: general procedures for testing points of the differential-restraint characteristics, and examples of the percent differential element response, based on different transformer configurations and fault current distribution. The following tests can be performed by using either 2 or 3 individually adjustable currents, and do not require additional specialized equipment.

PREPARATION:

1. Select a 0° or 180° transformer phase shift and identical winding connection type into the relay.
2. Select the “Not Within Zone” setting value for each winding grounding setting.
3. Select and set the CT ratios for each winding.
4. Calculate the magnitude compensation factors M[1] and M[2] for each winding.
5. Enable the Transformer Percent Differential element, and enter the required test settings to shape the differential restraint characteristic.
6. Connect the relay test set to inject x current (I_x) into the Winding 1 Phase A CT input, and y current (I_y) into the Winding 2 Phase A CT input.

TESTING:

The tests of the differential restraint characteristic verify the minimum pickup point, the intersection point of Breakpoint 1 and Slope 1, and the intersection point of Breakpoint 2 and Slope 2.

For simplicity, enter the following settings for each winding:

SYSTEM SETUP ⇨ ⇩ **TRANSFORMER** ⇨ ⇩ **WINDING 1(4)** ⇨ ⇩ **WINDING 1(4) CONNECTION:** “Wye”
SYSTEM SETUP ⇨ ⇩ **TRANSFORMER** ⇨ ⇩ **WINDING 1(4)** ⇨ ⇩ **WINDING 1(4) GROUNDING:** “Not Within Zone”
SYSTEM SETUP ⇨ ⇩ **TRANSFORMER** ⇨ ⇩ **WINDING 2(4)** ⇨ ⇩ **WINDING 2(4) ANGLE WRT WINDING 1:** “0°”

If the power transformer phase shift is 0°, the two currents to be injected to the relay should be 180° apart. The 180° phase shift results from the inversion of the field CT, as their positive marks are away from the protected transformer terminals and are connected to the positively marked terminals on the relay.

b) MINIMUM PICKUP

Inject current (I_x) into Winding 1 Phase A and monitor the per-unit Phase A differential current until it exceeds the minimum pickup setting. The theoretical injected current for minimum pickup verification can be computed as follows:

$$I_x = \text{minimum pickup} \times \frac{\text{CT}}{M[1]} \quad (\text{EQ 8.1})$$

where CT is the 1 A or 5 A tap, and M[1] is the calculated magnitude compensation factor (see the Transformer section in Chapter 5 for details on calculating the M[1] and M[2] factors).

c) SLOPE 1 / BREAKPOINT 1

The point of Slope 1 and Breakpoint 1 is tested as follows. Refer to the Differential Restraint Characteristic diagram below for details.

1. Inject current (I_y) into Winding 2 Phase A as follows:

$$I_{yB1} = \text{Breakpoint 1} \times \frac{CT}{M[2]} \quad (\text{EQ 8.2})$$

2. At Breakpoint 1, the injected current I_{XOP1} is determined by:

$$I_{XOP1} = \text{Breakpoint 1} \times (1 - \text{Slope 1}) \times \frac{CT}{M[1]} \quad (\text{EQ 8.3})$$

and the differential current should be equal to:

$$I_d = \text{Slope 1 (in \%)} \times \text{Breakpoint 1 (in pu)} \quad (\text{EQ 8.4})$$

3. Preset the I_x current to $1.05 \times I_{XOP1}$. Switch on the test set. The relay should restrain, as the differential to restraint ratio will become less than the Slope 1 setting. Switch off the current.
4. Preset the I_x current to $0.95 \times I_{XOP1}$. Switch on the test set. The relay should operate. Switch off the current.

To test any other point from the Slope 1 section of the curve, inject a per-unit restraint current smaller than the Breakpoint 1 current and repeat the steps above by substituting the Breakpoint 1 value with the new per-unit restraint current value into the equations above.

d) SLOPE 2 / BREAKPOINT 2

The point of Slope 2 and Breakpoint 2 is tested as follows. Refer to the diagram below for details.

1. Preset the I_y current to a magnitude that results in the restraint current being equal to Breakpoint 2. Use the following calculation to define the magnitude of the injected current:

$$I_{yB2} = \text{Breakpoint 2} \times \frac{CT}{M[2]} \quad (\text{EQ 8.5})$$

2. At the above current (restraint), the I_{XOP2} current required to operate the element is calculated as:

$$I_{XOP2} = \text{Breakpoint 2} \times (1 - \text{Slope 2}) \times \frac{CT}{M[1]} \quad (\text{EQ 8.6})$$

3. Preset the I_x current to $1.05 \times I_{XOP1}$ and switch on the test set. The relay should restrain, as the differential to restraint ratio will become less than the Slope 2 setting. Switch off the current.
4. Preset the I_x current to $0.95 \times I_{XOP1}$. Switch on the test set and verify relay operation. Switch off the current.

To test any point from the Slope 2 portion of the characteristic, inject a per-unit restraint current greater than the Breakpoint 2 current as restraint and repeat the steps above by substituting the Breakpoint 2 value in the equations above with the new per-unit restraint current value.

The above two tests can be repeated for Phases B and C.

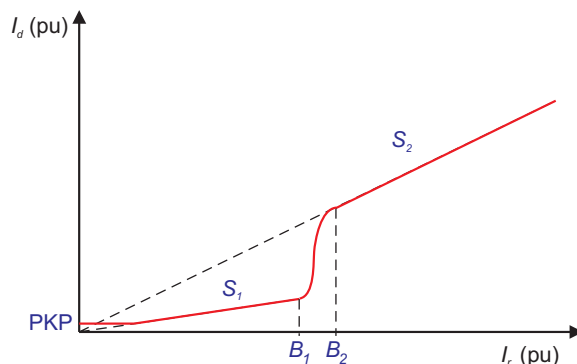

Figure 8-1: DIFFERENTIAL RESTRAINT CHARACTERISTIC

8.2.1 INTRODUCTION

The T60 commissioning tests are based on secondary current injections, where two or three individually adjustable currents are required. The differential protection compares the magnitudes of the varying HV and LV currents in real time. Therefore, the test set currents and their angles must be an exact replica of the HV and LV currents and angles shown on the diagrams, along with the correct CT polarity and orientation.

Ensure that the thermal rating of the relay current inputs is not exceeded. Stopping the injection of the currents to the relay by using contact outputs triggered by protection operation can prevent this from occurring.

Due to the complexity of the mathematics defining the operating characteristic of the region between Breakpoint 1 and 2, the use of a factory-supplied Microsoft Excel simulation utility is highly recommended. This utility indicates graphically whether the relay should operate, based on the settings and winding current injection. This allows the tester to define and confirm various points on the operating characteristic. The spreadsheet can be found at GE Multilin website at <http://www.GEindustrial.com/multilin>.

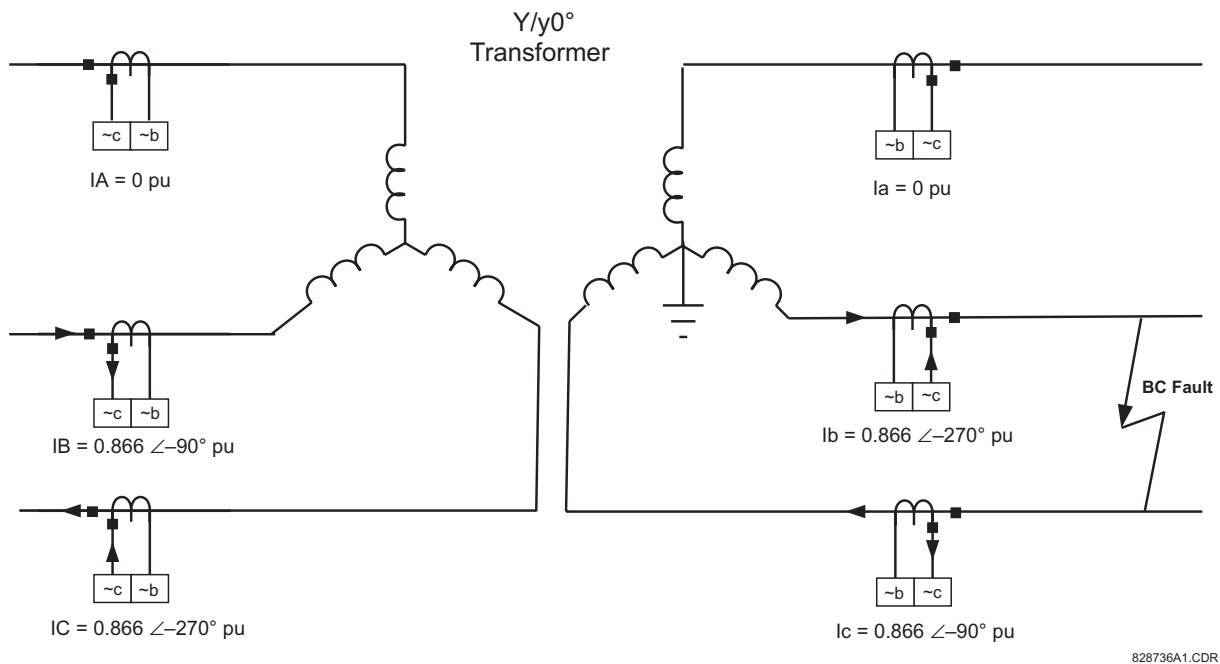

Figure 8-2: CURRENT DISTRIBUTION ON A Y/Y0° TRANSFORMER WITH b-c FAULT ON LV SIDE

Consider the above system, which illustrates the importance of CT orientation, polarity and relay connection. These factors will also apply when performing the tests outlined in the next examples.

The transformer high voltage (HV) and low voltage (LV) side fault currents, and angles are all related. More specifically, the HV and LV primary fault currents are displaced by 180°. The CT polarity marks point away from the protected zone and are connected to the ~a terminals of the relay. The displayed current is what is reported by the relay.



The ~a and ~b terminal identifications are illustrative only. Refer to CT/VT Modules section in Chapter 3 for specific terminal identification.

8.2.2 TEST EXAMPLE 1 (DETAILED)

a) OVERVIEW

TRANSFORMER DATA:

- 20 MVA, 115/12.47 kV, CT (HV) = 200:1, CT (LV) = 1000:1, Y/y0° with a grounded LV neutral

TEST SET CONFIGURATION:

The fault current distribution for an external b-c fault is identical for the HV and LV transformer sides and can be simulated easily with two current sources. Connect the first current source to the relay Phase “B” and “C” terminals, corresponding to the HV winding CTs in series, and the second source to the Phase “b” and “c” relay terminals, corresponding to the LV CTs. Ensure the polarity is correct and the relative phase angles are similar to the shown in the figure; that is, 180° between IB and IC, 180° between Ib and Ic, 180° between IB and Ib, and 180° between IC and Ic. Follow the magnitudes and angles of the injected currents from the tables below to ensure the test will be performed correctly

OPERATING CRITERIA:

The differential element operates if the differential current (I_d) exceeds the characteristic defined by the relay settings for restraint current magnitude (I_r). The differential current I_d is the vector sum of the compensated currents, and I_r is the largest compensated current. Compensation refers to vector and magnitude corrections applied to the currents from the HV and LV transformer sides.

The tests verify the operation and no-operation response for points from all regions of the percentage differential characteristic. These tests are:

- Test for zero differential current
- Minimum Pickup
- Slope 1
- The region between Slope 1 and Slope 2
- Slope 2

RELAY CONFIGURATION:

The AC Inputs and Source are configured as follows:

AC INPUTS SETTING	CT F1	CT M1	SOURCE SETTING	SOURCE 1	SOURCE 2
Phase CT Primary	200	1000	Name	SRC 1	SRC 2
Phase CT Secondary	1	1	Phase CT	F1	M1
Ground CT Primary	X	X	Ground CT	X	X
Ground CT Secondary	X	X	Phase VT	X	X
			Aux VT	X	X

TWO WINDING TRANSFORMER CONFIGURATION:

WINDING 1 SETTINGS	VALUE	WINDING 2 SETTINGS	VALUE	PERCENT DIFF	VALUE
Source	SRC 1	Source	SRC 2	Minimum PKP	0.1 pu
Rated MVA	20 MVA	Rated MVA	20 MVA	Slope 1	15%
Nom Ph-Ph Voltage	115 kV	Nom Ph-Ph Voltage	12.47 kV	Breakpoint 1	2 pu
Connection	Wye	Connection	Wye	Breakpoint 2	8 pu
Grounding	Not within zone	Grounding	Within zone	Slope 2	95%
Angle WRT	0°	Angle WRT	0°		
Resistance 3Ph	10.000 ohms	Resistance 3Ph	10.000 ohms		



APPLICATION OF EXCESSIVE CURRENT ($> 3 \times I_n$) FOR EXTENDED PERIODS WILL CAUSE DAMAGE TO THE RELAY!

WARNING

b) TEST FOR ZERO DIFFERENTIAL CURRENT

1. Inject the following currents into the relay:

WINDING 1		WINDING 2	
PHASE	SINGLE CURRENT (I_1)	PHASE	SINGLE CURRENT (I_2)
A	0 A $\angle 0^\circ$	A	0 A $\angle 0^\circ$
B	0.434 A $\angle 0^\circ$	B	0.8 A $\angle -180^\circ$
C	0.434 A $\angle -180^\circ$	C	0.8 A $\angle 0^\circ$

2. These are determined as follows:

$$I_n(w_1) = \frac{20 \times 10^6 \text{ VA}}{\sqrt{3} \times 115 \times 10^3 \text{ V}} = 100.4 \text{ A}, \quad I_n(w_2) = \frac{20 \times 10^6 \text{ VA}}{\sqrt{3} \times 12.47 \times 10^3 \text{ V}} = 925.98 \text{ A} \quad (\text{EQ 8.7})$$

From the Current Distribution diagram above, there is a $0.866 \text{ pu} \times 100.4 \text{ A} / 200 = 0.434 \text{ A}$ secondary current for HV phases B and C, and a $0.866 \text{ pu} \times 925.98 \text{ A} / 1000 = 0.8 \text{ A}$ secondary current for LV phases b and c.

3. The relay should display the following differential and restraint currents and the element should not operate:

PHASE	DIFFERENTIAL CURRENT (I_d)	PHASE	RESTRAINT CURRENT (I_r)
A	0 $\angle 0^\circ$	A	0 $\angle 0^\circ$
B	0 $\angle 0^\circ$	B	0.801 pu $\angle -180^\circ$
C	0 $\angle 0^\circ$	C	0.801 pu $\angle 0^\circ$

c) MINIMUM PICKUP TEST

Reduce the restraint current I_r to a value lower than 0.67 pu (the restraint corresponding to the intersection of Slope 1 and the pickup). This is obtained from $I_r = 0.1 / 0.15 = 0.67 \text{ pu}$, where 0.1 is the differential setting of minimum pickup, and 0.15 is the setting of Slope 1. Note that

$$0 < I_r < I_r(\text{intersection of Minimum PKP and Slope 1}) \quad (\text{EQ 8.8})$$

4. Change the current magnitude as follows:

WINDING 1		WINDING 2	
PHASE	SINGLE CURRENT (I_1)	PHASE	SINGLE CURRENT (I_2)
A	0 A $\angle 0^\circ$	A	0 A $\angle 0^\circ$
B	0.15 A $\angle 0^\circ$	B	0.23 A $\angle -180^\circ$
C	0.15 A $\angle -180^\circ$	C	0.23 A $\angle 0^\circ$

5. The following differential and restraint current should be read from the T60 actual values menu:

PHASE	DIFFERENTIAL CURRENT (I_d)	PHASE	RESTRAINT CURRENT (I_r)
A	0 $\angle 0^\circ$	A	0 $\angle 0^\circ$
B	0.044 pu $\angle 0^\circ$	B	0.275 pu $\angle -180^\circ$
C	0.044 pu $\angle 0^\circ$	C	0.275 pu $\angle 0^\circ$

The relay will not operate since I_d is still lower than the 0.1 pu MINIMUM PICKUP setting.

6. Increase I_1 to 0.2 A. The differential current increases to $I_d = 0.136 \text{ pu} > \text{Min PKP}$ and $I_r < 0.67 \text{ pu}$.
7. Verify that the Percent Differential element operates and the following are displayed in the actual values menu:

PHASE	DIFFERENTIAL CURRENT (I_d)	PHASE	RESTRAINT CURRENT (I_r)
A	0 $\angle 0^\circ$	A	0 $\angle 0^\circ$
B	0.136 $\angle 0^\circ$	B	0.367 pu $\angle -180^\circ$
C	0.136 $\angle 0^\circ$	C	0.367 pu $\angle 0^\circ$

d) SLOPE 1 TEST

Inject current in such a manner that the magnitude of I_r is larger than the restraint current of 0.67 pu, corresponding to the intersection of the minimum PKP and Slope 1 and smaller than the Breakpoint 1 setting; that is,

$$I_r(\text{intersection of Min PKP and Slope 1}) < I_r(\text{actual}) < I_r(\text{Break 1}) \quad (\text{EQ 8.9})$$

1. Change the current magnitudes as follows:

WINDING 1	
PHASE	SINGLE CURRENT (I_1)
A	0 A $\angle 0^\circ$
B	0.48 A $\angle 0^\circ$
C	0.48 A $\angle -180^\circ$

WINDING 2	
PHASE	SINGLE CURRENT (I_2)
A	0 A $\angle 0^\circ$
B	1 A $\angle -180^\circ$
C	1 A $\angle 0^\circ$

2. The following differential and restraint current should be read from the T60 actual values menu:

PHASE	DIFFERENTIAL CURRENT (I_d)
A	0 $\angle 0^\circ$
B	0.113 pu $\angle 0^\circ$
C	0.113 pu $\angle 0^\circ$

PHASE	RESTRAINT CURRENT (I_r)
A	0 $\angle 0^\circ$
B	1 pu $\angle -180^\circ$
C	1 pu $\angle 0^\circ$



The Percent Differential element will not operate even though I_d is larger than the Minimum Pickup, because I_d is not large enough to make the I_d/I_r ratio larger than the Slope 1 setting of 15%. The actual ratio is 11.3%.

NOTE

3. Adjust the I_1 current as shown below (thereby increasing I_d) and verify that the element operates.

WINDING 1	
PHASE	SINGLE CURRENT (I_1)
A	0 A $\angle 0^\circ$
B	0.45 A $\angle 0^\circ$
C	0.45 A $\angle -180^\circ$

WINDING 2	
PHASE	SINGLE CURRENT (I_2)
A	0 A $\angle 0^\circ$
B	1 A $\angle -180^\circ$
C	1 A $\angle 0^\circ$

4. The following differential and restraint current should appear in the T60 actual values menu:

PHASE	DIFFERENTIAL CURRENT (I_d)
A	0 $\angle 0^\circ$
B	0.170 pu $\angle 0^\circ$
C	0.170 pu $\angle 0^\circ$

PHASE	RESTRAINT CURRENT (I_r)
A	0 $\angle 0^\circ$
B	1 pu $\angle -180^\circ$
C	1 pu $\angle 0^\circ$

5. The actual I_d/I_r ratio is now 17%. Verify that the element operates correctly.

e) INTERMEDIATE CURVE BETWEEN BREAKPOINT 1 AND BREAKPOINT 2

This procedure tests the intermediate section of the differential characteristic curve that lies between the Breakpoint 1 and Breakpoint 2 points (points B_1 and B_2 on the Differential Restraint Characteristic diagram).

- Inject currents so that the magnitude of I_r is between the restraint magnitudes defined by Breakpoint 1 and Breakpoint 2; that is:

$$I_r(\text{at Breakpoint 1}) < I_r < I_r(\text{at Breakpoint 2}) \quad (\text{EQ 8.10})$$

For this example, $2 \text{ pu} < I_r < 8 \text{ pu}$. Remember that the maximum current is the restraint current $I_r = 3.5 \text{ pu}$.

WINDING 1		WINDING 2	
PHASE	SINGLE CURRENT (I_1)	PHASE	SINGLE CURRENT (I_2)
A	0 A $\angle 0^\circ$	A	0 A $\angle 0^\circ$
B	1.2 A $\angle 0^\circ$	B	3.5 A $\angle -180^\circ$
C	1.2 A $\angle -180^\circ$	C	3.5 A $\angle 0^\circ$

- The following differential and restraint current should be read from the T60 actual values menu:

PHASE	DIFFERENTIAL CURRENT (I_d)	PHASE	RESTRAINT CURRENT (I_r)
A	0 $\angle 0^\circ$	A	0 $\angle 0^\circ$
B	1.287 pu $\angle -180^\circ$	B	3.5 pu $\angle -180^\circ$
C	1.287 pu $\angle 0^\circ$	C	3.5 pu $\angle 0^\circ$

The I_d/I_r ratio is 36.77% and the Differential element does not operate because the actual $I_d = 1.287 \text{ pu}$ is still too low at $I_r = 3.5 \text{ pu}$.



Due to the mathematical complexity involved in shaping the curve between Breakpoint 1 and Breakpoint 2, an Excel-based simulation tool is available from the GE Multilin website at <http://www.GEindustrial.com/multilin>. With this tool, the user can see the preset I_d/I_r curve point ratios and the actual I_d/I_r ratio as per the entered test currents. The tool graphically indicates differential and restraint current magnitudes and indicates whether the relay should operate.

- In this example, a ratio of $I_d/I_r > 38\%$ causes the element to trip. Decreasing I_1 as shown in the table below increases the differential current I_d , causing the element to operate.

WINDING 1		WINDING 2	
PHASE	SINGLE CURRENT (I_1)	PHASE	SINGLE CURRENT (I_2)
A	0 A $\angle 0^\circ$	A	0 A $\angle 0^\circ$
B	1.1 A $\angle 0^\circ$	B	3.5 A $\angle -180^\circ$
C	1.1 A $\angle -180^\circ$	C	3.5 A $\angle 0^\circ$

- The following differential and restraint current should be read from the T60 actual values menu:

PHASE	DIFFERENTIAL CURRENT (I_d)	PHASE	RESTRAINT CURRENT (I_r)
A	0 $\angle 0^\circ$	A	0 $\angle 0^\circ$
B	1.471 pu $\angle -180^\circ$	B	3.5 pu $\angle -180^\circ$
C	1.471 pu $\angle 0^\circ$	C	3.5 pu $\angle 0^\circ$

f) SLOPE 2 TEST

Inject currents in such a manner that the magnitude of I_r is larger than the restraint current at Breakpoint 2; that is,

$$I_r > I_r(\text{Break 2}) = 8 \text{ pu} \quad (\text{EQ 8.11})$$

1. Change the current magnitudes as follows:

WINDING 1	
PHASE	SINGLE CURRENT (I_1)
A	0 A $\angle 0^\circ$
B	0.5 A $\angle 0^\circ$
C	0.5 A $\angle -180^\circ$

WINDING 2	
PHASE	SINGLE CURRENT (I_2)
A	0 A $\angle 0^\circ$
B	9 A $\angle -180^\circ$
C	9 A $\angle 0^\circ$

2. The following differential and restraint current should be read from the T60 actual values menu:

PHASE	DIFFERENTIAL CURRENT (I_d)
A	0 $\angle 0^\circ$
B	8.078 pu $\angle -180^\circ$
C	8.078 pu $\angle 0^\circ$

PHASE	RESTRAINT CURRENT (I_r)
A	0 $\angle 0^\circ$
B	9 pu $\angle -180^\circ$
C	9 pu $\angle 0^\circ$

Since $I_d/I_r = 89.8\%$ and lower than the required 95%, the Percent Differential element will not operate.

3. Adjust the I_1 current as shown below (thereby increasing I_d) and verify that the relay operates.

WINDING 1	
PHASE	SINGLE CURRENT (I_1)
A	0 A $\angle 0^\circ$
B	0.2 A $\angle 0^\circ$
C	0.2 A $\angle -180^\circ$

WINDING 2	
PHASE	SINGLE CURRENT (I_2)
A	0 A $\angle 0^\circ$
B	9 A $\angle -180^\circ$
C	9 A $\angle 0^\circ$

4. The following differential and restraint current should appear in the T60 actual values menu:

PHASE	DIFFERENTIAL CURRENT (I_d)
A	0 $\angle 0^\circ$
B	8.631 pu $\angle -180^\circ$
C	8.631 pu $\angle 0^\circ$

PHASE	RESTRAINT CURRENT (I_r)
A	0 $\angle 0^\circ$
B	9 pu $\angle -180^\circ$
C	9 pu $\angle 0^\circ$

5. The actual I_d/I_r ratio is now 95.9%. Verify that the element operates correctly.

g) SUMMARY

The above tests describe the principles of testing the differential element for all regions from the operating characteristic. For verification of more points, one should consider adjusting the magnitude of the restraint current I_r to the desired portion of the characteristic and change the other current to vary I_d until the relay operates. Use the Excel tool to compare the actual and expected operating values.

A blank Result Table is provided at the end of this chapter for convenience.

D/YG30° TRANSFORMER WITH PHASE A TO GROUND FAULT ON THE GROUNDED WYE.

Transformer: D/y30°, 20 MVA, 115/12.47 kv, CT1 (200:1), CT2 (1000:1)

D/y30° Transformer

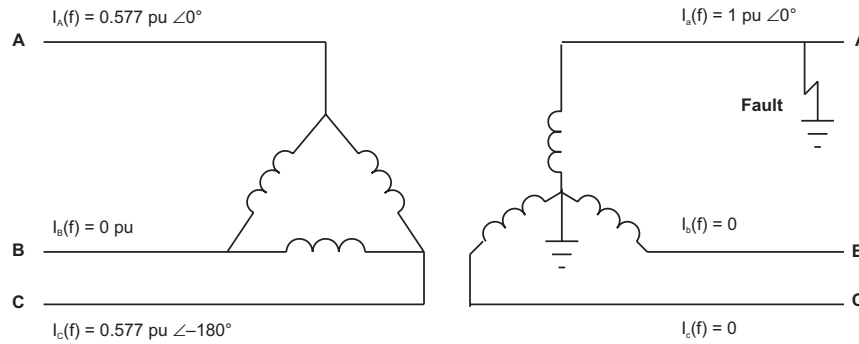

928737A1.CDR

Figure 8-3: CURRENT DISTRIBUTION ON A D/YG30° TRANSFORMER WITH A LV-SIDE GROUND FAULT

TEST	PHASE	INJECTED CURRENT		DISPLAYED CURRENT		STATUS
		W1 CURRENT	W2 CURRENT	DIFFERENTIAL	RESTRAINT	
Balanced Condition	A	0.29 ∠0°	0.926 ∠-180°	0 ∠0°	0.5349 ∠-180°	Not Applicable
	B	0 ∠0°	0 ∠0°	0 ∠0°	0 ∠0°	
	C	0.29 ∠-180°	0 ∠0°	0 ∠0°	0.5349 ∠0°	
Minimum Pickup	A	0.137 ∠0°	0.521 ∠-180°	0.048 ∠0°	0.3 ∠-180°	Block $I_d = 0.048 < \text{Min PKP}$
	B	0 ∠0°	0 ∠0°	0 ∠0°	0 ∠0°	
	C	0.137 ∠-180°	0 ∠0°	0.048 ∠0°	0.3 ∠0°	
Minimum Pickup	A	0.108 ∠0°	0.521 ∠-180°	0.102 ∠0°	0.3 ∠-180°	Operate $I_d = 0.102 > \text{Min PKP}$
	B	0 ∠0°	0 ∠0°	0 ∠0°	0 ∠0°	
	C	0.108 ∠-180°	0 ∠0°	0.102 ∠0°	0.3 ∠0°	
Slope 1	A	0.4435 ∠0°	1.6 ∠-180°	0.110 ∠0°	0.9026 ∠-180°	Block $I_d/I_r = 11.9\%$
	B	0 ∠0°	0 ∠0°	0 ∠0°	0 ∠0°	
	C	0.4435 ∠-180°	0 ∠0°	0 ∠0°	0 ∠0°	
Slope 1	A	0.4425 ∠0°	1.7 ∠-180°	0.165 ∠0°	0.979 ∠-180°	Operate $I_d/I_r = 16.8\%$
	B	0 ∠0°	0 ∠0°	0 ∠0°	0 ∠0°	
	C	0.4425 ∠-180°	0 ∠0°	0.165 ∠0°	0.979 ∠0°	
Intermediate Slope 1 & 2	A	1.2 ∠0°	5 ∠-180°	0.675 ∠-180°	2.882 ∠-180°	Block $I_d/I_r = 23.4\%$
	B	0 ∠0°	0 ∠0°	0 ∠0°	0 ∠0°	
	C	1.2 ∠-180°	0 ∠0°	0.675 ∠0°	2.882 ∠0°	
Intermediate Slope 1 & 2	A	1.1 ∠0°	5 ∠-180°	0.860 ∠-180°	2.882 ∠-180°	Operate $I_d/I_r = 29.8\%$
	B	0 ∠0°	0 ∠0°	0 ∠0°	0 ∠0°	
	C	1.1 ∠-180°	0 ∠0°	0.860 ∠0°	2.882 ∠0°	
Slope 2	A	0.4 ∠0°	15 ∠-180°	7.915 ∠-180°	8.646 ∠-180°	Block $I_d/I_r = 91.5\%$
	B	0 ∠0°	0 ∠0°	0 ∠0°	0 ∠0°	
	C	0.4 ∠-180°	0 ∠0°	7.915 ∠0°	8.646 ∠0°	
Slope 2	A	0.2 ∠0°	15 ∠-180°	7.918 ∠-180°	8.650 ∠-180°	Operate $I_d/I_r = 95.7\%$
	B	0 ∠0°	0 ∠0°	0 ∠0°	0 ∠0°	
	C	0.2 ∠-180°	0 ∠0°	7.916 ∠0°	8.650 ∠0°	

8.2.4 TEST EXAMPLE 3

Yg/D30° TRANSFORMER WITH PHASE B TO C FAULT ON THE DELTA SIDE.

Transformer: Y/D30°, 20 MVA, 115/12.47 kv, CT1 (200:1), CT2 (1000:1)

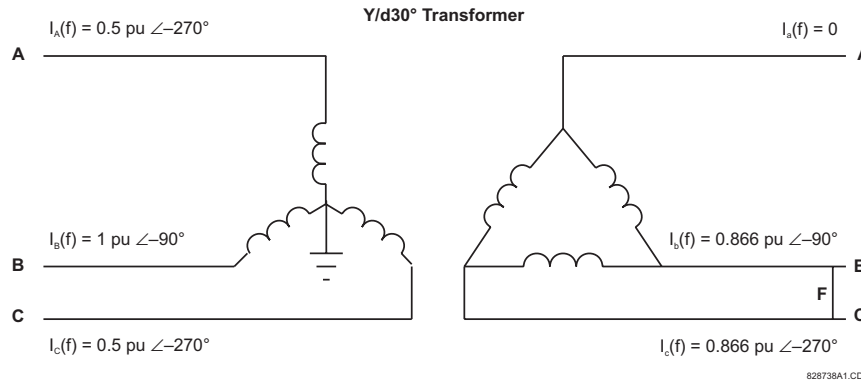

Figure 8–4: CURRENT DISTRIBUTION ON A YG/D30° TRANSFORMER WITH AN a TO b FAULT ON THE LV SIDE

Three adjustable currents are required in this case. The Phase A and C Wye-side line currents, identical in magnitude but displaced by 180°, can be simulated with one current source passed through these relay terminals in series. The second current source simulates the Phase B primary current. The third source simulates the delta “b” and “c” phase currents, also equal in magnitude but displaced by 180°.

TEST	PHASE	INJECTED CURRENT		DISPLAYED CURRENT		STATUS
		W1 CURRENT	W2 CURRENT	DIFFERENTIAL	RESTRAINT	
Balanced Condition	A	0.25 ∠0°	0 ∠0°	0 ∠0°	0 ∠0°	Not Applicable
	B	0.5 ∠-180°	0.8 ∠0°	0 ∠0°	0.8 ∠0°	
	C	0.25 ∠0°	0.8 ∠-180°	0 ∠0°	0.8 ∠-180°	
Min Pickup <i>change the Min PKP to 0.2 pu</i>	A	0.25 ∠0°	0 ∠0°	0 ∠0°	0 ∠0°	Block $I_d = 0.051 < \text{Min PKP}$
	B	0.5 ∠-180°	0.95 ∠0°	0.154 ∠0°	0.948 ∠0°	
	C	0.25 ∠0°	0.95 ∠-180°	0.155 ∠0°	0.950 ∠-180°	
Minimum Pickup	A	0.25 ∠0°	0 ∠0°	0 ∠0°	0 ∠0°	Operate $I_d = 0.102 > \text{Min PKP}$
	B	0.5 ∠-180°	1.05 ∠0°	0.253 ∠0°	1.049 ∠0°	
	C	0.25 ∠0°	1.05 ∠-180°	0.255 ∠0°	1.050 ∠-180°	
Slope 1 <i>return the Min PKP to 0.1 pu</i>	A	0.25 ∠0°	0 ∠0°	0 ∠0°	0 ∠0°	Block $I_d/I_r = 13.2\%$
	B	0.5 ∠-180°	0.92 ∠0°	0.123 ∠0°	0.919 ∠0°	
	C	0.25 ∠0°	0.92 ∠-180°	0.123 ∠0°	0.919 ∠-180°	
Slope 1	A	0.25 ∠0°	0 ∠0°	0 ∠0°	0 ∠0°	Operate $I_d/I_r = 15.9\%$
	B	0.5 ∠-180°	0.95 ∠0°	0.153 ∠0°	0.948 ∠0°	
	C	0.25 ∠0°	0.95 ∠-180°	0.153 ∠0°	0.948 ∠-180°	
Intermediate Slope 1 & 2	A	2 ∠0°	0 ∠0°	0 ∠0°	0 ∠0°	Block $I_d/I_r = 84.3\%$ < 86.6% computed
	B	4 ∠-180°	1 ∠0°	5.37 ∠-180°	6.37 ∠0°	
	C	2 ∠0°	1 ∠-180°	5.37 ∠0°	6.37 ∠-180°	
Intermediate Slope 1 & 2	A	2 ∠0°	0 ∠0°	0 ∠0°	0 ∠0°	Operate $I_d/I_r = 87.5\%$ > 86.6% computed
	B	4 ∠-180°	0.8 ∠0°	5.57 ∠-180°	6.37 ∠0°	
	C	2 ∠0°	0.8 ∠-180°	5.57 ∠0°	6.37 ∠-180°	
Slope 2	A	4 ∠0°	0 ∠0°	0 ∠0°	0 ∠0°	Block $I_d/I_r = 93.7\%$ < Slope 2 = 95%
	B	8 ∠-180°	0.8 ∠0°	11.93 ∠-180°	12.73 ∠0°	
	C	4 ∠0°	0.8 ∠-180°	11.93 ∠0°	12.73 ∠-180°	
Slope 2	A	4 ∠0°	0 ∠0°	0 ∠0°	0 ∠0°	Operate $I_d/I_r = 95.7\%$ > Slope 2 = 95%
	B	8 ∠-180°	0.6 ∠0°	12.13 ∠-180°	12.73 ∠0°	
	C	4 ∠0°	0.6 ∠-180°	12.13 ∠0°	12.73 ∠-180°	

D/D0° TRANSFORMER WITH PHASE B TO C FAULT ON THE SECONDARY DELTA WINDING.

Transformer: D/D0°, 20 MVA, 115/12.47 kv, CT1 (200:1), CT2 (1000:1)

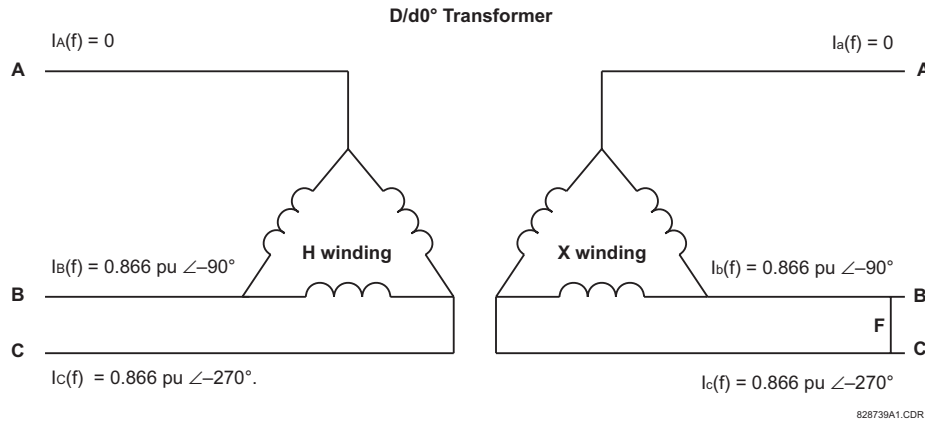
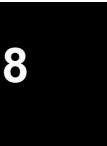

Figure 8–5: CURRENT DISTRIBUTION OF D/D TRANSFORMER WITH AN a TO b FAULT ON THE LV SIDE

TEST	PHASE	INJECTED CURRENT		DISPLAYED CURRENT		STATUS
		W1 CURRENT	W2 CURRENT	DIFFERENTIAL	RESTRAINT	
Balanced Condition	A	0 ∠0°	0 ∠0°	0 ∠0°	0 ∠0°	Not Applicable
	B	0.435 ∠-90°	0.8 ∠-270°	0 ∠0°	0.8 ∠-270°	
	C	0.435 ∠-270°	0.8 ∠-90°	0 ∠0°	0.8 ∠-90°	
Min Pickup	A	0 ∠0°	0 ∠0°	0 ∠0°	0 ∠0°	Block $I_d = 0.065 < \text{Min PKP}$
	B	0.09 ∠-90°	0.23 ∠-270°	0.065 ∠0°	0.230 ∠-270°	
	C	0.09 ∠-270°	0.23 ∠-90°	0.065 ∠0°	0.230 ∠-90°	
Min Pickup	A	0 ∠0°	0 ∠0°	0 ∠0°	0 ∠0°	Operate $I_d = 0.101 > \text{Min PKP}$
	B	0.21 ∠-90°	0.486 ∠-270°	0.102 ∠0°	0.486 ∠-270°	
	C	0.21 ∠-270°	0.486 ∠-90°	0.101 ∠0°	0.486 ∠-90°	
Slope 1	A	0 ∠0°	0 ∠0°	0 ∠0°	0 ∠0°	Block $I_d/I_r = 14\% < 15\%$
	B	0.651 ∠-90°	1.39 ∠-270°	0.195 ∠0°	1.39 ∠-270°	
	C	0.651 ∠-270°	1.39 ∠-90°	0.195 ∠0°	1.39 ∠-90°	
Slope 1	A	0 ∠0°	0 ∠0°	0 ∠0°	0 ∠0°	Operate $I_d/I_r = 16.8\% > 15\%$
	B	0.63 ∠-90°	1.39 ∠-270°	0.233 ∠0°	1.39 ∠-270°	
	C	0.63 ∠-270°	1.39 ∠-90°	0.233 ∠0°	1.39 ∠-90°	
Intermediate Slope 1 & 2	A	0 ∠0°	0 ∠0°	0 ∠0°	0 ∠0°	Block $I_d/I_r = 52.6\% < 60\% \text{ computed}$
	B	1.2 ∠-90°	4.63 ∠-270°	2.44 ∠-270°	4.63 ∠-270°	
	C	1.2 ∠-270°	4.63 ∠-90°	2.44 ∠-90°	4.63 ∠-90°	
Intermediate Slope 1 & 2	A	0 ∠0°	0 ∠0°	0 ∠0°	0 ∠0°	Operate $I_d/I_r = 68.8\% > 60\% \text{ computed}$
	B	0.8 ∠-90°	4.63 ∠-270°	3.18 ∠-270°	4.63 ∠-270°	
	C	0.8 ∠-270°	4.63 ∠-90°	3.18 ∠-90°	4.63 ∠-90°	
Slope 2	A	0 ∠0°	0 ∠0°	0 ∠0°	0 ∠0°	Block $I_d/I_r = 93.2\% < \text{Slope 2} = 95\%$
	B	0.315 ∠-90°	8.33 ∠-270°	7.77 ∠-270°	8.33 ∠-270°	
	C	0.315 ∠-270°	8.33 ∠-90°	7.77 ∠-90°	8.33 ∠-90°	
Slope 2	A	0 ∠0°	0 ∠0°	0 ∠0°	0 ∠0°	Operate $I_d/I_r = 96\% > \text{Slope 2} = 95\%$
	B	0.18 ∠-90°	8.33 ∠-270°	8 ∠-270°	8.33 ∠-270°	
	C	0.18 ∠-270°	8.33 ∠-90°	8 ∠-90°	8.33 ∠-90°	



8.3.1 INRUSH INHIBIT TEST PROCEDURE



The Inrush Inhibit Test requires a secondary injection test capable of producing a current with an adjustable second harmonic component. Use the appropriate commissioning tables at the end of this chapter to record values.

This procedure is based upon the example provided in the Differential Characteristic Test Example section. The transformer parameters are as follows:

Transformer: Y/y0°, 230/69 kV, CT1 (300:1), CT2 (1000:1)

2nd Harmonic Setting = 20%

1. Connect the relay test set to inject current into the Winding 1 Phase A CT input.
2. Inject currents into the relay as shown in the table below until the biased differential element picks up.
3. Confirm that only the percent differential element has operated.
4. Increase the harmonic content until the element drops out. Record this value as the **Inrush Inhibit Level Pickup**.
5. Gradually decrease the harmonic content level until the element picks up. Record this value as the **Inrush Inhibit Level Dropout**.
6. Switch off the current.
7. Repeat steps 1 through 6 for phases B and C.
8. Repeat steps 1 through 7 for Winding 2 (and Windings 3 and 4 if necessary).

Table 8–1: INRUSH INHIBIT TEST SUMMARY

PHASE	INJECTED				DISPLAYED			STATUS
	W1 CURRENT	W1 2ND HARMONIC	W2 CURRENT	W2 2ND HARMONIC	I _d	2ND HARMONIC	I _r	
A	1 A ∠0°	18.01%	0 A ∠0°	0	0.997 pu	18%	0.997 pu	Operate
	1 A ∠0°	19.97%	0 A ∠0°	0	0.997 pu	20%	0.997 pu	Block
B	4 A ∠0°	16.72%	2 A ∠-180°	15%	2 pu	18%	4 pu	Operate
	4 A ∠0°	17.60%	2 A ∠-180°	15%	2 pu	20%	4 pu	Block
C	2 A ∠0°	15%	4 A ∠-180°	16.3%	2 pu	18%	4 pu	Operate
	2 A ∠0°	15%	4 A ∠-180°	17.3%	2 pu	20%	4 pu	Block

The second harmonic inhibit feature can be verified by setting the **INRUSH INHIBIT MODE** setting as follows:

For **INRUSH INHIBIT MODE** set to "2-out-of-3":

1. Set the **INRUSH INHIBIT FUNCTION** to "Trad. 2nd" and the **INRUSH INHIBIT LEVEL** to "20%".
2. Inject currents into one CT bank (one winding only) until the biased differential operates for all three phases.
3. Apply a second harmonic to Phase A higher than the set threshold and monitor operation of Phases A, B, and C. The element should stay operated on all three phases.
4. Apply a second harmonic to Phase B with a level less than the set threshold.
5. Increase the second harmonic level in Phase B. When it passes the set threshold, all three phases of differential protection should drop out.

For **INRUSH INHIBIT MODE** set to "Average":

1. Set the **INRUSH INHIBIT FUNCTION** to "Trad. 2nd" and the **INRUSH INHIBIT LEVEL** to "20%".
2. Inject currents into one CT bank (one winding only) until the biased differential operates for all three phases.
3. Apply a second harmonic to Phase A with a level greater than the set threshold and monitor the operation of the Percent Differential element. The element should drop out when the injected second harmonic level becomes three times larger than the set threshold.

8.4.1 OVEREXCITATION INHIBIT TEST PROCEDURE



The Overexcitation Inhibit Test requires a secondary injection from a source capable of producing an adjustable 5th harmonic component. Use the appropriate commissioning tables at the end of this chapter to record values.

This procedure is based upon the example provided in the Differential Characteristic Test Example section. The transformer parameters are as follows:

Transformer: Y/y0°, 230/69 kV, CT1 (300:1), CT2 (1000:1)

5th Harmonic Setting = 10%

1. Connect the relay test set to inject current into the Winding 1 Phase A CT input.
2. Inject a current into the relay until the biased Differential element operates.
3. Confirm that **ONLY** the differential element has operated.
4. Increase the 5th harmonic content level until the element drops out. Record this value as the **Overexcitation Inhibit Level Pickup**.
5. Gradually decrease the harmonic content level until the element picks up. Record this value as the **Overexcitation Inhibit Level Dropout**.
6. Switch off the current.
7. Repeat steps 1 through 6 for Phases B and C.
8. Repeat steps 1 through 7 for Winding 2 (and Windings 3 and 4 if necessary).

Table 8–2: OVEREXCITATION INHIBIT TEST SUMMARY

PHASE	INJECTED				DISPLAYED			STATUS
	W1 CURRENT	W1 5TH HARMONIC	W2 CURRENT	W2 5TH HARMONIC	I_d	5TH HARMONIC	I_r	
A	1 A $\angle 0^\circ$	8%	0 A $\angle 0^\circ$	0	1 pu	8%	1 pu	Operate
	1 A $\angle 0^\circ$	10%	0 A $\angle 0^\circ$	0	1 pu	10%	1 pu	Block
B	4 A $\angle 0^\circ$	8.5%	2 A $\angle -180^\circ$	9%	2 pu	8%	4 pu	Operate
	4 A $\angle 0^\circ$	9.5%	2 A $\angle -180^\circ$	9%	2 pu	10%	4 pu	Block
C	2 A $\angle 0^\circ$	9%	4 A $\angle -180^\circ$	8.5%	2 pu	8%	4 pu	Operate
	2 A $\angle 0^\circ$	9%	4 A $\angle -180^\circ$	9.5%	2 pu	10%	4 pu	Block

8.5.1 DIFFERENTIAL RESTRAINT TESTS

Table 8-3: DIFFERENTIAL CHARACTERISTIC TEST TABLE

TEST	PHASE	INJECTED CURRENT		DISPLAYED CURRENT		STATUS
		W1 CURRENT	W2 CURRENT	DIFFERENTIAL	RESTRAINT	
Balanced Condition	A					Not Applicable
	B					
	C					
Min Pickup	A					Status: _____
	B					$I_d =$ _____
	C					
Min Pickup	A					Status: _____
	B					$I_d =$ _____
	C					
Slope 1	A					Status: _____
	B					$I_d/I_r =$ _____
	C					
Slope 1	A					Status: _____
	B					$I_d/I_r =$ _____
	C					
Intermediate Slope 1 & 2	A					Status: _____
	B					$I_d/I_r =$ _____
	C					
Intermediate Slope 1 & 2	A					Status: _____
	B					$I_d/I_r =$ _____
	C					
Slope 2	A					Status: _____
	B					$I_d/I_r =$ _____
	C					
Slope 2	A					Status: _____
	B					$I_d/I_r =$ _____
	C					

8.5.2 INRUSH INHIBIT TESTS

Table 8-4: INRUSH INHIBIT TEST TABLE

PHASE	INJECTED				DISPLAYED			STATUS (BLOCK/OPERATE)
	W1 CURRENT (A)	W1 2ND HARMONIC (%)	W2 CURRENT (A)	W2 2ND HARMONIC (%)	I_d (PU)	2ND HARMONIC (%)	I_r (PU)	
A								
B								
C								

8.5.3 OVEREXCITATION INHIBIT TESTS

Table 8-5: OVEREXCITATION INHIBIT TEST RESULTS

PHASE	INJECTED				DISPLAYED			STATUS (BLOCK/ OPERATE)
	W1 CURRENT (A)	W1 5TH HARMONIC (%)	W2 CURRENT (A)	W2 5TH HARMONIC (%)	I_d (PU)	5TH HARMONIC (%)	I_r (PU)	
A								
B								
C								

Table A–1: FLEXANALOG DATA ITEMS (Sheet 1 of 20)

ADDR	DATA ITEM	FLEXANALOG NAME
5792	RGF 1 Differential Gnd Current Mag.	RGF 1 lgd Mag
5794	RGF 1 Restricted Gnd Current Mag.	RGF 1 lgr Mag
5796	RGF 2 Differential Gnd Current Mag.	RGF 2 lgd Mag
5798	RGF 2 Restricted Gnd Current Mag.	RGF 2 lgr Mag
5800	RGF 3 Differential Gnd Current Mag.	RGF 3 lgd Mag
5802	RGF 3 Restricted Gnd Current Mag.	RGF 3 lgr Mag
5804	RGF 4 Differential Gnd Current Mag.	RGF 4 lgd Mag
5806	RGF 4 Restricted Gnd Current Mag.	RGF 4 lgr Mag
5808	RGF 5 Differential Gnd Current Mag.	RGF 5 lgd Mag
5810	RGF 5 Restricted Gnd Current Mag.	RGF 5 lgr Mag
5812	RGF 6 Differential Gnd Current Mag.	RGF 6 lgd Mag
5814	RGF 6 Restricted Gnd Current Mag.	RGF 6 lgr Mag
6144	SRC 1 Phase A Current RMS	SRC 1 Ia RMS
6146	SRC 1 Phase B Current RMS	SRC 1 Ib RMS
6148	SRC 1 Phase C Current RMS	SRC 1 Ic RMS
6150	SRC 1 Neutral Current RMS	SRC 1 In RMS
6152	SRC 1 Phase A Current Magnitude	SRC 1 Ia Mag
6154	SRC 1 Phase A Current Angle	SRC 1 Ia Angle
6155	SRC 1 Phase B Current Magnitude	SRC 1 Ib Mag
6157	SRC 1 Phase B Current Angle	SRC 1 Ib Angle
6158	SRC 1 Phase C Current Magnitude	SRC 1 Ic Mag
6160	SRC 1 Phase C Current Angle	SRC 1 Ic Angle
6161	SRC 1 Neutral Current Magnitude	SRC 1 In Mag
6163	SRC 1 Neutral Current Angle	SRC 1 In Angle
6164	SRC 1 Ground Current RMS	SRC 1 Ig RMS
6166	SRC 1 Ground Current Magnitude	SRC 1 Ig Mag
6168	SRC 1 Ground Current Angle	SRC 1 Ig Angle
6169	SRC 1 Zero Seq. Current Magnitude	SRC 1 I ₀ Mag
6171	SRC 1 Zero Sequence Current Angle	SRC 1 I ₀ Angle
6172	SRC 1 Pos. Seq. Current Magnitude	SRC 1 I ₁ Mag
6174	SRC 1 Pos. Seq. Current Angle	SRC 1 I ₁ Angle
6175	SRC 1 Neg. Seq. Current Magnitude	SRC 1 I ₂ Mag
6177	SRC 1 Neg. Seq. Current Angle	SRC 1 I ₂ Angle
6178	SRC 1 Differential Gnd Current Mag.	SRC 1 lgd Mag
6180	SRC 1 Diff. Gnd. Current Angle	SRC 1 lgd Angle
6208	SRC 2 Phase A Current RMS	SRC 2 Ia RMS
6210	SRC 2 Phase B Current RMS	SRC 2 Ib RMS
6212	SRC 2 Phase C Current RMS	SRC 2 Ic RMS
6214	SRC 2 Neutral Current RMS	SRC 2 In RMS
6216	SRC 2 Phase A Current Magnitude	SRC 2 Ia Mag
6218	SRC 2 Phase A Current Angle	SRC 2 Ia Angle
6219	SRC 2 Phase B Current Magnitude	SRC 2 Ib Mag
6221	SRC 2 Phase B Current Angle	SRC 2 Ib Angle
6222	SRC 2 Phase C Current Magnitude	SRC 2 Ic Mag
6224	SRC 2 Phase C Current Angle	SRC 2 Ic Angle
6225	SRC 2 Neutral Current Magnitude	SRC 2 In Mag
6227	SRC 2 Neutral Current Angle	SRC 2 In Angle
6228	SRC 2 Ground Current RMS	SRC 2 Ig RMS
6230	SRC 2 Ground Current Magnitude	SRC 2 Ig Mag

Table A–1: FLEXANALOG DATA ITEMS (Sheet 2 of 20)

ADDR	DATA ITEM	FLEXANALOG NAME
6232	SRC 2 Ground Current Angle	SRC 2 Ig Angle
6233	SRC 2 Zero Seq. Current Magnitude	SRC 2 I ₀ Mag
6235	SRC 2 Zero Sequence Current Angle	SRC 2 I ₀ Angle
6236	SRC 2 Pos. Seq. Current Magnitude	SRC 2 I ₁ Mag
6238	SRC 2 Positive Seq. Current Angle	SRC 2 I ₁ Angle
6239	SRC 2 Neg. Seq. Current Magnitude	SRC 2 I ₂ Mag
6241	SRC 2 Negative Seq. Current Angle	SRC 2 I ₂ Angle
6242	SRC 2 Differential Gnd Current Mag.	SRC 2 lgd Mag
6244	SRC 2 Diff. Gnd Current Angle	SRC 2 lgd Angle
6272	SRC 3 Phase A Current RMS	SRC 3 Ia RMS
6274	SRC 3 Phase B Current RMS	SRC 3 Ib RMS
6276	SRC 3 Phase C Current RMS	SRC 3 Ic RMS
6278	SRC 3 Neutral Current RMS	SRC 3 In RMS
6280	SRC 3 Phase A Current Magnitude	SRC 3 Ia Mag
6282	SRC 3 Phase A Current Angle	SRC 3 Ia Angle
6283	SRC 3 Phase B Current Magnitude	SRC 3 Ib Mag
6285	SRC 3 Phase B Current Angle	SRC 3 Ib Angle
6286	SRC 3 Phase C Current Magnitude	SRC 3 Ic Mag
6288	SRC 3 Phase C Current Angle	SRC 3 Ic Angle
6289	SRC 3 Neutral Current Magnitude	SRC 3 In Mag
6291	SRC 3 Neutral Current Angle	SRC 3 In Angle
6292	SRC 3 Ground Current RMS	SRC 3 Ig RMS
6294	SRC 3 Ground Current Magnitude	SRC 3 Ig Mag
6296	SRC 3 Ground Current Angle	SRC 3 Ig Angle
6297	SRC 3 Zero Seq. Current Magnitude	SRC 3 I ₀ Mag
6299	SRC 3 Zero Sequence Current Angle	SRC 3 I ₀ Angle
6300	SRC 3 Pos. Seq. Current Magnitude	SRC 3 I ₁ Mag
6302	SRC 3 Positive Seq. Current Angle	SRC 3 I ₁ Angle
6303	SRC 3 Neg. Seq. Current Magnitude	SRC 3 I ₂ Mag
6305	SRC 3 Negative Seq. Current Angle	SRC 3 I ₂ Angle
6306	SRC 3 Differential Gnd Current Mag.	SRC 3 lgd Mag
6308	SRC 3 Differential Gnd Current Angle	SRC 3 lgd Angle
6336	SRC 4 Phase A Current RMS	SRC 4 Ia RMS
6338	SRC 4 Phase B Current RMS	SRC 4 Ib RMS
6340	SRC 4 Phase C Current RMS	SRC 4 Ic RMS
6342	SRC 4 Neutral Current RMS	SRC 4 In RMS
6344	SRC 4 Phase A Current Magnitude	SRC 4 Ia Mag
6346	SRC 4 Phase A Current Angle	SRC 4 Ia Angle
6347	SRC 4 Phase B Current Magnitude	SRC 4 Ib Mag
6349	SRC 4 Phase B Current Angle	SRC 4 Ib Angle
6350	SRC 4 Phase C Current Magnitude	SRC 4 Ic Mag
6352	SRC 4 Phase C Current Angle	SRC 4 Ic Angle
6353	SRC 4 Neutral Current Magnitude	SRC 4 In Mag
6355	SRC 4 Neutral Current Angle	SRC 4 In Angle
6356	SRC 4 Ground Current RMS	SRC 4 Ig RMS
6358	SRC 4 Ground Current Magnitude	SRC 4 Ig Mag
6360	SRC 4 Ground Current Angle	SRC 4 Ig Angle
6361	SRC 4 Zero Seq. Current Magnitude	SRC 4 I ₀ Mag
6363	SRC 4 Zero Seq. Current Angle	SRC 4 I ₀ Angle

A

Table A-1: FLEXANALOG DATA ITEMS (Sheet 3 of 20)

ADDR	DATA ITEM	FLEXANALOG NAME
6364	SRC 4 Positive Seq. Current Mag.	SRC 4 I_1 Mag
6366	SRC 4 Positive Seq. Current Angle	SRC 4 I_1 Angle
6367	SRC 4 Negative Seq. Current Mag.	SRC 4 I_2 Mag
6369	SRC 4 Negative Seq. Current Angle	SRC 4 I_2 Angle
6370	SRC 4 Differential Gnd Current Mag.	SRC 4 Igd Mag
6372	SRC 4 Differential Gnd Current Angle	SRC 4 Igd Angle
6656	SRC 1 Phase AG Voltage RMS	SRC 1 Vag RMS
6658	SRC 1 Phase BG Voltage RMS	SRC 1 Vbg RMS
6660	SRC 1 Phase CG Voltage RMS	SRC 1 Vcg RMS
6662	SRC 1 Phase AG Voltage Magnitude	SRC 1 Vag Mag
6664	SRC 1 Phase AG Voltage Angle	SRC 1 Vag Angle
6665	SRC 1 Phase BG Voltage Magnitude	SRC 1 Vbg Mag
6667	SRC 1 Phase BG Voltage Angle	SRC 1 Vbg Angle
6668	SRC 1 Phase CG Voltage Magnitude	SRC 1 Vcg Mag
6670	SRC 1 Phase CG Voltage Angle	SRC 1 Vcg Angle
6671	SRC 1 Phase AB Voltage RMS	SRC 1 Vab RMS
6673	SRC 1 Phase BC Voltage RMS	SRC 1 Vbc RMS
6675	SRC 1 Phase CA Voltage RMS	SRC 1 Vca RMS
6677	SRC 1 Phase AB Voltage Magnitude	SRC 1 Vab Mag
6679	SRC 1 Phase AB Voltage Angle	SRC 1 Vab Angle
6680	SRC 1 Phase BC Voltage Magnitude	SRC 1 Vbc Mag
6682	SRC 1 Phase BC Voltage Angle	SRC 1 Vbc Angle
6683	SRC 1 Phase CA Voltage Magnitude	SRC 1 Vca Mag
6685	SRC 1 Phase CA Voltage Angle	SRC 1 Vca Angle
6686	SRC 1 Auxiliary Voltage RMS	SRC 1 Vx RMS
6688	SRC 1 Auxiliary Voltage Magnitude	SRC 1 Vx Mag
6690	SRC 1 Auxiliary Voltage Angle	SRC 1 Vx Angle
6691	SRC 1 Zero Sequence Voltage Mag.	SRC 1 V_0 Mag
6693	SRC 1 Zero Sequence Voltage Angle	SRC 1 V_0 Angle
6694	SRC 1 Positive Seq. Voltage Mag.	SRC 1 V_1 Mag
6696	SRC 1 Positive Seq. Voltage Angle	SRC 1 V_1 Angle
6697	SRC 1 Negative Seq. Voltage Mag.	SRC 1 V_2 Mag
6699	SRC 1 Negative Seq. Voltage Angle	SRC 1 V_2 Angle
6720	SRC 2 Phase AG Voltage RMS	SRC 2 Vag RMS
6722	SRC 2 Phase BG Voltage RMS	SRC 2 Vbg RMS
6724	SRC 2 Phase CG Voltage RMS	SRC 2 Vcg RMS
6726	SRC 2 Phase AG Voltage Magnitude	SRC 2 Vag Mag
6728	SRC 2 Phase AG Voltage Angle	SRC 2 Vag Angle
6729	SRC 2 Phase BG Voltage Magnitude	SRC 2 Vbg Mag
6731	SRC 2 Phase BG Voltage Angle	SRC 2 Vbg Angle
6732	SRC 2 Phase CG Voltage Magnitude	SRC 2 Vcg Mag
6734	SRC 2 Phase CG Voltage Angle	SRC 2 Vcg Angle
6735	SRC 2 Phase AB Voltage RMS	SRC 2 Vab RMS
6737	SRC 2 Phase BC Voltage RMS	SRC 2 Vbc RMS
6739	SRC 2 Phase CA Voltage RMS	SRC 2 Vca RMS
6741	SRC 2 Phase AB Voltage Magnitude	SRC 2 Vab Mag
6743	SRC 2 Phase AB Voltage Angle	SRC 2 Vab Angle
6744	SRC 2 Phase BC Voltage Magnitude	SRC 2 Vbc Mag
6746	SRC 2 Phase BC Voltage Angle	SRC 2 Vbc Angle
6747	SRC 2 Phase CA Voltage Magnitude	SRC 2 Vca Mag
6749	SRC 2 Phase CA Voltage Angle	SRC 2 Vca Angle
6750	SRC 2 Auxiliary Voltage RMS	SRC 2 Vx RMS

Table A-1: FLEXANALOG DATA ITEMS (Sheet 4 of 20)

ADDR	DATA ITEM	FLEXANALOG NAME
6752	SRC 2 Auxiliary Voltage Magnitude	SRC 2 Vx Mag
6754	SRC 2 Auxiliary Voltage Angle	SRC 2 Vx Angle
6755	SRC 2 Zero Seq. Voltage Magnitude	SRC 2 V_0 Mag
6757	SRC 2 Zero Sequence Voltage Angle	SRC 2 V_0 Angle
6758	SRC 2 Positive Seq. Voltage Mag.	SRC 2 V_1 Mag
6760	SRC 2 Positive Seq. Voltage Angle	SRC 2 V_1 Angle
6761	SRC 2 Negative Seq. Voltage Mag.	SRC 2 V_2 Mag
6763	SRC 2 Negative Seq. Voltage Angle	SRC 2 V_2 Angle
6784	SRC 3 Phase AG Voltage RMS	SRC 3 Vag RMS
6786	SRC 3 Phase BG Voltage RMS	SRC 3 Vbg RMS
6788	SRC 3 Phase CG Voltage RMS	SRC 3 Vcg RMS
6790	SRC 3 Phase AG Voltage Magnitude	SRC 3 Vag Mag
6792	SRC 3 Phase AG Voltage Angle	SRC 3 Vag Angle
6793	SRC 3 Phase BG Voltage Magnitude	SRC 3 Vbg Mag
6795	SRC 3 Phase BG Voltage Angle	SRC 3 Vbg Angle
6796	SRC 3 Phase CG Voltage Magnitude	SRC 3 Vcg Mag
6798	SRC 3 Phase CG Voltage Angle	SRC 3 Vcg Angle
6799	SRC 3 Phase AB Voltage RMS	SRC 3 Vab RMS
6801	SRC 3 Phase BC Voltage RMS	SRC 3 Vbc RMS
6803	SRC 3 Phase CA Voltage RMS	SRC 3 Vca RMS
6805	SRC 3 Phase AB Voltage Magnitude	SRC 3 Vab Mag
6807	SRC 3 Phase AB Voltage Angle	SRC 3 Vab Angle
6808	SRC 3 Phase BC Voltage Magnitude	SRC 3 Vbc Mag
6810	SRC 3 Phase BC Voltage Angle	SRC 3 Vbc Angle
6811	SRC 3 Phase CA Voltage Magnitude	SRC 3 Vca Mag
6813	SRC 3 Phase CA Voltage Angle	SRC 3 Vca Angle
6814	SRC 3 Auxiliary Voltage RMS	SRC 3 Vx RMS
6816	SRC 3 Auxiliary Voltage Magnitude	SRC 3 Vx Mag
6818	SRC 3 Auxiliary Voltage Angle	SRC 3 Vx Angle
6819	SRC 3 Zero Seq. Voltage Magnitude	SRC 3 V_0 Mag
6821	SRC 3 Zero Sequence Voltage Angle	SRC 3 V_0 Angle
6822	SRC 3 Positive Seq. Voltage Mag.	SRC 3 V_1 Mag
6824	SRC 3 Positive Seq. Voltage Angle	SRC 3 V_1 Angle
6825	SRC 3 Negative Seq. Voltage Mag.	SRC 3 V_2 Mag
6827	SRC 3 Negative Seq. Voltage Angle	SRC 3 V_2 Angle
6848	SRC 4 Phase AG Voltage RMS	SRC 4 Vag RMS
6850	SRC 4 Phase BG Voltage RMS	SRC 4 Vbg RMS
6852	SRC 4 Phase CG Voltage RMS	SRC 4 Vcg RMS
6854	SRC 4 Phase AG Voltage Magnitude	SRC 4 Vag Mag
6856	SRC 4 Phase AG Voltage Angle	SRC 4 Vag Angle
6857	SRC 4 Phase BG Voltage Magnitude	SRC 4 Vbg Mag
6859	SRC 4 Phase BG Voltage Angle	SRC 4 Vbg Angle
6860	SRC 4 Phase CG Voltage Magnitude	SRC 4 Vcg Mag
6862	SRC 4 Phase CG Voltage Angle	SRC 4 Vcg Angle
6863	SRC 4 Phase AB Voltage RMS	SRC 4 Vab RMS
6865	SRC 4 Phase BC Voltage RMS	SRC 4 Vbc RMS
6867	SRC 4 Phase CA Voltage RMS	SRC 4 Vca RMS
6869	SRC 4 Phase AB Voltage Magnitude	SRC 4 Vab Mag
6871	SRC 4 Phase AB Voltage Angle	SRC 4 Vab Angle
6872	SRC 4 Phase BC Voltage Magnitude	SRC 4 Vbc Mag
6874	SRC 4 Phase BC Voltage Angle	SRC 4 Vbc Angle
6875	SRC 4 Phase CA Voltage Magnitude	SRC 4 Vca Mag

Table A-1: FLEXANALOG DATA ITEMS (Sheet 5 of 20)

ADDR	DATA ITEM	FLEXANALOG NAME
6877	SRC 4 Phase CA Voltage Angle	SRC 4 Vca Angle
6878	SRC 4 Auxiliary Voltage RMS	SRC 4 Vx RMS
6880	SRC 4 Auxiliary Voltage Magnitude	SRC 4 Vx Mag
6882	SRC 4 Auxiliary Voltage Angle	SRC 4 Vx Angle
6883	SRC 4 Zero Seq. Voltage Magnitude	SRC 4 V_0 Mag
6885	SRC 4 Zero Sequence Voltage Angle	SRC 4 V_0 Angle
6886	SRC 4 Positive Seq. Voltage Mag.	SRC 4 V_1 Mag
6888	SRC 4 Positive Seq. Voltage Angle	SRC 4 V_1 Angle
6889	SRC 4 Negative Seq. Voltage Mag.	SRC 4 V_2 Mag
6891	SRC 4 Negative Seq. Voltage Angle	SRC 4 V_2 Angle
7168	SRC 1 Three Phase Real Power	SRC 1 P
7170	SRC 1 Phase A Real Power	SRC 1 Pa
7172	SRC 1 Phase B Real Power	SRC 1 Pb
7174	SRC 1 Phase C Real Power	SRC 1 Pc
7176	SRC 1 Three Phase Reactive Power	SRC 1 Q
7178	SRC 1 Phase A Reactive Power	SRC 1 Qa
7180	SRC 1 Phase B Reactive Power	SRC 1 Qb
7182	SRC 1 Phase C Reactive Power	SRC 1 Qc
7184	SRC 1 Three Phase Apparent Power	SRC 1 S
7186	SRC 1 Phase A Apparent Power	SRC 1 Sa
7188	SRC 1 Phase B Apparent Power	SRC 1 Sb
7190	SRC 1 Phase C Apparent Power	SRC 1 Sc
7192	SRC 1 Three Phase Power Factor	SRC 1 PF
7193	SRC 1 Phase A Power Factor	SRC 1 Phase A PF
7194	SRC 1 Phase B Power Factor	SRC 1 Phase B PF
7195	SRC 1 Phase C Power Factor	SRC 1 Phase C PF
7200	SRC 2 Three Phase Real Power	SRC 2 P
7202	SRC 2 Phase A Real Power	SRC 2 Pa
7204	SRC 2 Phase B Real Power	SRC 2 Pb
7206	SRC 2 Phase C Real Power	SRC 2 Pc
7208	SRC 2 Three Phase Reactive Power	SRC 2 Q
7210	SRC 2 Phase A Reactive Power	SRC 2 Qa
7212	SRC 2 Phase B Reactive Power	SRC 2 Qb
7214	SRC 2 Phase C Reactive Power	SRC 2 Qc
7216	SRC 2 Three Phase Apparent Power	SRC 2 S
7218	SRC 2 Phase A Apparent Power	SRC 2 Sa
7220	SRC 2 Phase B Apparent Power	SRC 2 Sb
7222	SRC 2 Phase C Apparent Power	SRC 2 Sc
7224	SRC 2 Three Phase Power Factor	SRC 2 PF
7225	SRC 2 Phase A Power Factor	SRC 2 Phase A PF
7226	SRC 2 Phase B Power Factor	SRC 2 Phase B PF
7227	SRC 2 Phase C Power Factor	SRC 2 Phase C PF
7232	SRC 3 Three Phase Real Power	SRC 3 P
7234	SRC 3 Phase A Real Power	SRC 3 Pa
7236	SRC 3 Phase B Real Power	SRC 3 Pb
7238	SRC 3 Phase C Real Power	SRC 3 Pc
7240	SRC 3 Three Phase Reactive Power	SRC 3 Q
7242	SRC 3 Phase A Reactive Power	SRC 3 Qa
7244	SRC 3 Phase B Reactive Power	SRC 3 Qb
7246	SRC 3 Phase C Reactive Power	SRC 3 Qc
7248	SRC 3 Three Phase Apparent Power	SRC 3 S
7250	SRC 3 Phase A Apparent Power	SRC 3 Sa

Table A-1: FLEXANALOG DATA ITEMS (Sheet 6 of 20)

ADDR	DATA ITEM	FLEXANALOG NAME
7252	SRC 3 Phase B Apparent Power	SRC 3 Sb
7254	SRC 3 Phase C Apparent Power	SRC 3 Sc
7256	SRC 3 Three Phase Power Factor	SRC 3 PF
7257	SRC 3 Phase A Power Factor	SRC 3 Phase A PF
7258	SRC 3 Phase B Power Factor	SRC 3 Phase B PF
7259	SRC 3 Phase C Power Factor	SRC 3 Phase C PF
7264	SRC 4 Three Phase Real Power	SRC 4 P
7266	SRC 4 Phase A Real Power	SRC 4 Pa
7268	SRC 4 Phase B Real Power	SRC 4 Pb
7270	SRC 4 Phase C Real Power	SRC 4 Pc
7272	SRC 4 Three Phase Reactive Power	SRC 4 Q
7274	SRC 4 Phase A Reactive Power	SRC 4 Qa
7276	SRC 4 Phase B Reactive Power	SRC 4 Qb
7278	SRC 4 Phase C Reactive Power	SRC 4 Qc
7280	SRC 4 Three Phase Apparent Power	SRC 4 S
7282	SRC 4 Phase A Apparent Power	SRC 4 Sa
7284	SRC 4 Phase B Apparent Power	SRC 4 Sb
7286	SRC 4 Phase C Apparent Power	SRC 4 Sc
7288	SRC 4 Three Phase Power Factor	SRC 4 PF
7289	SRC 4 Phase A Power Factor	SRC 4 Phase A PF
7290	SRC 4 Phase B Power Factor	SRC 4 Phase B PF
7291	SRC 4 Phase C Power Factor	SRC 4 Phase C PF
7552	SRC 1 Frequency	SRC 1 Frequency
7553	SRC 2 Frequency	SRC 2 Frequency
7554	SRC 3 Frequency	SRC 3 Frequency
7555	SRC 4 Frequency	SRC 4 Frequency
7680	SRC 1 Demand Ia	SRC 1 Demand Ia
7682	SRC 1 Demand Ib	SRC 1 Demand Ib
7684	SRC 1 Demand Ic	SRC 1 Demand Ic
7686	SRC 1 Demand Watt	SRC 1 Demand Watt
7688	SRC 1 Demand Var	SRC 1 Demand var
7690	SRC 1 Demand Va	SRC 1 Demand Va
7696	SRC 2 Demand Ia	SRC 2 Demand Ia
7698	SRC 2 Demand Ib	SRC 2 Demand Ib
7700	SRC 2 Demand Ic	SRC 2 Demand Ic
7702	SRC 2 Demand Watt	SRC 2 Demand Watt
7704	SRC 2 Demand Var	SRC 2 Demand var
7706	SRC 2 Demand Va	SRC 2 Demand Va
7712	SRC 3 Demand Ia	SRC 3 Demand Ia
7714	SRC 3 Demand Ib	SRC 3 Demand Ib
7716	SRC 3 Demand Ic	SRC 3 Demand Ic
7718	SRC 3 Demand Watt	SRC 3 Demand Watt
7720	SRC 3 Demand Var	SRC 3 Demand var
7722	SRC 3 Demand Va	SRC 3 Demand Va
7728	SRC 4 Demand Ia	SRC 4 Demand Ia
7730	SRC 4 Demand Ib	SRC 4 Demand Ib
7732	SRC 4 Demand Ic	SRC 4 Demand Ic
7734	SRC 4 Demand Watt	SRC 4 Demand Watt
7736	SRC 4 Demand Var	SRC 4 Demand var
7738	SRC 4 Demand Va	SRC 4 Demand Va
8064	SRC 1 Va THD	SRC 1 Va THD
8065	SRC 1 Va Harmonics	SRC 1 Va Harm[0]

A

A

Table A-1: FLEXANALOG DATA ITEMS (Sheet 7 of 20)

ADDR	DATA ITEM	FLEXANALOG NAME
8066	SRC 1 Va Harmonics	SRC 1 Va Harm[1]
8067	SRC 1 Va Harmonics	SRC 1 Va Harm[2]
8068	SRC 1 Va Harmonics	SRC 1 Va Harm[3]
8069	SRC 1 Va Harmonics	SRC 1 Va Harm[4]
8070	SRC 1 Va Harmonics	SRC 1 Va Harm[5]
8071	SRC 1 Va Harmonics	SRC 1 Va Harm[6]
8072	SRC 1 Va Harmonics	SRC 1 Va Harm[7]
8073	SRC 1 Va Harmonics	SRC 1 Va Harm[8]
8074	SRC 1 Va Harmonics	SRC 1 Va Harm[9]
8075	SRC 1 Va Harmonics	SRC 1 Va Harm[10]
8076	SRC 1 Va Harmonics	SRC 1 Va Harm[11]
8077	SRC 1 Va Harmonics	SRC 1 Va Harm[12]
8078	SRC 1 Va Harmonics	SRC 1 Va Harm[13]
8079	SRC 1 Va Harmonics	SRC 1 Va Harm[14]
8080	SRC 1 Va Harmonics	SRC 1 Va Harm[15]
8081	SRC 1 Va Harmonics	SRC 1 Va Harm[16]
8082	SRC 1 Va Harmonics	SRC 1 Va Harm[17]
8083	SRC 1 Va Harmonics	SRC 1 Va Harm[18]
8084	SRC 1 Va Harmonics	SRC 1 Va Harm[19]
8085	SRC 1 Va Harmonics	SRC 1 Va Harm[20]
8086	SRC 1 Va Harmonics	SRC 1 Va Harm[21]
8087	SRC 1 Va Harmonics	SRC 1 Va Harm[22]
8088	SRC 1 Va Harmonics	SRC 1 Va Harm[23]
8089	SRC 1 Vb THD	SRC 1 Vb THD
8090	SRC 1 Vb Harmonics	SRC 1 Vb Harm[0]
8091	SRC 1 Vb Harmonics	SRC 1 Vb Harm[1]
8092	SRC 1 Vb Harmonics	SRC 1 Vb Harm[2]
8093	SRC 1 Vb Harmonics	SRC 1 Vb Harm[3]
8094	SRC 1 Vb Harmonics	SRC 1 Vb Harm[4]
8095	SRC 1 Vb Harmonics	SRC 1 Vb Harm[5]
8096	SRC 1 Vb Harmonics	SRC 1 Vb Harm[6]
8097	SRC 1 Vb Harmonics	SRC 1 Vb Harm[7]
8098	SRC 1 Vb Harmonics	SRC 1 Vb Harm[8]
8099	SRC 1 Vb Harmonics	SRC 1 Vb Harm[9]
8100	SRC 1 Vb Harmonics	SRC 1 Vb Harm[10]
8101	SRC 1 Vb Harmonics	SRC 1 Vb Harm[11]
8102	SRC 1 Vb Harmonics	SRC 1 Vb Harm[12]
8103	SRC 1 Vb Harmonics	SRC 1 Vb Harm[13]
8104	SRC 1 Vb Harmonics	SRC 1 Vb Harm[14]
8105	SRC 1 Vb Harmonics	SRC 1 Vb Harm[15]
8106	SRC 1 Vb Harmonics	SRC 1 Vb Harm[16]
8107	SRC 1 Vb Harmonics	SRC 1 Vb Harm[17]
8108	SRC 1 Vb Harmonics	SRC 1 Vb Harm[18]
8109	SRC 1 Vb Harmonics	SRC 1 Vb Harm[19]
8110	SRC 1 Vb Harmonics	SRC 1 Vb Harm[20]
8111	SRC 1 Vb Harmonics	SRC 1 Vb Harm[21]
8112	SRC 1 Vb Harmonics	SRC 1 Vb Harm[22]
8113	SRC 1 Vb Harmonics	SRC 1 Vb Harm[23]
8114	SRC 1 Vc THD	SRC 1 Vc THD
8115	SRC 1 Vc Harmonics	SRC 1 Vc Harm[0]
8116	SRC 1 Vc Harmonics	SRC 1 Vc Harm[1]
8117	SRC 1 Vc Harmonics	SRC 1 Vc Harm[2]

Table A-1: FLEXANALOG DATA ITEMS (Sheet 8 of 20)

ADDR	DATA ITEM	FLEXANALOG NAME
8118	SRC 1 Vc Harmonics	SRC 1 Vc Harm[3]
8119	SRC 1 Vc Harmonics	SRC 1 Vc Harm[4]
8120	SRC 1 Vc Harmonics	SRC 1 Vc Harm[5]
8121	SRC 1 Vc Harmonics	SRC 1 Vc Harm[6]
8122	SRC 1 Vc Harmonics	SRC 1 Vc Harm[7]
8123	SRC 1 Vc Harmonics	SRC 1 Vc Harm[8]
8124	SRC 1 Vc Harmonics	SRC 1 Vc Harm[9]
8125	SRC 1 Vc Harmonics	SRC 1 Vc Harm[10]
8126	SRC 1 Vc Harmonics	SRC 1 Vc Harm[11]
8127	SRC 1 Vc Harmonics	SRC 1 Vc Harm[12]
8128	SRC 1 Vc Harmonics	SRC 1 Vc Harm[13]
8129	SRC 1 Vc Harmonics	SRC 1 Vc Harm[14]
8130	SRC 1 Vc Harmonics	SRC 1 Vc Harm[15]
8131	SRC 1 Vc Harmonics	SRC 1 Vc Harm[16]
8132	SRC 1 Vc Harmonics	SRC 1 Vc Harm[17]
8133	SRC 1 Vc Harmonics	SRC 1 Vc Harm[18]
8134	SRC 1 Vc Harmonics	SRC 1 Vc Harm[19]
8135	SRC 1 Vc Harmonics	SRC 1 Vc Harm[20]
8136	SRC 1 Vc Harmonics	SRC 1 Vc Harm[21]
8137	SRC 1 Vc Harmonics	SRC 1 Vc Harm[22]
8138	SRC 1 Vc Harmonics	SRC 1 Vc Harm[23]
8139	SRC 2 Va THD	SRC 2 Va THD
8140	SRC 2 Va Harmonics	SRC 2 Va Harm[0]
8141	SRC 2 Va Harmonics	SRC 2 Va Harm[1]
8142	SRC 2 Va Harmonics	SRC 2 Va Harm[2]
8143	SRC 2 Va Harmonics	SRC 2 Va Harm[3]
8144	SRC 2 Va Harmonics	SRC 2 Va Harm[4]
8145	SRC 2 Va Harmonics	SRC 2 Va Harm[5]
8146	SRC 2 Va Harmonics	SRC 2 Va Harm[6]
8147	SRC 2 Va Harmonics	SRC 2 Va Harm[7]
8148	SRC 2 Va Harmonics	SRC 2 Va Harm[8]
8149	SRC 2 Va Harmonics	SRC 2 Va Harm[9]
8150	SRC 2 Va Harmonics	SRC 2 Va Harm[10]
8151	SRC 2 Va Harmonics	SRC 2 Va Harm[11]
8152	SRC 2 Va Harmonics	SRC 2 Va Harm[12]
8153	SRC 2 Va Harmonics	SRC 2 Va Harm[13]
8154	SRC 2 Va Harmonics	SRC 2 Va Harm[14]
8155	SRC 2 Va Harmonics	SRC 2 Va Harm[15]
8156	SRC 2 Va Harmonics	SRC 2 Va Harm[16]
8157	SRC 2 Va Harmonics	SRC 2 Va Harm[17]
8158	SRC 2 Va Harmonics	SRC 2 Va Harm[18]
8159	SRC 2 Va Harmonics	SRC 2 Va Harm[19]
8160	SRC 2 Va Harmonics	SRC 2 Va Harm[20]
8161	SRC 2 Va Harmonics	SRC 2 Va Harm[21]
8162	SRC 2 Va Harmonics	SRC 2 Va Harm[22]
8163	SRC 2 Va Harmonics	SRC 2 Va Harm[23]
8164	SRC 2 Vb THD	SRC 2 Vb THD
8165	SRC 2 Vb Harmonics	SRC 2 Vb Harm[0]
8166	SRC 2 Vb Harmonics	SRC 2 Vb Harm[1]
8167	SRC 2 Vb Harmonics	SRC 2 Vb Harm[2]
8168	SRC 2 Vb Harmonics	SRC 2 Vb Harm[3]
8169	SRC 2 Vb Harmonics	SRC 2 Vb Harm[4]

Table A-1: FLEXANALOG DATA ITEMS (Sheet 9 of 20)

ADDR	DATA ITEM	FLEXANALOG NAME
8170	SRC 2 Vb Harmonics	SRC 2 Vb Harm[5]
8171	SRC 2 Vb Harmonics	SRC 2 Vb Harm[6]
8172	SRC 2 Vb Harmonics	SRC 2 Vb Harm[7]
8173	SRC 2 Vb Harmonics	SRC 2 Vb Harm[8]
8174	SRC 2 Vb Harmonics	SRC 2 Vb Harm[9]
8175	SRC 2 Vb Harmonics	SRC 2 Vb Harm[10]
8176	SRC 2 Vb Harmonics	SRC 2 Vb Harm[11]
8177	SRC 2 Vb Harmonics	SRC 2 Vb Harm[12]
8178	SRC 2 Vb Harmonics	SRC 2 Vb Harm[13]
8179	SRC 2 Vb Harmonics	SRC 2 Vb Harm[14]
8180	SRC 2 Vb Harmonics	SRC 2 Vb Harm[15]
8181	SRC 2 Vb Harmonics	SRC 2 Vb Harm[16]
8182	SRC 2 Vb Harmonics	SRC 2 Vb Harm[17]
8183	SRC 2 Vb Harmonics	SRC 2 Vb Harm[18]
8184	SRC 2 Vb Harmonics	SRC 2 Vb Harm[19]
8185	SRC 2 Vb Harmonics	SRC 2 Vb Harm[20]
8186	SRC 2 Vb Harmonics	SRC 2 Vb Harm[21]
8187	SRC 2 Vb Harmonics	SRC 2 Vb Harm[22]
8188	SRC 2 Vb Harmonics	SRC 2 Vb Harm[23]
8189	SRC 2 Vc THD	SRC 2 Vc THD
8190	SRC 2 Vc Harmonics	SRC 2 Vc Harm[0]
8191	SRC 2 Vc Harmonics	SRC 2 Vc Harm[1]
8192	SRC 2 Vc Harmonics	SRC 2 Vc Harm[2]
8193	SRC 2 Vc Harmonics	SRC 2 Vc Harm[3]
8194	SRC 2 Vc Harmonics	SRC 2 Vc Harm[4]
8195	SRC 2 Vc Harmonics	SRC 2 Vc Harm[5]
8196	SRC 2 Vc Harmonics	SRC 2 Vc Harm[6]
8197	SRC 2 Vc Harmonics	SRC 2 Vc Harm[7]
8198	SRC 2 Vc Harmonics	SRC 2 Vc Harm[8]
8199	SRC 2 Vc Harmonics	SRC 2 Vc Harm[9]
8200	SRC 2 Vc Harmonics	SRC 2 Vc Harm[10]
8201	SRC 2 Vc Harmonics	SRC 2 Vc Harm[11]
8202	SRC 2 Vc Harmonics	SRC 2 Vc Harm[12]
8203	SRC 2 Vc Harmonics	SRC 2 Vc Harm[13]
8204	SRC 2 Vc Harmonics	SRC 2 Vc Harm[14]
8205	SRC 2 Vc Harmonics	SRC 2 Vc Harm[15]
8206	SRC 2 Vc Harmonics	SRC 2 Vc Harm[16]
8207	SRC 2 Vc Harmonics	SRC 2 Vc Harm[17]
8208	SRC 2 Vc Harmonics	SRC 2 Vc Harm[18]
8209	SRC 2 Vc Harmonics	SRC 2 Vc Harm[19]
8210	SRC 2 Vc Harmonics	SRC 2 Vc Harm[20]
8211	SRC 2 Vc Harmonics	SRC 2 Vc Harm[21]
8212	SRC 2 Vc Harmonics	SRC 2 Vc Harm[22]
8213	SRC 2 Vc Harmonics	SRC 2 Vc Harm[23]
8214	SRC 3 Va THD	SRC 3 Va THD
8215	SRC 3 Va Harmonics	SRC 3 Va Harm[0]
8216	SRC 3 Va Harmonics	SRC 3 Va Harm[1]
8217	SRC 3 Va Harmonics	SRC 3 Va Harm[2]
8218	SRC 3 Va Harmonics	SRC 3 Va Harm[3]
8219	SRC 3 Va Harmonics	SRC 3 Va Harm[4]
8220	SRC 3 Va Harmonics	SRC 3 Va Harm[5]
8221	SRC 3 Va Harmonics	SRC 3 Va Harm[6]

Table A-1: FLEXANALOG DATA ITEMS (Sheet 10 of 20)

ADDR	DATA ITEM	FLEXANALOG NAME
8222	SRC 3 Va Harmonics	SRC 3 Va Harm[7]
8223	SRC 3 Va Harmonics	SRC 3 Va Harm[8]
8224	SRC 3 Va Harmonics	SRC 3 Va Harm[9]
8225	SRC 3 Va Harmonics	SRC 3 Va Harm[10]
8226	SRC 3 Va Harmonics	SRC 3 Va Harm[11]
8227	SRC 3 Va Harmonics	SRC 3 Va Harm[12]
8228	SRC 3 Va Harmonics	SRC 3 Va Harm[13]
8229	SRC 3 Va Harmonics	SRC 3 Va Harm[14]
8230	SRC 3 Va Harmonics	SRC 3 Va Harm[15]
8231	SRC 3 Va Harmonics	SRC 3 Va Harm[16]
8232	SRC 3 Va Harmonics	SRC 3 Va Harm[17]
8233	SRC 3 Va Harmonics	SRC 3 Va Harm[18]
8234	SRC 3 Va Harmonics	SRC 3 Va Harm[19]
8235	SRC 3 Va Harmonics	SRC 3 Va Harm[20]
8236	SRC 3 Va Harmonics	SRC 3 Va Harm[21]
8237	SRC 3 Va Harmonics	SRC 3 Va Harm[22]
8238	SRC 3 Va Harmonics	SRC 3 Va Harm[23]
8239	SRC 3 Vb THD	SRC 3 Vb THD
8240	SRC 3 Vb Harmonics	SRC 3 Vb Harm[0]
8241	SRC 3 Vb Harmonics	SRC 3 Vb Harm[1]
8242	SRC 3 Vb Harmonics	SRC 3 Vb Harm[2]
8243	SRC 3 Vb Harmonics	SRC 3 Vb Harm[3]
8244	SRC 3 Vb Harmonics	SRC 3 Vb Harm[4]
8245	SRC 3 Vb Harmonics	SRC 3 Vb Harm[5]
8246	SRC 3 Vb Harmonics	SRC 3 Vb Harm[6]
8247	SRC 3 Vb Harmonics	SRC 3 Vb Harm[7]
8248	SRC 3 Vb Harmonics	SRC 3 Vb Harm[8]
8249	SRC 3 Vb Harmonics	SRC 3 Vb Harm[9]
8250	SRC 3 Vb Harmonics	SRC 3 Vb Harm[10]
8251	SRC 3 Vb Harmonics	SRC 3 Vb Harm[11]
8252	SRC 3 Vb Harmonics	SRC 3 Vb Harm[12]
8253	SRC 3 Vb Harmonics	SRC 3 Vb Harm[13]
8254	SRC 3 Vb Harmonics	SRC 3 Vb Harm[14]
8255	SRC 3 Vb Harmonics	SRC 3 Vb Harm[15]
8256	SRC 3 Vb Harmonics	SRC 3 Vb Harm[16]
8257	SRC 3 Vb Harmonics	SRC 3 Vb Harm[17]
8258	SRC 3 Vb Harmonics	SRC 3 Vb Harm[18]
8259	SRC 3 Vb Harmonics	SRC 3 Vb Harm[19]
8260	SRC 3 Vb Harmonics	SRC 3 Vb Harm[20]
8261	SRC 3 Vb Harmonics	SRC 3 Vb Harm[21]
8262	SRC 3 Vb Harmonics	SRC 3 Vb Harm[22]
8263	SRC 3 Vb Harmonics	SRC 3 Vb Harm[23]
8264	SRC 3 Vc THD	SRC 3 Vc THD
8265	SRC 3 Vc Harmonics	SRC 3 Vc Harm[0]
8266	SRC 3 Vc Harmonics	SRC 3 Vc Harm[1]
8267	SRC 3 Vc Harmonics	SRC 3 Vc Harm[2]
8268	SRC 3 Vc Harmonics	SRC 3 Vc Harm[3]
8269	SRC 3 Vc Harmonics	SRC 3 Vc Harm[4]
8270	SRC 3 Vc Harmonics	SRC 3 Vc Harm[5]
8271	SRC 3 Vc Harmonics	SRC 3 Vc Harm[6]
8272	SRC 3 Vc Harmonics	SRC 3 Vc Harm[7]
8273	SRC 3 Vc Harmonics	SRC 3 Vc Harm[8]

A

A

Table A-1: FLEXANALOG DATA ITEMS (Sheet 11 of 20)

ADDR	DATA ITEM	FLEXANALOG NAME
8274	SRC 3 Vc Harmonics	SRC 3 Vc Harm[9]
8275	SRC 3 Vc Harmonics	SRC 3 Vc Harm[10]
8276	SRC 3 Vc Harmonics	SRC 3 Vc Harm[11]
8277	SRC 3 Vc Harmonics	SRC 3 Vc Harm[12]
8278	SRC 3 Vc Harmonics	SRC 3 Vc Harm[13]
8279	SRC 3 Vc Harmonics	SRC 3 Vc Harm[14]
8280	SRC 3 Vc Harmonics	SRC 3 Vc Harm[15]
8281	SRC 3 Vc Harmonics	SRC 3 Vc Harm[16]
8282	SRC 3 Vc Harmonics	SRC 3 Vc Harm[17]
8283	SRC 3 Vc Harmonics	SRC 3 Vc Harm[18]
8284	SRC 3 Vc Harmonics	SRC 3 Vc Harm[19]
8285	SRC 3 Vc Harmonics	SRC 3 Vc Harm[20]
8286	SRC 3 Vc Harmonics	SRC 3 Vc Harm[21]
8287	SRC 3 Vc Harmonics	SRC 3 Vc Harm[22]
8288	SRC 3 Vc Harmonics	SRC 3 Vc Harm[23]
8289	SRC 4 Va THD	SRC 4 Va THD
8290	SRC 4 Va Harmonics	SRC 4 Va Harm[0]
8291	SRC 4 Va Harmonics	SRC 4 Va Harm[1]
8292	SRC 4 Va Harmonics	SRC 4 Va Harm[2]
8293	SRC 4 Va Harmonics	SRC 4 Va Harm[3]
8294	SRC 4 Va Harmonics	SRC 4 Va Harm[4]
8295	SRC 4 Va Harmonics	SRC 4 Va Harm[5]
8296	SRC 4 Va Harmonics	SRC 4 Va Harm[6]
8297	SRC 4 Va Harmonics	SRC 4 Va Harm[7]
8298	SRC 4 Va Harmonics	SRC 4 Va Harm[8]
8299	SRC 4 Va Harmonics	SRC 4 Va Harm[9]
8300	SRC 4 Va Harmonics	SRC 4 Va Harm[10]
8301	SRC 4 Va Harmonics	SRC 4 Va Harm[11]
8302	SRC 4 Va Harmonics	SRC 4 Va Harm[12]
8303	SRC 4 Va Harmonics	SRC 4 Va Harm[13]
8304	SRC 4 Va Harmonics	SRC 4 Va Harm[14]
8305	SRC 4 Va Harmonics	SRC 4 Va Harm[15]
8306	SRC 4 Va Harmonics	SRC 4 Va Harm[16]
8307	SRC 4 Va Harmonics	SRC 4 Va Harm[17]
8308	SRC 4 Va Harmonics	SRC 4 Va Harm[18]
8309	SRC 4 Va Harmonics	SRC 4 Va Harm[19]
8310	SRC 4 Va Harmonics	SRC 4 Va Harm[20]
8311	SRC 4 Va Harmonics	SRC 4 Va Harm[21]
8312	SRC 4 Va Harmonics	SRC 4 Va Harm[22]
8313	SRC 4 Va Harmonics	SRC 4 Va Harm[23]
8314	SRC 4 Vb THD	SRC 4 Vb THD
8315	SRC 4 Vb Harmonics	SRC 4 Vb Harm[0]
8316	SRC 4 Vb Harmonics	SRC 4 Vb Harm[1]
8317	SRC 4 Vb Harmonics	SRC 4 Vb Harm[2]
8318	SRC 4 Vb Harmonics	SRC 4 Vb Harm[3]
8319	SRC 4 Vb Harmonics	SRC 4 Vb Harm[4]
8320	SRC 4 Vb Harmonics	SRC 4 Vb Harm[5]
8321	SRC 4 Vb Harmonics	SRC 4 Vb Harm[6]
8322	SRC 4 Vb Harmonics	SRC 4 Vb Harm[7]
8323	SRC 4 Vb Harmonics	SRC 4 Vb Harm[8]
8324	SRC 4 Vb Harmonics	SRC 4 Vb Harm[9]
8325	SRC 4 Vb Harmonics	SRC 4 Vb Harm[10]

Table A-1: FLEXANALOG DATA ITEMS (Sheet 12 of 20)

ADDR	DATA ITEM	FLEXANALOG NAME
8326	SRC 4 Vb Harmonics	SRC 4 Vb Harm[11]
8327	SRC 4 Vb Harmonics	SRC 4 Vb Harm[12]
8328	SRC 4 Vb Harmonics	SRC 4 Vb Harm[13]
8329	SRC 4 Vb Harmonics	SRC 4 Vb Harm[14]
8330	SRC 4 Vb Harmonics	SRC 4 Vb Harm[15]
8331	SRC 4 Vb Harmonics	SRC 4 Vb Harm[16]
8332	SRC 4 Vb Harmonics	SRC 4 Vb Harm[17]
8333	SRC 4 Vb Harmonics	SRC 4 Vb Harm[18]
8334	SRC 4 Vb Harmonics	SRC 4 Vb Harm[19]
8335	SRC 4 Vb Harmonics	SRC 4 Vb Harm[20]
8336	SRC 4 Vb Harmonics	SRC 4 Vb Harm[21]
8337	SRC 4 Vb Harmonics	SRC 4 Vb Harm[22]
8338	SRC 4 Vb Harmonics	SRC 4 Vb Harm[23]
8339	SRC 4 Vc THD	SRC 4 Vc THD
8340	SRC 4 Vc Harmonics	SRC 4 Vc Harm[0]
8341	SRC 4 Vc Harmonics	SRC 4 Vc Harm[1]
8342	SRC 4 Vc Harmonics	SRC 4 Vc Harm[2]
8343	SRC 4 Vc Harmonics	SRC 4 Vc Harm[3]
8344	SRC 4 Vc Harmonics	SRC 4 Vc Harm[4]
8345	SRC 4 Vc Harmonics	SRC 4 Vc Harm[5]
8346	SRC 4 Vc Harmonics	SRC 4 Vc Harm[6]
8347	SRC 4 Vc Harmonics	SRC 4 Vc Harm[7]
8348	SRC 4 Vc Harmonics	SRC 4 Vc Harm[8]
8349	SRC 4 Vc Harmonics	SRC 4 Vc Harm[9]
8350	SRC 4 Vc Harmonics	SRC 4 Vc Harm[10]
8351	SRC 4 Vc Harmonics	SRC 4 Vc Harm[11]
8352	SRC 4 Vc Harmonics	SRC 4 Vc Harm[12]
8353	SRC 4 Vc Harmonics	SRC 4 Vc Harm[13]
8354	SRC 4 Vc Harmonics	SRC 4 Vc Harm[14]
8355	SRC 4 Vc Harmonics	SRC 4 Vc Harm[15]
8356	SRC 4 Vc Harmonics	SRC 4 Vc Harm[16]
8357	SRC 4 Vc Harmonics	SRC 4 Vc Harm[17]
8358	SRC 4 Vc Harmonics	SRC 4 Vc Harm[18]
8359	SRC 4 Vc Harmonics	SRC 4 Vc Harm[19]
8360	SRC 4 Vc Harmonics	SRC 4 Vc Harm[20]
8361	SRC 4 Vc Harmonics	SRC 4 Vc Harm[21]
8362	SRC 4 Vc Harmonics	SRC 4 Vc Harm[22]
8363	SRC 4 Vc Harmonics	SRC 4 Vc Harm[23]
8960	Transformer Reference Winding	Xfmr Ref Winding
8961	Transformer Diff. Phasor Iad Mag.	Xfmr Iad Mag
8962	Transformer Diff. Phasor Iad Angle	Xfmr Iad Angle
8963	Transformer Restraint Phsr. Iar Mag.	Xfmr Iar Mag
8964	Transformer Restraint Phsr. Iar Angle	Xfmr Iar Angle
8965	Transformer Diff. 2nd Harm Iad Mag.	Xfmr Harm2 Iad Mag
8966	Transformer Diff. 2nd Harm Iad Angle	Xfmr Harm2 Iad Angle
8967	Transformer Diff. 5th Harm Iad Mag.	Xfmr Harm5 Iad Mag
8968	Transformer Diff. 5th Harm Iad Angle	Xfmr Harm5 Iad Angle
8969	Transformer Diff. Phasor Ibd Mag.	Xfmr Ibd Mag
8970	Transformer Diff. Phasor Ibd Angle	Xfmr Ibd Angle
8971	Transformer Restraint Phsr. Ibr Mag.	Xfmr Ibr Mag
8972	Transformer Restraint Phsr. Ibr Angle	Xfmr Ibr Angle
8973	Transformer Diff. 2nd Harm Ibd Mag.	Xfmr Harm2 Ibd Mag

Table A-1: FLEXANALOG DATA ITEMS (Sheet 13 of 20)

ADDR	DATA ITEM	FLEXANALOG NAME
8974	Transformer Diff. 2nd Harm lbd Angle	Xfmr Harm2 lbd Angle
8975	Transformer Diff. 5th Harm lbd Mag.	Xfmr Harm5 lbd Mag
8976	Transformer Diff. 5th Harm lbd Angle	Xfmr Harm5 lbd Angle
8977	Transformer Diff. Phasor lcd Mag.	Xfmr lcd Mag
8978	Transformer Diff. Phasor lcd Angle	Xfmr lcd Angle
8979	Transformer Restraint Phasor lcr Mag	Xfmr lcr Mag
8980	Transformer Restraint Phsr. lcr Angle	Xfmr lcr Angle
8981	Transformer Diff. 2nd Harm lcd Mag.	Xfmr Harm2 lcd Mag
8982	Transformer Diff. 2nd Harm lcd Angle	Xfmr Harm2 lcd Angle
8983	Transformer Diff. 5th Harm lcd Mag.	Xfmr Harm5 lcd Mag
8984	Transformer Diff. 5th Harm lcd Angle	Xfmr Harm5 lcd Angle
9008	Transformer Top Oil Temperature	Xfmr top-oil t° C
9009	Trans. Hottest Spot Temperature	Xfmr hst-spot t° C
9010	Transformer Aging Factor	Xfmr agng fctr
9011	Transformer Daily Loss Of Life	Xfmr daily LOL
9013	Transformer Accumulated Loss Of Life	Xfmr acc LOL
10240	SRC 1 la THD	SRC 1 la THD
10241	SRC 1 la Harmonics	SRC 1 la Harm[0]
10242	SRC 1 la Harmonics	SRC 1 la Harm[1]
10243	SRC 1 la Harmonics	SRC 1 la Harm[2]
10244	SRC 1 la Harmonics	SRC 1 la Harm[3]
10245	SRC 1 la Harmonics	SRC 1 la Harm[4]
10246	SRC 1 la Harmonics	SRC 1 la Harm[5]
10247	SRC 1 la Harmonics	SRC 1 la Harm[6]
10248	SRC 1 la Harmonics	SRC 1 la Harm[7]
10249	SRC 1 la Harmonics	SRC 1 la Harm[8]
10250	SRC 1 la Harmonics	SRC 1 la Harm[9]
10251	SRC 1 la Harmonics	SRC 1 la Harm[10]
10252	SRC 1 la Harmonics	SRC 1 la Harm[11]
10253	SRC 1 la Harmonics	SRC 1 la Harm[12]
10254	SRC 1 la Harmonics	SRC 1 la Harm[13]
10255	SRC 1 la Harmonics	SRC 1 la Harm[14]
10256	SRC 1 la Harmonics	SRC 1 la Harm[15]
10257	SRC 1 la Harmonics	SRC 1 la Harm[16]
10258	SRC 1 la Harmonics	SRC 1 la Harm[17]
10259	SRC 1 la Harmonics	SRC 1 la Harm[18]
10260	SRC 1 la Harmonics	SRC 1 la Harm[19]
10261	SRC 1 la Harmonics	SRC 1 la Harm[20]
10262	SRC 1 la Harmonics	SRC 1 la Harm[21]
10263	SRC 1 la Harmonics	SRC 1 la Harm[22]
10264	SRC 1 la Harmonics	SRC 1 la Harm[23]
10273	SRC 1 lb THD	SRC 1 lb THD
10274	SRC 1 lb Harmonics	SRC 1 lb Harm[0]
10275	SRC 1 lb Harmonics	SRC 1 lb Harm[1]
10276	SRC 1 lb Harmonics	SRC 1 lb Harm[2]
10277	SRC 1 lb Harmonics	SRC 1 lb Harm[3]
10278	SRC 1 lb Harmonics	SRC 1 lb Harm[4]
10279	SRC 1 lb Harmonics	SRC 1 lb Harm[5]
10280	SRC 1 lb Harmonics	SRC 1 lb Harm[6]
10281	SRC 1 lb Harmonics	SRC 1 lb Harm[7]
10282	SRC 1 lb Harmonics	SRC 1 lb Harm[8]

Table A-1: FLEXANALOG DATA ITEMS (Sheet 14 of 20)

ADDR	DATA ITEM	FLEXANALOG NAME
10283	SRC 1 lb Harmonics	SRC 1 lb Harm[9]
10284	SRC 1 lb Harmonics	SRC 1 lb Harm[10]
10285	SRC 1 lb Harmonics	SRC 1 lb Harm[11]
10286	SRC 1 lb Harmonics	SRC 1 lb Harm[12]
10287	SRC 1 lb Harmonics	SRC 1 lb Harm[13]
10288	SRC 1 lb Harmonics	SRC 1 lb Harm[14]
10289	SRC 1 lb Harmonics	SRC 1 lb Harm[15]
10290	SRC 1 lb Harmonics	SRC 1 lb Harm[16]
10291	SRC 1 lb Harmonics	SRC 1 lb Harm[17]
10292	SRC 1 lb Harmonics	SRC 1 lb Harm[18]
10293	SRC 1 lb Harmonics	SRC 1 lb Harm[19]
10294	SRC 1 lb Harmonics	SRC 1 lb Harm[20]
10295	SRC 1 lb Harmonics	SRC 1 lb Harm[21]
10296	SRC 1 lb Harmonics	SRC 1 lb Harm[22]
10297	SRC 1 lb Harmonics	SRC 1 lb Harm[23]
10306	SRC 1 lc THD	SRC 1 lc THD
10307	SRC 1 lc Harmonics	SRC 1 lc Harm[0]
10308	SRC 1 lc Harmonics	SRC 1 lc Harm[1]
10309	SRC 1 lc Harmonics	SRC 1 lc Harm[2]
10310	SRC 1 lc Harmonics	SRC 1 lc Harm[3]
10311	SRC 1 lc Harmonics	SRC 1 lc Harm[4]
10312	SRC 1 lc Harmonics	SRC 1 lc Harm[5]
10313	SRC 1 lc Harmonics	SRC 1 lc Harm[6]
10314	SRC 1 lc Harmonics	SRC 1 lc Harm[7]
10315	SRC 1 lc Harmonics	SRC 1 lc Harm[8]
10316	SRC 1 lc Harmonics	SRC 1 lc Harm[9]
10317	SRC 1 lc Harmonics	SRC 1 lc Harm[10]
10318	SRC 1 lc Harmonics	SRC 1 lc Harm[11]
10319	SRC 1 lc Harmonics	SRC 1 lc Harm[12]
10320	SRC 1 lc Harmonics	SRC 1 lc Harm[13]
10321	SRC 1 lc Harmonics	SRC 1 lc Harm[14]
10322	SRC 1 lc Harmonics	SRC 1 lc Harm[15]
10323	SRC 1 lc Harmonics	SRC 1 lc Harm[16]
10324	SRC 1 lc Harmonics	SRC 1 lc Harm[17]
10325	SRC 1 lc Harmonics	SRC 1 lc Harm[18]
10326	SRC 1 lc Harmonics	SRC 1 lc Harm[19]
10327	SRC 1 lc Harmonics	SRC 1 lc Harm[20]
10328	SRC 1 lc Harmonics	SRC 1 lc Harm[21]
10329	SRC 1 lc Harmonics	SRC 1 lc Harm[22]
10330	SRC 1 lc Harmonics	SRC 1 lc Harm[23]
10339	SRC 2 la THD	SRC 2 la THD
10340	SRC 2 la Harmonics	SRC 2 la Harm[0]
10341	SRC 2 la Harmonics	SRC 2 la Harm[1]
10342	SRC 2 la Harmonics	SRC 2 la Harm[2]
10343	SRC 2 la Harmonics	SRC 2 la Harm[3]
10344	SRC 2 la Harmonics	SRC 2 la Harm[4]
10345	SRC 2 la Harmonics	SRC 2 la Harm[5]
10346	SRC 2 la Harmonics	SRC 2 la Harm[6]
10347	SRC 2 la Harmonics	SRC 2 la Harm[7]
10348	SRC 2 la Harmonics	SRC 2 la Harm[8]
10349	SRC 2 la Harmonics	SRC 2 la Harm[9]
10350	SRC 2 la Harmonics	SRC 2 la Harm[10]

A

A

Table A-1: FLEXANALOG DATA ITEMS (Sheet 15 of 20)

ADDR	DATA ITEM	FLEXANALOG NAME
10351	SRC 2 Ia Harmonics	SRC 2 Ia Harm[11]
10352	SRC 2 Ia Harmonics	SRC 2 Ia Harm[12]
10353	SRC 2 Ia Harmonics	SRC 2 Ia Harm[13]
10354	SRC 2 Ia Harmonics	SRC 2 Ia Harm[14]
10355	SRC 2 Ia Harmonics	SRC 2 Ia Harm[15]
10356	SRC 2 Ia Harmonics	SRC 2 Ia Harm[16]
10357	SRC 2 Ia Harmonics	SRC 2 Ia Harm[17]
10358	SRC 2 Ia Harmonics	SRC 2 Ia Harm[18]
10359	SRC 2 Ia Harmonics	SRC 2 Ia Harm[19]
10360	SRC 2 Ia Harmonics	SRC 2 Ia Harm[20]
10361	SRC 2 Ia Harmonics	SRC 2 Ia Harm[21]
10362	SRC 2 Ia Harmonics	SRC 2 Ia Harm[22]
10363	SRC 2 Ia Harmonics	SRC 2 Ia Harm[23]
10372	SRC 2 Ib THD	SRC 2 Ib THD
10373	SRC 2 Ib Harmonics	SRC 2 Ib Harm[0]
10374	SRC 2 Ib Harmonics	SRC 2 Ib Harm[1]
10375	SRC 2 Ib Harmonics	SRC 2 Ib Harm[2]
10376	SRC 2 Ib Harmonics	SRC 2 Ib Harm[3]
10377	SRC 2 Ib Harmonics	SRC 2 Ib Harm[4]
10378	SRC 2 Ib Harmonics	SRC 2 Ib Harm[5]
10379	SRC 2 Ib Harmonics	SRC 2 Ib Harm[6]
10380	SRC 2 Ib Harmonics	SRC 2 Ib Harm[7]
10381	SRC 2 Ib Harmonics	SRC 2 Ib Harm[8]
10382	SRC 2 Ib Harmonics	SRC 2 Ib Harm[9]
10383	SRC 2 Ib Harmonics	SRC 2 Ib Harm[10]
10384	SRC 2 Ib Harmonics	SRC 2 Ib Harm[11]
10385	SRC 2 Ib Harmonics	SRC 2 Ib Harm[12]
10386	SRC 2 Ib Harmonics	SRC 2 Ib Harm[13]
10387	SRC 2 Ib Harmonics	SRC 2 Ib Harm[14]
10388	SRC 2 Ib Harmonics	SRC 2 Ib Harm[15]
10389	SRC 2 Ib Harmonics	SRC 2 Ib Harm[16]
10390	SRC 2 Ib Harmonics	SRC 2 Ib Harm[17]
10391	SRC 2 Ib Harmonics	SRC 2 Ib Harm[18]
10392	SRC 2 Ib Harmonics	SRC 2 Ib Harm[19]
10393	SRC 2 Ib Harmonics	SRC 2 Ib Harm[20]
10394	SRC 2 Ib Harmonics	SRC 2 Ib Harm[21]
10395	SRC 2 Ib Harmonics	SRC 2 Ib Harm[22]
10396	SRC 2 Ib Harmonics	SRC 2 Ib Harm[23]
10405	SRC 2 Ic THD	SRC 2 Ic THD
10406	SRC 2 Ic Harmonics	SRC 2 Ic Harm[0]
10407	SRC 2 Ic Harmonics	SRC 2 Ic Harm[1]
10408	SRC 2 Ic Harmonics	SRC 2 Ic Harm[2]
10409	SRC 2 Ic Harmonics	SRC 2 Ic Harm[3]
10410	SRC 2 Ic Harmonics	SRC 2 Ic Harm[4]
10411	SRC 2 Ic Harmonics	SRC 2 Ic Harm[5]
10412	SRC 2 Ic Harmonics	SRC 2 Ic Harm[6]
10413	SRC 2 Ic Harmonics	SRC 2 Ic Harm[7]
10414	SRC 2 Ic Harmonics	SRC 2 Ic Harm[8]
10415	SRC 2 Ic Harmonics	SRC 2 Ic Harm[9]
10416	SRC 2 Ic Harmonics	SRC 2 Ic Harm[10]
10417	SRC 2 Ic Harmonics	SRC 2 Ic Harm[11]
10418	SRC 2 Ic Harmonics	SRC 2 Ic Harm[12]

Table A-1: FLEXANALOG DATA ITEMS (Sheet 16 of 20)

ADDR	DATA ITEM	FLEXANALOG NAME
10419	SRC 2 Ic Harmonics	SRC 2 Ic Harm[13]
10420	SRC 2 Ic Harmonics	SRC 2 Ic Harm[14]
10421	SRC 2 Ic Harmonics	SRC 2 Ic Harm[15]
10422	SRC 2 Ic Harmonics	SRC 2 Ic Harm[16]
10423	SRC 2 Ic Harmonics	SRC 2 Ic Harm[17]
10424	SRC 2 Ic Harmonics	SRC 2 Ic Harm[18]
10425	SRC 2 Ic Harmonics	SRC 2 Ic Harm[19]
10426	SRC 2 Ic Harmonics	SRC 2 Ic Harm[20]
10427	SRC 2 Ic Harmonics	SRC 2 Ic Harm[21]
10428	SRC 2 Ic Harmonics	SRC 2 Ic Harm[22]
10429	SRC 2 Ic Harmonics	SRC 2 Ic Harm[23]
10438	SRC 3 Ia THD	SRC 3 Ia THD
10439	SRC 3 Ia Harmonics	SRC 3 Ia Harm[0]
10440	SRC 3 Ia Harmonics	SRC 3 Ia Harm[1]
10441	SRC 3 Ia Harmonics	SRC 3 Ia Harm[2]
10442	SRC 3 Ia Harmonics	SRC 3 Ia Harm[3]
10443	SRC 3 Ia Harmonics	SRC 3 Ia Harm[4]
10444	SRC 3 Ia Harmonics	SRC 3 Ia Harm[5]
10445	SRC 3 Ia Harmonics	SRC 3 Ia Harm[6]
10446	SRC 3 Ia Harmonics	SRC 3 Ia Harm[7]
10447	SRC 3 Ia Harmonics	SRC 3 Ia Harm[8]
10448	SRC 3 Ia Harmonics	SRC 3 Ia Harm[9]
10449	SRC 3 Ia Harmonics	SRC 3 Ia Harm[10]
10450	SRC 3 Ia Harmonics	SRC 3 Ia Harm[11]
10451	SRC 3 Ia Harmonics	SRC 3 Ia Harm[12]
10452	SRC 3 Ia Harmonics	SRC 3 Ia Harm[13]
10453	SRC 3 Ia Harmonics	SRC 3 Ia Harm[14]
10454	SRC 3 Ia Harmonics	SRC 3 Ia Harm[15]
10455	SRC 3 Ia Harmonics	SRC 3 Ia Harm[16]
10456	SRC 3 Ia Harmonics	SRC 3 Ia Harm[17]
10457	SRC 3 Ia Harmonics	SRC 3 Ia Harm[18]
10458	SRC 3 Ia Harmonics	SRC 3 Ia Harm[19]
10459	SRC 3 Ia Harmonics	SRC 3 Ia Harm[20]
10460	SRC 3 Ia Harmonics	SRC 3 Ia Harm[21]
10461	SRC 3 Ia Harmonics	SRC 3 Ia Harm[22]
10462	SRC 3 Ia Harmonics	SRC 3 Ia Harm[23]
10471	SRC 3 Ib THD	SRC 3 Ib THD
10472	SRC 3 Ib Harmonics	SRC 3 Ib Harm[0]
10473	SRC 3 Ib Harmonics	SRC 3 Ib Harm[1]
10474	SRC 3 Ib Harmonics	SRC 3 Ib Harm[2]
10475	SRC 3 Ib Harmonics	SRC 3 Ib Harm[3]
10476	SRC 3 Ib Harmonics	SRC 3 Ib Harm[4]
10477	SRC 3 Ib Harmonics	SRC 3 Ib Harm[5]
10478	SRC 3 Ib Harmonics	SRC 3 Ib Harm[6]
10479	SRC 3 Ib Harmonics	SRC 3 Ib Harm[7]
10480	SRC 3 Ib Harmonics	SRC 3 Ib Harm[8]
10481	SRC 3 Ib Harmonics	SRC 3 Ib Harm[9]
10482	SRC 3 Ib Harmonics	SRC 3 Ib Harm[10]
10483	SRC 3 Ib Harmonics	SRC 3 Ib Harm[11]
10484	SRC 3 Ib Harmonics	SRC 3 Ib Harm[12]
10485	SRC 3 Ib Harmonics	SRC 3 Ib Harm[13]
10486	SRC 3 Ib Harmonics	SRC 3 Ib Harm[14]

Table A-1: FLEXANALOG DATA ITEMS (Sheet 17 of 20)

ADDR	DATA ITEM	FLEXANALOG NAME
10487	SRC 3 lb Harmonics	SRC 3 lb Harm[15]
10488	SRC 3 lb Harmonics	SRC 3 lb Harm[16]
10489	SRC 3 lb Harmonics	SRC 3 lb Harm[17]
10490	SRC 3 lb Harmonics	SRC 3 lb Harm[18]
10491	SRC 3 lb Harmonics	SRC 3 lb Harm[19]
10492	SRC 3 lb Harmonics	SRC 3 lb Harm[20]
10493	SRC 3 lb Harmonics	SRC 3 lb Harm[21]
10494	SRC 3 lb Harmonics	SRC 3 lb Harm[22]
10495	SRC 3 lb Harmonics	SRC 3 lb Harm[23]
10504	SRC 3 lc THD	SRC 3 lc THD
10505	SRC 3 lc Harmonics	SRC 3 lc Harm[0]
10506	SRC 3 lc Harmonics	SRC 3 lc Harm[1]
10507	SRC 3 lc Harmonics	SRC 3 lc Harm[2]
10508	SRC 3 lc Harmonics	SRC 3 lc Harm[3]
10509	SRC 3 lc Harmonics	SRC 3 lc Harm[4]
10510	SRC 3 lc Harmonics	SRC 3 lc Harm[5]
10511	SRC 3 lc Harmonics	SRC 3 lc Harm[6]
10512	SRC 3 lc Harmonics	SRC 3 lc Harm[7]
10513	SRC 3 lc Harmonics	SRC 3 lc Harm[8]
10514	SRC 3 lc Harmonics	SRC 3 lc Harm[9]
10515	SRC 3 lc Harmonics	SRC 3 lc Harm[10]
10516	SRC 3 lc Harmonics	SRC 3 lc Harm[11]
10517	SRC 3 lc Harmonics	SRC 3 lc Harm[12]
10518	SRC 3 lc Harmonics	SRC 3 lc Harm[13]
10519	SRC 3 lc Harmonics	SRC 3 lc Harm[14]
10520	SRC 3 lc Harmonics	SRC 3 lc Harm[15]
10521	SRC 3 lc Harmonics	SRC 3 lc Harm[16]
10522	SRC 3 lc Harmonics	SRC 3 lc Harm[17]
10523	SRC 3 lc Harmonics	SRC 3 lc Harm[18]
10524	SRC 3 lc Harmonics	SRC 3 lc Harm[19]
10525	SRC 3 lc Harmonics	SRC 3 lc Harm[20]
10526	SRC 3 lc Harmonics	SRC 3 lc Harm[21]
10527	SRC 3 lc Harmonics	SRC 3 lc Harm[22]
10528	SRC 3 lc Harmonics	SRC 3 lc Harm[23]
10537	SRC 4 la THD	SRC 4 la THD
10538	SRC 4 la Harmonics	SRC 4 la Harm[0]
10539	SRC 4 la Harmonics	SRC 4 la Harm[1]
10540	SRC 4 la Harmonics	SRC 4 la Harm[2]
10541	SRC 4 la Harmonics	SRC 4 la Harm[3]
10542	SRC 4 la Harmonics	SRC 4 la Harm[4]
10543	SRC 4 la Harmonics	SRC 4 la Harm[5]
10544	SRC 4 la Harmonics	SRC 4 la Harm[6]
10545	SRC 4 la Harmonics	SRC 4 la Harm[7]
10546	SRC 4 la Harmonics	SRC 4 la Harm[8]
10547	SRC 4 la Harmonics	SRC 4 la Harm[9]
10548	SRC 4 la Harmonics	SRC 4 la Harm[10]
10549	SRC 4 la Harmonics	SRC 4 la Harm[11]
10550	SRC 4 la Harmonics	SRC 4 la Harm[12]
10551	SRC 4 la Harmonics	SRC 4 la Harm[13]
10552	SRC 4 la Harmonics	SRC 4 la Harm[14]
10553	SRC 4 la Harmonics	SRC 4 la Harm[15]
10554	SRC 4 la Harmonics	SRC 4 la Harm[16]

Table A-1: FLEXANALOG DATA ITEMS (Sheet 18 of 20)

ADDR	DATA ITEM	FLEXANALOG NAME
10555	SRC 4 la Harmonics	SRC 4 la Harm[17]
10556	SRC 4 la Harmonics	SRC 4 la Harm[18]
10557	SRC 4 la Harmonics	SRC 4 la Harm[19]
10558	SRC 4 la Harmonics	SRC 4 la Harm[20]
10559	SRC 4 la Harmonics	SRC 4 la Harm[21]
10560	SRC 4 la Harmonics	SRC 4 la Harm[22]
10561	SRC 4 la Harmonics	SRC 4 la Harm[23]
10570	SRC 4 lb THD	SRC 4 lb THD
10571	SRC 4 lb Harmonics	SRC 4 lb Harm[0]
10572	SRC 4 lb Harmonics	SRC 4 lb Harm[1]
10573	SRC 4 lb Harmonics	SRC 4 lb Harm[2]
10574	SRC 4 lb Harmonics	SRC 4 lb Harm[3]
10575	SRC 4 lb Harmonics	SRC 4 lb Harm[4]
10576	SRC 4 lb Harmonics	SRC 4 lb Harm[5]
10577	SRC 4 lb Harmonics	SRC 4 lb Harm[6]
10578	SRC 4 lb Harmonics	SRC 4 lb Harm[7]
10579	SRC 4 lb Harmonics	SRC 4 lb Harm[8]
10580	SRC 4 lb Harmonics	SRC 4 lb Harm[9]
10581	SRC 4 lb Harmonics	SRC 4 lb Harm[10]
10582	SRC 4 lb Harmonics	SRC 4 lb Harm[11]
10583	SRC 4 lb Harmonics	SRC 4 lb Harm[12]
10584	SRC 4 lb Harmonics	SRC 4 lb Harm[13]
10585	SRC 4 lb Harmonics	SRC 4 lb Harm[14]
10586	SRC 4 lb Harmonics	SRC 4 lb Harm[15]
10587	SRC 4 lb Harmonics	SRC 4 lb Harm[16]
10588	SRC 4 lb Harmonics	SRC 4 lb Harm[17]
10589	SRC 4 lb Harmonics	SRC 4 lb Harm[18]
10590	SRC 4 lb Harmonics	SRC 4 lb Harm[19]
10591	SRC 4 lb Harmonics	SRC 4 lb Harm[20]
10592	SRC 4 lb Harmonics	SRC 4 lb Harm[21]
10593	SRC 4 lb Harmonics	SRC 4 lb Harm[22]
10594	SRC 4 lb Harmonics	SRC 4 lb Harm[23]
10603	SRC 4 lc THD	SRC 4 lc THD
10604	SRC 4 lc Harmonics	SRC 4 lc Harm[0]
10605	SRC 4 lc Harmonics	SRC 4 lc Harm[1]
10606	SRC 4 lc Harmonics	SRC 4 lc Harm[2]
10607	SRC 4 lc Harmonics	SRC 4 lc Harm[3]
10608	SRC 4 lc Harmonics	SRC 4 lc Harm[4]
10609	SRC 4 lc Harmonics	SRC 4 lc Harm[5]
10610	SRC 4 lc Harmonics	SRC 4 lc Harm[6]
10611	SRC 4 lc Harmonics	SRC 4 lc Harm[7]
10612	SRC 4 lc Harmonics	SRC 4 lc Harm[8]
10613	SRC 4 lc Harmonics	SRC 4 lc Harm[9]
10614	SRC 4 lc Harmonics	SRC 4 lc Harm[10]
10615	SRC 4 lc Harmonics	SRC 4 lc Harm[11]
10616	SRC 4 lc Harmonics	SRC 4 lc Harm[12]
10617	SRC 4 lc Harmonics	SRC 4 lc Harm[13]
10618	SRC 4 lc Harmonics	SRC 4 lc Harm[14]
10619	SRC 4 lc Harmonics	SRC 4 lc Harm[15]
10620	SRC 4 lc Harmonics	SRC 4 lc Harm[16]
10621	SRC 4 lc Harmonics	SRC 4 lc Harm[17]
10622	SRC 4 lc Harmonics	SRC 4 lc Harm[18]

A

A

Table A-1: FLEXANALOG DATA ITEMS (Sheet 19 of 20)

ADDR	DATA ITEM	FLEXANALOG NAME
10623	SRC 4 Ic Harmonics	SRC 4 Ic Harm[19]
10624	SRC 4 Ic Harmonics	SRC 4 Ic Harm[20]
10625	SRC 4 Ic Harmonics	SRC 4 Ic Harm[21]
10626	SRC 4 Ic Harmonics	SRC 4 Ic Harm[22]
10627	SRC 4 Ic Harmonics	SRC 4 Ic Harm[23]
13504	DCMA Inputs 1 Value	DCMA Inputs 1 Value
13506	DCMA Inputs 2 Value	DCMA Inputs 2 Value
13508	DCMA Inputs 3 Value	DCMA Inputs 3 Value
13510	DCMA Inputs 4 Value	DCMA Inputs 4 Value
13512	DCMA Inputs 5 Value	DCMA Inputs 5 Value
13514	DCMA Inputs 6 Value	DCMA Inputs 6 Value
13516	DCMA Inputs 7 Value	DCMA Inputs 7 Value
13518	DCMA Inputs 8 Value	DCMA Inputs 8 Value
13520	DCMA Inputs 9 Value	DCMA Inputs 9 Value
13522	DCMA Inputs 10 Value	DCMA Inputs 10 Value
13524	DCMA Inputs 11 Value	DCMA Inputs 11 Value
13526	DCMA Inputs 12 Value	DCMA Inputs 12 Value
13528	DCMA Inputs 13 Value	DCMA Inputs 13 Value
13530	DCMA Inputs 14 Value	DCMA Inputs 14 Value
13532	DCMA Inputs 15 Value	DCMA Inputs 15 Value
13534	DCMA Inputs 16 Value	DCMA Inputs 16 Value
13536	DCMA Inputs 17 Value	DCMA Inputs 17 Value
13538	DCMA Inputs 18 Value	DCMA Inputs 18 Value
13540	DCMA Inputs 19 Value	DCMA Inputs 19 Value
13542	DCMA Inputs 20 Value	DCMA Inputs 20 Value
13544	DCMA Inputs 21 Value	DCMA Inputs 21 Value
13546	DCMA Inputs 22 Value	DCMA Inputs 22 Value
13548	DCMA Inputs 23 Value	DCMA Inputs 23 Value
13550	DCMA Inputs 24 Value	DCMA Inputs 24 Value
13552	RTD Inputs 1 Value	RTD Inputs 1 Value
13553	RTD Inputs 2 Value	RTD Inputs 2 Value
13554	RTD Inputs 3 Value	RTD Inputs 3 Value
13555	RTD Inputs 4 Value	RTD Inputs 4 Value
13556	RTD Inputs 5 Value	RTD Inputs 5 Value
13557	RTD Inputs 6 Value	RTD Inputs 6 Value
13558	RTD Inputs 7 Value	RTD Inputs 7 Value
13559	RTD Inputs 8 Value	RTD Inputs 8 Value
13560	RTD Inputs 9 Value	RTD Inputs 9 Value
13561	RTD Inputs 10 Value	RTD Inputs 10 Value
13562	RTD Inputs 11 Value	RTD Inputs 11 Value
13563	RTD Inputs 12 Value	RTD Inputs 12 Value
13564	RTD Inputs 13 Value	RTD Inputs 13 Value
13565	RTD Inputs 14 Value	RTD Inputs 14 Value
13566	RTD Inputs 15 Value	RTD Inputs 15 Value
13567	RTD Inputs 16 Value	RTD Inputs 16 Value
13568	RTD Inputs 17 Value	RTD Inputs 17 Value
13569	RTD Inputs 18 Value	RTD Inputs 18 Value
13570	RTD Inputs 19 Value	RTD Inputs 19 Value
13571	RTD Inputs 20 Value	RTD Inputs 20 Value
13572	RTD Inputs 21 Value	RTD Inputs 21 Value
13573	RTD Inputs 22 Value	RTD Inputs 22 Value
13574	RTD Inputs 23 Value	RTD Inputs 23 Value

Table A-1: FLEXANALOG DATA ITEMS (Sheet 20 of 20)

ADDR	DATA ITEM	FLEXANALOG NAME
13575	RTD Inputs 24 Value	RTD Inputs 24 Value
13576	RTD Inputs 25 Value	RTD Inputs 25 Value
13577	RTD Inputs 26 Value	RTD Inputs 26 Value
13578	RTD Inputs 27 Value	RTD Inputs 27 Value
13579	RTD Inputs 28 Value	RTD Inputs 28 Value
13580	RTD Inputs 29 Value	RTD Inputs 29 Value
13581	RTD Inputs 30 Value	RTD Inputs 30 Value
13582	RTD Inputs 31 Value	RTD Inputs 31 Value
13583	RTD Inputs 32 Value	RTD Inputs 32 Value
13584	RTD Inputs 33 Value	RTD Inputs 33 Value
13585	RTD Inputs 34 Value	RTD Inputs 34 Value
13586	RTD Inputs 35 Value	RTD Inputs 35 Value
13587	RTD Inputs 36 Value	RTD Inputs 36 Value
13588	RTD Inputs 37 Value	RTD Inputs 37 Value
13589	RTD Inputs 38 Value	RTD Inputs 38 Value
13590	RTD Inputs 39 Value	RTD Inputs 39 Value
13591	RTD Inputs 40 Value	RTD Inputs 40 Value
13592	RTD Inputs 41 Value	RTD Inputs 41 Value
13593	RTD Inputs 42 Value	RTD Inputs 42 Value
13594	RTD Inputs 43 Value	RTD Inputs 43 Value
13595	RTD Inputs 44 Value	RTD Inputs 44 Value
13596	RTD Inputs 45 Value	RTD Inputs 45 Value
13597	RTD Inputs 46 Value	RTD Inputs 46 Value
13598	RTD Inputs 47 Value	RTD Inputs 47 Value
13599	RTD Inputs 48 Value	RTD Inputs 48 Value
32768	Tracking Frequency	Tracking Frequency
39425	FlexElement 1 Actual	FlexElement 1 Value
39427	FlexElement 2 Actual	FlexElement 2 Value
39429	FlexElement 3 Actual	FlexElement 3 Value
39431	FlexElement 4 Actual	FlexElement 4 Value
39433	FlexElement 5 Actual	FlexElement 5 Value
39435	FlexElement 6 Actual	FlexElement 6 Value
39437	FlexElement 7 Actual	FlexElement 7 Value
39439	FlexElement 8 Actual	FlexElement 8 Value
39441	FlexElement 9 Actual	FlexElement 9 Value
39443	FlexElement 10 Actual	FlexElement 10 Value
39445	FlexElement 11 Actual	FlexElement 11 Value
39447	FlexElement 12 Actual	FlexElement 12 Value
39449	FlexElement 13 Actual	FlexElement 13 Value
39451	FlexElement 14 Actual	FlexElement 14 Value
39453	FlexElement 15 Actual	FlexElement 15 Value
39455	FlexElement 16 Actual	FlexElement 16 Value
40971	Current Setting Group	Active Setting Group
43808	VHZ 1 Actual	Volts Per Hertz 1
43809	VHZ 2 Actual	Volts Per Hertz 2

B.1.1 INTRODUCTION

The UR-series relays support a number of communications protocols to allow connection to equipment such as personal computers, RTUs, SCADA masters, and programmable logic controllers. The Modicon Modbus RTU protocol is the most basic protocol supported by the UR. Modbus is available via RS232 or RS485 serial links or via ethernet (using the Modbus/TCP specification). The following description is intended primarily for users who wish to develop their own master communication drivers and applies to the serial Modbus RTU protocol. Note that:

- The UR always acts as a slave device, meaning that it never initiates communications; it only listens and responds to requests issued by a master computer.
- For Modbus[®], a subset of the Remote Terminal Unit (RTU) protocol format is supported that allows extensive monitoring, programming, and control functions using read and write register commands.

B.1.2 PHYSICAL LAYER

The Modbus[®] RTU protocol is hardware-independent so that the physical layer can be any of a variety of standard hardware configurations including RS232 and RS485. The relay includes a faceplate (front panel) RS232 port and two rear terminal communications ports that may be configured as RS485, fiber optic, 10BaseT, or 10BaseF. Data flow is half-duplex in all configurations. See Chapter 3 for details on wiring.

Each data byte is transmitted in an asynchronous format consisting of 1 start bit, 8 data bits, 1 stop bit, and possibly 1 parity bit. This produces a 10 or 11 bit data frame. This can be important for transmission through modems at high bit rates (11 bit data frames are not supported by many modems at baud rates greater than 300).

The baud rate and parity are independently programmable for each communications port. Baud rates of 300, 1200, 2400, 4800, 9600, 14400, 19200, 28800, 33600, 38400, 57600, or 115200 bps are available. Even, odd, and no parity are available. Refer to the *Communications* section of Chapter 5 for further details.

The master device in any system must know the address of the slave device with which it is to communicate. The relay will not act on a request from a master if the address in the request does not match the relay's slave address (unless the address is the broadcast address – see below).

A single setting selects the slave address used for all ports, with the exception that for the faceplate port, the relay will accept any address when the Modbus[®] RTU protocol is used.

B.1.3 DATA LINK LAYER

Communications takes place in packets which are groups of asynchronously framed byte data. The master transmits a packet to the slave and the slave responds with a packet. The end of a packet is marked by 'dead-time' on the communications line. The following describes general format for both transmit and receive packets. For exact details on packet formatting, refer to subsequent sections describing each function code.

Table B-1: MODBUS PACKET FORMAT

DESCRIPTION	SIZE
SLAVE ADDRESS	1 byte
FUNCTION CODE	1 byte
DATA	N bytes
CRC	2 bytes
DEAD TIME	3.5 bytes transmission time

- **SLAVE ADDRESS:** This is the address of the slave device that is intended to receive the packet sent by the master and to perform the desired action. Each slave device on a communications bus must have a unique address to prevent bus contention. All of the relay's ports have the same address which is programmable from 1 to 254; see Chapter 5 for details. Only the addressed slave will respond to a packet that starts with its address. Note that the faceplate port is an exception to this rule; it will act on a message containing any slave address.

A master transmit packet with slave address 0 indicates a broadcast command. All slaves on the communication link take action based on the packet, but none respond to the master. Broadcast mode is only recognized when associated with Function Code 05h. For any other function code, a packet with broadcast mode slave address 0 will be ignored.

- **FUNCTION CODE:** This is one of the supported functions codes of the unit which tells the slave what action to perform. See the Supported Function Codes section for complete details. An exception response from the slave is indicated by setting the high order bit of the function code in the response packet. See the Exception Responses section for further details.
- **DATA:** This will be a variable number of bytes depending on the function code. This may include actual values, settings, or addresses sent by the master to the slave or by the slave to the master.
- **CRC:** This is a two byte error checking code. The RTU version of Modbus® includes a 16-bit cyclic redundancy check (CRC-16) with every packet which is an industry standard method used for error detection. If a Modbus slave device receives a packet in which an error is indicated by the CRC, the slave device will not act upon or respond to the packet thus preventing any erroneous operations. See the CRC-16 Algorithm section for details on calculating the CRC.
- **DEAD TIME:** A packet is terminated when no data is received for a period of 3.5 byte transmission times (about 15 ms at 2400 bps, 2 ms at 19200 bps, and 300 μs at 115200 bps). Consequently, the transmitting device must not allow gaps between bytes longer than this interval. Once the dead time has expired without a new byte transmission, all slaves start listening for a new packet from the master except for the addressed slave.

B.1.4 CRC-16 ALGORITHM

The CRC-16 algorithm essentially treats the entire data stream (data bits only; start, stop and parity ignored) as one continuous binary number. This number is first shifted left 16 bits and then divided by a characteristic polynomial (11000000000000101B). The 16 bit remainder of the division is appended to the end of the packet, MSByte first. The resulting packet including CRC, when divided by the same polynomial at the receiver will give a zero remainder if no transmission errors have occurred. This algorithm requires the characteristic polynomial to be reverse bit ordered. The most significant bit of the characteristic polynomial is dropped, since it does not affect the value of the remainder.

A C programming language implementation of the CRC algorithm will be provided upon request.

Table B–2: CRC-16 ALGORITHM

SYMBOLS:	-->	data transfer	
	A	16 bit working register	
	A _{low}	low order byte of A	
	A _{high}	high order byte of A	
	CRC	16 bit CRC-16 result	
	i,j	loop counters	
	(+)	logical EXCLUSIVE-OR operator	
	N	total number of data bytes	
	D _i	i-th data byte (i = 0 to N-1)	
	G	16 bit characteristic polynomial = 101000000000001 (binary) with MSbit dropped and bit order reversed	
	shr (x)	right shift operator (th LSbit of x is shifted into a carry flag, a '0' is shifted into the MSbit of x, all other bits are shifted right one location)	
	ALGORITHM:	1.	FFFF (hex) --> A
2.		0 --> i	
3.		0 --> j	
4.		D _i (+) A _{low} --> A _{low}	
5.		j + 1 --> j	
6.		shr (A)	
7.		Is there a carry?	No: go to 8; Yes: G (+) A --> A and continue.
8.		Is j = 8?	No: go to 5; Yes: continue
9.		i + 1 --> i	
10.		Is i = N?	No: go to 3; Yes: continue
11.		A --> CRC	

B.2.1 SUPPORTED FUNCTION CODES

Modbus[®] officially defines function codes from 1 to 127 though only a small subset is generally needed. The relay supports some of these functions, as summarized in the following table. Subsequent sections describe each function code in detail.

FUNCTION CODE		MODBUS DEFINITION	GE MULTILIN DEFINITION
HEX	DEC		
03	3	Read Holding Registers	Read Actual Values or Settings
04	4	Read Holding Registers	Read Actual Values or Settings
05	5	Force Single Coil	Execute Operation
06	6	Preset Single Register	Store Single Setting
10	16	Preset Multiple Registers	Store Multiple Settings

B.2.2 READ ACTUAL VALUES OR SETTINGS (FUNCTION CODE 03/04H)

This function code allows the master to read one or more consecutive data registers (actual values or settings) from a relay. Data registers are always 16 bit (two byte) values transmitted with high order byte first. The maximum number of registers that can be read in a single packet is 125. See the Modbus Memory Map table for exact details on the data registers.

Since some PLC implementations of Modbus[®] only support one of function codes 03h and 04h, the relay interpretation allows either function code to be used for reading one or more consecutive data registers. The data starting address will determine the type of data being read. Function codes 03h and 04h are therefore identical.

The following table shows the format of the master and slave packets. The example shows a master device requesting 3 register values starting at address 4050h from slave device 11h (17 decimal); the slave device responds with the values 40, 300, and 0 from registers 4050h, 4051h, and 4052h, respectively.

Table B-3: MASTER AND SLAVE DEVICE PACKET TRANSMISSION EXAMPLE

MASTER TRANSMISSION		SLAVE RESPONSE	
PACKET FORMAT	EXAMPLE (HEX)	PACKET FORMAT	EXAMPLE (HEX)
SLAVE ADDRESS	11	SLAVE ADDRESS	11
FUNCTION CODE	04	FUNCTION CODE	04
DATA STARTING ADDRESS - high	40	BYTE COUNT	06
DATA STARTING ADDRESS - low	50	DATA #1 - high	00
NUMBER OF REGISTERS - high	00	DATA #1 - low	28
NUMBER OF REGISTERS - low	03	DATA #2 - high	01
CRC - low	A7	DATA #2 - low	2C
CRC - high	4A	DATA #3 - high	00
		DATA #3 - low	00
		CRC - low	0D
		CRC - high	60

B.2.3 EXECUTE OPERATION (FUNCTION CODE 05H)

This function code allows the master to perform various operations in the relay. Available operations are shown in the *Summary of Operation Codes* table below.

The following table shows the format of the master and slave packets. The example shows a master device requesting the slave device 11H (17 dec) to perform a reset. The high and low Code Value bytes always have the values “FF” and “00” respectively and are a remnant of the original Modbus[®] definition of this function code.

Table B-4: MASTER AND SLAVE DEVICE PACKET TRANSMISSION EXAMPLE

MASTER TRANSMISSION		SLAVE RESPONSE	
PACKET FORMAT	EXAMPLE (HEX)	PACKET FORMAT	EXAMPLE (HEX)
SLAVE ADDRESS	11	SLAVE ADDRESS	11
FUNCTION CODE	05	FUNCTION CODE	05
OPERATION CODE - high	00	OPERATION CODE - high	00
OPERATION CODE - low	01	OPERATION CODE - low	01
CODE VALUE - high	FF	CODE VALUE - high	FF
CODE VALUE - low	00	CODE VALUE - low	00
CRC - low	DF	CRC - low	DF
CRC - high	6A	CRC - high	6A

Table B-5: SUMMARY OF OPERATION CODES FOR FUNCTION 05H

OPERATION CODE (HEX)	DEFINITION	DESCRIPTION
0000	NO OPERATION	Does not do anything.
0001	RESET	Performs the same function as the faceplate RESET key.
0005	CLEAR EVENT RECORDS	Performs the same function as the faceplate CLEAR EVENT RECORDS menu command.
0006	CLEAR OSCILLOGRAPHY	Clears all oscillography records.
1000 to 103F	VIRTUAL IN 1 to 64 ON/OFF	Sets the states of Virtual Inputs 1 to 64 either “ON” or “OFF”.

B.2.4 STORE SINGLE SETTING (FUNCTION CODE 06H)

This function code allows the master to modify the contents of a single setting register in an relay. Setting registers are always 16 bit (two byte) values transmitted high order byte first. The following table shows the format of the master and slave packets. The example shows a master device storing the value 200 at memory map address 4051h to slave device 11h (17 dec).

Table B-6: MASTER AND SLAVE DEVICE PACKET TRANSMISSION EXAMPLE

MASTER TRANSMISSION		SLAVE RESPONSE	
PACKET FORMAT	EXAMPLE (HEX)	PACKET FORMAT	EXAMPLE (HEX)
SLAVE ADDRESS	11	SLAVE ADDRESS	11
FUNCTION CODE	06	FUNCTION CODE	06
DATA STARTING ADDRESS - high	40	DATA STARTING ADDRESS - high	40
DATA STARTING ADDRESS - low	51	DATA STARTING ADDRESS - low	51
DATA - high	00	DATA - high	00
DATA - low	C8	DATA - low	C8
CRC - low	CE	CRC - low	CE
CRC - high	DD	CRC - high	DD

B.2.5 STORE MULTIPLE SETTINGS (FUNCTION CODE 10H)

This function code allows the master to modify the contents of a one or more consecutive setting registers in a relay. Setting registers are 16-bit (two byte) values transmitted high order byte first. The maximum number of setting registers that can be stored in a single packet is 60. The following table shows the format of the master and slave packets. The example shows a master device storing the value 200 at memory map address 4051h, and the value 1 at memory map address 4052h to slave device 11h (17 decimal).

Table B-7: MASTER AND SLAVE DEVICE PACKET TRANSMISSION EXAMPLE

MASTER TRANSMISSION		SLAVE RESPONSE	
PACKET FORMAT	EXAMPLE (HEX)	PACKET FORMAT	EXAMPLE (HEX)
SLAVE ADDRESS	11	SLAVE ADDRESS	11
FUNCTION CODE	10	FUNCTION CODE	10
DATA STARTING ADDRESS - hi	40	DATA STARTING ADDRESS - hi	40
DATA STARTING ADDRESS - lo	51	DATA STARTING ADDRESS - lo	51
NUMBER OF SETTINGS - hi	00	NUMBER OF SETTINGS - hi	00
NUMBER OF SETTINGS - lo	02	NUMBER OF SETTINGS - lo	02
BYTE COUNT	04	CRC - lo	07
DATA #1 - high order byte	00	CRC - hi	64
DATA #1 - low order byte	C8		
DATA #2 - high order byte	00		
DATA #2 - low order byte	01		
CRC - low order byte	12		
CRC - high order byte	62		

B.2.6 EXCEPTION RESPONSES

Programming or operation errors usually happen because of illegal data in a packet. These errors result in an exception response from the slave. The slave detecting one of these errors sends a response packet to the master with the high order bit of the function code set to 1.

The following table shows the format of the master and slave packets. The example shows a master device sending the unsupported function code 39h to slave device 11.

Table B-8: MASTER AND SLAVE DEVICE PACKET TRANSMISSION EXAMPLE

MASTER TRANSMISSION		SLAVE RESPONSE	
PACKET FORMAT	EXAMPLE (HEX)	PACKET FORMAT	EXAMPLE (HEX)
SLAVE ADDRESS	11	SLAVE ADDRESS	11
FUNCTION CODE	39	FUNCTION CODE	B9
CRC - low order byte	CD	ERROR CODE	01
CRC - high order byte	F2	CRC - low order byte	93
		CRC - high order byte	95

B.3.1 OBTAINING UR FILES VIA MODBUS

a) DESCRIPTION

The UR relay has a generic file transfer facility, meaning that you use the same method to obtain all of the different types of files from the unit. The Modbus registers that implement file transfer are found in the "Modbus File Transfer (Read/Write)" and "Modbus File Transfer (Read Only)" modules, starting at address 3100 in the Modbus Memory Map. To read a file from the UR relay, use the following steps:

1. Write the filename to the "Name of file to read" register using a write multiple registers command. If the name is shorter than 80 characters, you may write only enough registers to include all the text of the filename. Filenames are not case sensitive.
2. Repeatedly read all the registers in "Modbus File Transfer (Read Only)" using a read multiple registers command. It is not necessary to read the entire data block, since the UR relay will remember which was the last register you read. The "position" register is initially zero and thereafter indicates how many bytes (2 times the number of registers) you have read so far. The "size of..." register indicates the number of bytes of data remaining to read, to a maximum of 244.
3. Keep reading until the "size of..." register is smaller than the number of bytes you are transferring. This condition indicates end of file. Discard any bytes you have read beyond the indicated block size.
4. If you need to re-try a block, read only the "size of.." and "block of data", without reading the position. The file pointer is only incremented when you read the position register, so the same data block will be returned as was read in the previous operation. On the next read, check to see if the position is where you expect it to be, and discard the previous block if it is not (this condition would indicate that the UR relay did not process your original read request).

The UR relay retains connection-specific file transfer information, so files may be read simultaneously on multiple Modbus connections.

b) OTHER PROTOCOLS

All the files available via Modbus may also be retrieved using the standard file transfer mechanisms in other protocols (for example, TFTP or MMS).

c) COMTRADE, OSCILLOGRAPHY, AND DATA LOGGER FILES

Oscillography and data logger files are formatted using the COMTRADE file format per IEEE PC37.111 Draft 7c (02 September 1997). The files may be obtained in either text or binary COMTRADE format.

d) READING OSCILLOGRAPHY FILES

Familiarity with the oscillography feature is required to understand the following description. Refer to the Oscillography section in Chapter 5 for additional details.

The Oscillography Number of Triggers register is incremented by one every time a new oscillography file is triggered (captured) and cleared to zero when oscillography data is cleared. When a new trigger occurs, the associated oscillography file is assigned a file identifier number equal to the incremented value of this register; the newest file number is equal to the Oscillography_Number_of_Triggers register. This register can be used to determine if any new data has been captured by periodically reading it to see if the value has changed; if the number has increased then new data is available.

The Oscillography Number of Records register specifies the maximum number of files (and the number of cycles of data per file) that can be stored in memory of the relay. The Oscillography Available Records register specifies the actual number of files that are stored and still available to be read out of the relay.

Writing "Yes" (i.e. the value 1) to the Oscillography Clear Data register clears oscillography data files, clears both the Oscillography Number of Triggers and Oscillography Available Records registers to zero, and sets the Oscillography Last Cleared Date to the present date and time.

To read binary COMTRADE oscillography files, read the following filenames:

OSCnnnn . CFG and OSCnnn . DAT

Replace "nnn" with the desired oscillography trigger number. For ASCII format, use the following file names

OSCAnnnn . CFG and OSCAnnn . DAT

e) READING DATA LOGGER FILES

Familiarity with the data logger feature is required to understand this description. Refer to the Data Logger section of Chapter 5 for details. To read the entire data logger in binary COMTRADE format, read the following files.

`datalog.cfg` and `datalog.dat`

To read the entire data logger in ASCII COMTRADE format, read the following files.

`dataloga.cfg` and `dataloga.dat`

To limit the range of records to be returned in the COMTRADE files, append the following to the filename before writing it:

- To read from a specific time to the end of the log: `<space> startTime`
- To read a specific range of records: `<space> startTime <space> endTime`
- Replace `<startTime>` and `<endTime>` with Julian dates (seconds since Jan. 1 1970) as numeric text.

f) READING EVENT RECORDER FILES

To read the entire event recorder contents in ASCII format (the only available format), use the following filename:

`EVT.TXT`

To read from a specific record to the end of the log, use the following filename:

`EVTnnn.TXT` (replace `nnn` with the desired starting record number)

To read from a specific record to another specific record, use the following filename:

`EVT.TXT xxxxx yyyy` (replace `xxxxx` with the starting record number and `yyyy` with the ending record number)

B.3.2 MODBUS PASSWORD OPERATION

The COMMAND password is set up at memory location 4000. Storing a value of “0” removes COMMAND password protection. When reading the password setting, the encrypted value (zero if no password is set) is returned. COMMAND security is required to change the COMMAND password. Similarly, the SETTING password is set up at memory location 4002. These are the same settings and encrypted values found in the **SETTINGS** ⇒ **PRODUCT SETUP** ⇒ **PASSWORD SECURITY** menu via the keypad. Enabling password security for the faceplate display will also enable it for Modbus, and vice-versa.

To gain COMMAND level security access, the COMMAND password must be entered at memory location 4008. To gain SETTING level security access, the SETTING password must be entered at memory location 400A. The entered SETTING password must match the current SETTING password setting, or must be zero, to change settings or download firmware.

COMMAND and SETTING passwords each have a 30-minute timer. Each timer starts when you enter the particular password, and is re-started whenever you “use” it. For example, writing a setting re-starts the SETTING password timer and writing a command register or forcing a coil re-starts the COMMAND password timer. The value read at memory location 4010 can be used to confirm whether a COMMAND password is enabled or disabled (0 for Disabled). The value read at memory location 4011 can be used to confirm whether a SETTING password is enabled or disabled.

COMMAND or SETTING password security access is restricted to the particular port or particular TCP/IP connection on which the entry was made. Passwords must be entered when accessing the relay through other ports or connections, and the passwords must be re-entered after disconnecting and re-connecting on TCP/IP.

B.4.1 MODBUS MEMORY MAP

Table B-9: MODBUS MEMORY MAP (Sheet 1 of 43)

ADDR	REGISTER NAME	RANGE	UNITS	STEP	FORMAT	DEFAULT
Product Information (Read Only)						
0000	UR Product Type	0 to 65535	---	1	F001	0
0002	Product Version	0 to 655.35	---	0.01	F001	1
Product Information (Read Only -- Written by Factory)						
0010	Serial Number	---	---	---	F203	"0"
0020	Manufacturing Date	0 to 4294967295	---	1	F050	0
0022	Modification Number	0 to 65535	---	1	F001	0
0040	Order Code	---	---	---	F204	"Order Code x"
0090	Ethernet MAC Address	---	---	---	F072	0
0093	Reserved (13 items)	---	---	---	F001	0
00A0	CPU Module Serial Number	---	---	---	F203	(none)
00B0	CPU Supplier Serial Number	---	---	---	F203	(none)
00C0	Ethernet Sub Module Serial Number (8 items)	---	---	---	F203	(none)
Self Test Targets (Read Only)						
0200	Self Test States (2 items)	0 to 4294967295	0	1	F143	0
Front Panel (Read Only)						
0204	LED Column <i>n</i> State, <i>n</i> = 1 to 10 (10 items)	0 to 65535	---	1	F501	0
0220	Display Message	---	---	---	F204	(none)
0248	Last Key Pressed	0 to 47	---	1	F530	0 (None)
Keypress Emulation (Read/Write)						
0280	Simulated keypress -- write zero before each keystroke	0 to 42	---	1	F190	0 (No key -- use between real keys)
Virtual Input Commands (Read/Write Command) (64 modules)						
0400	Virtual Input 1 State	0 to 1	---	1	F108	0 (Off)
0401	Virtual Input 2 State	0 to 1	---	1	F108	0 (Off)
0402	Virtual Input 3 State	0 to 1	---	1	F108	0 (Off)
0403	Virtual Input 4 State	0 to 1	---	1	F108	0 (Off)
0404	Virtual Input 5 State	0 to 1	---	1	F108	0 (Off)
0405	Virtual Input 6 State	0 to 1	---	1	F108	0 (Off)
0406	Virtual Input 7 State	0 to 1	---	1	F108	0 (Off)
0407	Virtual Input 8 State	0 to 1	---	1	F108	0 (Off)
0408	Virtual Input 9 State	0 to 1	---	1	F108	0 (Off)
0409	Virtual Input 10 State	0 to 1	---	1	F108	0 (Off)
040A	Virtual Input 11 State	0 to 1	---	1	F108	0 (Off)
040B	Virtual Input 12 State	0 to 1	---	1	F108	0 (Off)
040C	Virtual Input 13 State	0 to 1	---	1	F108	0 (Off)
040D	Virtual Input 14 State	0 to 1	---	1	F108	0 (Off)
040E	Virtual Input 15 State	0 to 1	---	1	F108	0 (Off)
040F	Virtual Input 16 State	0 to 1	---	1	F108	0 (Off)
0410	Virtual Input 17 State	0 to 1	---	1	F108	0 (Off)
0411	Virtual Input 18 State	0 to 1	---	1	F108	0 (Off)
0412	Virtual Input 19 State	0 to 1	---	1	F108	0 (Off)
0413	Virtual Input 20 State	0 to 1	---	1	F108	0 (Off)
0414	Virtual Input 21 State	0 to 1	---	1	F108	0 (Off)
0415	Virtual Input 22 State	0 to 1	---	1	F108	0 (Off)
0416	Virtual Input 23 State	0 to 1	---	1	F108	0 (Off)
0417	Virtual Input 24 State	0 to 1	---	1	F108	0 (Off)
0418	Virtual Input 25 State	0 to 1	---	1	F108	0 (Off)
0419	Virtual Input 26 State	0 to 1	---	1	F108	0 (Off)
041A	Virtual Input 27 State	0 to 1	---	1	F108	0 (Off)
041B	Virtual Input 28 State	0 to 1	---	1	F108	0 (Off)

B

Table B-9: MODBUS MEMORY MAP (Sheet 2 of 43)

ADDR	REGISTER NAME	RANGE	UNITS	STEP	FORMAT	DEFAULT
041C	Virtual Input 29 State	0 to 1	---	1	F108	0 (Off)
041D	Virtual Input 30 State	0 to 1	---	1	F108	0 (Off)
041E	Virtual Input 31 State	0 to 1	---	1	F108	0 (Off)
041F	Virtual Input 32 State	0 to 1	---	1	F108	0 (Off)
0420	Virtual Input 33 State	0 to 1	---	1	F108	0 (Off)
0421	Virtual Input 34 State	0 to 1	---	1	F108	0 (Off)
0422	Virtual Input 35 State	0 to 1	---	1	F108	0 (Off)
0423	Virtual Input 36 State	0 to 1	---	1	F108	0 (Off)
0424	Virtual Input 37 State	0 to 1	---	1	F108	0 (Off)
0425	Virtual Input 38 State	0 to 1	---	1	F108	0 (Off)
0426	Virtual Input 39 State	0 to 1	---	1	F108	0 (Off)
0427	Virtual Input 40 State	0 to 1	---	1	F108	0 (Off)
0428	Virtual Input 41 State	0 to 1	---	1	F108	0 (Off)
0429	Virtual Input 42 State	0 to 1	---	1	F108	0 (Off)
042A	Virtual Input 43 State	0 to 1	---	1	F108	0 (Off)
042B	Virtual Input 44 State	0 to 1	---	1	F108	0 (Off)
042C	Virtual Input 45 State	0 to 1	---	1	F108	0 (Off)
042D	Virtual Input 46 State	0 to 1	---	1	F108	0 (Off)
042E	Virtual Input 47 State	0 to 1	---	1	F108	0 (Off)
042F	Virtual Input 48 State	0 to 1	---	1	F108	0 (Off)
0430	Virtual Input 49 State	0 to 1	---	1	F108	0 (Off)
0431	Virtual Input 50 State	0 to 1	---	1	F108	0 (Off)
0432	Virtual Input 51 State	0 to 1	---	1	F108	0 (Off)
0433	Virtual Input 52 State	0 to 1	---	1	F108	0 (Off)
0434	Virtual Input 53 State	0 to 1	---	1	F108	0 (Off)
0435	Virtual Input 54 State	0 to 1	---	1	F108	0 (Off)
0436	Virtual Input 55 State	0 to 1	---	1	F108	0 (Off)
0437	Virtual Input 56 State	0 to 1	---	1	F108	0 (Off)
0438	Virtual Input 57 State	0 to 1	---	1	F108	0 (Off)
0439	Virtual Input 58 State	0 to 1	---	1	F108	0 (Off)
043A	Virtual Input 59 State	0 to 1	---	1	F108	0 (Off)
043B	Virtual Input 60 State	0 to 1	---	1	F108	0 (Off)
043C	Virtual Input 61 State	0 to 1	---	1	F108	0 (Off)
043D	Virtual Input 62 State	0 to 1	---	1	F108	0 (Off)
043E	Virtual Input 63 State	0 to 1	---	1	F108	0 (Off)
043F	Virtual Input 64 State	0 to 1	---	1	F108	0 (Off)
Digital Counter States (Read Only Non-Volatile) (8 modules)						
0800	Digital Counter 1 Value	-2147483647 to 2147483647	---	1	F004	0
0802	Digital Counter 1 Frozen	-2147483647 to 2147483647	---	1	F004	0
0804	Digital Counter 1 Frozen Time Stamp	0 to 4294967295	---	1	F050	0
0806	Digital Counter 1 Frozen Time Stamp us	0 to 4294967295	---	1	F003	0
0808	...Repeated for Digital Counter 2					
0810	...Repeated for Digital Counter 3					
0818	...Repeated for Digital Counter 4					
0820	...Repeated for Digital Counter 5					
0828	...Repeated for Digital Counter 6					
0830	...Repeated for Digital Counter 7					
0838	...Repeated for Digital Counter 8					
FlexStates (Read Only)						
0900	FlexState Bits (16 items)	0 to 65535	---	1	F001	0
Element States (Read Only)						
1000	Element Operate States (64 items)	0 to 65535	---	1	F502	0

B

Table B-9: MODBUS MEMORY MAP (Sheet 3 of 43)

ADDR	REGISTER NAME	RANGE	UNITS	STEP	FORMAT	DEFAULT
User Displays Actuals (Read Only)						
1080	Formatted user-definable displays (16 items)	---	---	---	F200	(none)
Modbus User Map Actuals (Read Only)						
1200	User Map Values (256 items)	0 to 65535	---	1	F001	0
Element Targets (Read Only)						
14C0	Target Sequence	0 to 65535	---	1	F001	0
14C1	Number of Targets	0 to 65535	---	1	F001	0
Element Targets (Read/Write)						
14C2	Target to Read	0 to 65535	---	1	F001	0
Element Targets (Read Only)						
14C3	Target Message	---	---	---	F200	“.”
Digital Input/Output States (Read Only)						
1500	Contact Input States (6 items)	0 to 65535	---	1	F500	0
1508	Virtual Input States (8 items)	0 to 65535	---	1	F500	0
1510	Contact Output States (4 items)	0 to 65535	---	1	F500	0
1518	Contact Output Current States (4 items)	0 to 65535	---	1	F500	0
1520	Contact Output Voltage States (4 items)	0 to 65535	---	1	F500	0
1528	Virtual Output States (6 items)	0 to 65535	---	1	F500	0
1530	Contact Output Detectors (4 items)	0 to 65535	---	1	F500	0
Remote Input/Output States (Read Only)						
1540	Remote Device 1 States	0 to 65535	---	1	F500	0
1542	Remote Input States (4 items)	0 to 65535	---	1	F500	0
1550	Remote Devices Online	0 to 1	---	1	F126	0 (No)
Remote Device Status (Read Only) (16 modules)						
1551	Remote Device 1 StNum	0 to 4294967295	---	1	F003	0
1553	Remote Device 1 SqNum	0 to 4294967295	---	1	F003	0
1555	...Repeated for Remote Device 2					
1559	...Repeated for Remote Device 3					
155D	...Repeated for Remote Device 4					
1561	...Repeated for Remote Device 5					
1565	...Repeated for Remote Device 6					
1569	...Repeated for Remote Device 7					
156D	...Repeated for Remote Device 8					
1571	...Repeated for Remote Device 9					
1575	...Repeated for Remote Device 10					
1579	...Repeated for Remote Device 11					
157D	...Repeated for Remote Device 12					
1581	...Repeated for Remote Device 13					
1585	...Repeated for Remote Device 14					
1589	...Repeated for Remote Device 15					
158D	...Repeated for Remote Device 16					
Platform Direct Input/Output States (Read Only)						
15C0	Direct input states (6 items)	0 to 65535	---	1	F500	0
15C8	Direct outputs average message return time 1	0 to 65535	ms	1	F001	0
15C9	Direct outputs average message return time 2	0 to 65535	ms	1	F001	0
15CA	Direct inputs/outputs unreturned message count - Ch. 1	0 to 65535	---	1	F001	0
15CB	Direct inputs/outputs unreturned message count - Ch. 2	0 to 65535	---	1	F001	0
15D0	Direct device states	0 to 65535	---	1	F500	0
15D1	Reserved	0 to 65535	---	1	F001	0
15D2	Direct inputs/outputs CRC fail count 1	0 to 65535	---	1	F001	0
15D3	Direct inputs/outputs CRC fail count 2	0 to 65535	---	1	F001	0
Ethernet Fibre Channel Status (Read/Write)						
1610	Ethernet primary fibre channel status	0 to 2	---	1	F134	0 (Fail)
1611	Ethernet secondary fibre channel status	0 to 2	---	1	F134	0 (Fail)

B

Table B-9: MODBUS MEMORY MAP (Sheet 4 of 43)

ADDR	REGISTER NAME	RANGE	UNITS	STEP	FORMAT	DEFAULT
Data Logger Actuals (Read Only)						
1618	Data logger channel count	0 to 16	channel	1	F001	0
1619	Time of oldest available samples	0 to 4294967295	seconds	1	F050	0
161B	Time of newest available samples	0 to 4294967295	seconds	1	F050	0
161D	Data logger duration	0 to 999.9	days	0.1	F001	0
Restricted Ground Fault Currents (Read Only) (6 modules)						
16A0	Differential Ground Current Magnitude	0 to 999999.999	A	0.001	F060	0
16A2	Restricted Ground Current Magnitude	0 to 999999.999	A	0.001	F060	0
16A4	...Repeated for Restricted Ground Fault 2					
16A8	...Repeated for Restricted Ground Fault 3					
16AC	...Repeated for Restricted Ground Fault 4					
16B0	...Repeated for Restricted Ground Fault 5					
16B4	...Repeated for Restricted Ground Fault 6					
Source Current (Read Only) (6 modules)						
1800	Source 1 Phase A Current RMS	0 to 999999.999	A	0.001	F060	0
1802	Source 1 Phase B Current RMS	0 to 999999.999	A	0.001	F060	0
1804	Source 1 Phase C Current RMS	0 to 999999.999	A	0.001	F060	0
1806	Source 1 Neutral Current RMS	0 to 999999.999	A	0.001	F060	0
1808	Source 1 Phase A Current Magnitude	0 to 999999.999	A	0.001	F060	0
180A	Source 1 Phase A Current Angle	-359.9 to 0	degrees	0.1	F002	0
180B	Source 1 Phase B Current Magnitude	0 to 999999.999	A	0.001	F060	0
180D	Source 1 Phase B Current Angle	-359.9 to 0	degrees	0.1	F002	0
180E	Source 1 Phase C Current Magnitude	0 to 999999.999	A	0.001	F060	0
1810	Source 1 Phase C Current Angle	-359.9 to 0	degrees	0.1	F002	0
1811	Source 1 Neutral Current Magnitude	0 to 999999.999	A	0.001	F060	0
1813	Source 1 Neutral Current Angle	-359.9 to 0	degrees	0.1	F002	0
1814	Source 1 Ground Current RMS	0 to 999999.999	A	0.001	F060	0
1816	Source 1 Ground Current Magnitude	0 to 999999.999	A	0.001	F060	0
1818	Source 1 Ground Current Angle	-359.9 to 0	degrees	0.1	F002	0
1819	Source 1 Zero Sequence Current Magnitude	0 to 999999.999	A	0.001	F060	0
181B	Source 1 Zero Sequence Current Angle	-359.9 to 0	degrees	0.1	F002	0
181C	Source 1 Positive Sequence Current Magnitude	0 to 999999.999	A	0.001	F060	0
181E	Source 1 Positive Sequence Current Angle	-359.9 to 0	degrees	0.1	F002	0
181F	Source 1 Negative Sequence Current Magnitude	0 to 999999.999	A	0.001	F060	0
1821	Source 1 Negative Sequence Current Angle	-359.9 to 0	degrees	0.1	F002	0
1822	Source 1 Differential Ground Current Magnitude	0 to 999999.999	A	0.001	F060	0
1824	Source 1 Differential Ground Current Angle	-359.9 to 0	degrees	0.1	F002	0
1825	Reserved (27 items)	---	---	---	F001	0
1840	...Repeated for Source 2					
1880	...Repeated for Source 3					
18C0	...Repeated for Source 4					
1900	...Repeated for Source 5					
1940	...Repeated for Source 6					
Source Voltage (Read Only) (6 modules)						
1A00	Source 1 Phase AG Voltage RMS	0 to 999999.999	V	0.001	F060	0
1A02	Source 1 Phase BG Voltage RMS	0 to 999999.999	V	0.001	F060	0
1A04	Source 1 Phase CG Voltage RMS	0 to 999999.999	V	0.001	F060	0
1A06	Source 1 Phase AG Voltage Magnitude	0 to 999999.999	V	0.001	F060	0
1A08	Source 1 Phase AG Voltage Angle	-359.9 to 0	degrees	0.1	F002	0
1A09	Source 1 Phase BG Voltage Magnitude	0 to 999999.999	V	0.001	F060	0
1A0B	Source 1 Phase BG Voltage Angle	-359.9 to 0	degrees	0.1	F002	0
1A0C	Source 1 Phase CG Voltage Magnitude	0 to 999999.999	V	0.001	F060	0
1A0E	Source 1 Phase CG Voltage Angle	-359.9 to 0	degrees	0.1	F002	0
1A0F	Source 1 Phase AB or AC Voltage RMS	0 to 999999.999	V	0.001	F060	0

B

Table B-9: MODBUS MEMORY MAP (Sheet 5 of 43)

ADDR	REGISTER NAME	RANGE	UNITS	STEP	FORMAT	DEFAULT
1A11	Source 1 Phase BC or BA Voltage RMS	0 to 999999.999	V	0.001	F060	0
1A13	Source 1 Phase CA or CB Voltage RMS	0 to 999999.999	V	0.001	F060	0
1A15	Source 1 Phase AB or AC Voltage Magnitude	0 to 999999.999	V	0.001	F060	0
1A17	Source 1 Phase AB or AC Voltage Angle	-359.9 to 0	degrees	0.1	F002	0
1A18	Source 1 Phase BC or BA Voltage Magnitude	0 to 999999.999	V	0.001	F060	0
1A1A	Source 1 Phase BC or BA Voltage Angle	-359.9 to 0	degrees	0.1	F002	0
1A1B	Source 1 Phase CA or CB Voltage Magnitude	0 to 999999.999	V	0.001	F060	0
1A1D	Source 1 Phase CA or CB Voltage Angle	-359.9 to 0	degrees	0.1	F002	0
1A1E	Source 1 Auxiliary Voltage RMS	0 to 999999.999	V	0.001	F060	0
1A20	Source 1 Auxiliary Voltage Magnitude	0 to 999999.999	V	0.001	F060	0
1A22	Source 1 Auxiliary Voltage Angle	-359.9 to 0	degrees	0.1	F002	0
1A23	Source 1 Zero Sequence Voltage Magnitude	0 to 999999.999	V	0.001	F060	0
1A25	Source 1 Zero Sequence Voltage Angle	-359.9 to 0	degrees	0.1	F002	0
1A26	Source 1 Positive Sequence Voltage Magnitude	0 to 999999.999	V	0.001	F060	0
1A28	Source 1 Positive Sequence Voltage Angle	-359.9 to 0	degrees	0.1	F002	0
1A29	Source 1 Negative Sequence Voltage Magnitude	0 to 999999.999	V	0.001	F060	0
1A2B	Source 1 Negative Sequence Voltage Angle	-359.9 to 0	degrees	0.1	F002	0
1A2C	Reserved (20 items)	---	---	---	F001	0
1A40	...Repeated for Source 2					
1A80	...Repeated for Source 3					
1AC0	...Repeated for Source 4					
1B00	...Repeated for Source 5					
1B40	...Repeated for Source 6					
Source Power (Read Only) (6 modules)						
1C00	Source 1 Three Phase Real Power	-1000000000000 to 1000000000000	W	0.001	F060	0
1C02	Source 1 Phase A Real Power	-1000000000000 to 1000000000000	W	0.001	F060	0
1C04	Source 1 Phase B Real Power	-1000000000000 to 1000000000000	W	0.001	F060	0
1C06	Source 1 Phase C Real Power	-1000000000000 to 1000000000000	W	0.001	F060	0
1C08	Source 1 Three Phase Reactive Power	-1000000000000 to 1000000000000	var	0.001	F060	0
1C0A	Source 1 Phase A Reactive Power	-1000000000000 to 1000000000000	var	0.001	F060	0
1C0C	Source 1 Phase B Reactive Power	-1000000000000 to 1000000000000	var	0.001	F060	0
1C0E	Source 1 Phase C Reactive Power	-1000000000000 to 1000000000000	var	0.001	F060	0
1C10	Source 1 Three Phase Apparent Power	-1000000000000 to 1000000000000	VA	0.001	F060	0
1C12	Source 1 Phase A Apparent Power	-1000000000000 to 1000000000000	VA	0.001	F060	0
1C14	Source 1 Phase B Apparent Power	-1000000000000 to 1000000000000	VA	0.001	F060	0
1C16	Source 1 Phase C Apparent Power	-1000000000000 to 1000000000000	VA	0.001	F060	0
1C18	Source 1 Three Phase Power Factor	-0.999 to 1	---	0.001	F013	0
1C19	Source 1 Phase A Power Factor	-0.999 to 1	---	0.001	F013	0
1C1A	Source 1 Phase B Power Factor	-0.999 to 1	---	0.001	F013	0
1C1B	Source 1 Phase C Power Factor	-0.999 to 1	---	0.001	F013	0
1C1C	Reserved (4 items)	---	---	---	F001	0
1C20	...Repeated for Source 2					
1C40	...Repeated for Source 3					
1C60	...Repeated for Source 4					
1C80	...Repeated for Source 5					
1CA0	...Repeated for Source 6					

B

Table B-9: MODBUS MEMORY MAP (Sheet 6 of 43)

ADDR	REGISTER NAME	RANGE	UNITS	STEP	FORMAT	DEFAULT
Source Energy (Read Only Non-Volatile) (6 modules)						
1D00	Source 1 Positive Watthour	0 to 1000000000000	Wh	0.001	F060	0
1D02	Source 1 Negative Watthour	0 to 1000000000000	Wh	0.001	F060	0
1D04	Source 1 Positive Varhour	0 to 1000000000000	varh	0.001	F060	0
1D06	Source 1 Negative Varhour	0 to 1000000000000	varh	0.001	F060	0
1D08	Reserved (8 items)	---	---	---	F001	0
1D10	...Repeated for Source 2					
1D20	...Repeated for Source 3					
1D30	...Repeated for Source 4					
1D40	...Repeated for Source 5					
1D50	...Repeated for Source 6					
Energy Commands (Read/Write Command)						
1D60	Energy Clear Command	0 to 1	---	1	F126	0 (No)
Source Frequency (Read Only) (6 modules)						
1D80	Frequency for Source 1	2 to 90	Hz	0.01	F001	0
1D81	Frequency for Source 2	2 to 90	Hz	0.01	F001	0
1D82	Frequency for Source 3	2 to 90	Hz	0.01	F001	0
1D83	Frequency for Source 4	2 to 90	Hz	0.01	F001	0
1D84	Frequency for Source 5	2 to 90	Hz	0.01	F001	0
1D85	Frequency for Source 6	2 to 90	Hz	0.01	F001	0
Source Demand (Read Only) (6 modules)						
1E00	Source 1 Demand Ia	0 to 999999.999	A	0.001	F060	0
1E02	Source 1 Demand Ib	0 to 999999.999	A	0.001	F060	0
1E04	Source 1 Demand Ic	0 to 999999.999	A	0.001	F060	0
1E06	Source 1 Demand Watt	0 to 999999.999	W	0.001	F060	0
1E08	Source 1 Demand Var	0 to 999999.999	var	0.001	F060	0
1E0A	Source 1 Demand Va	0 to 999999.999	VA	0.001	F060	0
1E0C	Reserved (4 items)	---	---	---	F001	0
1E10	...Repeated for Source 2					
1E20	...Repeated for Source 3					
1E30	...Repeated for Source 4					
1E40	...Repeated for Source 5					
1E50	...Repeated for Source 6					
Source Demand Peaks (Read Only Non-Volatile) (6 modules)						
1E80	Source 1 Demand Ia Maximum	0 to 999999.999	A	0.001	F060	0
1E82	Source 1 Demand Ia Maximum Date	0 to 4294967295	---	1	F050	0
1E84	Source 1 Demand Ib Maximum	0 to 999999.999	A	0.001	F060	0
1E86	Source 1 Demand Ib Maximum Date	0 to 4294967295	---	1	F050	0
1E88	Source 1 Demand Ic Maximum	0 to 999999.999	A	0.001	F060	0
1E8A	Source 1 Demand Ic Maximum Date	0 to 4294967295	---	1	F050	0
1E8C	Source 1 Demand Watt Maximum	0 to 999999.999	W	0.001	F060	0
1E8E	Source 1 Demand Watt Maximum Date	0 to 4294967295	---	1	F050	0
1E90	Source 1 Demand Var	0 to 999999.999	var	0.001	F060	0
1E92	Source 1 Demand Var Maximum Date	0 to 4294967295	---	1	F050	0
1E94	Source 1 Demand Va Maximum	0 to 999999.999	VA	0.001	F060	0
1E96	Source 1 Demand Va Maximum Date	0 to 4294967295	---	1	F050	0
1E98	Reserved (8 items)	---	---	---	F001	0
1EA0	...Repeated for Source 2					
1EC0	...Repeated for Source 3					
1EE0	...Repeated for Source 4					
1F00	...Repeated for Source 5					
1F20	...Repeated for Source 6					
Breaker Arcing Current Actuals (Read Only Non-Volatile) (2 modules)						
21E0	Breaker 1 Arcing Current Phase A	0 to 99999999	kA ² -cyc	1	F060	0

B

Table B-9: MODBUS MEMORY MAP (Sheet 7 of 43)

ADDR	REGISTER NAME	RANGE	UNITS	STEP	FORMAT	DEFAULT
21E2	Breaker 1 Arcing Current Phase B	0 to 99999999	kA ² -cyc	1	F060	0
21E4	Breaker 1 Arcing Current Phase C	0 to 99999999	kA ² -cyc	1	F060	0
21E6	Breaker 1 Operating Time Phase A	0 to 65535	ms	1	F001	0
21E7	Breaker 1 Operating Time Phase B	0 to 65535	ms	1	F001	0
21E8	Breaker 1 Operating Time Phase C	0 to 65535	ms	1	F001	0
21E9	Breaker 1 Operating Time	0 to 65535	ms	1	F001	0
21E6	...Repeated for Breaker Arcing Current 2					
Breaker Arcing Current Commands (Read/Write Command) (2 modules)						
2224	Breaker 1 Arcing Current Clear Command	0 to 1	---	1	F126	0 (No)
2225	Breaker 2 Arcing Current Clear Command	0 to 1	---	1	F126	0 (No)
Passwords Unauthorized Access (Read/Write Command)						
2230	Reset Unauthorized Access	0 to 1	---	1	F126	0 (No)
Transformer Differential And Restraint (Read Only)						
2300	Transformer Reference Winding	1 to 6	---	1	F001	1
2301	Transformer Differential Phasor Iad Magnitude	0 to 30	pu	0.001	F001	0
2302	Transformer Differential Phasor Iad Angle	-359.9 to 0	degrees	0.1	F002	0
2303	Transformer Restraint Phasor Iar Magnitude	0 to 30	pu	0.001	F001	0
2304	Transformer Restraint Phasor Iar Angle	-359.9 to 0	degrees	0.1	F002	0
2305	Transformer Differential 2nd Harm Iad Magnitude	0 to 999.9	% fo	0.1	F001	0
2306	Transformer Differential 2nd Harm Iad Angle	-359.9 to 0	degrees	0.1	F002	0
2307	Transformer Differential 5th Harm Iad Magnitude	0 to 999.9	% fo	0.1	F001	0
2308	Transformer Differential 5th Harm Iad Angle	-359.9 to 0	degrees	0.1	F002	0
2309	Transformer Differential Phasor Ibd Magnitude	0 to 30	pu	0.001	F001	0
230A	Transformer Differential Phasor Ibd Angle	-359.9 to 0	degrees	0.1	F002	0
230B	Transformer Restraint Phasor Ibr Magnitude	0 to 30	pu	0.001	F001	0
230C	Transformer Restraint Phasor Ibr Angle	-359.9 to 0	degrees	0.1	F002	0
230D	Transformer Differential 2nd Harm Ibd Magnitude	0 to 999.9	% fo	0.1	F001	0
230E	Transformer Differential 2nd Harm Ibd Angle	-359.9 to 0	degrees	0.1	F002	0
230F	Transformer Differential 5th Harm Ibd Magnitude	0 to 999.9	% fo	0.1	F001	0
2310	Transformer Differential 5th Harm Ibd Angle	-359.9 to 0	degrees	0.1	F002	0
2311	Transformer Differential Phasor Icd Magnitude	0 to 30	pu	0.001	F001	0
2312	Transformer Differential Phasor Icd Angle	-359.9 to 0	degrees	0.1	F002	0
2313	Transformer Restraint Phasor Icr Magnitude	0 to 30	pu	0.001	F001	0
2314	Transformer Restraint Phasor Icr Angle	-359.9 to 0	degrees	0.1	F002	0
2315	Transformer Differential 2nd Harm Icd Magnitude	0 to 999.9	% fo	0.1	F001	0
2316	Transformer Differential 2nd Harm Icd Angle	-359.9 to 0	degrees	0.1	F002	0
2317	Transformer Differential 5th Harm Icd Magnitude	0 to 999.9	% fo	0.1	F001	0
2318	Transformer Differential 5th Harm Icd Angle	-359.9 to 0	degrees	0.1	F002	0
Transformer Thermal Inputs Actuals (Read Only)						
2330	Transformer Top Oil Temperature	0 to 300	°C	1	F002	0
2331	Transformer Hottest Spot Temperature	0 to 300	°C	1	F002	0
2332	Transformer Aging Factor	0 to 6553.5	PU	0.1	F001	0
2333	Transformer Daily Loss Of Life	0 to 500000	Hours	1	F060	0
Source Current THD And Harmonics (Read Only) (6 modules)						
2800	Ia THD for Source 1	0 to 99.9	---	0.1	F001	0
2801	Ia Harmonics for Source 1 - 2nd to 25th (24 items)	0 to 99.9	---	0.1	F001	0
2821	Ib THD for Source 1	0 to 99.9	---	0.1	F001	0
2822	Ib Harmonics for Source 1 - 2nd to 25th (24 items)	0 to 99.9	---	0.1	F001	0
283A	Reserved (8 items)	0 to 0.1	---	0.1	F001	0
2842	Ic THD for Source 1	0 to 99.9	---	0.1	F001	0
2843	Ic Harmonics for Source 1 - 2nd to 25th (24 items)	0 to 99.9	---	0.1	F001	0
285B	Reserved (8 items)	0 to 0.1	---	0.1	F001	0
2863	...Repeated for Source 2					
28C6	...Repeated for Source 3					

Table B-9: MODBUS MEMORY MAP (Sheet 8 of 43)

ADDR	REGISTER NAME	RANGE	UNITS	STEP	FORMAT	DEFAULT
2929	...Repeated for Source 4					
298C	...Repeated for Source 5					
29EF	...Repeated for Source 6					
Expanded FlexStates (Read Only)						
2B00	FlexStates, one per register (256 items)	0 to 1	---	1	F108	0 (Off)
Expanded Digital Input/Output states (Read Only)						
2D00	Contact Input States, one per register (96 items)	0 to 1	---	1	F108	0 (Off)
2D80	Contact Output States, one per register (64 items)	0 to 1	---	1	F108	0 (Off)
2E00	Virtual Output States, one per register (96 items)	0 to 1	---	1	F108	0 (Off)
Expanded Remote Input/Output Status (Read Only)						
2F00	Remote Device States, one per register (16 items)	0 to 1	---	1	F155	0 (Offline)
2F80	Remote Input States, one per register (64 items)	0 to 1	---	1	F108	0 (Off)
Oscillography Values (Read Only)						
3000	Oscillography Number of Triggers	0 to 65535	---	1	F001	0
3001	Oscillography Available Records	0 to 65535	---	1	F001	0
3002	Oscillography Last Cleared Date	0 to 400000000	---	1	F050	0
3004	Oscillography Number Of Cycles Per Record	0 to 65535	---	1	F001	0
Oscillography Commands (Read/Write Command)						
3005	Oscillography Force Trigger	0 to 1	---	1	F126	0 (No)
3011	Oscillography Clear Data	0 to 1	---	1	F126	0 (No)
User Programmable Fault Report Commands (Read/Write Command)						
3060	User Fault Report Clear	0 to 1	---	1	F126	0 (No)
User Programmable Fault Report Actuals (Read Only)						
3070	Newest Record Number	0 to 65535	---	1	F001	0
3071	Cleared Date	0 to 4294967295	---	1	F050	0
3073	Report Date (10 items)	0 to 4294967295	---	1	F050	0
User Programmable Fault Report (Read/Write Setting) (2 modules)						
3090	Fault Report 1 Fault Trigger	0 to 65535	---	1	F300	0
3091	Fault Report 1 Function	0 to 1	---	1	F102	0 (Disabled)
3092	Fault Report 1 Prefault Trigger	0 to 65535	---	1	F300	0
3093	Fault Report Analog Channel 1 (32 items)	0 to 65536	---	1	F600	0
30B3	Fault Report 1 Reserved (5 items)	---	---	---	F001	0
30B8	...Repeated for Fault Report 2					
Modbus File Transfer (Read/Write)						
3100	Name of file to read	---	---	---	F204	(none)
Modbus File Transfer (Read Only)						
3200	Character position of current block within file	0 to 4294967295	---	1	F003	0
3202	Size of currently-available data block	0 to 65535	---	1	F001	0
3203	Block of data from requested file (122 items)	0 to 65535	---	1	F001	0
Event Recorder (Read Only)						
3400	Events Since Last Clear	0 to 4294967295	---	1	F003	0
3402	Number of Available Events	0 to 4294967295	---	1	F003	0
3404	Event Recorder Last Cleared Date	0 to 4294967295	---	1	F050	0
Event Recorder (Read/Write Command)						
3406	Event Recorder Clear Command	0 to 1	---	1	F126	0 (No)
DCMA Input Values (Read Only) (24 modules)						
34C0	DCMA Inputs 1 Value	-9999999 to 9999999	---	1	F004	0
34C2	DCMA Inputs 2 Value	-9999999 to 9999999	---	1	F004	0
34C4	DCMA Inputs 3 Value	-9999999 to 9999999	---	1	F004	0
34C6	DCMA Inputs 4 Value	-9999999 to 9999999	---	1	F004	0
34C8	DCMA Inputs 5 Value	-9999999 to 9999999	---	1	F004	0
34CA	DCMA Inputs 6 Value	-9999999 to 9999999	---	1	F004	0
34CC	DCMA Inputs 7 Value	-9999999 to 9999999	---	1	F004	0
34CE	DCMA Inputs 8 Value	-9999999 to 9999999	---	1	F004	0

B

Table B-9: MODBUS MEMORY MAP (Sheet 9 of 43)

ADDR	REGISTER NAME	RANGE	UNITS	STEP	FORMAT	DEFAULT
34D0	DCMA Inputs 9 Value	-9999999 to 9999999	---	1	F004	0
34D2	DCMA Inputs 10 Value	-9999999 to 9999999	---	1	F004	0
34D4	DCMA Inputs 11 Value	-9999999 to 9999999	---	1	F004	0
34D6	DCMA Inputs 12 Value	-9999999 to 9999999	---	1	F004	0
34D8	DCMA Inputs 13 Value	-9999999 to 9999999	---	1	F004	0
34DA	DCMA Inputs 14 Value	-9999999 to 9999999	---	1	F004	0
34DC	DCMA Inputs 15 Value	-9999999 to 9999999	---	1	F004	0
34DE	DCMA Inputs 16 Value	-9999999 to 9999999	---	1	F004	0
34E0	DCMA Inputs 17 Value	-9999999 to 9999999	---	1	F004	0
34E2	DCMA Inputs 18 Value	-9999999 to 9999999	---	1	F004	0
34E4	DCMA Inputs 19 Value	-9999999 to 9999999	---	1	F004	0
34E6	DCMA Inputs 20 Value	-9999999 to 9999999	---	1	F004	0
34E8	DCMA Inputs 21 Value	-9999999 to 9999999	---	1	F004	0
34EA	DCMA Inputs 22 Value	-9999999 to 9999999	---	1	F004	0
34EC	DCMA Inputs 23 Value	-9999999 to 9999999	---	1	F004	0
34EE	DCMA Inputs 24 Value	-9999999 to 9999999	---	1	F004	0
RTD Input Values (Read Only) (48 modules)						
34F0	RTD Input 1 Value	-32768 to 32767	°C	1	F002	0
34F1	RTD Input 2 Value	-32768 to 32767	°C	1	F002	0
34F2	RTD Input 3 Value	-32768 to 32767	°C	1	F002	0
34F3	RTD Input 4 Value	-32768 to 32767	°C	1	F002	0
34F4	RTD Input 5 Value	-32768 to 32767	°C	1	F002	0
34F5	RTD Input 6 Value	-32768 to 32767	°C	1	F002	0
34F6	RTD Input 7 Value	-32768 to 32767	°C	1	F002	0
34F7	RTD Input 8 Value	-32768 to 32767	°C	1	F002	0
34F8	RTD Input 9 Value	-32768 to 32767	°C	1	F002	0
34F9	RTD Input 10 Value	-32768 to 32767	°C	1	F002	0
34FA	RTD Input 11 Value	-32768 to 32767	°C	1	F002	0
34FB	RTD Input 12 Value	-32768 to 32767	°C	1	F002	0
34FC	RTD Input 13 Value	-32768 to 32767	°C	1	F002	0
34FD	RTD Input 14 Value	-32768 to 32767	°C	1	F002	0
34FE	RTD Input 15 Value	-32768 to 32767	°C	1	F002	0
34FF	RTD Input 16 Value	-32768 to 32767	°C	1	F002	0
3500	RTD Input 17 Value	-32768 to 32767	°C	1	F002	0
3501	RTD Input 18 Value	-32768 to 32767	°C	1	F002	0
3502	RTD Input 19 Value	-32768 to 32767	°C	1	F002	0
3503	RTD Input 20 Value	-32768 to 32767	°C	1	F002	0
3504	RTD Input 21 Value	-32768 to 32767	°C	1	F002	0
3505	RTD Input 22 Value	-32768 to 32767	°C	1	F002	0
3506	RTD Input 23 Value	-32768 to 32767	°C	1	F002	0
3507	RTD Input 24 Value	-32768 to 32767	°C	1	F002	0
3508	RTD Input 25 Value	-32768 to 32767	°C	1	F002	0
3509	RTD Input 26 Value	-32768 to 32767	°C	1	F002	0
350A	RTD Input 27 Value	-32768 to 32767	°C	1	F002	0
350B	RTD Input 28 Value	-32768 to 32767	°C	1	F002	0
350C	RTD Input 29 Value	-32768 to 32767	°C	1	F002	0
350D	RTD Input 30 Value	-32768 to 32767	°C	1	F002	0
350E	RTD Input 31 Value	-32768 to 32767	°C	1	F002	0
350F	RTD Input 32 Value	-32768 to 32767	°C	1	F002	0
3510	RTD Input 33 Value	-32768 to 32767	°C	1	F002	0
3511	RTD Input 34 Value	-32768 to 32767	°C	1	F002	0
3512	RTD Input 35 Value	-32768 to 32767	°C	1	F002	0
3513	RTD Input 36 Value	-32768 to 32767	°C	1	F002	0
3514	RTD Input 37 Value	-32768 to 32767	°C	1	F002	0

B

Table B-9: MODBUS MEMORY MAP (Sheet 10 of 43)

ADDR	REGISTER NAME	RANGE	UNITS	STEP	FORMAT	DEFAULT
3515	RTD Input 38 Value	-32768 to 32767	°C	1	F002	0
3516	RTD Input 39 Value	-32768 to 32767	°C	1	F002	0
3517	RTD Input 40 Value	-32768 to 32767	°C	1	F002	0
3518	RTD Input 41 Value	-32768 to 32767	°C	1	F002	0
3519	RTD Input 42 Value	-32768 to 32767	°C	1	F002	0
351A	RTD Input 43 Value	-32768 to 32767	°C	1	F002	0
351B	RTD Input 44 Value	-32768 to 32767	°C	1	F002	0
351C	RTD Input 45 Value	-32768 to 32767	°C	1	F002	0
351D	RTD Input 46 Value	-32768 to 32767	°C	1	F002	0
351E	RTD Input 47 Value	-32768 to 32767	°C	1	F002	0
351F	RTD Input 48 Value	-32768 to 32767	°C	1	F002	0
Expanded Direct Input/Output Status (Read Only)						
3560	Direct Device States, one per register (8 items)	0 to 1	---	1	F155	0 (Offline)
3570	Direct Input States, one per register (96 items)	0 to 1	---	1	F108	0 (Off)
Passwords (Read/Write Command)						
4000	Command Password Setting	0 to 4294967295	---	1	F003	0
Passwords (Read/Write Setting)						
4002	Setting Password Setting	0 to 4294967295	---	1	F003	0
Passwords (Read/Write)						
4008	Command Password Entry	0 to 4294967295	---	1	F003	0
400A	Setting Password Entry	0 to 4294967295	---	1	F003	0
Passwords (Read Only)						
4010	Command Password Status	0 to 1	---	1	F102	0 (Disabled)
4011	Setting Password Status	0 to 1	---	1	F102	0 (Disabled)
User Display Invoke (Read/Write Setting)						
4040	Invoke and Scroll Through User Display Menu Operand	0 to 65535	---	1	F300	0
LED Test (Read/Write Setting)						
4048	LED Test Function	0 to 1	---	1	F102	0 (Disabled)
4049	LED Test Control	0 to 65535	---	1	F300	0
Preferences (Read/Write Setting)						
404F	Language	0 to 3	---	1	F531	0 (English)
4050	Flash Message Time	0.5 to 10	s	0.1	F001	10
4051	Default Message Timeout	10 to 900	s	1	F001	300
4052	Default Message Intensity	0 to 3	---	1	F101	0 (25%)
4053	Screen Saver Feature	0 to 1	---	1	F102	0 (Disabled)
4054	Screen Saver Wait Time	1 to 65535	min	1	F001	30
4055	Current Cutoff Level	0.002 to 0.02	pu	0.001	F001	20
4056	Voltage Cutoff Level	0.1 to 1	V	0.1	F001	10
Communications (Read/Write Setting)						
407E	COM1 minimum response time	0 to 1000	ms	10	F001	0
407F	COM2 minimum response time	0 to 1000	ms	10	F001	0
4080	Modbus Slave Address	1 to 254	---	1	F001	254
4083	RS485 Com1 Baud Rate	0 to 11	---	1	F112	8 (115200)
4084	RS485 Com1 Parity	0 to 2	---	1	F113	0 (None)
4085	RS485 Com2 Baud Rate	0 to 11	---	1	F112	8 (115200)
4086	RS485 Com2 Parity	0 to 2	---	1	F113	0 (None)
4087	IP Address	0 to 4294967295	---	1	F003	56554706
4089	IP Subnet Mask	0 to 4294967295	---	1	F003	4294966272
408B	Gateway IP Address	0 to 4294967295	---	1	F003	56554497
408D	Network Address NSAP	---	---	---	F074	0
409A	DNP Channel 1 Port	0 to 4	---	1	F177	0 (None)
409B	DNP Channel 2 Port	0 to 4	---	1	F177	0 (None)
409C	DNP Address	0 to 65519	---	1	F001	1
409D	Reserved	0 to 1	---	1	F001	0

Table B-9: MODBUS MEMORY MAP (Sheet 11 of 43)

ADDR	REGISTER NAME	RANGE	UNITS	STEP	FORMAT	DEFAULT
409E	DNP Client Addresses (2 items)	0 to 4294967295	---	1	F003	0
40A3	TCP Port Number for the Modbus protocol	1 to 65535	---	1	F001	502
40A4	TCP/UDP Port Number for the DNP Protocol	1 to 65535	---	1	F001	20000
40A5	TCP Port Number for the HTTP (Web Server) Protocol	1 to 65535	---	1	F001	80
40A6	Main UDP Port Number for the TFTP Protocol	1 to 65535	---	1	F001	69
40A7	Data Transfer UDP Port Numbers for the TFTP Protocol (zero means "automatic") (2 items)	0 to 65535	---	1	F001	0
40A9	DNP Unsolicited Responses Function	0 to 1	---	1	F102	0 (Disabled)
40AA	DNP Unsolicited Responses Timeout	0 to 60	s	1	F001	5
40AB	DNP Unsolicited Responses Max Retries	1 to 255	---	1	F001	10
40AC	DNP Unsolicited Responses Destination Address	0 to 65519	---	1	F001	1
40AD	Ethernet Operation Mode	0 to 1	---	1	F192	0 (Half-Duplex)
40AE	DNP Current Scale Factor	0 to 8	---	1	F194	2 (1)
40AF	DNP Voltage Scale Factor	0 to 8	---	1	F194	2 (1)
40B0	DNP Power Scale Factor	0 to 8	---	1	F194	2 (1)
40B1	DNP Energy Scale Factor	0 to 8	---	1	F194	2 (1)
40B2	DNP Other Scale Factor	0 to 8	---	1	F194	2 (1)
40B3	DNP Current Default Deadband	0 to 65535	---	1	F001	30000
40B4	DNP Voltage Default Deadband	0 to 65535	---	1	F001	30000
40B5	DNP Power Default Deadband	0 to 65535	---	1	F001	30000
40B6	DNP Energy Default Deadband	0 to 65535	---	1	F001	30000
40B7	DNP Other Default Deadband	0 to 65535	---	1	F001	30000
40B8	DNP IIN Time Sync Bit Period	1 to 10080	min	1	F001	1440
40B9	DNP Message Fragment Size	30 to 2048	---	1	F001	240
40BA	DNP Client Address 3	0 to 4294967295	---	1	F003	0
40BC	DNP Client Address 4	0 to 4294967295	---	1	F003	0
40BE	DNP Client Address 5	0 to 4294967295	---	1	F003	0
40C0	DNP Number of Paired Binary Output Control Points	0 to 16	---	1	F001	0
40C1	Reserved (31 items)	0 to 1	---	1	F001	0
40E0	TCP Port Number for the IEC 60870-5-104 Protocol	1 to 65535	---	1	F001	2404
40E1	IEC 60870-5-104 Protocol Function	0 to 1	---	1	F102	0 (Disabled)
40E2	IEC 60870-5-104 Protocol Common Address of ASDU	0 to 65535	---	1	F001	0
40E3	IEC 60870-5-104 Protocol Cyclic Data Trans. Period	1 to 65535	s	1	F001	60
40E4	IEC 60870-5-104 Current Default Threshold	0 to 65535	---	1	F001	30000
40E5	IEC 60870-5-104 Voltage Default Threshold	0 to 65535	---	1	F001	30000
40E6	IEC 60870-5-104 Power Default Threshold	0 to 65535	---	1	F001	30000
40E7	IEC 60870-5-104 Energy Default Threshold	0 to 65535	---	1	F001	30000
40E8	IEC 60870-5-104 Other Default Threshold	0 to 65535	---	1	F001	30000
40E9	IEC 60870-5-104 Client Address (5 items)	0 to 4294967295	---	1	F003	0
40FD	IEC 60870-5-104 Communications Reserved (60 items)	0 to 1	---	1	F001	0
4140	DNP Object 1 Default Variation	1 to 2	---	1	F001	2
4141	DNP Object 2 Default Variation	1 to 2	---	1	F001	2
4142	DNP Object 20 Default Variation	0 to 3	---	1	F523	0 (1)
4143	DNP Object 21 Default Variation	0 to 3	---	1	F524	0 (1)
4144	DNP Object 22 Default Variation	0 to 3	---	1	F523	0 (1)
4145	DNP Object 23 Default Variation	0 to 3	---	1	F523	0 (1)
4146	DNP Object 30 Default Variation	1 to 5	---	1	F001	1
4147	DNP Object 32 Default Variation	0 to 5	---	1	F525	0 (1)
Simple Network Time Protocol (Read/Write Setting)						
4168	Simple Network Time Protocol (SNTP) Function	0 to 1	---	1	F102	0 (Disabled)
4169	Simple Network Time Protocol (SNTP) Server IP Address	0 to 4294967295	---	1	F003	0
416B	Simple Network Time Protocol (SNTP) UDP Port Number	1 to 65535	---	1	F001	123
Data Logger Commands (Read/Write Command)						
4170	Data Logger Clear	0 to 1	---	1	F126	0 (No)

B

Table B-9: MODBUS MEMORY MAP (Sheet 12 of 43)

ADDR	REGISTER NAME	RANGE	UNITS	STEP	FORMAT	DEFAULT
Data Logger (Read/Write Setting)						
4181	Data Logger Channel Settings (16 items)	---	---	---	F600	0
4191	Data Logger Mode	0 to 1	---	1	F260	0 (continuous)
4192	Data Logger Trigger	0 to 65535	---	1	F300	0
4193	Data Logger Rate	15 to 3600000	ms	1	F003	60000
Clock (Read/Write Command)						
41A0	Real Time Clock Set Time	0 to 235959	---	1	F050	0
Clock (Read/Write Setting)						
41A2	SR Date Format	0 to 4294967295	---	1	F051	0
41A4	SR Time Format	0 to 4294967295	---	1	F052	0
41A6	IRIG-B Signal Type	0 to 2	---	1	F114	0 (None)
41A7	Clock Events Enable / Disable	0 to 1	---	1	F102	0 (Disabled)
Oscillography (Read/Write Setting)						
41C0	Oscillography Number of Records	1 to 64	---	1	F001	15
41C1	Oscillography Trigger Mode	0 to 1	---	1	F118	0 (Auto. Overwrite)
41C2	Oscillography Trigger Position	0 to 100	%	1	F001	50
41C3	Oscillography Trigger Source	0 to 65535	---	1	F300	0
41C4	Oscillography AC Input Waveforms	0 to 4	---	1	F183	2 (16 samples/cycle)
41D0	Oscillography Analog Channel <i>n</i> (16 items)	0 to 65535	---	1	F600	0
4200	Oscillography Digital Channel <i>n</i> (63 items)	0 to 65535	---	1	F300	0
Trip and Alarm LEDs (Read/Write Setting)						
4260	Trip LED Input FlexLogic Operand	0 to 65535	---	1	F300	0
4261	Alarm LED Input FlexLogic Operand	0 to 65535	---	1	F300	0
User Programmable LEDs (Read/Write Setting) (48 modules)						
4280	FlexLogic™ Operand to Activate LED	0 to 65535	---	1	F300	0
4281	User LED type (latched or self-resetting)	0 to 1	---	1	F127	1 (Self-Reset)
4282	...Repeated for User-Programmable LED 2					
4284	...Repeated for User-Programmable LED 3					
4286	...Repeated for User-Programmable LED 4					
4288	...Repeated for User-Programmable LED 5					
428A	...Repeated for User-Programmable LED 6					
428C	...Repeated for User-Programmable LED 7					
428E	...Repeated for User-Programmable LED 8					
4290	...Repeated for User-Programmable LED 9					
4292	...Repeated for User-Programmable LED 10					
4294	...Repeated for User-Programmable LED 11					
4296	...Repeated for User-Programmable LED 12					
4298	...Repeated for User-Programmable LED 13					
429A	...Repeated for User-Programmable LED 14					
429C	...Repeated for User-Programmable LED 15					
429E	...Repeated for User-Programmable LED 16					
42A0	...Repeated for User-Programmable LED 17					
42A2	...Repeated for User-Programmable LED 18					
42A4	...Repeated for User-Programmable LED 19					
42A6	...Repeated for User-Programmable LED 20					
42A8	...Repeated for User-Programmable LED 21					
42AA	...Repeated for User-Programmable LED 22					
42AC	...Repeated for User-Programmable LED 23					
42AE	...Repeated for User-Programmable LED 24					
42B0	...Repeated for User-Programmable LED 25					
42B2	...Repeated for User-Programmable LED 26					
42B4	...Repeated for User-Programmable LED 27					
42B6	...Repeated for User-Programmable LED 28					
42B8	...Repeated for User-Programmable LED 29					

B

Table B-9: MODBUS MEMORY MAP (Sheet 13 of 43)

ADDR	REGISTER NAME	RANGE	UNITS	STEP	FORMAT	DEFAULT
42BA	...Repeated for User-Programmable LED 30					
42BC	...Repeated for User-Programmable LED 31					
42BE	...Repeated for User-Programmable LED 32					
42C0	...Repeated for User-Programmable LED 33					
42C2	...Repeated for User-Programmable LED 34					
42C4	...Repeated for User-Programmable LED 35					
42C6	...Repeated for User-Programmable LED 36					
42C8	...Repeated for User-Programmable LED 37					
42CA	...Repeated for User-Programmable LED 38					
42CC	...Repeated for User-Programmable LED 39					
42CE	...Repeated for User-Programmable LED 40					
42D0	...Repeated for User-Programmable LED 41					
42D2	...Repeated for User-Programmable LED 42					
42D4	...Repeated for User-Programmable LED 43					
42D6	...Repeated for User-Programmable LED 44					
42D8	...Repeated for User-Programmable LED 45					
42DA	...Repeated for User-Programmable LED 46					
42DC	...Repeated for User-Programmable LED 47					
42DE	...Repeated for User-Programmable LED 48					
Installation (Read/Write Setting)						
43E0	Relay Programmed State	0 to 1	---	1	F133	0 (Not Programmed)
43E1	Relay Name	---	---	---	F202	"Relay-1"
User Programmable Self Tests (Read/Write Setting)						
4441	User Programmable Detect Ring Break Function	0 to 1	---	1	F102	1 (Enabled)
4442	User Programmable Direct Device Off Function	0 to 1	---	1	F102	1 (Enabled)
4443	User Programmable Remote Device Off Function	0 to 1	---	1	F102	1 (Enabled)
4444	User Programmable Primary Ethernet Fail Function	0 to 1	---	1	F102	0 (Disabled)
4445	User Programmable Secondary Ethernet Fail Function	0 to 1	---	1	F102	0 (Disabled)
4446	User Programmable Battery Fail Function	0 to 1	---	1	F102	1 (Enabled)
4447	User Programmable SNTP Fail Function	0 to 1	---	1	F102	1 (Enabled)
4448	User Programmable IRIG-B Fail Function	0 to 1	---	1	F102	1 (Enabled)
CT Settings (Read/Write Setting) (6 modules)						
4480	Phase CT 1 Primary	1 to 65000	A	1	F001	1
4481	Phase CT 1 Secondary	0 to 1	---	1	F123	0 (1 A)
4482	Ground CT 1 Primary	1 to 65000	A	1	F001	1
4483	Ground CT 1 Secondary	0 to 1	---	1	F123	0 (1 A)
4484	...Repeated for CT Bank 2					
4488	...Repeated for CT Bank 3					
448C	...Repeated for CT Bank 4					
4490	...Repeated for CT Bank 5					
4494	...Repeated for CT Bank 6					
VT Settings (Read/Write Setting) (3 modules)						
4500	Phase VT 1 Connection	0 to 1	---	1	F100	0 (Wye)
4501	Phase VT 1 Secondary	50 to 240	V	0.1	F001	664
4502	Phase VT 1 Ratio	1 to 24000	:1	1	F060	1
4504	Auxiliary VT 1 Connection	0 to 6	---	1	F166	1 (Vag)
4505	Auxiliary VT 1 Secondary	50 to 240	V	0.1	F001	664
4506	Auxiliary VT 1 Ratio	1 to 24000	:1	1	F060	1
4508	...Repeated for VT Bank 2					
4510	...Repeated for VT Bank 3					
Source Settings (Read/Write Setting) (6 modules)						
4580	Source 1 Name	---	---	---	F206	"SRC 1"
4583	Source 1 Phase CT	0 to 63	---	1	F400	0
4584	Source 1 Ground CT	0 to 63	---	1	F400	0

B

Table B-9: MODBUS MEMORY MAP (Sheet 14 of 43)

ADDR	REGISTER NAME	RANGE	UNITS	STEP	FORMAT	DEFAULT
4585	Source 1 Phase VT	0 to 63	---	1	F400	0
4586	Source 1 Auxiliary VT	0 to 63	---	1	F400	0
4587	...Repeated for Source 2					
458E	...Repeated for Source 3					
4595	...Repeated for Source 4					
459C	...Repeated for Source 5					
45A3	...Repeated for Source 6					
Power System (Read/Write Setting)						
4600	Nominal Frequency	25 to 60	Hz	1	F001	60
4601	Phase Rotation	0 to 1	---	1	F106	0 (ABC)
4602	Frequency And Phase Reference	0 to 5	---	1	F167	0 (SRC 1)
4603	Frequency Tracking Function	0 to 1	---	1	F102	1 (Enabled)
Transformer General (Read/Write Setting)						
4630	Transformer Number Of Windings	2 to 6	---	1	F001	2
4631	Transformer Phase Compensation	0 to 1	---	1	F160	0 (Internal (software))
4632	Transformer Load Loss At Rated Load	1 to 20000	kW	1	F001	100
4633	Transformer Rated Winding Temperature Rise	0 to 4	---	1	F161	1 (65°C (oil))
4634	Transformer No Load Loss	1 to 20000	kW	1	F001	10
4635	Transformer Type Of Cooling	0 to 3	---	1	F162	0 (OA)
4636	Transformer Top-oil Rise Over Ambient	1 to 200	°C	1	F001	35
4637	Transformer Thermal Capacity	0 to 200	kWh/°C	0.01	F001	10000
4638	Transformer Winding Thermal Time Constant	0.25 to 15	min	0.01	F001	200
4639	Transformer Reference Winding Manual Selection	0 to 7	---	1	F470	0 (Auto. Selection)
Transformer Winding (Read/Write Setting) (6 modules)						
4640	Transformer Winding 1 Source	0 to 5	---	1	F167	0 (SRC 1)
4641	Transformer Winding 1 Rated MVA	0.001 to 2000	MVA	0.001	F003	100000
4643	Transformer Winding 1 Nominal Phase-Phase Voltage	0.001 to 2000	kV	0.001	F003	220000
4645	Transformer Winding 1 Connection	0 to 2	---	1	F163	0 (Wye)
4646	Transformer Winding 1 Grounding	0 to 1	---	1	F164	0 (Not within zone)
4647	Transformer Winding 1 Angle w.r.t. Winding 1	-359.9 to 0	degrees	0.1	F002	0
4651	Transformer Winding 1 Resistance	0.0001 to 100	ohms	0.0001	F003	100000
4653	...Repeated for Transformer Winding 2					
4666	...Repeated for Transformer Winding 3					
4679	...Repeated for Transformer Winding 4					
468C	...Repeated for Transformer Winding 5					
469F	...Repeated for Transformer Winding 6					
Demand (Read/Write Setting)						
47D0	Demand Current Method	0 to 2	---	1	F139	0 (Thrm. Exponential)
47D1	Demand Power Method	0 to 2	---	1	F139	0 (Thrm. Exponential)
47D2	Demand Interval	0 to 5	---	1	F132	2 (15 MIN)
47D3	Demand Input	0 to 65535	---	1	F300	0
Demand (Read/Write Command)						
47D4	Demand Clear Record	0 to 1	---	1	F126	0 (No)
Flexcurves A and B (Read/Write Settings)						
4800	FlexCurve A (120 items)	0 to 65535	ms	1	F011	0
48F0	FlexCurve B (120 items)	0 to 65535	ms	1	F011	0
Modbus User Map (Read/Write Setting)						
4A00	Modbus Address Settings for User Map (256 items)	0 to 65535	---	1	F001	0
User Displays Settings (Read/Write Setting) (16 modules)						
4C00	User-Definable Display 1 Top Line Text	---	---	---	F202	“ “
4C0A	User-Definable Display 1 Bottom Line Text	---	---	---	F202	“ “
4C14	Modbus Addresses of Display 1 Items (5 items)	0 to 65535	---	1	F001	0
4C19	Reserved (7 items)	---	---	---	F001	0
4C20	...Repeated for User-Definable Display 2					

Table B-9: MODBUS MEMORY MAP (Sheet 15 of 43)

ADDR	REGISTER NAME	RANGE	UNITS	STEP	FORMAT	DEFAULT
4C40	...Repeated for User-Definable Display 3					
4C60	...Repeated for User-Definable Display 4					
4C80	...Repeated for User-Definable Display 5					
4CA0	...Repeated for User-Definable Display 6					
4CC0	...Repeated for User-Definable Display 7					
4CE0	...Repeated for User-Definable Display 8					
4D00	...Repeated for User-Definable Display 9					
4D20	...Repeated for User-Definable Display 10					
4D40	...Repeated for User-Definable Display 11					
4D60	...Repeated for User-Definable Display 12					
4D80	...Repeated for User-Definable Display 13					
4DA0	...Repeated for User-Definable Display 14					
4DC0	...Repeated for User-Definable Display 15					
4DE0	...Repeated for User-Definable Display 16					
User Programmable Pushbuttons (Read/Write Setting) (12 modules)						
4E00	User Programmable Pushbutton 1 Function	0 to 2	---	1	F109	2 (Disabled)
4E01	User Programmable Pushbutton 1 Top Line	---	---	---	F202	(none)
4E0B	User Programmable Pushbutton 1 On Text	---	---	---	F202	(none)
4E15	User Programmable Pushbutton 1 Off Text	---	---	---	F202	(none)
4E1F	User Programmable Pushbutton 1 Drop-Out Time	0 to 60	s	0.05	F001	0
4E20	User Programmable Pushbutton 1 Target	0 to 2	---	1	F109	0 (Self-reset)
4E21	User Programmable Pushbutton 1 Events	0 to 1	---	1	F102	0 (Disabled)
4E22	User Programmable Pushbutton 1 Reserved (2 items)	0 to 65535	---	1	F001	0
4E24	...Repeated for User Programmable Pushbutton 2					
4E48	...Repeated for User Programmable Pushbutton 3					
4E6C	...Repeated for User Programmable Pushbutton 4					
4E90	...Repeated for User Programmable Pushbutton 5					
4EB4	...Repeated for User Programmable Pushbutton 6					
4ED8	...Repeated for User Programmable Pushbutton 7					
4EFC	...Repeated for User Programmable Pushbutton 8					
4F20	...Repeated for User Programmable Pushbutton 9					
4F44	...Repeated for User Programmable Pushbutton 10					
4F68	...Repeated for User Programmable Pushbutton 11					
4F8C	...Repeated for User Programmable Pushbutton 12					
FlexLogic (Read/Write Setting)						
5000	FlexLogic™ Entry (512 items)	0 to 65535	---	1	F300	16384
FlexLogic Timers (Read/Write Setting) (32 modules)						
5800	FlexLogic™ Timer 1 Type	0 to 2	---	1	F129	0 (millisecond)
5801	FlexLogic™ Timer 1 Pickup Delay	0 to 60000	---	1	F001	0
5802	FlexLogic™ Timer 1 Dropout Delay	0 to 60000	---	1	F001	0
5803	Reserved (5 items)	0 to 65535	---	1	F001	0
5808	...Repeated for FlexLogic™ Timer 2					
5810	...Repeated for FlexLogic™ Timer 3					
5818	...Repeated for FlexLogic™ Timer 4					
5820	...Repeated for FlexLogic™ Timer 5					
5828	...Repeated for FlexLogic™ Timer 6					
5830	...Repeated for FlexLogic™ Timer 7					
5838	...Repeated for FlexLogic™ Timer 8					
5840	...Repeated for FlexLogic™ Timer 9					
5848	...Repeated for FlexLogic™ Timer 10					
5850	...Repeated for FlexLogic™ Timer 11					
5858	...Repeated for FlexLogic™ Timer 12					
5860	...Repeated for FlexLogic™ Timer 13					
5868	...Repeated for FlexLogic™ Timer 14					

B

Table B-9: MODBUS MEMORY MAP (Sheet 16 of 43)

ADDR	REGISTER NAME	RANGE	UNITS	STEP	FORMAT	DEFAULT
5870	...Repeated for FlexLogic™ Timer 15					
5878	...Repeated for FlexLogic™ Timer 16					
5880	...Repeated for FlexLogic™ Timer 17					
5888	...Repeated for FlexLogic™ Timer 18					
5890	...Repeated for FlexLogic™ Timer 19					
5898	...Repeated for FlexLogic™ Timer 20					
58A0	...Repeated for FlexLogic™ Timer 21					
58A8	...Repeated for FlexLogic™ Timer 22					
58B0	...Repeated for FlexLogic™ Timer 23					
58B8	...Repeated for FlexLogic™ Timer 24					
58C0	...Repeated for FlexLogic™ Timer 25					
58C8	...Repeated for FlexLogic™ Timer 26					
58D0	...Repeated for FlexLogic™ Timer 27					
58D8	...Repeated for FlexLogic™ Timer 28					
58E0	...Repeated for FlexLogic™ Timer 29					
58E8	...Repeated for FlexLogic™ Timer 30					
58F0	...Repeated for FlexLogic™ Timer 31					
58F8	...Repeated for FlexLogic™ Timer 32					
Phase Time Overcurrent (Read/Write Grouped Setting) (6 modules)						
5900	Phase Time Overcurrent 1 Function	0 to 1	---	1	F102	0 (Disabled)
5901	Phase Time Overcurrent 1 Signal Source	0 to 5	---	1	F167	0 (SRC 1)
5902	Phase Time Overcurrent 1 Input	0 to 1	---	1	F122	0 (Phasor)
5903	Phase Time Overcurrent 1 Pickup	0 to 30	pu	0.001	F001	1000
5904	Phase Time Overcurrent 1 Curve	0 to 16	---	1	F103	0 (IEEE Mod Inv)
5905	Phase Time Overcurrent 1 Multiplier	0 to 600	---	0.01	F001	100
5906	Phase Time Overcurrent 1 Reset	0 to 1	---	1	F104	0 (Instantaneous)
5907	Phase Time Overcurrent 1 Voltage Restraint	0 to 1	---	1	F102	0 (Disabled)
5908	Phase TOC 1 Block For Each Phase (3 items)	0 to 65535	---	1	F300	0
590B	Phase Time Overcurrent 1 Target	0 to 2	---	1	F109	0 (Self-reset)
590C	Phase Time Overcurrent 1 Events	0 to 1	---	1	F102	0 (Disabled)
590D	Reserved (3 items)	0 to 1	---	1	F001	0
5910	...Repeated for Phase Time Overcurrent 2					
5920	...Repeated for Phase Time Overcurrent 3					
5930	...Repeated for Phase Time Overcurrent 4					
5940	...Repeated for Phase Time Overcurrent 5					
5950	...Repeated for Phase Time Overcurrent 6					
Phase Instantaneous Overcurrent (Read/Write Grouped Setting) (12 modules)						
5A00	Phase Instantaneous Overcurrent 1 Function	0 to 1	---	1	F102	0 (Disabled)
5A01	Phase Instantaneous Overcurrent 1 Signal Source	0 to 5	---	1	F167	0 (SRC 1)
5A02	Phase Instantaneous Overcurrent 1 Pickup	0 to 30	pu	0.001	F001	1000
5A03	Phase Instantaneous Overcurrent 1 Delay	0 to 600	s	0.01	F001	0
5A04	Phase Instantaneous Overcurrent 1 Reset Delay	0 to 600	s	0.01	F001	0
5A05	Phase IOC1 Block For Each Phase (3 items)	0 to 65535	---	1	F300	0
5A08	Phase Instantaneous Overcurrent 1 Target	0 to 2	---	1	F109	0 (Self-reset)
5A09	Phase Instantaneous Overcurrent 1 Events	0 to 1	---	1	F102	0 (Disabled)
5A0A	Reserved (6 items)	0 to 1	---	1	F001	0
5A10	...Repeated for Phase Instantaneous Overcurrent 2					
5A20	...Repeated for Phase Instantaneous Overcurrent 3					
5A30	...Repeated for Phase Instantaneous Overcurrent 4					
5A40	...Repeated for Phase Instantaneous Overcurrent 5					
5A50	...Repeated for Phase Instantaneous Overcurrent 6					
5A60	...Repeated for Phase Instantaneous Overcurrent 7					
5A70	...Repeated for Phase Instantaneous Overcurrent 8					
5A80	...Repeated for Phase Instantaneous Overcurrent 9					

B

Table B-9: MODBUS MEMORY MAP (Sheet 17 of 43)

ADDR	REGISTER NAME	RANGE	UNITS	STEP	FORMAT	DEFAULT
5A90	...Repeated for Phase Instantaneous Overcurrent 10					
5AA0	...Repeated for Phase Instantaneous Overcurrent 11					
5AB0	...Repeated for Phase Instantaneous Overcurrent 12					
Neutral Time Overcurrent (Read/Write Grouped Setting) (6 modules)						
5B00	Neutral Time Overcurrent 1 Function	0 to 1	---	1	F102	0 (Disabled)
5B01	Neutral Time Overcurrent 1 Signal Source	0 to 5	---	1	F167	0 (SRC 1)
5B02	Neutral Time Overcurrent 1 Input	0 to 1	---	1	F122	0 (Phasor)
5B03	Neutral Time Overcurrent 1 Pickup	0 to 30	pu	0.001	F001	1000
5B04	Neutral Time Overcurrent 1 Curve	0 to 16	---	1	F103	0 (IEEE Mod Inv)
5B05	Neutral Time Overcurrent 1 Multiplier	0 to 600	---	0.01	F001	100
5B06	Neutral Time Overcurrent 1 Reset	0 to 1	---	1	F104	0 (Instantaneous)
5B07	Neutral Time Overcurrent 1 Block	0 to 65535	---	1	F300	0
5B08	Neutral Time Overcurrent 1 Target	0 to 2	---	1	F109	0 (Self-reset)
5B09	Neutral Time Overcurrent 1 Events	0 to 1	---	1	F102	0 (Disabled)
5B0A	Reserved (6 items)	0 to 1	---	1	F001	0
5B10	...Repeated for Neutral Time Overcurrent 2					
5B20	...Repeated for Neutral Time Overcurrent 3					
5B30	...Repeated for Neutral Time Overcurrent 4					
5B40	...Repeated for Neutral Time Overcurrent 5					
5B50	...Repeated for Neutral Time Overcurrent 6					
Neutral Instantaneous Overcurrent (Read/Write Grouped Setting) (12 modules)						
5C00	Neutral Instantaneous Overcurrent 1 Function	0 to 1	---	1	F102	0 (Disabled)
5C01	Neutral Instantaneous Overcurrent 1 Signal Source	0 to 5	---	1	F167	0 (SRC 1)
5C02	Neutral Instantaneous Overcurrent 1 Pickup	0 to 30	pu	0.001	F001	1000
5C03	Neutral Instantaneous Overcurrent 1 Delay	0 to 600	s	0.01	F001	0
5C04	Neutral Instantaneous Overcurrent 1 Reset Delay	0 to 600	s	0.01	F001	0
5C05	Neutral Instantaneous Overcurrent 1 Block	0 to 65535	---	1	F300	0
5C06	Neutral Instantaneous Overcurrent 1 Target	0 to 2	---	1	F109	0 (Self-reset)
5C07	Neutral Instantaneous Overcurrent 1 Events	0 to 1	---	1	F102	0 (Disabled)
5C08	Reserved (8 items)	0 to 1	---	1	F001	0
5C10	...Repeated for Neutral Instantaneous Overcurrent 2					
5C20	...Repeated for Neutral Instantaneous Overcurrent 3					
5C30	...Repeated for Neutral Instantaneous Overcurrent 4					
5C40	...Repeated for Neutral Instantaneous Overcurrent 5					
5C50	...Repeated for Neutral Instantaneous Overcurrent 6					
5C60	...Repeated for Neutral Instantaneous Overcurrent 7					
5C70	...Repeated for Neutral Instantaneous Overcurrent 8					
5C80	...Repeated for Neutral Instantaneous Overcurrent 9					
5C90	...Repeated for Neutral Instantaneous Overcurrent 10					
5CA0	...Repeated for Neutral Instantaneous Overcurrent 11					
5CB0	...Repeated for Neutral Instantaneous Overcurrent 12					
Ground Time Overcurrent (Read/Write Grouped Setting) (6 modules)						
5D00	Ground Time Overcurrent 1 Function	0 to 1	---	1	F102	0 (Disabled)
5D01	Ground Time Overcurrent 1 Signal Source	0 to 5	---	1	F167	0 (SRC 1)
5D02	Ground Time Overcurrent 1 Input	0 to 1	---	1	F122	0 (Phasor)
5D03	Ground Time Overcurrent 1 Pickup	0 to 30	pu	0.001	F001	1000
5D04	Ground Time Overcurrent 1 Curve	0 to 16	---	1	F103	0 (IEEE Mod Inv)
5D05	Ground Time Overcurrent 1 Multiplier	0 to 600	---	0.01	F001	100
5D06	Ground Time Overcurrent 1 Reset	0 to 1	---	1	F104	0 (Instantaneous)
5D07	Ground Time Overcurrent 1 Block	0 to 65535	---	1	F300	0
5D08	Ground Time Overcurrent 1 Target	0 to 2	---	1	F109	0 (Self-reset)
5D09	Ground Time Overcurrent 1 Events	0 to 1	---	1	F102	0 (Disabled)
5D0A	Reserved (6 items)	0 to 1	---	1	F001	0
5D10	...Repeated for Ground Time Overcurrent 2					

Table B-9: MODBUS MEMORY MAP (Sheet 18 of 43)

ADDR	REGISTER NAME	RANGE	UNITS	STEP	FORMAT	DEFAULT
5D20	...Repeated for Ground Time Overcurrent 3					
5D30	...Repeated for Ground Time Overcurrent 4					
5D40	...Repeated for Ground Time Overcurrent 5					
5D50	...Repeated for Ground Time Overcurrent 6					
Ground Instantaneous Overcurrent (Read/Write Grouped Setting) (12 modules)						
5E00	Ground Instantaneous Overcurrent 1 Signal Source	0 to 5	---	1	F167	0 (SRC 1)
5E01	Ground Instantaneous Overcurrent 1 Function	0 to 1	---	1	F102	0 (Disabled)
5E02	Ground Instantaneous Overcurrent 1 Pickup	0 to 30	pu	0.001	F001	1000
5E03	Ground Instantaneous Overcurrent 1 Delay	0 to 600	s	0.01	F001	0
5E04	Ground Instantaneous Overcurrent 1 Reset Delay	0 to 600	s	0.01	F001	0
5E05	Ground Instantaneous Overcurrent 1 Block	0 to 65535	---	1	F300	0
5E06	Ground Instantaneous Overcurrent 1 Target	0 to 2	---	1	F109	0 (Self-reset)
5E07	Ground Instantaneous Overcurrent 1 Events	0 to 1	---	1	F102	0 (Disabled)
5E08	Reserved (8 items)	0 to 1	---	1	F001	0
5E10	...Repeated for Ground Instantaneous Overcurrent 2					
5E20	...Repeated for Ground Instantaneous Overcurrent 3					
5E30	...Repeated for Ground Instantaneous Overcurrent 4					
5E40	...Repeated for Ground Instantaneous Overcurrent 5					
5E50	...Repeated for Ground Instantaneous Overcurrent 6					
5E60	...Repeated for Ground Instantaneous Overcurrent 7					
5E70	...Repeated for Ground Instantaneous Overcurrent 8					
5E80	...Repeated for Ground Instantaneous Overcurrent 9					
5E90	...Repeated for Ground Instantaneous Overcurrent 10					
5EA0	...Repeated for Ground Instantaneous Overcurrent 11					
5EB0	...Repeated for Ground Instantaneous Overcurrent 12					
Setting Groups (Read/Write Setting)						
5F80	Setting Group for Modbus Comms (0 means group 1)	0 to 5	---	1	F001	0
5F81	Setting Groups Block	0 to 65535	---	1	F300	0
5F82	FlexLogic to Activate Groups 2 through 6 (5 items)	0 to 65535	---	1	F300	0
5F89	Setting Group Function	0 to 1	---	1	F102	0 (Disabled)
5F8A	Setting Group Events	0 to 1	---	1	F102	0 (Disabled)
Setting Groups (Read Only)						
5F8B	Current Setting Group	0 to 5	---	1	F001	0
Setting Group Names (Read/Write Setting)						
5F8C	Setting Group 1 Name	---	---	---	F203	(none)
5494	Setting Group 2 Name	---	---	---	F203	(none)
5F9C	Setting Group 3 Name	---	---	---	F203	(none)
5FA4	Setting Group 4 Name	---	---	---	F203	(none)
5FAC	Setting Group 5 Name	---	---	---	F203	(none)
5FB4	Setting Group 6 Name	---	---	---	F203	(none)
Transformer Hottest Spot (Read/Write Grouped Setting)						
6140	Transformer Hottest Spot Function	0 to 1	---	1	F102	0 (Disabled)
6141	Transformer Hottest Spot Pickup	50 to 300	× C	1	F001	140
6142	Transformer Hottest Spot Delay	0 to 30000	min	1	F001	1
6143	Transformer Hottest Spot Block	0 to 65535	---	1	F300	0
6144	Transformer Hottest Spot Target	0 to 2	---	1	F109	0 (Self-reset)
6145	Transformer Hottest Spot Events	0 to 1	---	1	F102	0 (Disabled)
Transformer Aging Factor (Read/Write Grouped Setting)						
6150	Transformer Aging Factor Function	0 to 1	---	1	F102	0 (Disabled)
6151	Transformer Aging Factor Pickup	1 to 10	PU	0.1	F001	20
6152	Transformer Aging Factor Delay	0 to 30000	min	1	F001	10
6153	Transformer Aging Factor BLock	0 to 65535	---	1	F300	0
6154	Transformer Aging Factor Target	0 to 2	---	1	F109	0 (Self-reset)
6155	Transformer Aging Factor Events	0 to 1	---	1	F102	0 (Disabled)

B

Table B-9: MODBUS MEMORY MAP (Sheet 19 of 43)

ADDR	REGISTER NAME	RANGE	UNITS	STEP	FORMAT	DEFAULT
Transformer Loss of Life (Read/Write Grouped Setting)						
6160	Transformer Loss of Life Function	0 to 1	---	1	F102	0 (Disabled)
6161	XFMR LOL Initial Value	0 to 500000	hrs	1	F003	0
6163	Transformer Loss of Life Pickup	0 to 500000	hrs	1	F003	180000
6165	Transformer Loss Of Life Block	0 to 65535	---	1	F300	0
6166	Transformer Loss of Life Target	0 to 2	---	1	F109	0 (Self-reset)
6167	Transformer Loss of Life Events	0 to 1	---	1	F102	0 (Disabled)
Transformer Thermal Inputs (Read/Write Setting)						
6170	Transformer Thermal Model Source Input	0 to 5	---	1	F167	0 (SRC 1)
6171	Ambient Temperature Input Sensor	0 to 32	---	1	F450	0
6172	Top Oil Temperature Input Sensor	0 to 32	---	1	F460	0
6173	January Average Ambient Temperature	-60 to 60	---	1	F002	-20
6174	February Average Ambient Temperature	-60 to 60	---	1	F002	-30
6175	March Average Ambient Temperature	-60 to 60	---	1	F002	-10
6176	April Average Ambient Temperature	-60 to 60	---	1	F002	10
6177	May Average Ambient Temperature	-60 to 60	---	1	F002	20
6178	June Average Ambient Temperature	-60 to 60	---	1	F002	30
6179	July Average Ambient Temperature	-60 to 60	---	1	F002	30
617A	August Average Ambient Temperature	-60 to 60	---	1	F002	30
617B	September Average Ambient Temperature	-60 to 60	---	1	F002	20
617C	October Average Ambient Temperature	-60 to 60	---	1	F002	10
617D	November Average Ambient Temperature	-60 to 60	---	1	F002	10
617E	December Average Ambient Temperature	-60 to 60	---	1	F002	-10
Transformer Loss of Life (Read/Write Command)						
6180	Transformer Loss of Life Clear Command	0 to 1	---	1	F126	0 (No)
Transformer Percent Differential (Read/Write Grouped Setting)						
6200	Percent Differential Function	0 to 1	---	1	F102	0 (Disabled)
6201	Percent Differential Pickup	0.05 to 1	pu	0.001	F001	100
6202	Percent Differential Slope 1	15 to 100	%	1	F001	25
6203	Percent Differential Break 1	1 to 2	pu	0.001	F001	2000
6204	Percent Differential Break 2	2 to 30	pu	0.001	F001	8000
6205	Percent Differential Slope 2	50 to 100	%	1	F001	100
6206	Inrush Inhibit Function	0 to 2	---	1	F168	1 (Adapt. 2nd)
6207	Inrush Inhibit Level	1 to 40	% fo	0.1	F001	200
6208	Overexcitation Inhibit Function	0 to 1	---	1	F169	0 (Disabled)
6209	Overexcitation Inhibit Level	1 to 40	% fo	0.1	F001	100
620A	Percent Differential Block	0 to 65535	---	1	F300	0
620B	Percent Differential Target	0 to 2	---	1	F109	0 (Self-reset)
620C	Percent Differential Events	0 to 1	---	1	F102	0 (Disabled)
620D	Transformer Inrush Inhibit Mode	0 to 2	---	1	F189	0 (Per phase)
Transformer Instantaneous Differential (Read/Write Grouped Setting)						
6220	Transformer Instantaneous Differential Function	0 to 1	---	1	F102	0 (Disabled)
6221	Transformer Instantaneous Differential Pickup	2 to 30	pu	0.001	F001	8000
6222	Transformer Instantaneous Differential Block	0 to 65535	---	1	F300	0
6223	Transformer Instantaneous Differential Target	0 to 2	---	1	F109	0 (Self-reset)
6224	Transformer Instantaneous Differential Events	0 to 1	---	1	F102	0 (Disabled)
Overfrequency (Read/Write Setting) (4 modules)						
64D0	Overfrequency 1 Function	0 to 1	---	1	F102	0 (Disabled)
64D1	Overfrequency 1 Block	0 to 65535	---	1	F300	0
64D2	Overfrequency 1 Source	0 to 5	---	1	F167	0 (SRC 1)
64D3	Overfrequency 1 Pickup	20 to 65	Hz	0.01	F001	6050
64D4	Overfrequency 1 Pickup Delay	0 to 65.535	s	0.001	F001	500
64D5	Overfrequency 1 Reset Delay	0 to 65.535	s	0.001	F001	500
64D6	Overfrequency 1 Target	0 to 2	---	1	F109	0 (Self-reset)

Table B-9: MODBUS MEMORY MAP (Sheet 20 of 43)

ADDR	REGISTER NAME	RANGE	UNITS	STEP	FORMAT	DEFAULT
64D7	Overfrequency 1 Events	0 to 1	---	1	F102	0 (Disabled)
64D8	Reserved (4 items)	0 to 1	---	1	F001	0
64DC	...Repeated for Overfrequency 2					
64E8	...Repeated for Overfrequency 3					
64F4	...Repeated for Overfrequency 4					
Phase Undervoltage (Read/Write Grouped Setting) (2 modules)						
7000	Phase Undervoltage 1 Function	0 to 1	---	1	F102	0 (Disabled)
7001	Phase Undervoltage 1 Signal Source	0 to 5	---	1	F167	0 (SRC 1)
7002	Phase Undervoltage 1 Pickup	0 to 3	pu	0.001	F001	1000
7003	Phase Undervoltage 1 Curve	0 to 1	---	1	F111	0 (Definite Time)
7004	Phase Undervoltage 1 Delay	0 to 600	s	0.01	F001	100
7005	Phase Undervoltage 1 Minimum Voltage	0 to 3	pu	0.001	F001	100
7006	Phase Undervoltage 1 Block	0 to 65535	---	1	F300	0
7007	Phase Undervoltage 1 Target	0 to 2	---	1	F109	0 (Self-reset)
7008	Phase Undervoltage 1 Events	0 to 1	---	1	F102	0 (Disabled)
7009	Phase Undervoltage 1 Measurement Mode	0 to 1	---	1	F186	0 (Phase to Ground)
700A	Reserved (6 items)	0 to 1	---	1	F001	0
7013	...Repeated for Phase Undervoltage 2					
Phase Overvoltage (Read/Write Grouped Setting)						
7040	Phase Overvoltage 1 Function	0 to 1	---	1	F102	0 (Disabled)
7041	Phase Overvoltage 1 Source	0 to 5	---	1	F167	0 (SRC 1)
7042	Phase Overvoltage 1 Pickup	0 to 3	pu	0.001	F001	1000
7043	Phase Overvoltage 1 Delay	0 to 600	s	0.01	F001	100
7044	Phase Overvoltage 1 Reset Delay	0 to 600	s	0.01	F001	100
7045	Phase Overvoltage 1 Block	0 to 65535	---	1	F300	0
7046	Phase Overvoltage 1 Target	0 to 2	---	1	F109	0 (Self-reset)
7047	Phase Overvoltage 1 Events	0 to 1	---	1	F102	0 (Disabled)
7048	Reserved (8 items)	0 to 1	---	1	F001	0
Phase Directional Overcurrent (Read/Write Grouped Setting) (2 modules)						
7260	Phase Directional Overcurrent 1 Function	0 to 1	---	1	F102	0 (Disabled)
7261	Phase Directional Overcurrent 1 Source	0 to 5	---	1	F167	0 (SRC 1)
7262	Phase Directional Overcurrent 1 Block	0 to 65535	---	1	F300	0
7263	Phase Directional Overcurrent 1 ECA	0 to 359	---	1	F001	30
7264	Phase Directional Overcurrent 1 Pol V Threshold	0 to 3	pu	0.001	F001	700
7265	Phase Directional Overcurrent 1 Block Overcurrent	0 to 1	---	1	F126	0 (No)
7266	Phase Directional Overcurrent 1 Target	0 to 2	---	1	F109	0 (Self-reset)
7267	Phase Directional Overcurrent 1 Events	0 to 1	---	1	F102	0 (Disabled)
7268	Reserved (8 items)	0 to 1	---	1	F001	0
7270	...Repeated for Phase Directional Overcurrent 2					
Neutral Directional Overcurrent (Read/Write Grouped Setting) (2 modules)						
7280	Neutral Directional Overcurrent 1 Function	0 to 1	---	1	F102	0 (Disabled)
7281	Neutral Directional Overcurrent 1 Source	0 to 5	---	1	F167	0 (SRC 1)
7282	Neutral Directional Overcurrent 1 Polarizing	0 to 2	---	1	F230	0 (Voltage)
7283	Neutral Directional Overcurrent 1 Forward ECA	-90 to 90	° Lag	1	F002	75
7284	Neutral Directional Overcurrent 1 Forward Limit Angle	40 to 90	degrees	1	F001	90
7285	Neutral Directional Overcurrent 1 Forward Pickup	0.002 to 30	pu	0.001	F001	50
7286	Neutral Directional Overcurrent 1 Reverse Limit Angle	40 to 90	degrees	1	F001	90
7287	Neutral Directional Overcurrent 1 Reverse Pickup	0.002 to 30	pu	0.001	F001	50
7288	Neutral Directional Overcurrent 1 Target	0 to 2	---	1	F109	0 (Self-reset)
7289	Neutral Directional Overcurrent 1 Block	0 to 65535	---	1	F300	0
728A	Neutral Directional Overcurrent 1 Events	0 to 1	---	1	F102	0 (Disabled)
728B	Neutral Directional Overcurrent 1 Polarizing Voltage	0 to 1	---	1	F231	0 (Calculated V0)
728C	Neutral Directional Overcurrent 1 Op Current	0 to 1	---	1	F196	0 (Calculated 3I0)
728D	Neutral Directional Overcurrent 1 Offset	0 to 250	ohms	0.01	F001	0

Table B-9: MODBUS MEMORY MAP (Sheet 21 of 43)

ADDR	REGISTER NAME	RANGE	UNITS	STEP	FORMAT	DEFAULT
728E	Neutral Directional Overcurrent 1 Pos Seq Restraint	0 to 0.5	---	0.001	F001	63
728F	Reserved	0 to 1	---	1	F001	0
7290	...Repeated for Neutral Directional Overcurrent 2					
Breaker Arcing Current Settings (Read/Write Setting) (2 modules)						
72C0	Breaker 1 Arcing Current Function	0 to 1	---	1	F102	0 (Disabled)
72C1	Breaker 1 Arcing Current Source	0 to 5	---	1	F167	0 (SRC 1)
72C2	Breaker 1 Arcing Current Initiate A	0 to 65535	---	1	F300	0
72C3	Breaker 1 Arcing Current Initiate B	0 to 65535	---	1	F300	0
72C4	Breaker 1 Arcing Current Initiate C	0 to 65535	---	1	F300	0
72C5	Breaker 1 Arcing Current Delay	0 to 65.535	s	0.001	F001	0
72C6	Breaker 1 Arcing Current Limit	0 to 50000	kA ² -cyc	1	F001	1000
72C7	Breaker 1 Arcing Current Block	0 to 65535	---	1	F300	0
72C8	Breaker 1 Arcing Current Target	0 to 2	---	1	F109	0 (Self-reset)
72C9	Breaker 1 Arcing Current Events	0 to 1	---	1	F102	0 (Disabled)
72CA	...Repeated for Breaker 2 Arcing Current					
72D4	...Repeated for Breaker 3 Arcing Current					
72DE	...Repeated for Breaker 4 Arcing Current					
DCMA Inputs (Read/Write Setting) (24 modules)						
7300	dcmA Inputs 1 Function	0 to 1	---	1	F102	0 (Disabled)
7301	dcmA Inputs 1 ID	---	---	---	F205	"DCMA I 1"
7307	Reserved 1 (4 items)	0 to 65535	---	1	F001	0
730B	dcmA Inputs 1 Units	---	---	---	F206	"mA"
730E	dcmA Inputs 1 Range	0 to 6	---	1	F173	6 (4 to 20 mA)
730F	dcmA Inputs 1 Minimum Value	-9999.999 to 9999.999	---	0.001	F004	4000
7311	dcmA Inputs 1 Maximum Value	-9999.999 to 9999.999	---	0.001	F004	20000
7313	Reserved (5 items)	0 to 65535	---	1	F001	0
7318	...Repeated for dcmA Inputs 2					
7330	...Repeated for dcmA Inputs 3					
7348	...Repeated for dcmA Inputs 4					
7360	...Repeated for dcmA Inputs 5					
7378	...Repeated for dcmA Inputs 6					
7390	...Repeated for dcmA Inputs 7					
73A8	...Repeated for dcmA Inputs 8					
73C0	...Repeated for dcmA Inputs 9					
73D8	...Repeated for dcmA Inputs 10					
73F0	...Repeated for dcmA Inputs 11					
7408	...Repeated for dcmA Inputs 12					
7420	...Repeated for dcmA Inputs 13					
7438	...Repeated for dcmA Inputs 14					
7450	...Repeated for dcmA Inputs 15					
7468	...Repeated for dcmA Inputs 16					
7480	...Repeated for dcmA Inputs 17					
7498	...Repeated for dcmA Inputs 18					
74B0	...Repeated for dcmA Inputs 19					
74C8	...Repeated for dcmA Inputs 20					
74E0	...Repeated for dcmA Inputs 21					
74F8	...Repeated for dcmA Inputs 22					
7510	...Repeated for dcmA Inputs 23					
7528	...Repeated for dcmA Inputs 24					
RTD Inputs (Read/Write Setting) (48 modules)						
7540	RTD Input 1 Function	0 to 1	---	1	F102	0 (Disabled)
7541	RTD Input 1 ID	---	---	---	F205	"RTD Ip 1"
7547	Reserved (4 items)	0 to 65535	---	1	F001	0
754B	RTD Input 1 Type	0 to 3	---	1	F174	0 (100 Ohm Platinum)

B

Table B-9: MODBUS MEMORY MAP (Sheet 22 of 43)

ADDR	REGISTER NAME	RANGE	UNITS	STEP	FORMAT	DEFAULT
754C	Reserved (4 items)	0 to 65535	---	1	F001	0
7550	...Repeated for RTD Input 2					
7560	...Repeated for RTD Input 3					
7570	...Repeated for RTD Input 4					
7580	...Repeated for RTD Input 5					
7590	...Repeated for RTD Input 6					
75A0	...Repeated for RTD Input 7					
75B0	...Repeated for RTD Input 8					
75C0	...Repeated for RTD Input 9					
75D0	...Repeated for RTD Input 10					
75E0	...Repeated for RTD Input 11					
75F0	...Repeated for RTD Input 12					
7600	...Repeated for RTD Input 13					
7610	...Repeated for RTD Input 14					
7620	...Repeated for RTD Input 15					
7630	...Repeated for RTD Input 16					
7640	...Repeated for RTD Input 17					
7650	...Repeated for RTD Input 18					
7660	...Repeated for RTD Input 19					
7670	...Repeated for RTD Input 20					
7680	...Repeated for RTD Input 21					
7690	...Repeated for RTD Input 22					
76A0	...Repeated for RTD Input 23					
76B0	...Repeated for RTD Input 24					
76C0	...Repeated for RTD Input 25					
76D0	...Repeated for RTD Input 26					
76E0	...Repeated for RTD Input 27					
76F0	...Repeated for RTD Input 28					
7700	...Repeated for RTD Input 29					
7710	...Repeated for RTD Input 30					
7720	...Repeated for RTD Input 31					
7730	...Repeated for RTD Input 32					
7740	...Repeated for RTD Input 33					
7750	...Repeated for RTD Input 34					
7760	...Repeated for RTD Input 35					
7770	...Repeated for RTD Input 36					
7780	...Repeated for RTD Input 37					
7790	...Repeated for RTD Input 38					
77A0	...Repeated for RTD Input 39					
77B0	...Repeated for RTD Input 40					
77C0	...Repeated for RTD Input 41					
77D0	...Repeated for RTD Input 42					
77E0	...Repeated for RTD Input 43					
77F0	...Repeated for RTD Input 44					
7800	...Repeated for RTD Input 45					
7810	...Repeated for RTD Input 46					
7820	...Repeated for RTD Input 47					
7830	...Repeated for RTD Input 48					
Underfrequency (Read/Write Setting) (6 modules)						
7E00	Underfrequency Function	0 to 1	---	1	F102	0 (Disabled)
7E01	Underfrequency 1 Block	0 to 65535	---	1	F300	0
7E02	Underfrequency 1 Minimum Current	0.1 to 1.25	pu	0.01	F001	10
7E03	Underfrequency 1 Pickup	20 to 65	Hz	0.01	F001	5950
7E04	Underfrequency 1 Pickup Delay	0 to 65.535	s	0.001	F001	2000

B

Table B-9: MODBUS MEMORY MAP (Sheet 23 of 43)

ADDR	REGISTER NAME	RANGE	UNITS	STEP	FORMAT	DEFAULT
7E05	Underfrequency 1 Reset Delay	0 to 65.535	s	0.001	F001	2000
7E06	Underfrequency 1 Source	0 to 5	---	1	F167	0 (SRC 1)
7E07	Underfrequency 1 Events	0 to 1	---	1	F102	0 (Disabled)
7E08	Underfrequency 1 Target	0 to 2	---	1	F109	0 (Self-reset)
7E09	Reserved (8 items)	0 to 1	---	1	F001	0
7E11	...Repeated for Underfrequency 2					
7E22	...Repeated for Underfrequency 3					
7E33	...Repeated for Underfrequency 4					
7E44	...Repeated for Underfrequency 5					
7E55	...Repeated for Underfrequency 6					
Neutral Overvoltage (Read/Write Grouped Setting) (3 modules)						
7F00	Neutral Overvoltage 1 Function	0 to 1	---	1	F102	0 (Disabled)
7F01	Neutral Overvoltage 1 Signal Source	0 to 5	---	1	F167	0 (SRC 1)
7F02	Neutral Overvoltage 1 Pickup	0 to 1.25	pu	0.001	F001	300
7F03	Neutral Overvoltage 1 Pickup Delay	0 to 600	s	0.01	F001	100
7F04	Neutral Overvoltage 1 Reset Delay	0 to 600	s	0.01	F001	100
7F05	Neutral Overvoltage 1 Block	0 to 65535	---	1	F300	0
7F06	Neutral Overvoltage 1 Target	0 to 2	---	1	F109	0 (Self-reset)
7F07	Neutral Overvoltage 1 Events	0 to 1	---	1	F102	0 (Disabled)
7F08	Reserved (8 items)	0 to 65535	---	1	F001	0
7F10	...Repeated for Neutral Overvoltage 2					
7F20	...Repeated for Neutral Overvoltage 3					
Auxiliary Overvoltage (Read/Write Grouped Setting) (3 modules)						
7F30	Auxiliary Overvoltage 1 Function	0 to 1	---	1	F102	0 (Disabled)
7F31	Auxiliary Overvoltage 1 Signal Source	0 to 5	---	1	F167	0 (SRC 1)
7F32	Auxiliary Overvoltage 1 Pickup	0 to 3	pu	0.001	F001	300
7F33	Auxiliary Overvoltage 1 Pickup Delay	0 to 600	s	0.01	F001	100
7F34	Auxiliary Overvoltage 1 Reset Delay	0 to 600	s	0.01	F001	100
7F35	Auxiliary Overvoltage 1 Block	0 to 65535	---	1	F300	0
7F36	Auxiliary Overvoltage 1 Target	0 to 2	---	1	F109	0 (Self-reset)
7F37	Auxiliary Overvoltage 1 Events	0 to 1	---	1	F102	0 (Disabled)
7F38	Reserved (8 items)	0 to 65535	---	1	F001	0
7F40	...Repeated for Auxiliary Overvoltage 2					
7F50	...Repeated for Auxiliary Overvoltage 3					
Auxiliary Undervoltage (Read/Write Grouped Setting) (3 modules)						
7F60	Auxiliary Undervoltage 1 Function	0 to 1	---	1	F102	0 (Disabled)
7F61	Auxiliary Undervoltage 1 Signal Source	0 to 5	---	1	F167	0 (SRC 1)
7F62	Auxiliary Undervoltage 1 Pickup	0 to 3	pu	0.001	F001	700
7F63	Auxiliary Undervoltage 1 Delay	0 to 600	s	0.01	F001	100
7F64	Auxiliary Undervoltage 1 Curve	0 to 1	---	1	F111	0 (Definite Time)
7F65	Auxiliary Undervoltage 1 Minimum Voltage	0 to 3	pu	0.001	F001	100
7F66	Auxiliary Undervoltage 1 Block	0 to 65535	---	1	F300	0
7F67	Auxiliary Undervoltage 1 Target	0 to 2	---	1	F109	0 (Self-reset)
7F68	Auxiliary Undervoltage 1 Events	0 to 1	---	1	F102	0 (Disabled)
7F69	Reserved (7 items)	0 to 65535	---	1	F001	0
7F70	...Repeated for Auxiliary Undervoltage 2					
7F80	...Repeated for Auxiliary Undervoltage 3					
Frequency (Read Only)						
8000	Tracking Frequency	2 to 90	Hz	0.01	F001	0
EGD Fast Production Status (Read Only)						
83E0	EGD Fast Producer Exchange 1 Signature	0 to 65535	---	1	F001	0
83E1	EGD Fast Producer Exchange 1 Configuration Time	0 to 4294967295	---	---	F003	0
83E3	EGD Fast Producer Exchange 1 Size	0 to 65535	---	1	F001	0

B

Table B-9: MODBUS MEMORY MAP (Sheet 24 of 43)

ADDR	REGISTER NAME	RANGE	UNITS	STEP	FORMAT	DEFAULT
EGD Slow Production Status (Read Only) (2 modules)						
83F0	EGD Slow Producer Exchange 1 Signature	0 to 65535	---	1	F001	0
83F1	EGD Slow Producer Exchange 1 Configuration Time	0 to 4294967295	---	---	F003	0
83F3	EGD Slow Producer Exchange 1 Size	0 to 65535	---	1	F001	0
83F4	...Repeated for module number 2					
EGD Fast Production (Read/Write Setting)						
8400	EGD Fast Producer Exchange 1 Function	0 to 1	---	1	F102	0 (Disabled)
8401	EGD Fast Producer Exchange 1 Destination	0 to 4294967295	---	1	F003	0
8403	EGD Fast Producer Exchange 1 Data Rate	50 to 1000	ms	50	F001	1000
8404	EGD Fast Producer Exchange 1 Data Item 1 (20 items)	0 to 65535	---	1	F001	0
8418	Reserved (80 items)	---	---	---	F001	0
EGD Slow Production (Read/Write Setting) (2 modules)						
8500	EGD Slow Producer Exchange 1 Function	0 to 1	---	1	F102	0 (Disabled)
8501	EGD Fast Producer Exchange 1 Destination	0 to 4294967295	---	1	F003	0
8503	EGD Slow Producer Exchange 1 Data Rate	500 to 1000	ms	50	F001	1000
8504	EGD Slow Producer Exchange 1 Data Item 1 (50 items)	0 to 65535	---	1	F001	0
8536	Reserved (50 items)	---	---	---	F001	0
8568	...Repeated for EGD Exchange 2					
FlexState Settings (Read/Write Setting)						
8800	FlexState Parameters (256 items)	---	---	---	F300	0
Digital Elements (Read/Write Setting) (48 modules)						
8A00	Digital Element 1 Function	0 to 1	---	1	F102	0 (Disabled)
8A01	Digital Element 1 Name	---	---	---	F203	"Dig Element 1"
8A09	Digital Element 1 Input	0 to 65535	---	1	F300	0
8A0A	Digital Element 1 Pickup Delay	0 to 999999.999	s	0.001	F003	0
8A0C	Digital Element 1 Reset Delay	0 to 999999.999	s	0.001	F003	0
8A0E	Digital Element 1 Block	0 to 65535	---	1	F300	0
8A0F	Digital Element 1 Target	0 to 2	---	1	F109	0 (Self-reset)
8A10	Digital Element 1 Events	0 to 1	---	1	F102	0 (Disabled)
8A11	Digital Element 1 Pickup LED	0 to 1	---	1	F102	1 (Enabled)
8A12	Reserved (2 items)	---	---	---	F001	0
8A14	...Repeated for Digital Element 2					
8A28	...Repeated for Digital Element 3					
8A3C	...Repeated for Digital Element 4					
8A50	...Repeated for Digital Element 5					
8A64	...Repeated for Digital Element 6					
8A78	...Repeated for Digital Element 7					
8A8C	...Repeated for Digital Element 8					
8AA0	...Repeated for Digital Element 9					
8AB4	...Repeated for Digital Element 10					
8AC8	...Repeated for Digital Element 11					
8ADC	...Repeated for Digital Element 12					
8AF0	...Repeated for Digital Element 13					
8B04	...Repeated for Digital Element 14					
8B18	...Repeated for Digital Element 15					
8B2C	...Repeated for Digital Element 16					
8B40	...Repeated for Digital Element 17					
8B54	...Repeated for Digital Element 18					
8B68	...Repeated for Digital Element 19					
8B7C	...Repeated for Digital Element 20					
8B90	...Repeated for Digital Element 21					
8BA4	...Repeated for Digital Element 22					
8BB8	...Repeated for Digital Element 23					
8BCC	...Repeated for Digital Element 24					

B

Table B-9: MODBUS MEMORY MAP (Sheet 25 of 43)

ADDR	REGISTER NAME	RANGE	UNITS	STEP	FORMAT	DEFAULT
8BE0	...Repeated for Digital Element 25					
8BF4	...Repeated for Digital Element 26					
8C08	...Repeated for Digital Element 27					
8C1C	...Repeated for Digital Element 28					
8C30	...Repeated for Digital Element 29					
8C44	...Repeated for Digital Element 30					
8C58	...Repeated for Digital Element 31					
8C6C	...Repeated for Digital Element 32					
8C80	...Repeated for Digital Element 33					
8C94	...Repeated for Digital Element 34					
8CA8	...Repeated for Digital Element 35					
8CBC	...Repeated for Digital Element 36					
8CD0	...Repeated for Digital Element 37					
8CE4	...Repeated for Digital Element 38					
8CF8	...Repeated for Digital Element 39					
8D0C	...Repeated for Digital Element 40					
8D20	...Repeated for Digital Element 41					
8D34	...Repeated for Digital Element 42					
8D48	...Repeated for Digital Element 43					
8D5C	...Repeated for Digital Element 44					
8D70	...Repeated for Digital Element 45					
8D84	...Repeated for Digital Element 46					
8D98	...Repeated for Digital Element 47					
8DAC	...Repeated for Digital Element 48					
FlexElement (Read/Write Setting) (16 modules)						
9000	FlexElement™ 1 Function	0 to 1	---	1	F102	0 (Disabled)
9001	FlexElement™ 1 Name	---	---	---	F206	"FxE 1"
9004	FlexElement™ 1 InputP	0 to 65535	---	1	F600	0
9005	FlexElement™ 1 InputM	0 to 65535	---	1	F600	0
9006	FlexElement™ 1 Compare	0 to 1	---	1	F516	0 (LEVEL)
9007	FlexElement™ 1 Input	0 to 1	---	1	F515	0 (SIGNED)
9008	FlexElement™ 1 Direction	0 to 1	---	1	F517	0 (OVER)
9009	FlexElement™ 1 Hysteresis	0.1 to 50	%	0.1	F001	30
900A	FlexElement™ 1 Pickup	-90 to 90	pu	0.001	F004	1000
900C	FlexElement™ 1 DeltaT Units	0 to 2	---	1	F518	0 (Milliseconds)
900D	FlexElement™ 1 DeltaT	20 to 86400	---	1	F003	20
900F	FlexElement™ 1 Pickup Delay	0 to 65.535	s	0.001	F001	0
9010	FlexElement™ 1 Reset Delay	0 to 65.535	s	0.001	F001	0
9011	FlexElement™ 1 Block	0 to 65535	---	1	F300	0
9012	FlexElement™ 1 Target	0 to 2	---	1	F109	0 (Self-reset)
9013	FlexElement™ 1 Events	0 to 1	---	1	F102	0 (Disabled)
9014	...Repeated for FlexElement™ 2					
9028	...Repeated for FlexElement™ 3					
903C	...Repeated for FlexElement™ 4					
9050	...Repeated for FlexElement™ 5					
9064	...Repeated for FlexElement™ 6					
9078	...Repeated for FlexElement™ 7					
908C	...Repeated for FlexElement™ 8					
90A0	...Repeated for FlexElement™ 9					
90B4	...Repeated for FlexElement™ 10					
90C8	...Repeated for FlexElement™ 11					
90DC	...Repeated for FlexElement™ 12					
90F0	...Repeated for FlexElement™ 13					
9104	...Repeated for FlexElement™ 14					

B

Table B-9: MODBUS MEMORY MAP (Sheet 26 of 43)

ADDR	REGISTER NAME	RANGE	UNITS	STEP	FORMAT	DEFAULT
9118	...Repeated for FlexElement™ 15					
912C	...Repeated for FlexElement™ 16					
DCMA Outputs (Read/Write Setting) (24 modules)						
9300	dcmA Output 1 Source	0 to 65535	---	1	F600	0
9301	dcmA Output 1 Range	0 to 2	---	1	F522	0 (-1 to 1 mA)
9302	dcmA Output 1 Minimum	-90 to 90	pu	0.001	F004	0
9304	dcmA Output 1 Maximum	-90 to 90	pu	0.001	F004	1000
9306	...Repeated for dcmA Output 2					
930C	...Repeated for dcmA Output 3					
9312	...Repeated for dcmA Output 4					
9318	...Repeated for dcmA Output 5					
931E	...Repeated for dcmA Output 6					
9324	...Repeated for dcmA Output 7					
932A	...Repeated for dcmA Output 8					
9330	...Repeated for dcmA Output 9					
9336	...Repeated for dcmA Output 10					
933C	...Repeated for dcmA Output 11					
9342	...Repeated for dcmA Output 12					
9348	...Repeated for dcmA Output 13					
934E	...Repeated for dcmA Output 14					
9354	...Repeated for dcmA Output 15					
935A	...Repeated for dcmA Output 16					
9360	...Repeated for dcmA Output 17					
9366	...Repeated for dcmA Output 18					
936C	...Repeated for dcmA Output 19					
9372	...Repeated for dcmA Output 20					
9378	...Repeated for dcmA Output 21					
937E	...Repeated for dcmA Output 22					
9384	...Repeated for dcmA Output 23					
938A	...Repeated for dcmA Output 24					
Direct Input/Output Names (Read/Write Setting) (96 modules)						
9400	Direct Input 1 Name	0 to 96	---	1	F205	"Dir Ip 1"
9406	Direct Output 1 Name	1 to 96	---	1	F205	"Dir Out 1"
940C	...Repeated for Direct Input/Output 2					
9418	...Repeated for Direct Input/Output 3					
9424	...Repeated for Direct Input/Output 4					
9430	...Repeated for Direct Input/Output 5					
943C	...Repeated for Direct Input/Output 6					
9448	...Repeated for Direct Input/Output 7					
9454	...Repeated for Direct Input/Output 8					
9460	...Repeated for Direct Input/Output 9					
946C	...Repeated for Direct Input/Output 10					
9478	...Repeated for Direct Input/Output 11					
9484	...Repeated for Direct Input/Output 12					
9490	...Repeated for Direct Input/Output 13					
949C	...Repeated for Direct Input/Output 14					
94A8	...Repeated for Direct Input/Output 15					
94B4	...Repeated for Direct Input/Output 16					
94C0	...Repeated for Direct Input/Output 17					
94CC	...Repeated for Direct Input/Output 18					
94D8	...Repeated for Direct Input/Output 19					
94E4	...Repeated for Direct Input/Output 20					
94F0	...Repeated for Direct Input/Output 21					
94FC	...Repeated for Direct Input/Output 22					

B

Table B-9: MODBUS MEMORY MAP (Sheet 27 of 43)

ADDR	REGISTER NAME	RANGE	UNITS	STEP	FORMAT	DEFAULT
9508	...Repeated for Direct Input/Output 23					
9514	...Repeated for Direct Input/Output 24					
9520	...Repeated for Direct Input/Output 25					
952C	...Repeated for Direct Input/Output 26					
9538	...Repeated for Direct Input/Output 27					
9544	...Repeated for Direct Input/Output 28					
9550	...Repeated for Direct Input/Output 29					
955C	...Repeated for Direct Input/Output 30					
9568	...Repeated for Direct Input/Output 31					
9574	...Repeated for Direct Input/Output 32					
FlexElement Actuals (Read Only) (16 modules)						
9A01	FlexElement™ 1 Actual	-2147483.647 to 2147483.647	---	0.001	F004	0
9A03	FlexElement™ 2 Actual	-2147483.647 to 2147483.647	---	0.001	F004	0
9A05	FlexElement™ 3 Actual	-2147483.647 to 2147483.647	---	0.001	F004	0
9A07	FlexElement™ 4 Actual	-2147483.647 to 2147483.647	---	0.001	F004	0
9A09	FlexElement™ 5 Actual	-2147483.647 to 2147483.647	---	0.001	F004	0
9A0B	FlexElement™ 6 Actual	-2147483.647 to 2147483.647	---	0.001	F004	0
9A0D	FlexElement™ 7 Actual	-2147483.647 to 2147483.647	---	0.001	F004	0
9A0F	FlexElement™ 8 Actual	-2147483.647 to 2147483.647	---	0.001	F004	0
9A11	FlexElement™ 9 Actual	-2147483.647 to 2147483.647	---	0.001	F004	0
9A13	FlexElement™ 10 Actual	-2147483.647 to 2147483.647	---	0.001	F004	0
9A15	FlexElement™ 11 Actual	-2147483.647 to 2147483.647	---	0.001	F004	0
9A17	FlexElement™ 12 Actual	-2147483.647 to 2147483.647	---	0.001	F004	0
9A19	FlexElement™ 13 Actual	-2147483.647 to 2147483.647	---	0.001	F004	0
9A1B	FlexElement™ 14 Actual	-2147483.647 to 2147483.647	---	0.001	F004	0
9A1D	FlexElement™ 15 Actual	-2147483.647 to 2147483.647	---	0.001	F004	0
9A1F	FlexElement™ 16 Actual	-2147483.647 to 2147483.647	---	0.001	F004	0
Teleprotection Inputs/Outputs (Read/Write Settings)						
9B00	Teleprotection Function	0 to 1	---	1	F102	0 (Disabled)
9B01	Teleprotection Number of Terminals	2 to 3	---	1	F001	2
9B02	Teleprotection Number of Channels	1 to 2	---	1	F001	1
9B03	Teleprotection Local Relay ID	0 to 255	---	1	F001	0
9B04	Teleprotection Terminal 1 ID	0 to 255	---	1	F001	0
9B05	Teleprotection Terminal 2 ID	0 to 255	---	1	F001	0
9B06	Reserved (10 items)	0 to 1	---	---	F001	0
9B10	Teleprotection Input 1-n Default States (16 items)	0 to 3	---	1	F086	0 (Off)
9B30	Teleprotection Input 2-n Default States (16 items)	0 to 3	---	1	F086	0 (Off)
9B50	Teleprotection Output 1-n Operand (16 items)	0 to 65535	---	1	F300	0
9B70	Teleprotection Output 2-n Operand (16 items)	0 to 65535	---	1	F300	0
Teleprotection Inputs/Outputs Commands (Read/Write Command)						
9B90	Teleprotection Clear Lost Packets	0 to 1	---	1	F126	0 (No)
Teleprotection Channel Tests (Read Only)						
9B91	Teleprotection Channel 1 Status	0 to 2	---	1	F134	1 (OK)
9B92	Teleprotection Channel 1 Number of Lost Packets	0 to 65535	---	1	F001	0
9B93	Teleprotection Channel 2 Status	0 to 2	---	1	F134	1 (OK)
9B94	Teleprotection Channel 2 Number of Lost Packets	0 to 65535	---	1	F001	0
9B95	Teleprotection Network Status	0 to 2	---	1	F134	2 (n/a)
9BA0	Teleprotection Channel 1 Input States	0 to 1	---	1	F500	0
9BA1	Teleprotection Channel 2 Input States	0 to 1	---	1	F500	0
9BB0	Teleprotection Input 1 States, 1 per register (16 items)	0 to 1	---	1	F108	0 (Off)
9BC0	Teleprotection Input 2 States, 1 per register (16 items)	0 to 1	---	1	F108	0 (Off)
Selector Switch Actuals (Read Only)						
A400	Selector 1 Position	1 to 7	---	1	F001	0
A401	Selector 2 Position	1 to 7	---	1	F001	1

Table B-9: MODBUS MEMORY MAP (Sheet 28 of 43)

ADDR	REGISTER NAME	RANGE	UNITS	STEP	FORMAT	DEFAULT
Selector Switch (Read/Write Setting) (2 modules)						
A410	Selector 1 Function	0 to 1	---	1	F102	0 (Disabled)
A411	Selector 1 Range	1 to 7	---	1	F001	7
A412	Selector 1 Timeout	3 to 60	s	0.1	F001	50
A413	Selector 1 Step Up	0 to 65535	---	1	F300	0
A414	Selector 1 Step Mode	0 to 1	---	1	F083	0 (Time-out)
A415	Selector 1 Acknowledge	0 to 65535	---	1	F300	0
A416	Selector 1 Bit0	0 to 65535	---	1	F300	0
A417	Selector 1 Bit1	0 to 65535	---	1	F300	0
A418	Selector 1 Bit2	0 to 65535	---	1	F300	0
A419	Selector 1 Bit Mode	0 to 1	---	1	F083	0 (Time-out)
A41A	Selector 1 Bit Acknowledge	0 to 65535	---	1	F300	0
A41B	Selector 1 Power Up Mode	0 to 2	---	1	F084	0 (Restore)
A41C	Selector 1 Target	0 to 2	---	1	F109	0 (Self-reset)
A41D	Selector 1 Events	0 to 1	---	1	F102	0 (Disabled)
A41E	Reserved (10 items)	---	---	1	F001	0
A428	...Repeated for Selector 2					
DNP/IEC Points (Read/Write Setting)						
A500	DNP/IEC 60870-5-104 Binary Input Points (256 items)	0 to 65535	---	1	F300	0
A600	DNP/IEC 60870-5-104 Analog Input Points (256 items)	0 to 65535	---	1	F300	0
Volts Per Hertz (Read/Write Grouped Setting) (2 modules)						
AB00	Volts Per Hertz 1 Function	0 to 1	---	1	F102	0 (Disabled)
AB01	Volts Per Hertz 1 Source	0 to 5	---	1	F167	0 (SRC 1)
AB02	Volts Per Hertz 1 Pickup	0.8 to 4	pu	0.01	F001	80
AB03	Volts Per Hertz 1 Curves	0 to 7	---	1	F240	0 (Definite Time)
AB04	Volts Per Hertz 1 TD Multiplier	0.05 to 600	---	0.01	F001	100
AB05	Volts Per Hertz 1 Block	0 to 65535	---	1	F300	0
AB08	Volts Per Hertz 1 Events	0 to 1	---	1	F102	0 (Disabled)
AB09	Volts Per Hertz 1 Target	0 to 2	---	1	F109	0 (Self-reset)
AB0A	Volts Per Hertz 1 T Reset	0 to 1000	s	0.1	F001	10
AB0B	...Repeated for Volts Per Hertz 2					
Volts Per Hertz Actuals (Read Only) (2 modules)						
AB20	Volts Per Hertz 1	0 to 65.535	pu	0.001	F001	0
AB21	Volts Per Hertz 2	0 to 65.535	pu	0.001	F001	0
Flexcurves C and D (Read/Write Setting)						
AC00	FlexCurve C (120 items)	0 to 65535	ms	1	F011	0
AC78	FlexCurve D (120 items)	0 to 65535	ms	1	F011	0
Non Volatile Latches (Read/Write Setting) (16 modules)						
AD00	Non-Volatile Latch 1 Function	0 to 1	---	1	F102	0 (Disabled)
AD01	Non-Volatile Latch 1 Type	0 to 1	---	1	F519	0 (Reset Dominant)
AD02	Non-Volatile Latch 1 Set	0 to 65535	---	1	F300	0
AD03	Non-Volatile Latch 1 Reset	0 to 65535	---	1	F300	0
AD04	Non-Volatile Latch 1 Target	0 to 2	---	1	F109	0 (Self-reset)
AD05	Non-Volatile Latch 1 Events	0 to 1	---	1	F102	0 (Disabled)
AD06	Reserved (4 items)	---	---	---	F001	0
AD0A	...Repeated for Non-Volatile Latch 2					
AD14	...Repeated for Non-Volatile Latch 3					
AD1E	...Repeated for Non-Volatile Latch 4					
AD28	...Repeated for Non-Volatile Latch 5					
AD32	...Repeated for Non-Volatile Latch 6					
AD3C	...Repeated for Non-Volatile Latch 7					
AD46	...Repeated for Non-Volatile Latch 8					
AD50	...Repeated for Non-Volatile Latch 9					
AD5A	...Repeated for Non-Volatile Latch 10					

Table B-9: MODBUS MEMORY MAP (Sheet 29 of 43)

ADDR	REGISTER NAME	RANGE	UNITS	STEP	FORMAT	DEFAULT
AD64	...Repeated for Non-Volatile Latch 11					
AD6E	...Repeated for Non-Volatile Latch 12					
AD78	...Repeated for Non-Volatile Latch 13					
AD82	...Repeated for Non-Volatile Latch 14					
AD8C	...Repeated for Non-Volatile Latch 15					
AD96	...Repeated for Non-Volatile Latch 16					
Digital Counter (Read/Write Setting) (8 modules)						
B300	Digital Counter 1 Function	0 to 1	---	1	F102	0 (Disabled)
B301	Digital Counter 1 Name	---	---	---	F205	"Counter 1"
B307	Digital Counter 1 Units	---	---	---	F206	(none)
B30A	Digital Counter 1 Block	0 to 65535	---	1	F300	0
B30B	Digital Counter 1 Up	0 to 65535	---	1	F300	0
B30C	Digital Counter 1 Down	0 to 65535	---	1	F300	0
B30D	Digital Counter 1 Preset	-2147483647 to 2147483647	---	1	F004	0
B30F	Digital Counter 1 Compare	-2147483647 to 2147483647	---	1	F004	0
B311	Digital Counter 1 Reset	0 to 65535	---	1	F300	0
B312	Digital Counter 1 Freeze/Reset	0 to 65535	---	1	F300	0
B313	Digital Counter 1 Freeze/Count	0 to 65535	---	1	F300	0
B314	Digital Counter 1 Set To Preset	0 to 65535	---	1	F300	0
B315	Reserved (11 items)	---	---	---	F001	0
B320	...Repeated for Digital Counter 2					
B340	...Repeated for Digital Counter 3					
B360	...Repeated for Digital Counter 4					
B380	...Repeated for Digital Counter 5					
B3A0	...Repeated for Digital Counter 6					
B3C0	...Repeated for Digital Counter 7					
B3E0	...Repeated for Digital Counter 8					
IEC 61850 GSSE Configuration (Read/Write Setting)						
B680	Default GSSE Update Time	1 to 60	s	1	F001	60
B681	Remote Input/Output Transfer Method	0 to 2	---	1	F226	1 (GSSE)
B682	IEC 61850 GOOSE VLAN Transmit Priority	0 to 7	---	1	F001	4
B683	IEC 61850 GOOSE VLAN ID	0 to 4095	---	1	F001	0
B684	IEC 61850 GOOSE ETYPE APPID	0 to 16383	---	1	F001	0
B685	Reserved (22 items)	0 to 1	---	1	F001	0
IEC 61850 Server Configuration (Read/Write Settings/Commands)						
B6A0	TCP Port Number for the IEC 61850 Protocol	1 to 65535	---	1	F001	102
B6A1	IEC 61850 Logical Device Name	---	---	---	F213	"IECDevice"
B6B1	Include Non-IEC 61850 Data	0 to 1	---	1	F102	1 (Enabled)
B6B2	Number of Status Indications in GGIO1	8 to 128	---	8	F001	8
B6B3	IEC 61850 Server Data Scanning Function	0 to 1	---	1	F102	0 (Disabled)
B6B4	Command to Clear XCBR1 OpCnt Counter	0 to 1	---	1	F126	0 (No)
B6B5	Command to Clear XCBR2 OpCnt Counter	0 to 1	---	1	F126	0 (No)
B6B6	Reserved (10 items)	0 to 1	---	1	F001	0
IEC 61850 Logical Node Name Prefixes (Read/Write Setting)						
B700	IEC 61850 Logical Node PIOCx Name Prefix (72 items)	0 to 65534	---	1	F206	(None)
B7D8	IEC 61850 Logical Node PTOCx Name Prefix (24 items)	0 to 65534	---	1	F206	(None)
B820	IEC 61850 Logical Node PTUVx Name Prefix (12 items)	0 to 65534	---	1	F206	(None)
B844	IEC 61850 Logical Node PTOVx Name Prefix (8 items)	0 to 65534	---	1	F206	(None)
B85C	IEC 61850 Logical Node PDISx Name Prefix (10 items)	0 to 65534	---	1	F206	(None)
B87A	IEC 61850 Logical Node RRBfx Name Prefix (24 items)	0 to 65534	---	1	F206	(None)
B8C2	IEC 61850 Logical Node RPSBx Name Prefix	0 to 65534	---	1	F206	(None)
B8C5	IEC 61850 Logical Node RREcx Name Prefix (6 items)	0 to 65534	---	1	F206	(None)
B8D7	IEC 61850 Logical Node MMXUx Name Prefix (6 items)	0 to 65534	---	1	F206	(None)
B8E9	IEC 61850 Logical Node GGIOx Name Prefix (2 items)	0 to 65534	---	1	F206	(None)

Table B-9: MODBUS MEMORY MAP (Sheet 30 of 43)

ADDR	REGISTER NAME	RANGE	UNITS	STEP	FORMAT	DEFAULT
B8EF	IEC 61850 Logical Node RFLOx Name Prefix (5 items)	0 to 65534	---	1	F206	(None)
B8FE	IEC 61850 Logical Node XCBRx Name Prefix (2 items)	0 to 65534	---	1	F206	(None)
B904	IEC 61850 Logical Node PTRCx Name Prefix (2 items)	0 to 65534	---	1	F206	(None)
B90A	IEC 61850 Logical Node PDIFx Name Prefix (4 items)	0 to 65534	---	1	F206	(None)
B916	IEC 61850 Logical Node MMXNx Name Prefix (37 items)	0 to 65534	---	1	F206	(None)
IEC 61850 MMXU Deadbands (Read/Write Setting) (6 modules)						
BA00	IEC 61850 MMXU TotW Deadband 1	0.001 to 100	%	0.001	F003	10000
BA02	IEC 61850 MMXU TotVAr Deadband 1	0.001 to 100	%	0.001	F003	10000
BA04	IEC 61850 MMXU TotVA Deadband 1	0.001 to 100	%	0.001	F003	10000
BA06	IEC 61850 MMXU TotPF Deadband 1	0.001 to 100	%	0.001	F003	10000
BA08	IEC 61850 MMXU Hz Deadband 1	0.001 to 100	%	0.001	F003	10000
BA0A	IEC 61850 MMXU PPV.phsAB Deadband 1	0.001 to 100	%	0.001	F003	10000
BA0C	IEC 61850 MMXU PPV.phsBC Deadband 1	0.001 to 100	%	0.001	F003	10000
BA0E	IEC 61850 MMXU PPV.phsCA Deadband 1	0.001 to 100	%	0.001	F003	10000
BA10	IEC 61850 MMXU PhV.phsADeandband 1	0.001 to 100	%	0.001	F003	10000
BA12	IEC 61850 MMXU PhV.phsB Deadband 1	0.001 to 100	%	0.001	F003	10000
BA14	IEC 61850 MMXU PhV.phsC Deadband 1	0.001 to 100	%	0.001	F003	10000
BA16	IEC 61850 MMXU A.phsA Deadband 1	0.001 to 100	%	0.001	F003	10000
BA18	IEC 61850 MMXU A.phsB Deadband 1	0.001 to 100	%	0.001	F003	10000
BA1A	IEC 61850 MMXU A.phsC Deadband 1	0.001 to 100	%	0.001	F003	10000
BA1C	IEC 61850 MMXU A.neut Deadband 1	0.001 to 100	%	0.001	F003	10000
BA1E	IEC 61850 MMXU W.phsA Deadband 1	0.001 to 100	%	0.001	F003	10000
BA20	IEC 61850 MMXU W.phsB Deadband 1	0.001 to 100	%	0.001	F003	10000
BA22	IEC 61850 MMXU W.phsC Deadband 1	0.001 to 100	%	0.001	F003	10000
BA24	IEC 61850 MMXU VAr.phsA Deadband 1	0.001 to 100	%	0.001	F003	10000
BA26	IEC 61850 MMXU VAr.phsB Deadband 1	0.001 to 100	%	0.001	F003	10000
BA28	IEC 61850 MMXU VAr.phsC Deadband 1	0.001 to 100	%	0.001	F003	10000
BA2A	IEC 61850 MMXU VA.phsA Deadband 1	0.001 to 100	%	0.001	F003	10000
BA2C	IEC 61850 MMXU VA.phsB Deadband 1	0.001 to 100	%	0.001	F003	10000
BA2E	IEC 61850 MMXU VA.phsC Deadband 1	0.001 to 100	%	0.001	F003	10000
BA30	IEC 61850 MMXU PF.phsA Deadband 1	0.001 to 100	%	0.001	F003	10000
BA32	IEC 61850 MMXU PF.phsB Deadband 1	0.001 to 100	%	0.001	F003	10000
BA34	IEC 61850 MMXU PF.phsC Deadband 1	0.001 to 100	%	0.001	F003	10000
BA36	...Repeated for Deadband 2					
BA6C	...Repeated for Deadband 3					
BAA2	...Repeated for Deadband 4					
BAD8	...Repeated for Deadband 5					
BB0E	...Repeated for Deadband 6					
IEC 61850 GGIO2 Control Configuration (Read/Write Setting) (64 modules)						
BC00	IEC 61850 GGIO2.CF.SPSCO1.ctlModel Value	0 to 2	---	1	F001	2
BC01	IEC 61850 GGIO2.CF.SPSCO2.ctlModel Value	0 to 2	---	1	F001	2
BC02	IEC 61850 GGIO2.CF.SPSCO3.ctlModel Value	0 to 2	---	1	F001	2
BC03	IEC 61850 GGIO2.CF.SPSCO4.ctlModel Value	0 to 2	---	1	F001	2
BC04	IEC 61850 GGIO2.CF.SPSCO5.ctlModel Value	0 to 2	---	1	F001	2
BC05	IEC 61850 GGIO2.CF.SPSCO6.ctlModel Value	0 to 2	---	1	F001	2
BC06	IEC 61850 GGIO2.CF.SPSCO7.ctlModel Value	0 to 2	---	1	F001	2
BC07	IEC 61850 GGIO2.CF.SPSCO8.ctlModel Value	0 to 2	---	1	F001	2
BC08	IEC 61850 GGIO2.CF.SPSCO9.ctlModel Value	0 to 2	---	1	F001	2
BC09	IEC 61850 GGIO2.CF.SPSCO10.ctlModel Value	0 to 2	---	1	F001	2
BC0A	IEC 61850 GGIO2.CF.SPSCO11.ctlModel Value	0 to 2	---	1	F001	2
BC0B	IEC 61850 GGIO2.CF.SPSCO12.ctlModel Value	0 to 2	---	1	F001	2
BC0C	IEC 61850 GGIO2.CF.SPSCO13.ctlModel Value	0 to 2	---	1	F001	2
BC0D	IEC 61850 GGIO2.CF.SPSCO14.ctlModel Value	0 to 2	---	1	F001	2
BC0E	IEC 61850 GGIO2.CF.SPSCO15.ctlModel Value	0 to 2	---	1	F001	2

Table B-9: MODBUS MEMORY MAP (Sheet 31 of 43)

ADDR	REGISTER NAME	RANGE	UNITS	STEP	FORMAT	DEFAULT
BC0F	IEC 61850 GGIO2.CF.SPCSO16.ctfModel Value	0 to 2	---	1	F001	2
BC10	IEC 61850 GGIO2.CF.SPCSO17.ctfModel Value	0 to 2	---	1	F001	2
BC11	IEC 61850 GGIO2.CF.SPCSO18.ctfModel Value	0 to 2	---	1	F001	2
BC12	IEC 61850 GGIO2.CF.SPCSO19.ctfModel Value	0 to 2	---	1	F001	2
BC13	IEC 61850 GGIO2.CF.SPCSO20.ctfModel Value	0 to 2	---	1	F001	2
BC14	IEC 61850 GGIO2.CF.SPCSO21.ctfModel Value	0 to 2	---	1	F001	2
BC15	IEC 61850 GGIO2.CF.SPCSO22.ctfModel Value	0 to 2	---	1	F001	2
BC16	IEC 61850 GGIO2.CF.SPCSO23.ctfModel Value	0 to 2	---	1	F001	2
BC17	IEC 61850 GGIO2.CF.SPCSO24.ctfModel Value	0 to 2	---	1	F001	2
BC18	IEC 61850 GGIO2.CF.SPCSO25.ctfModel Value	0 to 2	---	1	F001	2
BC19	IEC 61850 GGIO2.CF.SPCSO26.ctfModel Value	0 to 2	---	1	F001	2
BC1A	IEC 61850 GGIO2.CF.SPCSO27.ctfModel Value	0 to 2	---	1	F001	2
BC1B	IEC 61850 GGIO2.CF.SPCSO28.ctfModel Value	0 to 2	---	1	F001	2
BC1C	IEC 61850 GGIO2.CF.SPCSO29.ctfModel Value	0 to 2	---	1	F001	2
BC1D	IEC 61850 GGIO2.CF.SPCSO30.ctfModel Value	0 to 2	---	1	F001	2
BC1E	IEC 61850 GGIO2.CF.SPCSO31.ctfModel Value	0 to 2	---	1	F001	2
BC1F	IEC 61850 GGIO2.CF.SPCSO32.ctfModel Value	0 to 2	---	1	F001	2
BC20	IEC 61850 GGIO2.CF.SPCSO33.ctfModel Value	0 to 2	---	1	F001	2
BC21	IEC 61850 GGIO2.CF.SPCSO34.ctfModel Value	0 to 2	---	1	F001	2
BC22	IEC 61850 GGIO2.CF.SPCSO35.ctfModel Value	0 to 2	---	1	F001	2
BC23	IEC 61850 GGIO2.CF.SPCSO36.ctfModel Value	0 to 2	---	1	F001	2
BC24	IEC 61850 GGIO2.CF.SPCSO37.ctfModel Value	0 to 2	---	1	F001	2
BC25	IEC 61850 GGIO2.CF.SPCSO38.ctfModel Value	0 to 2	---	1	F001	2
BC26	IEC 61850 GGIO2.CF.SPCSO39.ctfModel Value	0 to 2	---	1	F001	2
BC27	IEC 61850 GGIO2.CF.SPCSO40.ctfModel Value	0 to 2	---	1	F001	2
BC28	IEC 61850 GGIO2.CF.SPCSO41.ctfModel Value	0 to 2	---	1	F001	2
BC29	IEC 61850 GGIO2.CF.SPCSO42.ctfModel Value	0 to 2	---	1	F001	2
BC2A	IEC 61850 GGIO2.CF.SPCSO43.ctfModel Value	0 to 2	---	1	F001	2
BC2B	IEC 61850 GGIO2.CF.SPCSO44.ctfModel Value	0 to 2	---	1	F001	2
BC2C	IEC 61850 GGIO2.CF.SPCSO45.ctfModel Value	0 to 2	---	1	F001	2
BC2D	IEC 61850 GGIO2.CF.SPCSO46.ctfModel Value	0 to 2	---	1	F001	2
BC2E	IEC 61850 GGIO2.CF.SPCSO47.ctfModel Value	0 to 2	---	1	F001	2
BC2F	IEC 61850 GGIO2.CF.SPCSO48.ctfModel Value	0 to 2	---	1	F001	2
BC30	IEC 61850 GGIO2.CF.SPCSO49.ctfModel Value	0 to 2	---	1	F001	2
BC31	IEC 61850 GGIO2.CF.SPCSO50.ctfModel Value	0 to 2	---	1	F001	2
BC32	IEC 61850 GGIO2.CF.SPCSO51.ctfModel Value	0 to 2	---	1	F001	2
BC33	IEC 61850 GGIO2.CF.SPCSO52.ctfModel Value	0 to 2	---	1	F001	2
BC34	IEC 61850 GGIO2.CF.SPCSO53.ctfModel Value	0 to 2	---	1	F001	2
BC35	IEC 61850 GGIO2.CF.SPCSO54.ctfModel Value	0 to 2	---	1	F001	2
BC36	IEC 61850 GGIO2.CF.SPCSO55.ctfModel Value	0 to 2	---	1	F001	2
BC37	IEC 61850 GGIO2.CF.SPCSO56.ctfModel Value	0 to 2	---	1	F001	2
BC38	IEC 61850 GGIO2.CF.SPCSO57.ctfModel Value	0 to 2	---	1	F001	2
BC39	IEC 61850 GGIO2.CF.SPCSO58.ctfModel Value	0 to 2	---	1	F001	2
BC3A	IEC 61850 GGIO2.CF.SPCSO59.ctfModel Value	0 to 2	---	1	F001	2
BC3B	IEC 61850 GGIO2.CF.SPCSO60.ctfModel Value	0 to 2	---	1	F001	2
BC3C	IEC 61850 GGIO2.CF.SPCSO61.ctfModel Value	0 to 2	---	1	F001	2
BC3D	IEC 61850 GGIO2.CF.SPCSO62.ctfModel Value	0 to 2	---	1	F001	2
BC3E	IEC 61850 GGIO2.CF.SPCSO63.ctfModel Value	0 to 2	---	1	F001	2
BC3F	IEC 61850 GGIO2.CF.SPCSO64.ctfModel Value	0 to 2	---	1	F001	2
Contact Inputs (Read/Write Setting) (96 modules)						
C000	Contact Input 1 Name	---	---	---	F205	"Cont Ip 1"
C006	Contact Input 1 Events	0 to 1	---	1	F102	0 (Disabled)
C007	Contact Input 1 Debounce Time	0 to 16	ms	0.5	F001	20
C008	...Repeated for Contact Input 2					

B

Table B-9: MODBUS MEMORY MAP (Sheet 32 of 43)

ADDR	REGISTER NAME	RANGE	UNITS	STEP	FORMAT	DEFAULT
C010	...Repeated for Contact Input 3					
C018	...Repeated for Contact Input 4					
C020	...Repeated for Contact Input 5					
C028	...Repeated for Contact Input 6					
C030	...Repeated for Contact Input 7					
C038	...Repeated for Contact Input 8					
C040	...Repeated for Contact Input 9					
C048	...Repeated for Contact Input 10					
C050	...Repeated for Contact Input 11					
C058	...Repeated for Contact Input 12					
C060	...Repeated for Contact Input 13					
C068	...Repeated for Contact Input 14					
C070	...Repeated for Contact Input 15					
C078	...Repeated for Contact Input 16					
C080	...Repeated for Contact Input 17					
C088	...Repeated for Contact Input 18					
C090	...Repeated for Contact Input 19					
C098	...Repeated for Contact Input 20					
C0A0	...Repeated for Contact Input 21					
C0A8	...Repeated for Contact Input 22					
C0B0	...Repeated for Contact Input 23					
C0B8	...Repeated for Contact Input 24					
C0C0	...Repeated for Contact Input 25					
C0C8	...Repeated for Contact Input 26					
C0D0	...Repeated for Contact Input 27					
C0D8	...Repeated for Contact Input 28					
C0E0	...Repeated for Contact Input 29					
C0E8	...Repeated for Contact Input 30					
C0F0	...Repeated for Contact Input 31					
C0F8	...Repeated for Contact Input 32					
C100	...Repeated for Contact Input 33					
C108	...Repeated for Contact Input 34					
C110	...Repeated for Contact Input 35					
C118	...Repeated for Contact Input 36					
C120	...Repeated for Contact Input 37					
C128	...Repeated for Contact Input 38					
C130	...Repeated for Contact Input 39					
C138	...Repeated for Contact Input 40					
C140	...Repeated for Contact Input 41					
C148	...Repeated for Contact Input 42					
C150	...Repeated for Contact Input 43					
C158	...Repeated for Contact Input 44					
C160	...Repeated for Contact Input 45					
C168	...Repeated for Contact Input 46					
C170	...Repeated for Contact Input 47					
C178	...Repeated for Contact Input 48					
C180	...Repeated for Contact Input 49					
C188	...Repeated for Contact Input 50					
C190	...Repeated for Contact Input 51					
C198	...Repeated for Contact Input 52					
C1A0	...Repeated for Contact Input 53					
C1A8	...Repeated for Contact Input 54					
C1B0	...Repeated for Contact Input 55					
C1B8	...Repeated for Contact Input 56					

B

Table B-9: MODBUS MEMORY MAP (Sheet 33 of 43)

ADDR	REGISTER NAME	RANGE	UNITS	STEP	FORMAT	DEFAULT
C1C0	...Repeated for Contact Input 57					
C1C8	...Repeated for Contact Input 58					
C1D0	...Repeated for Contact Input 59					
C1D8	...Repeated for Contact Input 60					
C1E0	...Repeated for Contact Input 61					
C1E8	...Repeated for Contact Input 62					
C1F0	...Repeated for Contact Input 63					
C1F8	...Repeated for Contact Input 64					
C200	...Repeated for Contact Input 65					
C208	...Repeated for Contact Input 66					
C210	...Repeated for Contact Input 67					
C218	...Repeated for Contact Input 68					
C220	...Repeated for Contact Input 69					
C228	...Repeated for Contact Input 70					
C230	...Repeated for Contact Input 71					
C238	...Repeated for Contact Input 72					
C240	...Repeated for Contact Input 73					
C248	...Repeated for Contact Input 74					
C250	...Repeated for Contact Input 75					
C258	...Repeated for Contact Input 76					
C260	...Repeated for Contact Input 77					
C268	...Repeated for Contact Input 78					
C270	...Repeated for Contact Input 79					
C278	...Repeated for Contact Input 80					
C280	...Repeated for Contact Input 81					
C288	...Repeated for Contact Input 82					
C290	...Repeated for Contact Input 83					
C298	...Repeated for Contact Input 84					
C2A0	...Repeated for Contact Input 85					
C2A8	...Repeated for Contact Input 86					
C2B0	...Repeated for Contact Input 87					
C2B8	...Repeated for Contact Input 88					
C2C0	...Repeated for Contact Input 89					
C2C8	...Repeated for Contact Input 90					
C2D0	...Repeated for Contact Input 91					
C2D8	...Repeated for Contact Input 92					
C2E0	...Repeated for Contact Input 93					
C2E8	...Repeated for Contact Input 94					
C2F0	...Repeated for Contact Input 95					
C2F8	...Repeated for Contact Input 96					
Contact Input Thresholds (Read/Write Setting)						
C600	Contact Input <i>n</i> Threshold, <i>n</i> = 1 to 24 (24 items)	0 to 3	---	1	F128	1 (33 Vdc)
Virtual Inputs (Read/Write Setting) (64 modules)						
C690	Virtual Input 1 Function	0 to 1	---	1	F102	0 (Disabled)
C691	Virtual Input 1 Name	---	---	---	F205	"Virt Ip 1"
C69B	Virtual Input 1 Programmed Type	0 to 1	---	1	F127	0 (Latched)
C69C	Virtual Input 1 Events	0 to 1	---	1	F102	0 (Disabled)
C69D	Reserved (3 items)	---	---	---	F001	0
C6A0	...Repeated for Virtual Input 2					
C6B0	...Repeated for Virtual Input 3					
C6C0	...Repeated for Virtual Input 4					
C6D0	...Repeated for Virtual Input 5					
C6E0	...Repeated for Virtual Input 6					
C6F0	...Repeated for Virtual Input 7					

B

Table B-9: MODBUS MEMORY MAP (Sheet 34 of 43)

ADDR	REGISTER NAME	RANGE	UNITS	STEP	FORMAT	DEFAULT
C700	...Repeated for Virtual Input 8					
C710	...Repeated for Virtual Input 9					
C720	...Repeated for Virtual Input 10					
C730	...Repeated for Virtual Input 11					
C740	...Repeated for Virtual Input 12					
C750	...Repeated for Virtual Input 13					
C760	...Repeated for Virtual Input 14					
C770	...Repeated for Virtual Input 15					
C780	...Repeated for Virtual Input 16					
C790	...Repeated for Virtual Input 17					
C7A0	...Repeated for Virtual Input 18					
C7B0	...Repeated for Virtual Input 19					
C7C0	...Repeated for Virtual Input 20					
C7D0	...Repeated for Virtual Input 21					
C7E0	...Repeated for Virtual Input 22					
C7F0	...Repeated for Virtual Input 23					
C800	...Repeated for Virtual Input 24					
C810	...Repeated for Virtual Input 25					
C820	...Repeated for Virtual Input 26					
C830	...Repeated for Virtual Input 27					
C840	...Repeated for Virtual Input 28					
C850	...Repeated for Virtual Input 29					
C860	...Repeated for Virtual Input 30					
C870	...Repeated for Virtual Input 31					
C880	...Repeated for Virtual Input 32					
C890	...Repeated for Virtual Input 33					
C8A0	...Repeated for Virtual Input 34					
C8B0	...Repeated for Virtual Input 35					
C8C0	...Repeated for Virtual Input 36					
C8D0	...Repeated for Virtual Input 37					
C8E0	...Repeated for Virtual Input 38					
C8F0	...Repeated for Virtual Input 39					
C900	...Repeated for Virtual Input 40					
C910	...Repeated for Virtual Input 41					
C920	...Repeated for Virtual Input 42					
C930	...Repeated for Virtual Input 43					
C940	...Repeated for Virtual Input 44					
C950	...Repeated for Virtual Input 45					
C960	...Repeated for Virtual Input 46					
C970	...Repeated for Virtual Input 47					
C980	...Repeated for Virtual Input 48					
C990	...Repeated for Virtual Input 49					
C9A0	...Repeated for Virtual Input 50					
C9B0	...Repeated for Virtual Input 51					
C9C0	...Repeated for Virtual Input 52					
C9D0	...Repeated for Virtual Input 53					
C9E0	...Repeated for Virtual Input 54					
C9F0	...Repeated for Virtual Input 55					
CA00	...Repeated for Virtual Input 56					
CA10	...Repeated for Virtual Input 57					
CA20	...Repeated for Virtual Input 58					
CA30	...Repeated for Virtual Input 59					
CA40	...Repeated for Virtual Input 60					
CA50	...Repeated for Virtual Input 61					

B

Table B-9: MODBUS MEMORY MAP (Sheet 35 of 43)

ADDR	REGISTER NAME	RANGE	UNITS	STEP	FORMAT	DEFAULT
CA60	...Repeated for Virtual Input 62					
CA70	...Repeated for Virtual Input 63					
CA80	...Repeated for Virtual Input 64					
Virtual Outputs (Read/Write Setting) (96 modules)						
CC90	Virtual Output 1 Name	---	---	---	F205	"Virt Op 1 "
CC9A	Virtual Output 1 Events	0 to 1	---	1	F102	0 (Disabled)
CC9B	Reserved	---	---	---	F001	0
CC9C	...Repeated for Virtual Output 2					
CCA8	...Repeated for Virtual Output 3					
CCB4	...Repeated for Virtual Output 4					
CCC0	...Repeated for Virtual Output 5					
CCCC	...Repeated for Virtual Output 6					
CCD8	...Repeated for Virtual Output 7					
CCE4	...Repeated for Virtual Output 8					
CCF0	...Repeated for Virtual Output 9					
CCFC	...Repeated for Virtual Output 10					
CD08	...Repeated for Virtual Output 11					
CD14	...Repeated for Virtual Output 12					
CD20	...Repeated for Virtual Output 13					
CD2C	...Repeated for Virtual Output 14					
CD38	...Repeated for Virtual Output 15					
CD44	...Repeated for Virtual Output 16					
CD50	...Repeated for Virtual Output 17					
CD5C	...Repeated for Virtual Output 18					
CD68	...Repeated for Virtual Output 19					
CD74	...Repeated for Virtual Output 20					
CD80	...Repeated for Virtual Output 21					
CD8C	...Repeated for Virtual Output 22					
CD98	...Repeated for Virtual Output 23					
CDA4	...Repeated for Virtual Output 24					
CDB0	...Repeated for Virtual Output 25					
CDBC	...Repeated for Virtual Output 26					
CDC8	...Repeated for Virtual Output 27					
CDD4	...Repeated for Virtual Output 28					
CDE0	...Repeated for Virtual Output 29					
CDEC	...Repeated for Virtual Output 30					
CDF8	...Repeated for Virtual Output 31					
CE04	...Repeated for Virtual Output 32					
CE10	...Repeated for Virtual Output 33					
CE1C	...Repeated for Virtual Output 34					
CE28	...Repeated for Virtual Output 35					
CE34	...Repeated for Virtual Output 36					
CE40	...Repeated for Virtual Output 37					
CE4C	...Repeated for Virtual Output 38					
CE58	...Repeated for Virtual Output 39					
CE64	...Repeated for Virtual Output 40					
CE70	...Repeated for Virtual Output 41					
CE7C	...Repeated for Virtual Output 42					
CE88	...Repeated for Virtual Output 43					
CE94	...Repeated for Virtual Output 44					
CEA0	...Repeated for Virtual Output 45					
CEAC	...Repeated for Virtual Output 46					
CEB8	...Repeated for Virtual Output 47					
CEC4	...Repeated for Virtual Output 48					

B

Table B-9: MODBUS MEMORY MAP (Sheet 36 of 43)

ADDR	REGISTER NAME	RANGE	UNITS	STEP	FORMAT	DEFAULT
CED0	...Repeated for Virtual Output 49					
CEDC	...Repeated for Virtual Output 50					
CEE8	...Repeated for Virtual Output 51					
CEF4	...Repeated for Virtual Output 52					
CF00	...Repeated for Virtual Output 53					
CF0C	...Repeated for Virtual Output 54					
CF18	...Repeated for Virtual Output 55					
CF24	...Repeated for Virtual Output 56					
CF30	...Repeated for Virtual Output 57					
CF3C	...Repeated for Virtual Output 58					
CF48	...Repeated for Virtual Output 59					
CF54	...Repeated for Virtual Output 60					
CF60	...Repeated for Virtual Output 61					
CF6C	...Repeated for Virtual Output 62					
CF78	...Repeated for Virtual Output 63					
CF84	...Repeated for Virtual Output 64					
CF90	...Repeated for Virtual Output 65					
CF9C	...Repeated for Virtual Output 66					
CFA8	...Repeated for Virtual Output 67					
CFB4	...Repeated for Virtual Output 68					
CFC0	...Repeated for Virtual Output 69					
CFCC	...Repeated for Virtual Output 70					
CFD8	...Repeated for Virtual Output 71					
CFE4	...Repeated for Virtual Output 72					
CFF0	...Repeated for Virtual Output 73					
CFFC	...Repeated for Virtual Output 74					
D008	...Repeated for Virtual Output 75					
D014	...Repeated for Virtual Output 76					
D020	...Repeated for Virtual Output 77					
D02C	...Repeated for Virtual Output 78					
D038	...Repeated for Virtual Output 79					
D044	...Repeated for Virtual Output 80					
D050	...Repeated for Virtual Output 81					
D05C	...Repeated for Virtual Output 82					
D068	...Repeated for Virtual Output 83					
D074	...Repeated for Virtual Output 84					
D080	...Repeated for Virtual Output 85					
D08C	...Repeated for Virtual Output 86					
D098	...Repeated for Virtual Output 87					
D0A4	...Repeated for Virtual Output 88					
D0B0	...Repeated for Virtual Output 89					
D0BC	...Repeated for Virtual Output 90					
D0C8	...Repeated for Virtual Output 91					
D0D4	...Repeated for Virtual Output 92					
D0E0	...Repeated for Virtual Output 93					
D0EC	...Repeated for Virtual Output 94					
D0F8	...Repeated for Virtual Output 95					
D104	...Repeated for Virtual Output 96					
Mandatory (Read/Write Setting)						
D280	Test Mode Function	0 to 1	---	1	F102	0 (Disabled)
Mandatory (Read/Write)						
D281	Force VFD and LED	0 to 1	---	1	F126	0 (No)
Mandatory (Read/Write Setting)						
D282	Test Mode Initiate	0 to 65535	---	1	F300	1

B

Table B-9: MODBUS MEMORY MAP (Sheet 37 of 43)

ADDR	REGISTER NAME	RANGE	UNITS	STEP	FORMAT	DEFAULT
Mandatory (Read/Write Command)						
D283	Clear All Relay Records Command	0 to 1	---	1	F126	0 (No)
Contact Outputs (Read/Write Setting) (64 modules)						
D290	Contact Output 1 Name	---	---	---	F205	"Cont Op 1"
D29A	Contact Output 1 Operation	0 to 65535	---	1	F300	0
D29B	Contact Output 1 Seal In	0 to 65535	---	1	F300	0
D29C	Latching Output 1 Reset	0 to 65535	---	1	F300	0
D29D	Contact Output 1 Events	0 to 1	---	1	F102	1 (Enabled)
D29E	Latching Output 1 Type	0 to 1	---	1	F090	0 (Operate-dominant)
D29F	Reserved	---	---	---	F001	0
D2A0	...Repeated for Contact Output 2					
D2B0	...Repeated for Contact Output 3					
D2C0	...Repeated for Contact Output 4					
D2D0	...Repeated for Contact Output 5					
D2E0	...Repeated for Contact Output 6					
D2F0	...Repeated for Contact Output 7					
D300	...Repeated for Contact Output 8					
D310	...Repeated for Contact Output 9					
D320	...Repeated for Contact Output 10					
D330	...Repeated for Contact Output 11					
D340	...Repeated for Contact Output 12					
D350	...Repeated for Contact Output 13					
D360	...Repeated for Contact Output 14					
D370	...Repeated for Contact Output 15					
D380	...Repeated for Contact Output 16					
D390	...Repeated for Contact Output 17					
D3A0	...Repeated for Contact Output 18					
D3B0	...Repeated for Contact Output 19					
D3C0	...Repeated for Contact Output 20					
D3D0	...Repeated for Contact Output 21					
D3E0	...Repeated for Contact Output 22					
D3F0	...Repeated for Contact Output 23					
D400	...Repeated for Contact Output 24					
D410	...Repeated for Contact Output 25					
D420	...Repeated for Contact Output 26					
D430	...Repeated for Contact Output 27					
D440	...Repeated for Contact Output 28					
D450	...Repeated for Contact Output 29					
D460	...Repeated for Contact Output 30					
D470	...Repeated for Contact Output 31					
D480	...Repeated for Contact Output 32					
D490	...Repeated for Contact Output 33					
D4A0	...Repeated for Contact Output 34					
D4B0	...Repeated for Contact Output 35					
D4C0	...Repeated for Contact Output 36					
D4D0	...Repeated for Contact Output 37					
D4E0	...Repeated for Contact Output 38					
D4F0	...Repeated for Contact Output 39					
D500	...Repeated for Contact Output 40					
D510	...Repeated for Contact Output 41					
D520	...Repeated for Contact Output 42					
D530	...Repeated for Contact Output 43					
D540	...Repeated for Contact Output 44					
D550	...Repeated for Contact Output 45					

B

Table B-9: MODBUS MEMORY MAP (Sheet 38 of 43)

ADDR	REGISTER NAME	RANGE	UNITS	STEP	FORMAT	DEFAULT
D560	...Repeated for Contact Output 46					
D570	...Repeated for Contact Output 47					
D580	...Repeated for Contact Output 48					
D590	...Repeated for Contact Output 49					
D5A0	...Repeated for Contact Output 50					
D5B0	...Repeated for Contact Output 51					
D5C0	...Repeated for Contact Output 52					
D5D0	...Repeated for Contact Output 53					
D5E0	...Repeated for Contact Output 54					
D5F0	...Repeated for Contact Output 55					
D600	...Repeated for Contact Output 56					
D610	...Repeated for Contact Output 57					
D620	...Repeated for Contact Output 58					
D630	...Repeated for Contact Output 59					
D640	...Repeated for Contact Output 60					
D650	...Repeated for Contact Output 61					
D660	...Repeated for Contact Output 62					
D670	...Repeated for Contact Output 63					
D680	...Repeated for Contact Output 64					
Reset (Read/Write Setting)						
D800	FlexLogic™ operand which initiates a reset	0 to 65535	---	1	F300	0
Control Pushbuttons (Read/Write Setting) (7 modules)						
D810	Control Pushbutton 1 Function	0 to 1	---	1	F102	0 (Disabled)
D811	Control Pushbutton 1 Events	0 to 1	---	1	F102	0 (Disabled)
D812	...Repeated for Control Pushbutton 2					
D814	...Repeated for Control Pushbutton 3					
D816	...Repeated for Control Pushbutton 4					
D818	...Repeated for Control Pushbutton 5					
D81A	...Repeated for Control Pushbutton 6					
D81C	...Repeated for Control Pushbutton 7					
Clear Records (Read/Write Setting)						
D821	Clear User Fault Reports operand	0 to 65535	---	1	F300	0
D822	Clear Event Records operand	0 to 65535	---	1	F300	0
D823	Clear Oscillography operand	0 to 65535	---	1	F300	0
D824	Clear Data Logger operand	0 to 65535	---	1	F300	0
D825	Clear Breaker 1 Arcing Current operand	0 to 65535	---	1	F300	0
D826	Clear Breaker 2 Arcing Current operand	0 to 65535	---	1	F300	0
D827	Clear Breaker 3 Arcing Current operand	0 to 65535	---	1	F300	0
D828	Clear Breaker 4 Arcing Current operand	0 to 65535	---	1	F300	0
D82B	Clear Demand operand	0 to 65535	---	1	F300	0
D82D	Clear Energy operand	0 to 65535	---	1	F300	0
D82F	Clear Unauthorized Access operand	0 to 65535	---	1	F300	0
D831	Clear Platform Direct Input/Output Statistics operand	0 to 65535	---	1	F300	0
D833	Reserved (13 items)	---	---	---	F001	0
Force Contact Inputs (Read/Write Setting)						
D8B0	Force Contact Input x State (96 items)	0 to 2	---	1	F144	0 (Disabled)
Force Contact Outputs (Read/Write Setting)						
D910	Force Contact Output x State (64 items)	0 to 3	---	1	F131	0 (Disabled)
Direct Inputs/Outputs (Read/Write Setting)						
DB40	Direct Device ID	1 to 16	---	1	F001	1
DB41	Direct I/O Channel 1 Ring Configuration Function	0 to 1	---	1	F126	0 (No)
DB42	Platform Direct I/O Data Rate	64 to 128	kbps	64	F001	64
DB43	Direct I/O Channel 2 Ring Configuration Function	0 to 1	---	1	F126	0 (No)
DB44	Platform Direct I/O Crossover Function	0 to 1	---	1	F102	0 (Disabled)

B

Table B-9: MODBUS MEMORY MAP (Sheet 39 of 43)

ADDR	REGISTER NAME	RANGE	UNITS	STEP	FORMAT	DEFAULT
Direct input/output commands (Read/Write Command)						
DB48	Direct input/output clear counters command	0 to 1	---	1	F126	0 (No)
Direct inputs (Read/Write Setting) (96 modules)						
DB50	Direct Input 1 Device Number	0 to 16	---	1	F001	0
DB51	Direct Input 1 Number	0 to 96	---	1	F001	0
DB52	Direct Input 1 Default State	0 to 3	---	1	F086	0 (Off)
DB53	Direct Input 1 Events	0 to 1	---	1	F102	0 (Disabled)
DB54	...Repeated for Direct Input 2					
DB58	...Repeated for Direct Input 3					
DB5C	...Repeated for Direct Input 4					
DB60	...Repeated for Direct Input 5					
DB64	...Repeated for Direct Input 6					
DB68	...Repeated for Direct Input 7					
DB6C	...Repeated for Direct Input 8					
DB70	...Repeated for Direct Input 9					
DB74	...Repeated for Direct Input 10					
DB78	...Repeated for Direct Input 11					
DB7C	...Repeated for Direct Input 12					
DB80	...Repeated for Direct Input 13					
DB84	...Repeated for Direct Input 14					
DB88	...Repeated for Direct Input 15					
DB8C	...Repeated for Direct Input 16					
DB90	...Repeated for Direct Input 17					
DB94	...Repeated for Direct Input 18					
DB98	...Repeated for Direct Input 19					
DB9C	...Repeated for Direct Input 20					
DBA0	...Repeated for Direct Input 21					
DBA4	...Repeated for Direct Input 22					
DBA8	...Repeated for Direct Input 23					
DBAC	...Repeated for Direct Input 24					
DBB0	...Repeated for Direct Input 25					
DBB4	...Repeated for Direct Input 26					
DBB8	...Repeated for Direct Input 27					
DBBC	...Repeated for Direct Input 28					
DBC0	...Repeated for Direct Input 29					
DBC4	...Repeated for Direct Input 30					
DBC8	...Repeated for Direct Input 31					
DBCC	...Repeated for Direct Input 32					
Platform Direct Outputs (Read/Write Setting) (96 modules)						
DD00	Direct Output 1 Operand	0 to 65535	---	1	F300	0
DD01	Direct Output 1 Events	0 to 1	---	1	F102	0 (Disabled)
DD02	...Repeated for Direct Output 2					
DD04	...Repeated for Direct Output 3					
DD06	...Repeated for Direct Output 4					
DD08	...Repeated for Direct Output 5					
DD0A	...Repeated for Direct Output 6					
DD0C	...Repeated for Direct Output 7					
DD0E	...Repeated for Direct Output 8					
DD10	...Repeated for Direct Output 9					
DD12	...Repeated for Direct Output 10					
DD14	...Repeated for Direct Output 11					
DD16	...Repeated for Direct Output 12					
DD18	...Repeated for Direct Output 13					
DD1A	...Repeated for Direct Output 14					

B

Table B-9: MODBUS MEMORY MAP (Sheet 40 of 43)

ADDR	REGISTER NAME	RANGE	UNITS	STEP	FORMAT	DEFAULT
DD1C	...Repeated for Direct Output 15					
DD1E	...Repeated for Direct Output 16					
DD20	...Repeated for Direct Output 17					
DD22	...Repeated for Direct Output 18					
DD24	...Repeated for Direct Output 19					
DD26	...Repeated for Direct Output 20					
DD28	...Repeated for Direct Output 21					
DD2A	...Repeated for Direct Output 22					
DD2C	...Repeated for Direct Output 23					
DD2E	...Repeated for Direct Output 24					
DD30	...Repeated for Direct Output 25					
DD32	...Repeated for Direct Output 26					
DD34	...Repeated for Direct Output 27					
DD36	...Repeated for Direct Output 28					
DD38	...Repeated for Direct Output 29					
DD3A	...Repeated for Direct Output 30					
DD3C	...Repeated for Direct Output 31					
DD3E	...Repeated for Direct Output 32					
Direct Input/Output Alarms (Read/Write Setting)						
DE00	Direct Input/Output Channel 1 CRC Alarm Function	0 to 1	---	1	F102	0 (Disabled)
DE01	Direct I/O Channel 1 CRC Alarm Message Count	100 to 10000	---	1	F001	600
DE02	Direct Input/Output Channel 1 CRC Alarm Threshold	1 to 1000	---	1	F001	10
DE03	Direct Input/Output Channel 1 CRC Alarm Events	0 to 1	---	1	F102	0 (Disabled)
DE04	Reserved (4 items)	1 to 1000	---	1	F001	10
DE08	Direct Input/Output Channel 2 CRC Alarm Function	0 to 1	---	1	F102	0 (Disabled)
DE09	Direct I/O Channel 2 CRC Alarm Message Count	100 to 10000	---	1	F001	600
DE0A	Direct Input/Output Channel 2 CRC Alarm Threshold	1 to 1000	---	1	F001	10
DE0B	Direct Input/Output Channel 2 CRC Alarm Events	0 to 1	---	1	F102	0 (Disabled)
DE0C	Reserved (4 items)	1 to 1000	---	1	F001	10
DE10	Direct I/O Ch 1 Unreturned Messages Alarm Function	0 to 1	---	1	F102	0 (Disabled)
DE11	Direct I/O Ch 1 Unreturned Messages Alarm Msg Count	100 to 10000	---	1	F001	600
DE12	Direct I/O Ch 1 Unreturned Messages Alarm Threshold	1 to 1000	---	1	F001	10
DE13	Direct I/O Ch 1 Unreturned Messages Alarm Events	0 to 1	---	1	F102	0 (Disabled)
DE14	Reserved (4 items)	1 to 1000	---	1	F001	10
DE18	Direct IO Ch 2 Unreturned Messages Alarm Function	0 to 1	---	1	F102	0 (Disabled)
DE19	Direct I/O Ch 2 Unreturned Messages Alarm Msg Count	100 to 10000	---	1	F001	600
DE1A	Direct I/O Ch 2 Unreturned Messages Alarm Threshold	1 to 1000	---	1	F001	10
DE1B	Direct I/O Channel 2 Unreturned Messages Alarm Events	0 to 1	---	1	F102	0 (Disabled)
DE1C	Reserved (4 items)	1 to 1000	---	1	F001	10
Remote Devices (Read/Write Setting) (16 modules)						
E000	Remote Device 1 ID	---	---	---	F202	"Remote Device 1"
E00A	Remote Device 1 Virtual LAN Identifier	0 to 4095	---	1	F001	0
E00B	Remote Device 1 Ethernet APPID	0 to 16383	---	1	F001	0
E00C	...Repeated for Device 2					
E018	...Repeated for Device 3					
E024	...Repeated for Device 4					
E030	...Repeated for Device 5					
E03C	...Repeated for Device 6					
E048	...Repeated for Device 7					
E054	...Repeated for Device 8					
E060	...Repeated for Device 9					
E06C	...Repeated for Device 10					
E078	...Repeated for Device 11					
E084	...Repeated for Device 12					

Table B-9: MODBUS MEMORY MAP (Sheet 41 of 43)

ADDR	REGISTER NAME	RANGE	UNITS	STEP	FORMAT	DEFAULT
E090	...Repeated for Device 13					
E09C	...Repeated for Device 14					
E0A8	...Repeated for Device 15					
E0B4	...Repeated for Device 16					
Remote Inputs (Read/Write Setting) (64 modules)						
E100	Remote Input 1 Device	1 to 16	---	1	F001	1
E101	Remote Input 1 Bit Pair	0 to 64	---	1	F156	0 (None)
E102	Remote Input 1 Default State	0 to 3	---	1	F086	0 (Off)
E103	Remote Input 1 Events	0 to 1	---	1	F102	0 (Disabled)
E104	Remote Input 1 Name	1 to 64	---	1	F205	"Rem Ip 1"
E10A	...Repeated for Remote Input 2					
E114	...Repeated for Remote Input 3					
E11E	...Repeated for Remote Input 4					
E128	...Repeated for Remote Input 5					
E132	...Repeated for Remote Input 6					
E13C	...Repeated for Remote Input 7					
E146	...Repeated for Remote Input 8					
E150	...Repeated for Remote Input 9					
E15A	...Repeated for Remote Input 10					
E164	...Repeated for Remote Input 11					
E16E	...Repeated for Remote Input 12					
E178	...Repeated for Remote Input 13					
E182	...Repeated for Remote Input 14					
E18C	...Repeated for Remote Input 15					
E196	...Repeated for Remote Input 16					
E1A0	...Repeated for Remote Input 17					
E1AA	...Repeated for Remote Input 18					
E1B4	...Repeated for Remote Input 19					
E1BE	...Repeated for Remote Input 20					
E1C8	...Repeated for Remote Input 21					
E1D2	...Repeated for Remote Input 22					
E1DC	...Repeated for Remote Input 23					
E1E6	...Repeated for Remote Input 24					
E1F0	...Repeated for Remote Input 25					
E1FA	...Repeated for Remote Input 26					
E204	...Repeated for Remote Input 27					
E20E	...Repeated for Remote Input 28					
E218	...Repeated for Remote Input 29					
E222	...Repeated for Remote Input 30					
E22C	...Repeated for Remote Input 31					
E236	...Repeated for Remote Input 32					
E240	...Repeated for Remote Input 33					
E24A	...Repeated for Remote Input 34					
E254	...Repeated for Remote Input 35					
E25E	...Repeated for Remote Input 36					
E268	...Repeated for Remote Input 37					
E272	...Repeated for Remote Input 38					
E27C	...Repeated for Remote Input 39					
E286	...Repeated for Remote Input 40					
E290	...Repeated for Remote Input 41					
E29A	...Repeated for Remote Input 42					
E2A4	...Repeated for Remote Input 43					
E2AE	...Repeated for Remote Input 44					
E2B8	...Repeated for Remote Input 45					

B

Table B-9: MODBUS MEMORY MAP (Sheet 42 of 43)

ADDR	REGISTER NAME	RANGE	UNITS	STEP	FORMAT	DEFAULT
E2C2	...Repeated for Remote Input 46					
E2CC	...Repeated for Remote Input 47					
E2D6	...Repeated for Remote Input 48					
E2E0	...Repeated for Remote Input 49					
E2EA	...Repeated for Remote Input 50					
E2F4	...Repeated for Remote Input 51					
E2FE	...Repeated for Remote Input 52					
E308	...Repeated for Remote Input 53					
E312	...Repeated for Remote Input 54					
E31C	...Repeated for Remote Input 55					
E326	...Repeated for Remote Input 56					
E330	...Repeated for Remote Input 57					
E33A	...Repeated for Remote Input 58					
E344	...Repeated for Remote Input 59					
E34E	...Repeated for Remote Input 60					
E358	...Repeated for Remote Input 61					
E362	...Repeated for Remote Input 62					
E36C	...Repeated for Remote Input 63					
E376	...Repeated for Remote Input 64					
Remote Output DNA Pairs (Read/Write Setting) (32 modules)						
E600	Remote Output DNA 1 Operand	0 to 65535	---	1	F300	0
E601	Remote Output DNA 1 Events	0 to 1	---	1	F102	0 (Disabled)
E602	Reserved (2 items)	0 to 1	---	1	F001	0
E604	...Repeated for Remote Output 2					
E608	...Repeated for Remote Output 3					
E60C	...Repeated for Remote Output 4					
E610	...Repeated for Remote Output 5					
E614	...Repeated for Remote Output 6					
E618	...Repeated for Remote Output 7					
E61C	...Repeated for Remote Output 8					
E620	...Repeated for Remote Output 9					
E624	...Repeated for Remote Output 10					
E628	...Repeated for Remote Output 11					
E62C	...Repeated for Remote Output 12					
E630	...Repeated for Remote Output 13					
E634	...Repeated for Remote Output 14					
E638	...Repeated for Remote Output 15					
E63C	...Repeated for Remote Output 16					
E640	...Repeated for Remote Output 17					
E644	...Repeated for Remote Output 18					
E648	...Repeated for Remote Output 19					
E64C	...Repeated for Remote Output 20					
E650	...Repeated for Remote Output 21					
E654	...Repeated for Remote Output 22					
E658	...Repeated for Remote Output 23					
E65C	...Repeated for Remote Output 24					
E660	...Repeated for Remote Output 25					
E664	...Repeated for Remote Output 26					
E668	...Repeated for Remote Output 27					
E66C	...Repeated for Remote Output 28					
E670	...Repeated for Remote Output 29					
E674	...Repeated for Remote Output 30					
E678	...Repeated for Remote Output 31					
E67C	...Repeated for Remote Output 32					

B

Table B-9: MODBUS MEMORY MAP (Sheet 43 of 43)

ADDR	REGISTER NAME	RANGE	UNITS	STEP	FORMAT	DEFAULT
Remote Output UserSt Pairs (Read/Write Setting) (32 modules)						
E680	Remote Output UserSt 1 Operand	0 to 65535	---	1	F300	0
E681	Remote Output UserSt 1 Events	0 to 1	---	1	F102	0 (Disabled)
E682	Reserved (2 items)	0 to 1	---	1	F001	0
E684	...Repeated for Remote Output 2					
E688	...Repeated for Remote Output 3					
E68C	...Repeated for Remote Output 4					
E690	...Repeated for Remote Output 5					
E694	...Repeated for Remote Output 6					
E698	...Repeated for Remote Output 7					
E69C	...Repeated for Remote Output 8					
E6A0	...Repeated for Remote Output 9					
E6A4	...Repeated for Remote Output 10					
E6A8	...Repeated for Remote Output 11					
E6AC	...Repeated for Remote Output 12					
E6B0	...Repeated for Remote Output 13					
E6B4	...Repeated for Remote Output 14					
E6B8	...Repeated for Remote Output 15					
E6BC	...Repeated for Remote Output 16					
E6C0	...Repeated for Remote Output 17					
E6C4	...Repeated for Remote Output 18					
E6C8	...Repeated for Remote Output 19					
E6CC	...Repeated for Remote Output 20					
E6D0	...Repeated for Remote Output 21					
E6D4	...Repeated for Remote Output 22					
E6D8	...Repeated for Remote Output 23					
E6DC	...Repeated for Remote Output 24					
E6E0	...Repeated for Remote Output 25					
E6E4	...Repeated for Remote Output 26					
E6E8	...Repeated for Remote Output 27					
E6EC	...Repeated for Remote Output 28					
E6F0	...Repeated for Remote Output 29					
E6F4	...Repeated for Remote Output 30					
E6F8	...Repeated for Remote Output 31					
E6FC	...Repeated for Remote Output 32					
Restricted Ground Fault (Read/Write Grouped Setting) (6 modules)						
EF00	Restricted Ground Fault 1 Function	0 to 1	---	1	F102	0 (Disabled)
EF01	Restricted Ground Fault 1 Source	0 to 5	---	1	F167	0 (SRC 1)
EF02	Restricted Ground Fault 1 Pickup	0 to 30	pu	0.001	F001	80
EF03	Restricted Ground Fault 1 Slope	0 to 100	%	1	F001	40
EF04	Restricted Ground Fault 1 Delay	0 to 600	s	0.01	F001	0
EF05	Restricted Ground Fault 1 Reset Delay	0 to 600	s	0.01	F001	0
EF06	Restricted Ground Fault 1 Block	---	---	---	F001	0
EF07	Restricted Ground Fault 1 Target	0 to 2	---	1	F109	0 (Self-reset)
EF08	Restricted Ground Fault 1 Events	0 to 1	---	1	F102	0 (Disabled)
EF09	...Repeated for Restricted Ground Fault 2					
EF12	...Repeated for Restricted Ground Fault 3					
EF1B	...Repeated for Restricted Ground Fault 4					
EF24	...Repeated for Restricted Ground Fault 5					
EF2D	...Repeated for Restricted Ground Fault 6					

B

B.4.2 DATA FORMATS

F001
UR_UINT16 UNSIGNED 16 BIT INTEGER

F002
UR_SINT16 SIGNED 16 BIT INTEGER

F003
UR_UINT32 UNSIGNED 32 BIT INTEGER (2 registers)

High order word is stored in the first register.
Low order word is stored in the second register.

F004
UR_SINT32 SIGNED 32 BIT INTEGER (2 registers)

High order word is stored in the first register/
Low order word is stored in the second register.

F005
UR_UINT8 UNSIGNED 8 BIT INTEGER

F006
UR_SINT8 SIGNED 8 BIT INTEGER

F011
UR_UINT16 FLEXCURVE DATA (120 points)

A FlexCurve is an array of 120 consecutive data points (x, y) which are interpolated to generate a smooth curve. The y-axis is the user defined trip or operation time setting; the x-axis is the pickup ratio and is pre-defined. Refer to format F119 for a listing of the pickup ratios; the enumeration value for the pickup ratio indicates the offset into the FlexCurve base address where the corresponding time value is stored.

F012
DISPLAY_SCALE DISPLAY SCALING
(unsigned 16-bit integer)

MSB indicates the SI units as a power of ten. LSB indicates the number of decimal points to display.

Example: Current values are stored as 32 bit numbers with three decimal places and base units in Amps. If the retrieved value is 12345.678 A and the display scale equals 0x0302 then the displayed value on the unit is 12.35 kA.

F013
POWER_FACTOR (SIGNED 16 BIT INTEGER)

Positive values indicate lagging power factor; negative values indicate leading.

F040
UR_UINT48 48-BIT UNSIGNED INTEGER

F050
UR_UINT32 TIME and DATE (UNSIGNED 32 BIT INTEGER)

Gives the current time in seconds elapsed since 00:00:00 January 1, 1970.

F051
UR_UINT32 DATE in SR format (alternate format for F050)

First 16 bits are Month/Day (MM/DD/xxxx). Month: 1=January, 2=February,...,12=December; Day: 1 to 31 in steps of 1
Last 16 bits are Year (xx/xx/YYYY): 1970 to 2106 in steps of 1

F052
UR_UINT32 TIME in SR format (alternate format for F050)

First 16 bits are Hours/Minutes (HH:MM:xx.xxx).
Hours: 0=12am, 1=1am,...,12=12pm,...23=11pm;
Minutes: 0 to 59 in steps of 1

Last 16 bits are Seconds (xx:xx:SS.SSS): 0=00.000s, 1=00.001,...,59999=59.999s)

F060
FLOATING_POINT IEEE FLOATING POINT (32 bits)

F070
HEX2 2 BYTES - 4 ASCII DIGITS

F071
HEX4 4 BYTES - 8 ASCII DIGITS

F072
HEX6 6 BYTES - 12 ASCII DIGITS

F073
HEX8 8 BYTES - 16 ASCII DIGITS

F074
HEX20 20 BYTES - 40 ASCII DIGITS

F083
ENUMERATION: SELECTOR MODES

0 = Time-Out, 1 = Acknowledge

F084
ENUMERATION: SELECTOR POWER UP

0 = Restore, 1 = Synchronize, 2 = Sync/Restore

F086
ENUMERATION: DIGITAL INPUT DEFAULT STATE
 0 = Off, 1 = On, 2 = Latest/Off, 3 = Latest/On

F090
ENUMERATION: LATCHING OUTPUT TYPE
 0 = Operate-dominant, 1 = Reset-dominant

F100
ENUMERATION: VT CONNECTION TYPE
 0 = Wye; 1 = Delta

F101
ENUMERATION: MESSAGE DISPLAY INTENSITY
 0 = 25%, 1 = 50%, 2 = 75%, 3 = 100%

F102
ENUMERATION: DISABLED/ENABLED
 0 = Disabled; 1 = Enabled

F103
ENUMERATION: CURVE SHAPES

bitmask	curve shape
0	IEEE Mod Inv
1	IEEE Very Inv
2	IEEE Ext Inv
3	IEC Curve A
4	IEC Curve B
5	IEC Curve C
6	IEC Short Inv
7	IAC Ext Inv
8	IAC Very Inv

bitmask	curve shape
9	IAC Inverse
10	IAC Short Inv
11	I2t
12	Definite Time
13	FlexCurve™ A
14	FlexCurve™ B
15	FlexCurve™ C
16	FlexCurve™ D

F104
ENUMERATION: RESET TYPE
 0 = Instantaneous, 1 = Timed, 2 = Linear

F105
ENUMERATION: LOGIC INPUT
 0 = Disabled, 1 = Input 1, 2 = Input 2

F106
ENUMERATION: PHASE ROTATION
 0 = ABC, 1 = ACB

F108
ENUMERATION: OFF/ON
 0 = Off, 1 = On

F109
ENUMERATION: CONTACT OUTPUT OPERATION
 0 = Self-reset, 1 = Latched, 2 = Disabled

F110
ENUMERATION: CONTACT OUTPUT LED CONTROL
 0 = Trip, 1 = Alarm, 2 = None

F111
ENUMERATION: UNDERVOLTAGE CURVE SHAPES
 0 = Definite Time, 1 = Inverse Time

F112
ENUMERATION: RS485 BAUD RATES

bitmask	value
0	300
1	1200
2	2400
3	4800

bitmask	value
4	9600
5	19200
6	38400
7	57600

bitmask	value
8	115200
9	14400
10	28800
11	33600

F113
ENUMERATION: PARITY
 0 = None, 1 = Odd, 2 = Even

F114
ENUMERATION: IRIG-B SIGNAL TYPE
 0 = None, 1 = DC Shift, 2 = Amplitude Modulated

F117
ENUMERATION: NUMBER OF OSCILLOGRAPHY RECORDS
 0 = 1×72 cycles, 1 = 3×36 cycles, 2 = 7×18 cycles, 3 = 15×9 cycles

F118
ENUMERATION: OSCILLOGRAPHY MODE
 0 = Automatic Overwrite, 1 = Protected

F119

ENUMERATION: FLEXCURVE™ PICKUP RATIOS

mask	value	mask	value	mask	value	mask	value
0	0.00	30	0.88	60	2.90	90	5.90
1	0.05	31	0.90	61	3.00	91	6.00
2	0.10	32	0.91	62	3.10	92	6.50
3	0.15	33	0.92	63	3.20	93	7.00
4	0.20	34	0.93	64	3.30	94	7.50
5	0.25	35	0.94	65	3.40	95	8.00
6	0.30	36	0.95	66	3.50	96	8.50
7	0.35	37	0.96	67	3.60	97	9.00
8	0.40	38	0.97	68	3.70	98	9.50
9	0.45	39	0.98	69	3.80	99	10.00
10	0.48	40	1.03	70	3.90	100	10.50
11	0.50	41	1.05	71	4.00	101	11.00
12	0.52	42	1.10	72	4.10	102	11.50
13	0.54	43	1.20	73	4.20	103	12.00
14	0.56	44	1.30	74	4.30	104	12.50
15	0.58	45	1.40	75	4.40	105	13.00
16	0.60	46	1.50	76	4.50	106	13.50
17	0.62	47	1.60	77	4.60	107	14.00
18	0.64	48	1.70	78	4.70	108	14.50
19	0.66	49	1.80	79	4.80	109	15.00
20	0.68	50	1.90	80	4.90	110	15.50
21	0.70	51	2.00	81	5.00	111	16.00
22	0.72	52	2.10	82	5.10	112	16.50
23	0.74	53	2.20	83	5.20	113	17.00
24	0.76	54	2.30	84	5.30	114	17.50
25	0.78	55	2.40	85	5.40	115	18.00
26	0.80	56	2.50	86	5.50	116	18.50
27	0.82	57	2.60	87	5.60	117	19.00
28	0.84	58	2.70	88	5.70	118	19.50
29	0.86	59	2.80	89	5.80	119	20.00

F122

ENUMERATION: ELEMENT INPUT SIGNAL TYPE

0 = Phasor, 1 = RMS

F123

ENUMERATION: CT SECONDARY

0 = 1 A, 1 = 5 A

F124

ENUMERATION: LIST OF ELEMENTS

bitmask	element
0	Phase Instantaneous Overcurrent 1
1	Phase Instantaneous Overcurrent 2
2	Phase Instantaneous Overcurrent 3
3	Phase Instantaneous Overcurrent 4
4	Phase Instantaneous Overcurrent 5

bitmask	element
5	Phase Instantaneous Overcurrent 6
6	Phase Instantaneous Overcurrent 7
7	Phase Instantaneous Overcurrent 8
8	Phase Instantaneous Overcurrent 9
9	Phase Instantaneous Overcurrent 10
10	Phase Instantaneous Overcurrent 11
11	Phase Instantaneous Overcurrent 12
16	Phase Time Overcurrent 1
17	Phase Time Overcurrent 2
18	Phase Time Overcurrent 3
19	Phase Time Overcurrent 4
20	Phase Time Overcurrent 5
21	Phase Time Overcurrent 6
24	Phase Directional Overcurrent 1
25	Phase Directional Overcurrent 2
32	Neutral Instantaneous Overcurrent 1
33	Neutral Instantaneous Overcurrent 2
34	Neutral Instantaneous Overcurrent 3
35	Neutral Instantaneous Overcurrent 4
36	Neutral Instantaneous Overcurrent 5
37	Neutral Instantaneous Overcurrent 6
38	Neutral Instantaneous Overcurrent 7
39	Neutral Instantaneous Overcurrent 8
40	Neutral Instantaneous Overcurrent 9
41	Neutral Instantaneous Overcurrent 10
42	Neutral Instantaneous Overcurrent 11
43	Neutral Instantaneous Overcurrent 12
48	Neutral Time Overcurrent 1
49	Neutral Time Overcurrent 2
50	Neutral Time Overcurrent 3
51	Neutral Time Overcurrent 4
52	Neutral Time Overcurrent 5
53	Neutral Time Overcurrent 6
56	Neutral Directional Overcurrent 1
57	Neutral Directional Overcurrent 2
60	Negative Sequence Directional Overcurrent 1
61	Negative Sequence Directional Overcurrent 2
64	Ground Instantaneous Overcurrent 1
65	Ground Instantaneous Overcurrent 2
66	Ground Instantaneous Overcurrent 3
67	Ground Instantaneous Overcurrent 4
68	Ground Instantaneous Overcurrent 5
69	Ground Instantaneous Overcurrent 6
70	Ground Instantaneous Overcurrent 7
71	Ground Instantaneous Overcurrent 8
72	Ground Instantaneous Overcurrent 9
73	Ground Instantaneous Overcurrent 10
74	Ground Instantaneous Overcurrent 11
75	Ground Instantaneous Overcurrent 12
80	Ground Time Overcurrent 1
81	Ground Time Overcurrent 2
82	Ground Time Overcurrent 3
83	Ground Time Overcurrent 4

B

bitmask	element
84	Ground Time Overcurrent 5
85	Ground Time Overcurrent 6
86	Restricted Ground Fault 1
87	Restricted Ground Fault 2
88	Restricted Ground Fault 3
89	Restricted Ground Fault 4
90	Restricted Ground Fault 5
91	Restricted Ground Fault 6
96	Negative Sequence Instantaneous Overcurrent 1
97	Negative Sequence Instantaneous Overcurrent 2
112	Negative Sequence Time Overcurrent 1
113	Negative Sequence Time Overcurrent 2
120	Negative Sequence Overvoltage
140	Auxiliary Undervoltage 1
144	Phase Undervoltage 1
145	Phase Undervoltage 2
148	Auxiliary Overvoltage 1
152	Phase Overvoltage 1
156	Neutral Overvoltage 1
180	Load Enchroachment
190	Power Swing Detect
202	Transformer Hottest Spot
203	Transformer Aging Factor
204	Transformer Loss of Life
208	Transformer Instantaneous
209	Transformer Percent Differential
210	Volt per Hertz 1
211	Volt per Hertz 2
280	Breaker Failure 1
281	Breaker Failure 2
280	Breaker Failure 3
281	Breaker Failure 4
288	Breaker Arcing Current 1
289	Breaker Arcing Current 2
290	Breaker Arcing Current 3
291	Breaker Arcing Current 4
292	Breaker Arcing Current 5
293	Breaker Arcing Current 6
336	Setting Group
337	Reset
385	Selector 1
386	Selector 2
390	Control Pushbutton 1
391	Control Pushbutton 2
392	Control Pushbutton 3
393	Control Pushbutton 4
394	Control Pushbutton 5
395	Control Pushbutton 6
396	Control Pushbutton 7
400	FlexElement™ 1
401	FlexElement™ 2
402	FlexElement™ 3
403	FlexElement™ 4

bitmask	element
404	FlexElement™ 5
405	FlexElement™ 6
406	FlexElement™ 7
407	FlexElement™ 8
408	FlexElement™ 9
409	FlexElement™ 10
410	FlexElement™ 11
411	FlexElement™ 12
412	FlexElement™ 13
413	FlexElement™ 14
414	FlexElement™ 15
415	FlexElement™ 16
420	Non-volatile Latch 1
421	Non-volatile Latch 2
422	Non-volatile Latch 3
423	Non-volatile Latch 4
424	Non-volatile Latch 5
425	Non-volatile Latch 6
426	Non-volatile Latch 7
427	Non-volatile Latch 8
428	Non-volatile Latch 9
429	Non-volatile Latch 10
430	Non-volatile Latch 11
431	Non-volatile Latch 12
432	Non-volatile Latch 13
433	Non-volatile Latch 14
434	Non-volatile Latch 15
435	Non-volatile Latch 16
544	Digital Counter 1
545	Digital Counter 2
546	Digital Counter 3
547	Digital Counter 4
548	Digital Counter 5
549	Digital Counter 6
550	Digital Counter 7
551	Digital Counter 8
680	User-Programmable Pushbutton 1
681	User-Programmable Pushbutton 2
682	User-Programmable Pushbutton 3
683	User-Programmable Pushbutton 4
684	User-Programmable Pushbutton 5
685	User-Programmable Pushbutton 6
686	User-Programmable Pushbutton 7
687	User-Programmable Pushbutton 8
688	User-Programmable Pushbutton 9
689	User-Programmable Pushbutton 10
690	User-Programmable Pushbutton 11
691	User-Programmable Pushbutton 12
692	Digital Element 1
693	Digital Element 2
694	Digital Element 3
695	Digital Element 4
696	Digital Element 5

bitmask	element
697	Digital Element 6
698	Digital Element 7
699	Digital Element 8
700	Digital Element 9
701	Digital Element 10
702	Digital Element 11
703	Digital Element 12
704	Digital Element 13
705	Digital Element 14
706	Digital Element 15
707	Digital Element 16
708	Digital Element 17
709	Digital Element 18
710	Digital Element 19
711	Digital Element 20
712	Digital Element 21
713	Digital Element 22
714	Digital Element 23
715	Digital Element 24
716	Digital Element 25
717	Digital Element 26
718	Digital Element 27
719	Digital Element 28
720	Digital Element 29
721	Digital Element 30
722	Digital Element 31
723	Digital Element 32
724	Digital Element 33
725	Digital Element 34
726	Digital Element 35
727	Digital Element 36
728	Digital Element 37
729	Digital Element 38
730	Digital Element 39
731	Digital Element 40
732	Digital Element 41
733	Digital Element 42
734	Digital Element 43
735	Digital Element 44
736	Digital Element 45
737	Digital Element 46
738	Digital Element 47
739	Digital Element 48

F125
ENUMERATION: ACCESS LEVEL

0 = Restricted; 1 = Command, 2 = Setting, 3 = Factory Service

F126
ENUMERATION: NO/YES CHOICE

0 = No, 1 = Yes

F127
ENUMERATION: LATCHED OR SELF-RESETTING

0 = Latched, 1 = Self-Reset

F128
ENUMERATION: CONTACT INPUT THRESHOLD

0 = 17 V DC, 1 = 33 V DC, 2 = 84 V DC, 3 = 166 V DC

F129
ENUMERATION: FLEXLOGIC TIMER TYPE

0 = millisecond, 1 = second, 2 = minute

F130
ENUMERATION: SIMULATION MODE

0 = Off. 1 = Pre-Fault, 2 = Fault, 3 = Post-Fault

F131
ENUMERATION: FORCED CONTACT OUTPUT STATE

0 = Disabled, 1 = Energized, 2 = De-energized, 3 = Freeze

F132
ENUMERATION: DEMAND INTERVAL

0 = 5 min, 1 = 10 min, 2 = 15 min, 3 = 20 min, 4 = 30 min,
5 = 60 min

F133
ENUMERATION: PROGRAM STATE

0 = Not Programmed, 1 = Programmed

F134
ENUMERATION: PASS/FAIL

0 = Fail, 1 = OK, 2 = n/a

F135
ENUMERATION: GAIN CALIBRATION

0 = 0x1, 1 = 1x16

F136
ENUMERATION: NUMBER OF OSCILLOGRAPHY RECORDS

0 = 31 x 8 cycles, 1 = 15 x 16 cycles, 2 = 7 x 32 cycles
3 = 3 x 64 cycles, 4 = 1 x 128 cycles

F138
ENUMERATION: OSCILLOGRAPHY FILE TYPE

0 = Data File, 1 = Configuration File, 2 = Header File

B

F139

ENUMERATION: DEMAND CALCULATIONS

0 = Thermal Exponential, 1 = Block Interval, 2 = Rolling Demand

F140

ENUMERATION: CURRENT, SENS CURRENT, VOLTAGE, DISABLED

0 = Disabled, 1 = Current 46 A, 2 = Voltage 280 V, 3 = Current 4.6 A, 4 = Current 2 A, 5 = Notched 4.6 A, 6 = Notched 2 A

F141

ENUMERATION: SELF TEST ERROR

bitmask	error
0	Any Self Tests
1	IRIG-B Failure
2	DSP Error
4	No DSP Interrupts
5	Unit Not Calibrated
9	Prototype Firmware
10	Flexlogic Error Token
11	Equipment Mismatch
13	Unit Not Programmed
14	System Exception
15	Latching Out Error
18	SNTP Failure
19	Battery Failure
20	Primary Ethernet Failure
21	Secondary Ethernet Failure
22	EEPROM Data Error
23	SRAM Data Error
24	Program Memory
25	Watchdog Error
26	Low On Memory
27	Remote Device Off
28	Direct Device Off
29	Direct Ring Break
30	Any Minor Error
31	Any Major Error

F142

ENUMERATION: EVENT RECORDER ACCESS FILE TYPE

0 = All Record Data, 1 = Headers Only, 2 = Numeric Event Cause

F143

UR_UINT32: 32 BIT ERROR CODE (F141 specifies bit number)

A bit value of 0 = no error, 1 = error

F144

ENUMERATION: FORCED CONTACT INPUT STATE

0 = Disabled, 1 = Open, 2 = Closed

F145

ENUMERATION: ALPHABET LETTER

bitmask	type	bitmask	type	bitmask	type	bitmask	type
0	null	7	G	14	N	21	U
1	A	8	H	15	O	22	V
2	B	9	I	16	P	23	W
3	C	10	J	17	Q	24	X
4	D	11	K	18	R	25	Y
5	E	12	L	19	S	26	Z
6	F	13	M	20	T		

F146

ENUMERATION: MISC. EVENT CAUSES

bitmask	definition
0	Events Cleared
1	Oscillography Triggered
2	Date/time Changed
3	Default Settings Loaded
4	Test Mode On
5	Test Mode Off
6	Power On
7	Power Off
8	Relay In Service
9	Relay Out Of Service
10	Watchdog Reset
11	Oscillography Clear
12	Reboot Command
13	Led Test Initiated
14	Flash Programming
15	Fault Report Trigger
16	User Programmable Fault Report Trigger
17	Corrupt DSP Program
18	Reload DSP Settings

F151

ENUMERATION: RTD SELECTION

bitmask	RTD#	bitmask	RTD#	bitmask	RTD#
0	NONE	17	RTD 17	33	RTD 33
1	RTD 1	18	RTD 18	34	RTD 34
2	RTD 2	19	RTD 19	35	RTD 35
3	RTD 3	20	RTD 20	36	RTD 36
4	RTD 4	21	RTD 21	37	RTD 37
5	RTD 5	22	RTD 22	38	RTD 38
6	RTD 6	23	RTD 23	39	RTD 39
7	RTD 7	24	RTD 24	40	RTD 40
8	RTD 8	25	RTD 25	41	RTD 41
9	RTD 9	26	RTD 26	42	RTD 42
10	RTD 10	27	RTD 27	43	RTD 43
11	RTD 11	28	RTD 28	44	RTD 44
12	RTD 12	29	RTD 29	45	RTD 45
13	RTD 13	30	RTD 30	46	RTD 46
14	RTD 14	31	RTD 31	47	RTD 47
15	RTD 15	32	RTD 32	48	RTD 48
16	RTD 16				

F152

ENUMERATION: SETTING GROUP

0 = Active Group, 1 = Group 1, 2 = Group 2, 3 = Group 3
 4 = Group 4, 5 = Group 5, 6 = Group 6

F153

ENUMERATION: DISTANCE TRANSFORMER CONNECTION

bitmask	type	bitmask	type	bitmask	type
0	None	5	Dy9	10	Yd7
1	Dy1	6	Dy11	11	Yd9
2	Dy3	7	Yd1	12	Yd11
3	Dy5	8	Yd3		
4	Dy7	9	Yd5		

F155

ENUMERATION: REMOTE DEVICE STATE

0 = Offline, 1 = Online

F156

ENUMERATION: REMOTE INPUT BIT PAIRS

bitmask	RTD#	bitmask	RTD#	bitmask	RTD#
0	NONE	22	DNA-22	44	UserSt-12
1	DNA-1	23	DNA-23	45	UserSt-13
2	DNA-2	24	DNA-24	46	UserSt-14
3	DNA-3	25	DNA-25	47	UserSt-15
4	DNA-4	26	DNA-26	48	UserSt-16
5	DNA-5	27	DNA-27	49	UserSt-17
6	DNA-6	28	DNA-28	50	UserSt-18
7	DNA-7	29	DNA-29	51	UserSt-19
8	DNA-8	30	DNA-30	52	UserSt-20
9	DNA-9	31	DNA-31	53	UserSt-21
10	DNA-10	32	DNA-32	54	UserSt-22
11	DNA-11	33	UserSt-1	55	UserSt-23
12	DNA-12	34	UserSt-2	56	UserSt-24
13	DNA-13	35	UserSt-3	57	UserSt-25
14	DNA-14	36	UserSt-4	58	UserSt-26
15	DNA-15	37	UserSt-5	59	UserSt-27
16	DNA-16	38	UserSt-6	60	UserSt-28
17	DNA-17	39	UserSt-7	61	UserSt-29
18	DNA-18	40	UserSt-8	62	UserSt-30
19	DNA-19	41	UserSt-9	63	UserSt-31
20	DNA-20	42	UserSt-10	64	UserSt-32
21	DNA-21	43	UserSt-11		

F160

ENUMERATION: TRANSFORMER PHASE COMPENSATION

0 = Internal (software), 1 = External (with CTs)

F161

ENUMERATION: TRANSFORMER RATED WINDING TEMPERATURE RISE

0 = 55°C (oil), 1 = 65°C (oil), 2 = 80°C (dry), 3 = 115°C (dry),
 4 = 150°C (dry)

F162

ENUMERATION: TRANSFORMER TYPE OF COOLING

0 = OA, 1 = FA, 2 = Non-directed FOA/FOW,
 3 = Directed FOA/FOW, 4 = Sealed Self Cooled,
 5 = Vented Self Cooled, 6 = Forced Cooled

F163

ENUMERATION: TRANSFORMER WINDING CONNECTION

0 = Wye, 1 = Delta, 2 = Zig-zag

F164

ENUMERATION: TRANSFORMER WINDING GROUNDING

0 = Not within zone, 1 = Within zone

F165

ENUMERATION: TRANSFORMER TAP INPUT

0 = None, 1 = Tap Input 1, 2 = Tap Input 2, 3 = Auto-detect

F166

ENUMERATION: AUXILIARY VT CONNECTION TYPE

0 = Vn, 1 = Vag, 2 = Vbg, 3 = Vcg, 4 = Vab, 5 = Vbc, 6 = Vca

F167

ENUMERATION: SIGNAL SOURCE

0 = SRC 1, 1 = SRC 2, 2 = SRC 3, 3 = SRC 4, 4 = SRC 5, 5 = SRC 6

F168

ENUMERATION: INRUSH INHIBIT FUNCTION

0 = Disabled, 1 = Adapt. 2nd, 2 = Trad. 2nd

F169

ENUMERATION: OVEREXCITATION INHIBIT FUNCTION

0 = Disabled, 1 = 5th

F170

ENUMERATION: LOW/HIGH OFFSET and GAIN TRANSDUCE INPUT/OUTPUT SELECTION

0 = LOW, 1 = HIGH

F171

ENUMERATION: TRANSDUCE CHANNEL INPUT TYPE

0 = dcmA IN, 1 = Ohms IN, 2 = RTD IN, 3 = dcmA OUT

F172

ENUMERATION: SLOT LETTERS

bitmask	slot	bitmask	slot	bitmask	slot	bitmask	slot
0	F	4	K	8	P	12	U
1	G	5	L	9	R	13	V
2	H	6	M	10	S	14	W
3	J	7	N	11	T	15	X

F173

ENUMERATION: TRANSDUCE DCMA I/O RANGE

bitmask	dcmA I/O range
0	0 to -1 mA
1	0 to 1 mA
2	-1 to 1 mA
3	0 to 5 mA
4	0 to 10 mA
5	0 to 20 mA
6	4 to 20 mA

F174

ENUMERATION: TRANSDUCE RTD INPUT TYPE

0 = 100 Ohm Platinum, 1 = 120 Ohm Nickel, 2 = 100 Ohm Nickel, 3 = 10 Ohm Copper

F175

ENUMERATION: PHASE LETTERS

0 = A, 1 = B, 2 = C

F177

ENUMERATION: COMMUNICATION PORT

0 = None, 1 = COM1-RS485, 2 = COM2-RS485, 3 = Front Panel-RS232, 4 = Network

F180

ENUMERATION: PHASE/GROUND

0 = PHASE, 1 = GROUND

F181

ENUMERATION: ODD/EVEN/NONE

0 = ODD, 1 = EVEN, 2 = NONE

F183

ENUMERATION: AC INPUT WAVEFORMS

bitmask	definition
0	Off
1	8 samples/cycle
2	16 samples/cycle
3	32 samples/cycle
4	64 samples/cycle

F185

ENUMERATION: PHASE A,B,C, GROUND SELECTOR

0 = A, 1 = B, 2 = C, 3 = G

F186

ENUMERATION: MEASUREMENT MODE

0 = Phase to Ground, 1 = Phase to Phase

F189

ENUMERATION: INRUSH INHIBIT MODE

0 = Per Phase, 1 = 2-out-of-3, 2 = Average

F190
ENUMERATION: SIMULATED KEYPRESS

bitmsk	keypress	bitmsk	keypress
0	--- use between real keys	21	Escape
1	1	22	Enter
2	2	23	Reset
3	3	24	User 1
4	4	25	User 2
5	5	26	User 3
6	6	27	User-programmable key 1
7	7	28	User-programmable key 2
8	8	29	User-programmable key 3
9	9	30	User-programmable key 4
10	0	31	User-programmable key 5
11	Decimal Pt	32	User-programmable key 6
12	Plus/Minus	33	User-programmable key 7
13	Value Up	34	User-programmable key 8
14	Value Down	35	User-programmable key 9
15	Message Up	36	User-programmable key 10
16	Message Down	37	User-programmable key 11
17	Message Left	38	User-programmable key 12
18	Message Right	39	User 4 (control pushbutton)
19	Menu	40	User 5 (control pushbutton)
20	Help	41	User 6 (control pushbutton)
		42	User 7 (control pushbutton)

F192
ENUMERATION: ETHERNET OPERATION MODE

0 = Half-Duplex, 1 = Full-Duplex

F194
ENUMERATION: DNP SCALE

A bitmask of 0 = 0.01, 1 = 0.1, 2 = 1, 3 = 10, 4 = 100, 5 = 1000, 6 = 10000, 7 = 100000, 8 = 0.001

F199
ENUMERATION: DISABLED/ENABLED/CUSTOM

0 = Disabled, 1 = Enabled, 2 = Custom

F200
TEXT40: 40-CHARACTER ASCII TEXT

20 registers, 16 Bits: 1st Char MSB, 2nd Char. LSB

F201
TEXT8: 8-CHARACTER ASCII PASSCODE

4 registers, 16 Bits: 1st Char MSB, 2nd Char. LSB

F202
TEXT20: 20-CHARACTER ASCII TEXT

10 registers, 16 Bits: 1st Char MSB, 2nd Char. LSB

F203
TEXT16: 16-CHARACTER ASCII TEXT

F204
TEXT80: 80-CHARACTER ASCII TEXT

F205
TEXT12: 12-CHARACTER ASCII TEXT

F206
TEXT6: 6-CHARACTER ASCII TEXT

F207
TEXT4: 4-CHARACTER ASCII TEXT

F208
TEXT2: 2-CHARACTER ASCII TEXT

F222
ENUMERATION: TEST ENUMERATION

0 = Test Enumeration 0, 1 = Test Enumeration 1

F226
ENUMERATION: REMOTE INPUT/OUTPUT TRANSFER METHOD

0 = None, 1 = GSSE, 2 = GOOSE

F227
ENUMERATION: RELAY SERVICE STATUS

0 = Unknown, 1 = Relay In Service, 2 = Relay Out Of Service

F230
ENUMERATION: DIRECTIONAL POLARIZING

0 = Voltage, 1 = Current, 2 = Dual

F231
ENUMERATION: POLARIZING VOLTAGE

0 = Calculated V0, 1 = Measured VX

F240
ENUMERATION: V/HZ CURVES

0 = Definite Time, 1 = Inverse A, 2 = Inverse B, 3 = Inverse C, 4 = FlexCurve™ A, 5 = FlexCurve™ B, 6 = FlexCurve™ C, 7 = FlexCurve™ D

F300

UR_UINT16: FLEXLOGIC™ BASE TYPE (6-bit type)

The FlexLogic™ BASE type is 6 bits and is combined with a 9 bit descriptor and 1 bit for protection element to form a 16 bit value. The combined bits are of the form: PTTTTTDDDDDDDDDD, where P bit if set, indicates that the FlexLogic™ type is associated with a protection element state and T represents bits for the BASE type, and D represents bits for the descriptor.

The values in square brackets indicate the base type with P prefix [PTTTTTT] and the values in round brackets indicate the descriptor range.

- [0] Off(0) – this is boolean FALSE value
- [0] On (1) – this is boolean TRUE value
- [2] CONTACT INPUTS (1 to 96)
- [3] CONTACT INPUTS OFF (1 to 96)
- [4] VIRTUAL INPUTS (1 to 64)
- [6] VIRTUAL OUTPUTS (1 to 96)
- [10] CONTACT OUTPUTS VOLTAGE DETECTED (1 to 64)
- [11] CONTACT OUTPUTS VOLTAGE OFF DETECTED (1 to 64)
- [12] CONTACT OUTPUTS CURRENT DETECTED (1 to 64)
- [13] CONTACT OUTPUTS CURRENT OFF DETECTED (1 to 64)
- [14] REMOTE INPUTS (1 to 32)
- [28] INSERT (via keypad only)
- [32] END
- [34] NOT (1 INPUT)
- [36] 2 INPUT XOR (0)
- [38] LATCH SET/RESET (2 inputs)
- [40] OR (2 to 16 inputs)
- [42] AND (2 to 16 inputs)
- [44] NOR (2 to 16 inputs)
- [46] NAND (2 to 16 inputs)
- [48] TIMER (1 to 32)
- [50] ASSIGN VIRTUAL OUTPUT (1 to 96)
- [52] SELF-TEST ERROR (see F141 for range)
- [56] ACTIVE SETTING GROUP (1 to 6)
- [62] MISCELLANEOUS EVENTS (see F146 for range)
- [64 to 127] ELEMENT STATES

F400

UR_UINT16: CT/VT BANK SELECTION

bitmask	bank selection
0	Card 1 Contact 1 to 4
1	Card 1 Contact 5 to 8
2	Card 2 Contact 1 to 4
3	Card 2 Contact 5 to 8
4	Card 3 Contact 1 to 4
5	Card 3 Contact 5 to 8

F500

UR_UINT16: PACKED BITFIELD

First register indicates input/output state with bits 0 (MSB) to 15 (LSB) corresponding to input/output state 1 to 16. The second register indicates input/output state with bits 0 to 15 corresponding to input/output state 17 to 32 (if required) The third register indicates input/output state with bits 0 to 15 corresponding to input/output

state 33 to 48 (if required). The fourth register indicates input/output state with bits 0 to 15 corresponding to input/output state 49 to 64 (if required).

The number of registers required is determined by the specific data item. A bit value of 0 = Off and 1 = On.

F501

UR_UINT16: LED STATUS

Low byte of register indicates LED status with bit 0 representing the top LED and bit 7 the bottom LED. A bit value of 1 indicates the LED is on, 0 indicates the LED is off.

F502

BITFIELD: ELEMENT OPERATE STATES

Each bit contains the operate state for an element. See the F124 format code for a list of element IDs. The operate bit for element ID X is bit [X mod 16] in register [X/16].

F504

BITFIELD: 3-PHASE ELEMENT STATE

bitmask	element state
0	Pickup
1	Operate
2	Pickup Phase A
3	Pickup Phase B
4	Pickup Phase C
5	Operate Phase A
6	Operate Phase B
7	Operate Phase C

F505

BITFIELD: CONTACT OUTPUT STATE

0 = Contact State, 1 = Voltage Detected, 2 = Current Detected

F506|

BITFIELD: 1 PHASE ELEMENT STATE

0 = Pickup, 1 = Operate

F507

BITFIELD: COUNTER ELEMENT STATE

0 = Count Greater Than, 1 = Count Equal To, 2 = Count Less Than

F509

BITFIELD: SIMPLE ELEMENT STATE

0 = Operate

F511

BITFIELD: 3-PHASE SIMPLE ELEMENT STATE

0 = Operate, 1 = Operate A, 2 = Operate B, 3 = Operate C

F512
ENUMERATION: HARMONIC NUMBER

bitmask	harmonic	bitmask	harmonic
0	2ND	12	14TH
1	3RD	13	15TH
2	4TH	14	16TH
3	5TH	15	17TH
4	6TH	16	18TH
5	7TH	17	19TH
6	8TH	18	20TH
7	9TH	19	21ST
8	10TH	20	22ND
9	11TH	21	23RD
10	12TH	22	24TH
11	13TH	23	25TH

F515
ENUMERATION ELEMENT INPUT MODE

0 = Signed, 1 = Absolute

F516
ENUMERATION ELEMENT COMPARE MODE

0 = Level, 1 = Delta

F517
ENUMERATION: ELEMENT DIRECTION OPERATION

0 = Over, 1 = Under

F518
ENUMERATION: FLEXELEMENT™ UNITS

0 = Milliseconds, 1 = Seconds, 2 = Minutes

F519
ENUMERATION: NON-VOLATILE LATCH

0 = Reset-Dominant, 1 = Set-Dominant

F520
ENUMERATION: TRANSFORMER REFERENCE WINDING

bitmask	Transformer Reference Winding
0	Automatic Selection
1	Winding 1
2	Winding 2
3	Winding 3
4	Winding 4
5	Winding 5
6	Winding 6

F522
ENUMERATION: TRANSDUCER DCMA OUTPUT RANGE

0 = -1 to 1 mA; 1 = 0 to 1 mA; 2 = 4 to 20 mA

F523
ENUMERATION: DNP OBJECTS 20, 22, AND 23 DEFAULT VARIATION

bitmask	Default Variation
0	1
1	2
2	5
3	6

F524
ENUMERATION: DNP OBJECT 21 DEFAULT VARIATION

bitmask	Default Variation
0	1
1	2
2	9
3	10

F525
ENUMERATION: DNP OBJECT 32 DEFAULT VARIATION

bitmask	Default Variation
0	1
1	2
2	3
3	4
4	5
5	7

F530**ENUMERATION: FRONT PANEL INTERFACE KEYPRESS**

bitmask	keypress	bitmask	keypress
0	None	22	Value Down
1	Menu	23	Reset
2	Message Up	24	User 1
3	7	25	User 2
4	8	26	User 3
5	9	31	User PB 1
6	Help	32	User PB 2
7	Message Left	33	User PB 3
8	4	34	User PB 4
9	5	35	User PB 5
10	6	36	User PB 6
11	Escape	37	User PB 7
12	Message Right	38	User PB 8
13	1	39	User PB 9
14	2	40	User PB 10
15	3	41	User PB 11
16	Enter	42	User PB 12
17	Message Down	44	User 4
18	0	45	User 5
19	Decimal	46	User 6
20	+/-	47	User 7
21	Value Up		

F531**ENUMERATION: LANGUAGE**

0 = English, 1 = French, 2 = Chinese, 3 = Russian

F600**UR_UINT16: FLEXANALOG PARAMETER**

Corresponds to the modbus address of the value used when this parameter is selected. Only certain values may be used as FlexAnalog (basically all metering quantities used in protection).

C.1.1 OVERVIEW

The IEC 61850 standard is the result of years of work by electric utilities and vendors of electronic equipment to produce standardized communications systems. IEC 61850 is a series of standards describing client/server and peer-to-peer communications, substation design and configuration, testing, environmental and project standards. The complete set includes:

- IEC 61850-1: Introduction and overview
- IEC 61850-2: Glossary
- IEC 61850-3: General requirements
- IEC 61850-4: System and project management
- IEC 61850-5: Communications and requirements for functions and device models
- IEC 61850-6: Configuration description language for communication in electrical substations related to IEDs
- IEC 61850-7-1: Basic communication structure for substation and feeder equipment - Principles and models
- IEC 61850-7-2: Basic communication structure for substation and feeder equipment - Abstract communication service interface (ACSI)
- IEC 61850-7-3: Basic communication structure for substation and feeder equipment – Common data classes
- IEC 61850-7-4: Basic communication structure for substation and feeder equipment – Compatible logical node classes and data classes
- IEC 61850-8-1: Specific Communication Service Mapping (SCSM) – Mappings to MMS (ISO 9506-1 and ISO 9506-2) and to ISO/IEC 8802-3
- IEC 61850-9-1: Specific Communication Service Mapping (SCSM) – Sampled values over serial unidirectional multi-drop point to point link
- IEC 61850-9-2: Specific Communication Service Mapping (SCSM) – Sampled values over ISO/IEC 8802-3
- IEC 61850-10: Conformance testing

These documents can be obtained from the IEC (<http://www.iec.ch>). It is strongly recommended that all those involved with any IEC 61850 implementation obtain this document set.

C.1.2 COMMUNICATION PROFILES

The T60 relay supports IEC 61850 server services over both TCP/IP and TP4/CLNP (OSI) communication protocol stacks. The TP4/CLNP profile requires the T60 to have a network address or Network Service Access Point (NSAP) to establish a communication link. The TCP/IP profile requires the T60 to have an IP address to establish communications. These addresses are located in the **SETTINGS** ⇒ **PRODUCT SETUP** ⇒ **COMMUNICATIONS** ⇒ **NETWORK** menu. Note that the T60 supports IEC 61850 over the TP4/CLNP or TCP/IP stacks, and also operation over both stacks simultaneously. It is possible to have up to four simultaneous connections (in addition to DNP and Modbus/TCP (non-IEC 61850) connections).

C.1.3 MMS PROTOCOL

IEC 61850 specifies the use of the Manufacturing Message Specification (MMS) at the upper (application) layer for transfer of real-time data. This protocol has been in existence for a number of years and provides a set of services suitable for the transfer of data within a substation LAN environment. Actual MMS protocol services are mapped to IEC 61850 abstract services in IEC 61850-8-1.

C.1.4 PEER-TO-PEER COMMUNICATION

Peer-to-peer communication of digital state information (remote inputs/outputs) is supported using the IEC 61850 GSSE and GOOSE services. This feature allows digital points to be exchanged between IEC 61850 conforming devices.

C.1.5 FILE SERVICES

MMS file services are supported to allow transfer of oscillography, event record, or other files from a T60 relay.

C.1.6 COMMUNICATION SOFTWARE UTILITIES

The exact structure and values of the supported IEC 61850 logical nodes can be seen by connecting to a T60 relay with an MMS browser, such as the “MMS Object Explorer and AXS4-MMS” DDE/OPC server from Sisco Inc.

C.1.7 NON-IEC 61850 DATA

The T60 relay makes available a number of non-IEC 61850 data items. These data items can be accessed through the “UR” MMS domain. IEC 61850 data can be accessed through the “IECDevice” MMS domain (IEC 61850 logical device).

C.1.8 TCP CONNECTION TIMING

A built-in TCP/IP connection timeout of two minutes is employed by the T60 to detect ‘dead’ connections. If there is no data traffic on a TCP connection for greater than two minutes, the connection will be aborted by the T60. This frees up the connection to be used by other clients. Therefore, when using IEC 61850 reporting, clients should configure report control block items such that an integrity report will be issued at least every 2 minutes (120000 ms). This ensures that the T60 will not abort the connection. If other MMS data is being polled on the same connection at least once every 2 minutes, this timeout will not apply.

C.1.9 LOGICAL NODE MMXU DATA MAPPING

The mapping of T60 relay data to IEC 61850 MMXU data is performed on a per-source basis. MMXU1 data originates from T60 source 1, MMXU2 data originates from T60 source 2, etc.

C.1.10 LOGICAL NODE GGIO DATA MAPPING

Logical node GGIO1 data is mapped using the T60 Flexstate parameters. Each single point indication in GGIO1 can be selected using the corresponding Flexstate parameter setting. For example, the value of GGIO1 point “Ind3” is determined from the FlexLogic™ operand selected in the Flexstate parameter 3 setting. Thus, GGIO1 data can originate as any FlexLogic™ parameter.

Logical node GGIO2 data is mapped to the T60 virtual inputs. Each single point control in GGIO2 is mapped to a virtual input. For example, GGIO2 control point SPCSO3 is mapped to virtual input 3.

C.1.11 OTHER LOGICAL NODE MAPPING

All other IEC 61850 logical nodes (with the exception of PTRC) are associated with standard UR-series relay protection elements and features. The following mapping is used (for applicable elements):

- PIOC: phase instantaneous overcurrent, neutral instantaneous overcurrent, ground instantaneous overcurrent, negative sequence instantaneous overcurrent
- PTOC: phase time overcurrent, neutral time overcurrent, ground time overcurrent, negative sequence time overcurrent, neutral directional overcurrent, negative sequence directional overcurrent
- PTUV: phase undervoltage, auxiliary undervoltage, third harmonic neutral undervoltage
- PTOV: phase overvoltage, neutral overvoltage, auxiliary overvoltage, negative sequence overvoltage

C.2.1 ACSI BASIC CONFORMANCE STATEMENT

SERVICES		SERVER/ PUBLISHER	UR-FAMILY
CLIENT-SERVER ROLES			
B11	Server side (of Two-party Application-Association)	c1	Yes
B12	Client side (of Two-party Application-Association)	---	
SCSMS SUPPORTED			
B21	SCSM: IEC 61850-8-1 used		Yes
B22	SCSM: IEC 61850-9-1 used		
B23	SCSM: IEC 61850-9-2 used		
B24	SCSM: other		
GENERIC SUBSTATION EVENT MODEL (GSE)			
B31	Publisher side	O	Yes
B32	Subscriber side	---	Yes
TRANSMISSION OF SAMPLED VALUE MODEL (SVC)			
B41	Publisher side	O	
B42	Subscriber side	---	



c1: shall be "M" if support for LOGICAL-DEVICE model has been declared

O: Optional

M: Mandatory

C.2.2 ACSI MODELS CONFORMANCE STATEMENT

SERVICES		SERVER/ PUBLISHER	UR-FAMILY
IF SERVER SIDE (B11) SUPPORTED			
M1	Logical device	c2	Yes
M2	Logical node	c3	Yes
M3	Data	c4	Yes
M4	Data set	c5	Yes
M5	Substitution	O	
M6	Setting group control	O	
REPORTING			
M7	Buffered report control	O	Yes
M7-1	sequence-number		
M7-2	report-time-stamp		
M7-3	reason-for-inclusion		
M7-4	data-set-name		
M7-5	data-reference		
M7-6	buffer-overflow		
M7-7	entryID		
M7-8	BufTm		
M7-9	IntgPd		
M7-10	GI		
M8	Unbuffered report control	O	Yes
M8-1	sequence-number		
M8-2	report-time-stamp		
M8-3	reason-for-inclusion		

C

SERVICES		SERVER/ PUBLISHER	UR-FAMILY
M8-4	data-set-name		
M8-5	data-reference		
M8-6	BufTm		
M8-7	IntgPd		
M8-8	GI		
	Logging	O	
M9	Log control	O	
M9-1	IntgPd		
M10	Log	O	
M11	Control	M	Yes
IF GSE (B31/32) IS SUPPORTED			
	GOOSE	O	Yes
M12-1	entryID		
M12-2	DataRefInc		
M13	GSSE	O	Yes
IF SVC (B41/B42) IS SUPPORTED			
M14	Multicast SVC	O	
M15	Unicast SVC	O	
M16	Time	M	Yes
M17	File transfer	O	Yes



c2: shall be "M" if support for LOGICAL-NODE model has been declared
c3: shall be "M" if support for DATA model has been declared
c4: shall be "M" if support for DATA-SET, Substitution, Report, Log Control, or Time models has been declared
c5: shall be "M" if support for Report, GSE, or SMV models has been declared
M: Mandatory

C.2.3 ACSI SERVICES CONFORMANCE STATEMENT

In the table below, the acronym AA refers to Application Associations (TP: Two Party / MC: Multicast). The c6 to c10 entries are defined in the notes following the table.

SERVICES		AA: TP/MC	SERVER/ PUBLISHER	UR FAMILY
SERVER (CLAUSE 6)				
S1	ServerDirectory	TP	M	Yes
APPLICATION ASSOCIATION (CLAUSE 7)				
S2	Associate		M	Yes
S3	Abort		M	Yes
S4	Release		M	Yes
LOGICAL DEVICE (CLAUSE 8)				
S5	LogicalDeviceDirectory	TP	M	Yes
LOGICAL NODE (CLAUSE 9)				
S6	LogicalNodeDirectory	TP	M	Yes
S7	GetAllDataValues	TP	M	Yes
DATA (CLAUSE 10)				
S8	GetDataValues	TP	M	Yes
S9	SetDataValues	TP	O	Yes
S10	GetDataDirectory	TP	M	Yes
S11	GetDataDefinition	TP	M	Yes

SERVICES		AA: TP/MC	SERVER/ PUBLISHER	UR FAMILY
DATA SET (CLAUSE 11)				
S12	GetDataSetValues	TP	M	Yes
S13	SetDataSetValues	TP	O	
S14	CreateDataSet	TP	O	
S15	DeleteDataSet	TP	O	
S16	GetDataSetDirectory	TP	O	Yes
SUBSTITUTION (CLAUSE 12)				
S17	SetDataValues	TP	M	
SETTING GROUP CONTROL (CLAUSE 13)				
S18	SelectActiveSG	TP	O	
S19	SelectEditSG	TP	O	
S20	SetSGValues	TP	O	
S21	ConfirmEditSGValues	TP	O	
S22	GetSGValues	TP	O	
S23	GetSGCBValues	TP	O	
REPORTING (CLAUSE 14)				
BUFFERED REPORT CONTROL BLOCK (BRCB)				
S24	Report	TP	c6	Yes
S24-1	data-change (dchg)			Yes
S24-2	qchg-change (qchg)			
S24-3	data-update (dupd)			
S25	GetBRCBValues	TP	c6	Yes
S26	SetBRCBValues	TP	c6	Yes
UNBUFFERED REPORT CONTROL BLOCK (URCB)				
S27	Report	TP	c6	Yes
S27-1	data-change (dchg)			Yes
S27-2	qchg-change (qchg)			
S27-3	data-update (dupd)			
S28	GetURCBValues	TP	c6	Yes
S29	SetURCBValues	TP	c6	Yes
LOGGING (CLAUSE 14)				
LOG CONTROL BLOCK				
S30	GetLCBValues	TP	M	
S31	SetLCBValues	TP	M	
LOG				
S32	QueryLogByTime	TP	M	
S33	QueryLogByEntry	TP	M	
S34	GetLogStatusValues	TP	M	
GENERIC SUBSTATION EVENT MODEL (GSE) (CLAUSE 14.3.5.3.4)				
GOOSE-CONTROL-BLOCK				
S35	SendGOOSEMessage	MC	c8	Yes
S36	GetReference	TP	c9	
S37	GetGOOSEElementNumber	TP	c9	
S38	GetGoCBValues	TP	O	Yes
S39	SetGoCBValues	TP	O	Yes
GSSE-CONTROL-BLOCK				
S40	SendGSSEMessage	MC	c8	Yes
S41	GetReference	TP	c9	

SERVICES		AA: TP/MC	SERVER/ PUBLISHER	UR FAMILY
S42	GetGSSEElementNumber	TP	c9	
S43	GetGsCBValues	TP	O	Yes
S44	SetGsCBValues	TP	O	Yes
TRANSMISSION OF SAMPLE VALUE MODEL (SVC) (CLAUSE 16)				
MULTICAST SVC				
S45	SendMSVMessage	MC	c10	
S46	GetMSVCBValues	TP	O	
S47	SetMSVCBValues	TP	O	
UNICAST SVC				
S48	SendUSVMessage	MC	c10	
S49	GetUSVCBValues	TP	O	
S50	SetUSVCBValues	TP	O	
CONTROL (CLAUSE 16.4.8)				
S51	Select		O	Yes
S52	SelectWithValue	TP	O	
S53	Cancel	TP	O	Yes
S54	Operate	TP	M	Yes
S55	Command-Termination	TP	O	
S56	TimeActivated-Operate	TP	O	
FILE TRANSFER (CLAUSE 20)				
S57	GetFile	TP	M	Yes
S58	SetFile	TP	O	
S59	DeleteFile	TP	O	
S60	GetFileAttributeValues	TP	M	Yes
TIME (CLAUSE 5.5)				
T1	Time resolution of internal clock (nearest negative power of 2 in seconds)			20
T2	Time accuracy of internal clock			
T3	supported TimeStamp resolution (nearest value of 2^{-n} in seconds, according to 5.5.3.7.3.3)			20



NOTE

- c6:** shall declare support for at least one (BRCB or UR CB)
c7: shall declare support for at least one (QueryLogByTime or QueryLogAfter)
c8: shall declare support for at least one (SendGOOSEMessage or SendGSSEMessage)
c9: shall declare support if TP association is available
c10: shall declare support for at least one (SendMSVMessage or SendUSVMessage)

C.3.1 LOGICAL NODES TABLE

The UR-series of relays supports IEC 61850 logical nodes as indicated in the following table. Note that the actual instantiation of each logical node is determined by the product order code. For example, the logical node "PDIS" (distance protection) is available only in the D60 Line Distance Relay.

NODES	UR-FAMILY
L: SYSTEM LOGICAL NODES	
LPHD: Physical device information	Yes
LLN0: Logical node zero	Yes
P: LOGICAL NODES FOR PROTECTION FUNCTIONS	
PDIF: Differential	---
PDIR: Direction comparison	---
PDIS: Distance	Yes
PDOP: Directional overpower	---
PDUP: Directional underpower	---
PFRC: Rate of change of frequency	---
PHAR: Harmonic restraint	---
PHIZ: Ground detector	---
PIOC: Instantaneous overcurrent	Yes
PMRI: Motor restart inhibition	---
PMSS: Motor starting time supervision	---
POPF: Over power factor	---
PPAM: Phase angle measuring	---
PSCH: Protection scheme	---
PSDE: Sensitive directional earth fault	---
PTEF: Transient earth fault	---
PTOC: Time overcurrent	Yes
PTOF: Overfrequency	---
PTOV: Overvoltage	Yes
PTRC: Protection trip conditioning	Yes
PTTR: Thermal overload	Yes
PTUC: Undercurrent	---
PTUV: Undervoltage	Yes
PUPF: Underpower factor	---
PTUF: Underfrequency	---
PVOC: Voltage controlled time overcurrent	---
PVPH: Volts per Hz	---
PZSU: Zero speed or underspeed	---
R: LOGICAL NODES FOR PROTECTION RELATED FUNCTIONS	
RDRE: Disturbance recorder function	---
RADR: Disturbance recorder channel analogue	---
RBDR: Disturbance recorder channel binary	---
RDRS: Disturbance record handling	---
RBRF: Breaker failure	Yes
RDIR: Directional element	---
RFLO: Fault locator	Yes
RPSB: Power swing detection/blocking	Yes
RREC: Autoreclosing	Yes

NODES	UR-FAMILY
RSYN: Synchronism-check or synchronizing	---
C: LOGICAL NODES FOR CONTROL	
CALH: Alarm handling	---
CCGR: Cooling group control	---
CILO: Interlocking	---
CPOW: Point-on-wave switching	---
CSWI: Switch controller	---
G: LOGICAL NODES FOR GENERIC REFERENCES	
GAPC: Generic automatic process control	---
GGIO: Generic process I/O	Yes
GSAL: Generic security application	---
I: LOGICAL NODES FOR INTERFACING AND ARCHIVING	
IARC: Archiving	---
IHMI: Human machine interface	---
ITCI: Telecontrol interface	---
ITMI: Telemonitoring interface	---
A: LOGICAL NODES FOR AUTOMATIC CONTROL	
ANCR: Neutral current regulator	---
ARCO: Reactive power control	---
ATCC: Automatic tap changer controller	---
AVCO: Voltage control	---
M: LOGICAL NODES FOR METERING AND MEASUREMENT	
MDIF: Differential measurements	---
MHAI: Harmonics or interharmonics	---
MHAN: Non phase related harmonics or interharmonic	---
MMTR: Metering	---
MMXN: Non phase related measurement	Yes
MMXU: Measurement	Yes
MSQI: Sequence and imbalance	---
MSTA: Metering statistics	---
S: LOGICAL NODES FOR SENSORS AND MONITORING	
SARC: Monitoring and diagnostics for arcs	---
SIMG: Insulation medium supervision (gas)	---
SIML: Insulation medium supervision (liquid)	---
SPDC: Monitoring and diagnostics for partial discharges	---
X: LOGICAL NODES FOR SWITCHGEAR	
XCBR: Circuit breaker	Yes
XSWI: Circuit switch	---
T: LOGICAL NODES FOR INSTRUMENT TRANSFORMERS	
TCTR: Current transformer	---
TVTR: Voltage transformer	---

NODES	UR-FAMILY
Y: LOGICAL NODES FOR POWER TRANSFORMERS	
YEFN: Earth fault neutralizer (Peterson coil)	---
YLTC: Tap changer	---
YPSH: Power shunt	---
YPTR: Power transformer	---
Z: LOGICAL NODES FOR FURTHER POWER SYSTEM EQUIPMENT	
ZAXN: Auxiliary network	---
ZBAT: Battery	---
ZBSH: Bushing	---
ZCAB: Power cable	---
ZCAP: Capacitor bank	---
ZCON: Converter	---
ZGEN: Generator	---
ZGIL: Gas insulated line	---
ZLIN: Power overhead line	---
ZMOT: Motor	---
ZREA: Reactor	---
ZRRC: Rotating reactive component	---
ZSAR: Surge arrestor	---
ZTCF: Thyristor controlled frequency converter	---
ZTRC: Thyristor controlled reactive component	---

C

D.1.1 INTEROPERABILITY DOCUMENT

This document is adapted from the IEC 60870-5-104 standard. For this section the boxes indicate the following: – used in standard direction; – not used; – cannot be selected in IEC 60870-5-104 standard.

1. SYSTEM OR DEVICE:

- System Definition
- Controlling Station Definition (Master)
- Controlled Station Definition (Slave)**

2. NETWORK CONFIGURATION:

- Point to Point
- Multipoint
- Multiple Point to Point
- Multipoint Star

3. PHYSICAL LAYER

Transmission Speed (control direction):

Unbalanced Interchange Circuit V.24/V.28 Standard:	Unbalanced Interchange Circuit V.24/V.28 Recommended if >1200 bits/s:	Balanced Interchange Circuit X.24/X.27:
<ul style="list-style-type: none"> <input type="checkbox"/> 100 bits/sec. <input type="checkbox"/> 200 bits/sec. <input type="checkbox"/> 300 bits/sec. <input type="checkbox"/> 600 bits/sec. <input type="checkbox"/> 1200 bits/sec. 	<ul style="list-style-type: none"> <input type="checkbox"/> 2400 bits/sec. <input type="checkbox"/> 4800 bits/sec. <input type="checkbox"/> 9600 bits/sec. 	<ul style="list-style-type: none"> <input type="checkbox"/> 2400 bits/sec. <input type="checkbox"/> 4800 bits/sec. <input type="checkbox"/> 9600 bits/sec. <input type="checkbox"/> 19200 bits/sec. <input type="checkbox"/> 38400 bits/sec. <input type="checkbox"/> 56000 bits/sec. <input type="checkbox"/> 64000 bits/sec.

Transmission Speed (monitor direction):

Unbalanced Interchange Circuit V.24/V.28 Standard:	Unbalanced Interchange Circuit V.24/V.28 Recommended if >1200 bits/s:	Balanced Interchange Circuit X.24/X.27:
<ul style="list-style-type: none"> <input type="checkbox"/> 100 bits/sec. <input type="checkbox"/> 200 bits/sec. <input type="checkbox"/> 300 bits/sec. <input type="checkbox"/> 600 bits/sec. <input type="checkbox"/> 1200 bits/sec. 	<ul style="list-style-type: none"> <input type="checkbox"/> 2400 bits/sec. <input type="checkbox"/> 4800 bits/sec. <input type="checkbox"/> 9600 bits/sec. 	<ul style="list-style-type: none"> <input type="checkbox"/> 2400 bits/sec. <input type="checkbox"/> 4800 bits/sec. <input type="checkbox"/> 9600 bits/sec. <input type="checkbox"/> 19200 bits/sec. <input type="checkbox"/> 38400 bits/sec. <input type="checkbox"/> 56000 bits/sec. <input type="checkbox"/> 64000 bits/sec.

4. LINK LAYER

Link Transmission Procedure:	Address Field of the Link:
<ul style="list-style-type: none"> <input type="checkbox"/> Balanced Transmission <input type="checkbox"/> Unbalanced Transmission 	<ul style="list-style-type: none"> <input type="checkbox"/> Not Present (Balanced Transmission Only) <input type="checkbox"/> One Octet <input type="checkbox"/> Two Octets <input type="checkbox"/> Structured <input type="checkbox"/> Unstructured
<p>Frame Length (maximum length, number of octets): Not selectable in companion IEC 60870-5-104 standard</p>	



When using an unbalanced link layer, the following ADSU types are returned in class 2 messages (low priority) with the indicated causes of transmission:

- The standard assignment of ADSUs to class 2 messages is used as follows:
- A special assignment of ADSUs to class 2 messages is used as follows:

5. APPLICATION LAYER

Transmission Mode for Application Data:

Mode 1 (least significant octet first), as defined in Clause 4.10 of IEC 60870-5-4, is used exclusively in this companion standard.

Common Address of ADSU:

- One Octet
- Two Octets

Information Object Address:

- One Octet
- Structured
- Two Octets
- Unstructured
- Three Octets

Cause of Transmission:

- One Octet
- Two Octets (with originator address). Originator address is set to zero if not used.

Maximum Length of APDU: 253 (the maximum length may be reduced by the system).

Selection of standard ASDUs:

For the following lists, the boxes indicate the following: – used in standard direction; – not used; – cannot be selected in IEC 60870-5-104 standard.

Process information in monitor direction

<input checked="" type="checkbox"/> <1> := Single-point information	M_SP_NA_1
<input type="checkbox"/> <2> := Single-point information with time tag	M_SP_TA_1
<input type="checkbox"/> <3> := Double-point information	M_DP_NA_1
<input type="checkbox"/> <4> := Double-point information with time tag	M_DP_TA_1
<input type="checkbox"/> <5> := Step position information	M_ST_NA_1
<input type="checkbox"/> <6> := Step position information with time tag	M_ST_TA_1
<input type="checkbox"/> <7> := Bitstring of 32 bits	M_BO_NA_1
<input type="checkbox"/> <8> := Bitstring of 32 bits with time tag	M_BO_TA_1
<input type="checkbox"/> <9> := Measured value, normalized value	M_ME_NA_1
<input type="checkbox"/> <10> := Measured value, normalized value with time tag	M_ME_TA_1
<input type="checkbox"/> <11> := Measured value, scaled value	M_ME_NB_1
<input type="checkbox"/> <12> := Measured value, scaled value with time tag	M_ME_TB_1
<input checked="" type="checkbox"/> <13> := Measured value, short floating point value	M_ME_NC_1
<input type="checkbox"/> <14> := Measured value, short floating point value with time tag	M_ME_TC_1
<input checked="" type="checkbox"/> <15> := Integrated totals	M_IT_NA_1
<input type="checkbox"/> <16> := Integrated totals with time tag	M_IT_TA_1
<input type="checkbox"/> <17> := Event of protection equipment with time tag	M_EP_TA_1
<input type="checkbox"/> <18> := Packed start events of protection equipment with time tag	M_EP_TB_1
<input type="checkbox"/> <19> := Packed output circuit information of protection equipment with time tag	M_EP_TC_1
<input type="checkbox"/> <20> := Packed single-point information with status change detection	M_SP_NA_1

<input type="checkbox"/> <21> := Measured value, normalized value without quantity descriptor	M_ME_ND_1
<input checked="" type="checkbox"/> <30> := Single-point information with time tag CP56Time2a	M_SP_TB_1
<input type="checkbox"/> <31> := Double-point information with time tag CP56Time2a	M_DP_TB_1
<input type="checkbox"/> <32> := Step position information with time tag CP56Time2a	M_ST_TB_1
<input type="checkbox"/> <33> := Bitstring of 32 bits with time tag CP56Time2a	M_BO_TB_1
<input type="checkbox"/> <34> := Measured value, normalized value with time tag CP56Time2a	M_ME_TD_1
<input type="checkbox"/> <35> := Measured value, scaled value with time tag CP56Time2a	M_ME_TE_1
<input type="checkbox"/> <36> := Measured value, short floating point value with time tag CP56Time2a	M_ME_TF_1
<input checked="" type="checkbox"/> <37> := Integrated totals with time tag CP56Time2a	M_IT_TB_1
<input type="checkbox"/> <38> := Event of protection equipment with time tag CP56Time2a	M_EP_TD_1
<input type="checkbox"/> <39> := Packed start events of protection equipment with time tag CP56Time2a	M_EP_TE_1
<input type="checkbox"/> <40> := Packed output circuit information of protection equipment with time tag CP56Time2a	M_EP_TF_1

Either the ASDUs of the set <2>, <4>, <6>, <8>, <10>, <12>, <14>, <16>, <17>, <18>, and <19> or of the set <30> to <40> are used.

Process information in control direction

<input checked="" type="checkbox"/> <45> := Single command	C_SC_NA_1
<input type="checkbox"/> <46> := Double command	C_DC_NA_1
<input type="checkbox"/> <47> := Regulating step command	C_RC_NA_1
<input type="checkbox"/> <48> := Set point command, normalized value	C_SE_NA_1
<input type="checkbox"/> <49> := Set point command, scaled value	C_SE_NB_1
<input type="checkbox"/> <50> := Set point command, short floating point value	C_SE_NC_1
<input type="checkbox"/> <51> := Bitstring of 32 bits	C_BO_NA_1
<input checked="" type="checkbox"/> <58> := Single command with time tag CP56Time2a	C_SC_TA_1
<input type="checkbox"/> <59> := Double command with time tag CP56Time2a	C_DC_TA_1
<input type="checkbox"/> <60> := Regulating step command with time tag CP56Time2a	C_RC_TA_1
<input type="checkbox"/> <61> := Set point command, normalized value with time tag CP56Time2a	C_SE_TA_1
<input type="checkbox"/> <62> := Set point command, scaled value with time tag CP56Time2a	C_SE_TB_1
<input type="checkbox"/> <63> := Set point command, short floating point value with time tag CP56Time2a	C_SE_TC_1
<input type="checkbox"/> <64> := Bitstring of 32 bits with time tag CP56Time2a	C_BO_TA_1

Either the ASDUs of the set <45> to <51> or of the set <58> to <64> are used.

System information in monitor direction

<input checked="" type="checkbox"/> <70> := End of initialization	M_EI_NA_1
---	-----------

System information in control direction

<input checked="" type="checkbox"/> <100> := Interrogation command	C_IC_NA_1
<input checked="" type="checkbox"/> <101> := Counter interrogation command	C_CI_NA_1
<input checked="" type="checkbox"/> <102> := Read command	C_RD_NA_1
<input checked="" type="checkbox"/> <103> := Clock synchronization command (see Clause 7.6 in standard)	C_CS_NA_1
<input checked="" type="checkbox"/> <104> := Test command	C_TS_NA_1
<input checked="" type="checkbox"/> <105> := Reset process command	C_RP_NA_1
<input checked="" type="checkbox"/> <106> := Delay acquisition command	C_CD_NA_1
<input checked="" type="checkbox"/> <107> := Test command with time tag CP56Time2a	C_TS_TA_1

Parameter in control direction

- <110> := Parameter of measured value, normalized value PE_ME_NA_1
- <111> := Parameter of measured value, scaled value PE_ME_NB_1
- <112> := Parameter of measured value, short floating point value PE_ME_NC_1
- <113> := Parameter activation PE_AC_NA_1

File transfer

- <120> := File Ready F_FR_NA_1
- <121> := Section Ready F_SR_NA_1
- <122> := Call directory, select file, call file, call section F_SC_NA_1
- <123> := Last section, last segment F_LS_NA_1
- <124> := Ack file, ack section F_AF_NA_1
- <125> := Segment F_SG_NA_1
- <126> := Directory (blank or X, available only in monitor [standard] direction) C_CD_NA_1

Type identifier and cause of transmission assignments
(station-specific parameters)

In the following table:

- Shaded boxes are not required.
- Black boxes are not permitted in this companion standard.
- Blank boxes indicate functions or ASDU not used.
- 'X' if only used in the standard direction

TYPE IDENTIFICATION		CAUSE OF TRANSMISSION																		
		PERIODIC, CYCLIC	BACKGROUND SCAN	SPONTANEOUS	INITIALIZED	REQUEST OR REQUESTED	ACTIVATION	ACTIVATION CONFIRMATION	DEACTIVATION	DEACTIVATION CONFIRMATION	ACTIVATION TERMINATION	RETURN INFO CAUSED BY LOCAL CMD	FILE TRANSFER	INTERROGATED BY GROUP <NUMBER>	REQUEST BY GROUP <N> COUNTER REQ	UNKNOWN TYPE IDENTIFICATION	UNKNOWN CAUSE OF TRANSMISSION	UNKNOWN COMMON ADDRESS OF ADSU	UNKNOWN INFORMATION OBJECT ADDR	UNKNOWN INFORMATION OBJECT ADDR
NO.	MNEMONIC	1	2	3	4	5	6	7	8	9	10	11	12	13	20 to 36	37 to 41	44	45	46	47
<1>	M_SP_NA_1			X		X						X	X		X					
<2>	M_SP_TA_1																			
<3>	M_DP_NA_1																			
<4>	M_DP_TA_1																			
<5>	M_ST_NA_1																			
<6>	M_ST_TA_1																			
<7>	M_BO_NA_1																			
<8>	M_BO_TA_1																			

D

TYPE IDENTIFICATION		CAUSE OF TRANSMISSION																			
		PERIODIC, CYCLIC	BACKGROUND SCAN	SPONTANEOUS	INITIALIZED	REQUEST OR REQUESTED	ACTIVATION	ACTIVATION CONFIRMATION	DEACTIVATION	DEACTIVATION CONFIRMATION	ACTIVATION TERMINATION	RETURN INFO CAUSED BY LOCAL CMD	FILE TRANSFER	INTERROGATED BY GROUP <NUMBER>	REQUEST BY GROUP <N> COUNTER REQ	UNKNOWN TYPE IDENTIFICATION	UNKNOWN CAUSE OF TRANSMISSION	UNKNOWN COMMON ADDRESS OF ADSU	UNKNOWN INFORMATION OBJECT ADDR	UNKNOWN INFORMATION OBJECT ADDR	
NO.	MNEMONIC	1	2	3	4	5	6	7	8	9	10	11	12	13	20 to 36	37 to 41	44	45	46	47	
<9>	M_ME_NA_1																				
<10>	M_ME_TA_1																				
<11>	M_ME_NB_1																				
<12>	M_ME_TB_1																				
<13>	M_ME_NC_1	X		X		X									X						
<14>	M_ME_TC_1																				
<15>	M_IT_NA_1			X													X				
<16>	M_IT_TA_1																				
<17>	M_EP_TA_1																				
<18>	M_EP_TB_1																				
<19>	M_EP_TC_1																				
<20>	M_PS_NA_1																				
<21>	M_ME_ND_1																				
<30>	M_SP_TB_1			X								X	X								
<31>	M_DP_TB_1																				
<32>	M_ST_TB_1																				
<33>	M_BO_TB_1																				
<34>	M_ME_TD_1																				
<35>	M_ME_TE_1																				
<36>	M_ME_TF_1																				
<37>	M_IT_TB_1			X													X				
<38>	M_EP_TD_1																				
<39>	M_EP_TE_1																				
<40>	M_EP_TF_1																				
<45>	C_SC_NA_1						X	X	X	X	X										
<46>	C_DC_NA_1																				
<47>	C_RC_NA_1																				
<48>	C_SE_NA_1																				
<49>	C_SE_NB_1																				

D

D

TYPE IDENTIFICATION		CAUSE OF TRANSMISSION																			
		PERIODIC, CYCLIC	BACKGROUND SCAN	SPONTANEOUS	INITIALIZED	REQUEST OR REQUESTED	ACTIVATION	ACTIVATION CONFIRMATION	DEACTIVATION	DEACTIVATION CONFIRMATION	ACTIVATION TERMINATION	RETURN INFO CAUSED BY LOCAL CMD	FILE TRANSFER	INTERROGATED BY GROUP <NUMBER>	REQUEST BY GROUP <N> COUNTER REQ	UNKNOWN TYPE IDENTIFICATION	UNKNOWN CAUSE OF TRANSMISSION	UNKNOWN COMMON ADDRESS OF ADSU	UNKNOWN INFORMATION OBJECT ADDR	UNKNOWN INFORMATION OBJECT ADDR	
NO.	MNEMONIC	1	2	3	4	5	6	7	8	9	10	11	12	13	20 to 36	37 to 41	44	45	46	47	
<50>	C_SE_NC_1																				
<51>	C_BO_NA_1																				
<58>	C_SC_TA_1						X	X	X	X	X										
<59>	C_DC_TA_1																				
<60>	C_RC_TA_1																				
<61>	C_SE_TA_1																				
<62>	C_SE_TB_1																				
<63>	C_SE_TC_1																				
<64>	C_BO_TA_1																				
<70>	M_EI_NA_1*)				X																
<100>	C_IC_NA_1						X	X	X	X	X										
<101>	C_CI_NA_1						X	X			X										
<102>	C_RD_NA_1					X															
<103>	C_CS_NA_1			X			X	X													
<104>	C_TS_NA_1																				
<105>	C_RP_NA_1						X	X													
<106>	C_CD_NA_1																				
<107>	C_TS_TA_1																				
<110>	P_ME_NA_1																				
<111>	P_ME_NB_1																				
<112>	P_ME_NC_1						X	X							X						
<113>	P_AC_NA_1																				
<120>	F_FR_NA_1																				
<121>	F_SR_NA_1																				
<122>	F_SC_NA_1																				
<123>	F_LS_NA_1																				
<124>	F_AF_NA_1																				
<125>	F_SG_NA_1																				
<126>	F_DR_TA_1*)																				

6. BASIC APPLICATION FUNCTIONS

Station Initialization:

- Remote initialization

Cyclic Data Transmission:

- Cyclic data transmission

Read Procedure:

- Read procedure

Spontaneous Transmission:

- Spontaneous transmission

Double transmission of information objects with cause of transmission spontaneous:

The following type identifications may be transmitted in succession caused by a single status change of an information object. The particular information object addresses for which double transmission is enabled are defined in a project-specific list.

- Single point information: M_SP_NA_1, M_SP_TA_1, M_SP_TB_1, and M_PS_NA_1
- Double point information: M_DP_NA_1, M_DP_TA_1, and M_DP_TB_1
- Step position information: M_ST_NA_1, M_ST_TA_1, and M_ST_TB_1
- Bitstring of 32 bits: M_BO_NA_1, M_BO_TA_1, and M_BO_TB_1 (if defined for a specific project)
- Measured value, normalized value: M_ME_NA_1, M_ME_TA_1, M_ME_ND_1, and M_ME_TD_1
- Measured value, scaled value: M_ME_NB_1, M_ME_TB_1, and M_ME_TE_1
- Measured value, short floating point number: M_ME_NC_1, M_ME_TC_1, and M_ME_TF_1

Station interrogation:

- Global
- Group 1 Group 5 Group 9 Group 13
- Group 2 Group 6 Group 10 Group 14
- Group 3 Group 7 Group 11 Group 15
- Group 4 Group 8 Group 12 Group 16

Clock synchronization:

- Clock synchronization (optional, see Clause 7.6)

Command transmission:

- Direct command transmission
- Direct setpoint command transmission
- Select and execute command
- Select and execute setpoint command
- C_SE ACTTERM used
- No additional definition
- Short pulse duration (duration determined by a system parameter in the outstation)
- Long pulse duration (duration determined by a system parameter in the outstation)
- Persistent output

- Supervision of maximum delay in command direction of commands and setpoint commands

Maximum allowable delay of commands and setpoint commands: **10 s**

Transmission of integrated totals:

- Mode A: Local freeze with spontaneous transmission
- Mode B: Local freeze with counter interrogation
- Mode C: Freeze and transmit by counter-interrogation commands
- Mode D: Freeze by counter-interrogation command, frozen values reported simultaneously

- Counter read
- Counter freeze without reset
- Counter freeze with reset
- Counter reset

- General request counter
- Request counter group 1
- Request counter group 2
- Request counter group 3
- Request counter group 4

Parameter loading:

- Threshold value
- Smoothing factor
- Low limit for transmission of measured values
- High limit for transmission of measured values

Parameter activation:

- Activation/deactivation of persistent cyclic or periodic transmission of the addressed object

Test procedure:

- Test procedure

File transfer:

File transfer in monitor direction:

- Transparent file
- Transmission of disturbance data of protection equipment
- Transmission of sequences of events
- Transmission of sequences of recorded analog values

File transfer in control direction:

- Transparent file

Background scan:

- Background scan

Acquisition of transmission delay:

- Acquisition of transmission delay

Definition of time outs:

PARAMETER	DEFAULT VALUE	REMARKS	SELECTED VALUE
t_0	30 s	Timeout of connection establishment	120 s
t_1	15 s	Timeout of send or test APDUs	15 s
t_2	10 s	Timeout for acknowledgements in case of no data messages $t_2 < t_1$	10 s
t_3	20 s	Timeout for sending test frames in case of a long idle state	20 s

Maximum range of values for all time outs: 1 to 255 s, accuracy 1 s

Maximum number of outstanding I-format APDUs k and latest acknowledge APDUs (w):

PARAMETER	DEFAULT VALUE	REMARKS	SELECTED VALUE
k	12 APDUs	Maximum difference receive sequence number to send state variable	12 APDUs
w	8 APDUs	Latest acknowledge after receiving w I-format APDUs	8 APDUs

Maximum range of values k : 1 to 32767 ($2^{15} - 1$) APDUs, accuracy 1 APDU

Maximum range of values w : 1 to 32767 APDUs, accuracy 1 APDU

Recommendation: w should not exceed two-thirds of k .

Portnumber:

PARAMETER	VALUE	REMARKS
Portnumber	2404	In all cases

RFC 2200 suite:

RFC 2200 is an official Internet Standard which describes the state of standardization of protocols used in the Internet as determined by the Internet Architecture Board (IAB). It offers a broad spectrum of actual standards used in the Internet. The suitable selection of documents from RFC 2200 defined in this standard for given projects has to be chosen by the user of this standard.

- Ethernet 802.3
- Serial X.21 interface
- Other selection(s) from RFC 2200 (list below if selected)

D.1.2 POINT LIST

The IEC 60870-5-104 data points are configured through the **SETTINGS** ⇒ **PRODUCT SETUP** ⇒ **COMMUNICATIONS** ⇒ **DNP / IEC104 POINT LISTS** menu. Refer to the *Communications* section of Chapter 5 for additional details.

D

E.1.1 DNP V3.00 DEVICE PROFILE

The following table provides a 'Device Profile Document' in the standard format defined in the DNP 3.0 Subset Definitions Document.

Table E-1: DNP V3.00 DEVICE PROFILE (Sheet 1 of 3)

(Also see the IMPLEMENTATION TABLE in the following section)	
Vendor Name: General Electric Multilin	
Device Name: UR Series Relay	
Highest DNP Level Supported: For Requests: Level 2 For Responses: Level 2	Device Function: <input type="checkbox"/> Master <input checked="" type="checkbox"/> Slave
Notable objects, functions, and/or qualifiers supported in addition to the Highest DNP Levels Supported (the complete list is described in the attached table): <ul style="list-style-type: none"> Binary Inputs (Object 1) Binary Input Changes (Object 2) Binary Outputs (Object 10) Binary Counters (Object 20) Frozen Counters (Object 21) Counter Change Event (Object 22) Frozen Counter Event (Object 23) Analog Inputs (Object 30) Analog Input Changes (Object 32) Analog Deadbands (Object 34) File Transfer (Object 70) 	
Maximum Data Link Frame Size (octets): Transmitted: 292 Received: 292	Maximum Application Fragment Size (octets): Transmitted: 240 Received: 2048
Maximum Data Link Re-tries: <input type="checkbox"/> None <input checked="" type="checkbox"/> Fixed at 2 <input type="checkbox"/> Configurable	Maximum Application Layer Re-tries: <input checked="" type="checkbox"/> None <input type="checkbox"/> Configurable
Requires Data Link Layer Confirmation: <input checked="" type="checkbox"/> Never <input type="checkbox"/> Always <input type="checkbox"/> Sometimes <input type="checkbox"/> Configurable	



Table E-1: DNP V3.00 DEVICE PROFILE (Sheet 2 of 3)

Requires Application Layer Confirmation:				
<input type="checkbox"/>	Never			
<input type="checkbox"/>	Always			
<input checked="" type="checkbox"/>	When reporting Event Data			
<input checked="" type="checkbox"/>	When sending multi-fragment responses			
<input type="checkbox"/>	Sometimes			
<input type="checkbox"/>	Configurable			
Timeouts while waiting for:				
Data Link Confirm:	<input type="checkbox"/> None	<input checked="" type="checkbox"/> Fixed at 3 s	<input type="checkbox"/> Variable	<input type="checkbox"/> Configurable
Complete Appl. Fragment:	<input checked="" type="checkbox"/> None	<input type="checkbox"/> Fixed at ____	<input type="checkbox"/> Variable	<input type="checkbox"/> Configurable
Application Confirm:	<input type="checkbox"/> None	<input checked="" type="checkbox"/> Fixed at 4 s	<input type="checkbox"/> Variable	<input type="checkbox"/> Configurable
Complete Appl. Response:	<input checked="" type="checkbox"/> None	<input type="checkbox"/> Fixed at ____	<input type="checkbox"/> Variable	<input type="checkbox"/> Configurable
Others:				
Transmission Delay:	No intentional delay			
Inter-character Timeout:	50 ms			
Need Time Delay:	Configurable (default = 24 hrs.)			
Select/Operate Arm Timeout:	10 s			
Binary input change scanning period:	8 times per power system cycle			
Packed binary change process period:	1 s			
Analog input change scanning period:	500 ms			
Counter change scanning period:	500 ms			
Frozen counter event scanning period:	500 ms			
Unsolicited response notification delay:	500 ms			
Unsolicited response retry delay	configurable 0 to 60 sec.			
Sends/Executes Control Operations:				
WRITE Binary Outputs	<input checked="" type="checkbox"/> Never	<input type="checkbox"/> Always	<input type="checkbox"/> Sometimes	<input type="checkbox"/> Configurable
SELECT/OPERATE	<input type="checkbox"/> Never	<input checked="" type="checkbox"/> Always	<input type="checkbox"/> Sometimes	<input type="checkbox"/> Configurable
DIRECT OPERATE	<input type="checkbox"/> Never	<input checked="" type="checkbox"/> Always	<input type="checkbox"/> Sometimes	<input type="checkbox"/> Configurable
DIRECT OPERATE – NO ACK	<input type="checkbox"/> Never	<input checked="" type="checkbox"/> Always	<input type="checkbox"/> Sometimes	<input type="checkbox"/> Configurable
Count > 1	<input checked="" type="checkbox"/> Never	<input type="checkbox"/> Always	<input type="checkbox"/> Sometimes	<input type="checkbox"/> Configurable
Pulse On	<input type="checkbox"/> Never	<input type="checkbox"/> Always	<input checked="" type="checkbox"/> Sometimes	<input type="checkbox"/> Configurable
Pulse Off	<input type="checkbox"/> Never	<input type="checkbox"/> Always	<input checked="" type="checkbox"/> Sometimes	<input type="checkbox"/> Configurable
Latch On	<input type="checkbox"/> Never	<input type="checkbox"/> Always	<input checked="" type="checkbox"/> Sometimes	<input type="checkbox"/> Configurable
Latch Off	<input type="checkbox"/> Never	<input type="checkbox"/> Always	<input checked="" type="checkbox"/> Sometimes	<input type="checkbox"/> Configurable
Queue	<input checked="" type="checkbox"/> Never	<input type="checkbox"/> Always	<input type="checkbox"/> Sometimes	<input type="checkbox"/> Configurable
Clear Queue	<input checked="" type="checkbox"/> Never	<input type="checkbox"/> Always	<input type="checkbox"/> Sometimes	<input type="checkbox"/> Configurable
Explanation of ‘Sometimes’: Object 12 points are mapped to UR Virtual Inputs. The persistence of Virtual Inputs is determined by the VIRTUAL INPUT X TYPE settings. Both “Pulse On” and “Latch On” operations perform the same function in the UR; that is, the appropriate Virtual Input is put into the “On” state. If the Virtual Input is set to “Self-Reset”, it will reset after one pass of FlexLogic™. The On/Off times and Count value are ignored. “Pulse Off” and “Latch Off” operations put the appropriate Virtual Input into the “Off” state. “Trip” and “Close” operations both put the appropriate Virtual Input into the “On” state.				

E

Table E-1: DNP V3.00 DEVICE PROFILE (Sheet 3 of 3)

<p>Reports Binary Input Change Events when no specific variation requested:</p> <ul style="list-style-type: none"> <input type="checkbox"/> Never <input checked="" type="checkbox"/> Only time-tagged <input type="checkbox"/> Only non-time-tagged <input type="checkbox"/> Configurable 	<p>Reports time-tagged Binary Input Change Events when no specific variation requested:</p> <ul style="list-style-type: none"> <input type="checkbox"/> Never <input checked="" type="checkbox"/> Binary Input Change With Time <input type="checkbox"/> Binary Input Change With Relative Time <input type="checkbox"/> Configurable (attach explanation)
<p>Sends Unsolicited Responses:</p> <ul style="list-style-type: none"> <input type="checkbox"/> Never <input checked="" type="checkbox"/> Configurable <input type="checkbox"/> Only certain objects <input type="checkbox"/> Sometimes (attach explanation) <input checked="" type="checkbox"/> ENABLE/DISABLE unsolicited Function codes supported 	<p>Sends Static Data in Unsolicited Responses:</p> <ul style="list-style-type: none"> <input checked="" type="checkbox"/> Never <input type="checkbox"/> When Device Restarts <input type="checkbox"/> When Status Flags Change <p>No other options are permitted.</p>
<p>Default Counter Object/Variation:</p> <ul style="list-style-type: none"> <input type="checkbox"/> No Counters Reported <input type="checkbox"/> Configurable (attach explanation) <input checked="" type="checkbox"/> Default Object: 20 <input checked="" type="checkbox"/> Default Variation: 1 <input checked="" type="checkbox"/> Point-by-point list attached 	<p>Counters Roll Over at:</p> <ul style="list-style-type: none"> <input type="checkbox"/> No Counters Reported <input type="checkbox"/> Configurable (attach explanation) <input checked="" type="checkbox"/> 16 Bits (Counter 8) <input checked="" type="checkbox"/> 32 Bits (Counters 0 to 7, 9) <input type="checkbox"/> Other Value: _____ <input checked="" type="checkbox"/> Point-by-point list attached
<p>Sends Multi-Fragment Responses:</p> <ul style="list-style-type: none"> <input checked="" type="checkbox"/> Yes <input type="checkbox"/> No 	



E.1.2 IMPLEMENTATION TABLE

The following table identifies the variations, function codes, and qualifiers supported by the T60 in both request messages and in response messages. For static (non-change-event) objects, requests sent with qualifiers 00, 01, 06, 07, or 08, will be responded with qualifiers 00 or 01. Static object requests sent with qualifiers 17 or 28 will be responded with qualifiers 17 or 28. For change-event objects, qualifiers 17 or 28 are always responded.

Table E-2: IMPLEMENTATION TABLE (Sheet 1 of 4)

OBJECT			REQUEST		RESPONSE	
OBJECT NO.	VARIATION NO.	DESCRIPTION	FUNCTION CODES (DEC)	QUALIFIER CODES (HEX)	FUNCTION CODES (DEC)	QUALIFIER CODES (HEX)
1	0	Binary Input (Variation 0 is used to request default variation)	1 (read) 22 (assign class)	00, 01 (start-stop) 06 (no range, or all) 07, 08 (limited quantity) 17, 28 (index)		
	1	Binary Input	1 (read) 22 (assign class)	00, 01 (start-stop) 06 (no range, or all) 07, 08 (limited quantity) 17, 28 (index)	129 (response)	00, 01 (start-stop) 17, 28 (index) (see Note 2)
	2	Binary Input with Status	1 (read) 22 (assign class)	00, 01 (start-stop) 06 (no range, or all) 07, 08 (limited quantity) 17, 28 (index)	129 (response)	00, 01 (start-stop) 17, 28 (index) (see Note 2)
2	0	Binary Input Change (Variation 0 is used to request default variation)	1 (read)	06 (no range, or all) 07, 08 (limited quantity)		
	1	Binary Input Change without Time	1 (read)	06 (no range, or all) 07, 08 (limited quantity)	129 (response) 130 (unsol. resp.)	17, 28 (index)
	2	Binary Input Change with Time	1 (read)	06 (no range, or all) 07, 08 (limited quantity)	129 (response) 130 (unsol. resp.)	17, 28 (index)
	3 (parse only)	Binary Input Change with Relative Time	1 (read)	06 (no range, or all) 07, 08 (limited quantity)		
10	0	Binary Output Status (Variation 0 is used to request default variation)	1 (read)	00, 01 (start-stop) 06 (no range, or all) 07, 08 (limited quantity) 17, 28 (index)		
	2	Binary Output Status	1 (read)	00, 01 (start-stop) 06 (no range, or all) 07, 08 (limited quantity) 17, 28 (index)	129 (response)	00, 01 (start-stop) 17, 28 (index) (see Note 2)
12	1	Control Relay Output Block	3 (select) 4 (operate) 5 (direct op) 6 (dir. op, noack)	00, 01 (start-stop) 07, 08 (limited quantity) 17, 28 (index)	129 (response)	echo of request
20	0	Binary Counter (Variation 0 is used to request default variation)	1 (read) 7 (freeze) 8 (freeze noack) 9 (freeze clear) 10 (frz. cl. noack) 22 (assign class)	00, 01 (start-stop) 06 (no range, or all) 07, 08 (limited quantity) 17, 28 (index)		
	1	32-Bit Binary Counter	1 (read) 7 (freeze) 8 (freeze noack) 9 (freeze clear) 10 (frz. cl. noack) 22 (assign class)	00, 01 (start-stop) 06 (no range, or all) 07, 08 (limited quantity) 17, 28 (index)	129 (response)	00, 01 (start-stop) 17, 28 (index) (see Note 2)

Note 1: A default variation refers to the variation responded when variation 0 is requested and/or in class 0, 1, 2, or 3 scans. The default variations for object types 1, 2, 20, 21, 22, 23, 30, and 32 are selected via relay settings. Refer to the *Communications* section in Chapter 5 for details. This optimizes the class 0 poll data size.

Note 2: For static (non-change-event) objects, qualifiers 17 or 28 are only responded when a request is sent with qualifiers 17 or 28, respectively. Otherwise, static object requests sent with qualifiers 00, 01, 06, 07, or 08, will be responded with qualifiers 00 or 01 (for change-event objects, qualifiers 17 or 28 are always responded.)

Note 3: Cold restarts are implemented the same as warm restarts – the T60 is not restarted, but the DNP process is restarted.

Table E-2: IMPLEMENTATION TABLE (Sheet 2 of 4)

OBJECT			REQUEST		RESPONSE	
OBJECT NO.	VARIATION NO.	DESCRIPTION	FUNCTION CODES (DEC)	QUALIFIER CODES (HEX)	FUNCTION CODES (DEC)	QUALIFIER CODES (HEX)
20 cont'd	2	16-Bit Binary Counter	1 (read) 7 (freeze) 8 (freeze noack) 9 (freeze clear) 10 (frz. cl. noack) 22 (assign class)	00, 01 (start-stop) 06 (no range, or all) 07, 08 (limited quantity) 17, 28 (index)	129 (response)	00, 01 (start-stop) 17, 28 (index) (see Note 2)
	5	32-Bit Binary Counter without Flag	1 (read) 7 (freeze) 8 (freeze noack) 9 (freeze clear) 10 (frz. cl. noack) 22 (assign class)	00, 01 (start-stop) 06 (no range, or all) 07, 08 (limited quantity) 17, 28 (index)	129 (response)	00, 01 (start-stop) 17, 28 (index) (see Note 2)
	6	16-Bit Binary Counter without Flag	1 (read) 7 (freeze) 8 (freeze noack) 9 (freeze clear) 10 (frz. cl. noack) 22 (assign class)	00, 01 (start-stop) 06 (no range, or all) 07, 08 (limited quantity) 17, 28 (index)	129 (response)	00, 01 (start-stop) 17, 28 (index) (see Note 2)
21	0	Frozen Counter (Variation 0 is used to request default variation)	1 (read) 22 (assign class)	00, 01 (start-stop) 06 (no range, or all) 07, 08 (limited quantity) 17, 28 (index)		
	1	32-Bit Frozen Counter	1 (read) 22 (assign class)	00, 01 (start-stop) 06 (no range, or all) 07, 08 (limited quantity) 17, 28 (index)	129 (response)	00, 01 (start-stop) 17, 28 (index) (see Note 2)
	2	16-Bit Frozen Counter	1 (read) 22 (assign class)	00, 01 (start-stop) 06 (no range, or all) 07, 08 (limited quantity) 17, 28 (index)	129 (response)	00, 01 (start-stop) 17, 28 (index) (see Note 2)
	9	32-Bit Frozen Counter without Flag	1 (read) 22 (assign class)	00, 01 (start-stop) 06 (no range, or all) 07, 08 (limited quantity) 17, 28 (index)	129 (response)	00, 01 (start-stop) 17, 28 (index) (see Note 2)
	10	16-Bit Frozen Counter without Flag	1 (read) 22 (assign class)	00, 01 (start-stop) 06 (no range, or all) 07, 08 (limited quantity) 17, 28 (index)	129 (response)	00, 01 (start-stop) 17, 28 (index) (see Note 2)
22	0	Counter Change Event (Variation 0 is used to request default variation)	1 (read)	06 (no range, or all) 07, 08 (limited quantity)		
	1	32-Bit Counter Change Event	1 (read)	06 (no range, or all) 07, 08 (limited quantity)	129 (response) 130 (unsol. resp.)	17, 28 (index)
	2	16-Bit Counter Change Event	1 (read)	06 (no range, or all) 07, 08 (limited quantity)	129 (response) 130 (unsol. resp.)	17, 28 (index)
	5	32-Bit Counter Change Event with Time	1 (read)	06 (no range, or all) 07, 08 (limited quantity)	129 (response) 130 (unsol. resp.)	17, 28 (index)
	6	16-Bit Counter Change Event with Time	1 (read)	06 (no range, or all) 07, 08 (limited quantity)	129 (response) 130 (unsol. resp.)	17, 28 (index)
23	0	Frozen Counter Event (Variation 0 is used to request default variation)	1 (read)	06 (no range, or all) 07, 08 (limited quantity)		
	1	32-Bit Frozen Counter Event	1 (read)	06 (no range, or all) 07, 08 (limited quantity)	129 (response) 130 (unsol. resp.)	17, 28 (index)
	2	16-Bit Frozen Counter Event	1 (read)	06 (no range, or all) 07, 08 (limited quantity)	129 (response) 130 (unsol. resp.)	17, 28 (index)

Note 1: A default variation refers to the variation responded when variation 0 is requested and/or in class 0, 1, 2, or 3 scans. The default variations for object types 1, 2, 20, 21, 22, 23, 30, and 32 are selected via relay settings. Refer to the *Communications* section in Chapter 5 for details. This optimizes the class 0 poll data size.

Note 2: For static (non-change-event) objects, qualifiers 17 or 28 are only responded when a request is sent with qualifiers 17 or 28, respectively. Otherwise, static object requests sent with qualifiers 00, 01, 06, 07, or 08, will be responded with qualifiers 00 or 01 (for change-event objects, qualifiers 17 or 28 are always responded.)

Note 3: Cold restarts are implemented the same as warm restarts – the T60 is not restarted, but the DNP process is restarted.

Table E–2: IMPLEMENTATION TABLE (Sheet 3 of 4)

OBJECT			REQUEST		RESPONSE	
OBJECT NO.	VARIATION NO.	DESCRIPTION	FUNCTION CODES (DEC)	QUALIFIER CODES (HEX)	FUNCTION CODES (DEC)	QUALIFIER CODES (HEX)
23 cont'd	5	32-Bit Frozen Counter Event with Time	1 (read)	06 (no range, or all) 07, 08 (limited quantity)	129 (response) 130 (unsol. resp.)	17, 28 (index)
	6	16-Bit Frozen Counter Event with Time	1 (read)	06 (no range, or all) 07, 08 (limited quantity)	129 (response) 130 (unsol. resp.)	17, 28 (index)
30	0	Analog Input (Variation 0 is used to request default variation)	1 (read) 22 (assign class)	00, 01 (start-stop) 06 (no range, or all) 07, 08 (limited quantity) 17, 28 (index)		
	1	32-Bit Analog Input	1 (read) 22 (assign class)	00, 01 (start-stop) 06 (no range, or all) 07, 08 (limited quantity) 17, 28 (index)	129 (response)	00, 01 (start-stop) 17, 28 (index) (see Note 2)
	2	16-Bit Analog Input	1 (read) 22 (assign class)	00, 01 (start-stop) 06 (no range, or all) 07, 08 (limited quantity) 17, 28 (index)	129 (response)	00, 01 (start-stop) 17, 28 (index) (see Note 2)
	3	32-Bit Analog Input without Flag	1 (read) 22 (assign class)	00, 01 (start-stop) 06 (no range, or all) 07, 08 (limited quantity) 17, 28 (index)	129 (response)	00, 01 (start-stop) 17, 28 (index) (see Note 2)
	4	16-Bit Analog Input without Flag	1 (read) 22 (assign class)	00, 01 (start-stop) 06 (no range, or all) 07, 08 (limited quantity) 17, 28 (index)	129 (response)	00, 01 (start-stop) 17, 28 (index) (see Note 2)
	5	short floating point	1 (read) 22 (assign class)	00, 01 (start-stop) 06 (no range, or all) 07, 08 (limited quantity) 17, 28 (index)	129 (response)	00, 01 (start-stop) 17, 28 (index) (see Note 2)
32	0	Analog Change Event (Variation 0 is used to request default variation)	1 (read)	06 (no range, or all) 07, 08 (limited quantity)		
	1	32-Bit Analog Change Event without Time	1 (read)	06 (no range, or all) 07, 08 (limited quantity)	129 (response) 130 (unsol. resp.)	17, 28 (index)
	2	16-Bit Analog Change Event without Time	1 (read)	06 (no range, or all) 07, 08 (limited quantity)	129 (response) 130 (unsol. resp.)	17, 28 (index)
	3	32-Bit Analog Change Event with Time	1 (read)	06 (no range, or all) 07, 08 (limited quantity)	129 (response) 130 (unsol. resp.)	17, 28 (index)
	4	16-Bit Analog Change Event with Time	1 (read)	06 (no range, or all) 07, 08 (limited quantity)	129 (response) 130 (unsol. resp.)	17, 28 (index)
	5	short floating point Analog Change Event without Time	1 (read)	06 (no range, or all) 07, 08 (limited quantity)	129 (response) 130 (unsol. resp.)	17, 28 (index)
	7	short floating point Analog Change Event with Time	1 (read)	06 (no range, or all) 07, 08 (limited quantity)	129 (response) 130 (unsol. resp.)	17, 28 (index)
34	0	Analog Input Reporting Deadband (Variation 0 is used to request default variation)	1 (read)	00, 01 (start-stop) 06 (no range, or all) 07, 08 (limited quantity) 17, 28 (index)		
	1	16-bit Analog Input Reporting Deadband (default – see Note 1)	1 (read)	00, 01 (start-stop) 06 (no range, or all) 07, 08 (limited quantity) 17, 28 (index)	129 (response)	00, 01 (start-stop) 17, 28 (index) (see Note 2)
			2 (write)	00, 01 (start-stop) 07, 08 (limited quantity) 17, 28 (index)		

Note 1: A default variation refers to the variation responded when variation 0 is requested and/or in class 0, 1, 2, or 3 scans. The default variations for object types 1, 2, 20, 21, 22, 23, 30, and 32 are selected via relay settings. Refer to the *Communications* section in Chapter 5 for details. This optimizes the class 0 poll data size.

Note 2: For static (non-change-event) objects, qualifiers 17 or 28 are only responded when a request is sent with qualifiers 17 or 28, respectively. Otherwise, static object requests sent with qualifiers 00, 01, 06, 07, or 08, will be responded with qualifiers 00 or 01 (for change-event objects, qualifiers 17 or 28 are always responded.)

Note 3: Cold restarts are implemented the same as warm restarts – the T60 is not restarted, but the DNP process is restarted.

Table E-2: IMPLEMENTATION TABLE (Sheet 4 of 4)

OBJECT			REQUEST		RESPONSE	
OBJECT NO.	VARIATION NO.	DESCRIPTION	FUNCTION CODES (DEC)	QUALIFIER CODES (HEX)	FUNCTION CODES (DEC)	QUALIFIER CODES (HEX)
34 cont'd	2	32-bit Analog Input Reporting Deadband	1 (read)	00, 01 (start-stop) 06 (no range, or all) 07, 08 (limited quantity) 17, 28 (index)	129 (response)	00, 01 (start-stop) 17, 28 (index) (see Note 2)
			2 (write)	00, 01 (start-stop) 07, 08 (limited quantity) 17, 28 (index)		
	3	Short floating point Analog Input Reporting Deadband	1 (read)	00, 01 (start-stop) 06 (no range, or all) 07, 08 (limited quantity) 17, 28 (index)	129 (response)	00, 01 (start-stop) 17, 28 (index) (see Note 2)
50	1	Time and Date (default – see Note 1)	1 (read)	00, 01 (start-stop)	129 (response)	00, 01 (start-stop) 17, 28 (index) (see Note 2)
			2 (write)	06 (no range, or all) 07 (limited qty=1) 08 (limited quantity) 17, 28 (index)		
52	2	Time Delay Fine			129 (response)	07 (limited quantity) (quantity = 1)
60	0	Class 0, 1, 2, and 3 Data	1 (read)	06 (no range, or all)		
			20 (enable unsol)			
			21 (disable unsol)			
			22 (assign class)			
			1 (read)			
22 (assign class)						
2 (read)	06 (no range, or all)					
1 (read)						
3 (read)	07, 08 (limited quantity)					
20 (enable unsol)						
4 (read)	07, 08 (limited quantity)					
21 (disable unsol)						
22 (assign class)						
70	1	File identifier	2 (write)	1b (free format)	129 (response)	1b (free format)
			3	File command	25 (open) 27 (delete)	5b (free format)
	4	File command status	1 (read)	06 (no range, or all) 07, 08 (limited quantity) 5b (free format)	129 (response)	5b (free format)
			22 (assign class) 26 (close) 30 (abort)		130 (unsol. resp.)	
	5	File transfer	1 (read)	06 (no range, or all) 07, 08 (limited quantity) 5b (free format)	129 (response)	5b (free format)
			2 (write) 22 (assign class)		130 (unsol. resp.)	
	6	File transfer status	1 (read) 22 (assign class)	06 (no range, or all) 07, 08 (limited quantity)	129 (response) 130 (unsol. resp.)	5b (free format)
7	File descriptor	1 (read)	06 (no range, or all) 07, 08 (limited quantity) 5b (free format)	129 (response)	5b (free format)	
		22 (assign class) 28 (get file info.)		130 (unsol. resp.)		
80	1	Internal Indications	2 (write)	00 (start-stop) (index must =7)		
---		No Object (function code only) see Note 3	13 (cold restart)			
---		No Object (function code only)	14 (warm restart)			
---		No Object (function code only)	23 (delay meas.)			

Note 1: A default variation refers to the variation responded when variation 0 is requested and/or in class 0, 1, 2, or 3 scans. The default variations for object types 1, 2, 20, 21, 22, 23, 30, and 32 are selected via relay settings. Refer to the *Communications* section in Chapter 5 for details. This optimizes the class 0 poll data size.

Note 2: For static (non-change-event) objects, qualifiers 17 or 28 are only responded when a request is sent with qualifiers 17 or 28, respectively. Otherwise, static object requests sent with qualifiers 00, 01, 06, 07, or 08, will be responded with qualifiers 00 or 01 (for change-event objects, qualifiers 17 or 28 are always responded.)

Note 3: Cold restarts are implemented the same as warm restarts – the T60 is not restarted, but the DNP process is restarted.



E.2.1 BINARY INPUT POINTS

The DNP binary input data points are configured through the **PRODUCT SETUP** ⇨ ⇩ **COMMUNICATIONS** ⇨ ⇩ **DNP / IEC104 POINT LISTS** ⇨ **BINARY INPUT / MSP POINTS** menu. Refer to the *Communications* section of Chapter 5 for additional details. When a freeze function is performed on a binary counter point, the frozen value is available in the corresponding frozen counter point.

BINARY INPUT POINTS

Static (Steady-State) Object Number: **1**

Change Event Object Number: **2**

Request Function Codes supported: **1 (read), 22 (assign class)**

Static Variation reported when variation 0 requested: **2 (Binary Input with status)**

Change Event Variation reported when variation 0 requested: **2 (Binary Input Change with Time)**

Change Event Scan Rate: **8 times per power system cycle**

Change Event Buffer Size: **1000**

E.2.2 BINARY AND CONTROL RELAY OUTPUT

Supported Control Relay Output Block fields: Pulse On, Pulse Off, Latch On, Latch Off, Paired Trip, Paired Close.

BINARY OUTPUT STATUS POINTS

Object Number: **10**

Request Function Codes supported: **1 (read)**

Default Variation reported when Variation 0 requested: **2 (Binary Output Status)**

CONTROL RELAY OUTPUT BLOCKS

Object Number: **12**

Request Function Codes supported: **3 (select), 4 (operate), 5 (direct operate), 6 (direct operate, noack)**

Table E-3: BINARY/CONTROL OUTPUTS

POINT	NAME/DESCRIPTION
0	Virtual Input 1
1	Virtual Input 2
2	Virtual Input 3
3	Virtual Input 4
4	Virtual Input 5
5	Virtual Input 6
6	Virtual Input 7
7	Virtual Input 8
8	Virtual Input 9
9	Virtual Input 10
10	Virtual Input 11
11	Virtual Input 12
12	Virtual Input 13
13	Virtual Input 14
14	Virtual Input 15
15	Virtual Input 16
16	Virtual Input 17
17	Virtual Input 18
18	Virtual Input 19
19	Virtual Input 20
20	Virtual Input 21
21	Virtual Input 22
22	Virtual Input 23
23	Virtual Input 24
24	Virtual Input 25
25	Virtual Input 26
26	Virtual Input 27
27	Virtual Input 28
28	Virtual Input 29
29	Virtual Input 30
30	Virtual Input 31
31	Virtual Input 32

Table E-3: BINARY/CONTROL OUTPUTS

POINT	NAME/DESCRIPTION
32	Virtual Input 33
33	Virtual Input 34
34	Virtual Input 35
35	Virtual Input 36
36	Virtual Input 37
37	Virtual Input 38
38	Virtual Input 39
39	Virtual Input 40
40	Virtual Input 41
41	Virtual Input 42
42	Virtual Input 43
43	Virtual Input 44
44	Virtual Input 45
45	Virtual Input 46
46	Virtual Input 47
47	Virtual Input 48
48	Virtual Input 49
49	Virtual Input 50
50	Virtual Input 51
51	Virtual Input 52
52	Virtual Input 53
53	Virtual Input 54
54	Virtual Input 55
55	Virtual Input 56
56	Virtual Input 57
57	Virtual Input 58
58	Virtual Input 59
59	Virtual Input 60
60	Virtual Input 61
61	Virtual Input 62
62	Virtual Input 63
63	Virtual Input 64

E.2.3 COUNTERS

The following table lists both Binary Counters (Object 20) and Frozen Counters (Object 21). When a freeze function is performed on a Binary Counter point, the frozen value is available in the corresponding Frozen Counter point.

BINARY COUNTERS

Static (Steady-State) Object Number: **20**

Change Event Object Number: **22**

Request Function Codes supported: **1 (read), 7 (freeze), 8 (freeze noack), 9 (freeze and clear), 10 (freeze and clear, noack), 22 (assign class)**

Static Variation reported when variation 0 requested: **1 (32-Bit Binary Counter with Flag)**

Change Event Variation reported when variation 0 requested: **1 (32-Bit Counter Change Event without time)**

Change Event Buffer Size: **10**

Default Class for all points: **2**

FROZEN COUNTERS

Static (Steady-State) Object Number: **21**

Change Event Object Number: **23**

Request Function Codes supported: **1 (read)**

Static Variation reported when variation 0 requested: **1 (32-Bit Frozen Counter with Flag)**

Change Event Variation reported when variation 0 requested: **1 (32-Bit Frozen Counter Event without time)**

Change Event Buffer Size: **10**

Default Class for all points: **2**

Table E-4: BINARY AND FROZEN COUNTERS

POINT INDEX	NAME/DESCRIPTION
0	Digital Counter 1
1	Digital Counter 2
2	Digital Counter 3
3	Digital Counter 4
4	Digital Counter 5
5	Digital Counter 6
6	Digital Counter 7
7	Digital Counter 8
8	Oscillography Trigger Count
9	Events Since Last Clear

A counter freeze command has no meaning for counters 8 and 9. T60 Digital Counter values are represented as 32-bit integers. The DNP 3.0 protocol defines counters to be unsigned integers. Care should be taken when interpreting negative counter values.

E.2.4 ANALOG INPUTS

The DNP analog input data points are configured through the **PRODUCT SETUP** ⇨ ⇩ **COMMUNICATIONS** ⇨ ⇩ **DNP / IEC104 POINT LISTS** ⇨ **ANALOG INPUT / MME POINTS** menu. Refer to the *Communications* section of Chapter 5 for additional details.

It is important to note that 16-bit and 32-bit variations of analog inputs are transmitted through DNP as signed numbers. Even for analog input points that are not valid as negative values, the maximum positive representation is 32767 for 16-bit values and 2147483647 for 32-bit values. This is a DNP requirement.

The deadbands for all Analog Input points are in the same units as the Analog Input quantity. For example, an Analog Input quantity measured in volts has a corresponding deadband in units of volts. This is in conformance with DNP Technical Bulletin 9809-001: Analog Input Reporting Deadband. Relay settings are available to set default deadband values according to data type. Deadbands for individual Analog Input Points can be set using DNP Object 34.

Static (Steady-State) Object Number: **30**

Change Event Object Number: **32**

Request Function Codes supported: **1 (read), 2 (write, deadbands only), 22 (assign class)**

Static Variation reported when variation 0 requested: **1 (32-Bit Analog Input)**

Change Event Variation reported when variation 0 requested: **1 (Analog Change Event without Time)**

Change Event Scan Rate: defaults to **500 ms**

Change Event Buffer Size: **800**

Default Class for all Points: **1**

F.1.1 REVISION HISTORY

MANUAL P/N	REVISION	RELEASE DATE	ECO
1601-0090-0.1	1.6x Beta	11 August 1999	N/A
1601-0090-A1	1.8x	29 October 1999	N/A
1601-0090-A2	2.0x	17 December 1999	URT-003
1601-0090-A3	2.2x	12 May 2000	URT-004
1601-0090-A4	2.2x	14 June 2000	URT-005
1601-0090-A4a	2.2x	28 June 2000	URT-005a
1601-0090-B1	2.4x	08 September 2000	URT-006
1601-0090-B2	2.4x	03 November 2000	URT-007
1601-0090-B3	2.6x	09 March 2001	URT-008
1601-0090-B4	2.8x	26 September 2001	URT-009
1601-0090-B5	2.9x	03 December 2001	URT-011
1601-0090-B6	2.6x	27 February 2004	URX-120
1601-0090-C1	3.0x	02 July 2002	URT-013
1601-0090-C2	3.1x	30 August 2002	URT-018
1601-0090-C3	3.0x	18 November 2002	URT-021
1601-0090-C4	3.1x	18 November 2002	URT-022
1601-0090-C5	3.0x	11 February 2003	URT-024
1601-0090-C6	3.1x	11 February 2003	URT-026
1601-0090-D1	3.2x	11 February 2003	URT-028
1601-0090-D2	3.2x	02 June 2003	URX-084
1601-0090-E1	3.3x	01 May 2003	URX-080
1601-0090-E2	3.3x	29 May 2003	URX-083
1601-0090-F1	3.4x	10 December 2003	URX-111
1601-0090-F2	3.4x	09 February 2004	URX-115
1601-0090-G1	4.0x	23 March 2004	URX-123
1601-0090-G2	4.0x	17 May 2004	URX-136
1601-0090-H1	4.2x	30 June 2004	URX-145
1601-0090-H2	4.2x	23 July 2004	URX-151
1601-0090-J1	4.4x	15 September 2004	URX-156
1601-0090-K1	4.6x	15 February 2005	URX-176
1601-0090-L1	4.8x	05 August 2005	URX-202
1601-0090-L2	4.8x	30 March 2006	URX-216

F.1.2 CHANGES TO THE T60 MANUAL

Table F-1: MAJOR UPDATES FOR T60 MANUAL REVISION L2 (Sheet 1 of 2)

PAGE (L1)	PAGE (L2)	CHANGE	DESCRIPTION
Title	Title	Update	Manual part number to 1601-0090-L2
2-4	2-4	Update	Updated T60 ORDER CODES table
5-17	5-16	Update	Updated IEC 61850 PROTOCOL sub-section
5-51	5-50	Update	Updated GENERAL TRANSFORMER SETTINGS sub-section
5-59	5-58	Update	Updated MAGNITUDE, PHASE ANGLE, AND ZERO SEQUENCE COMPENSATION sub-section
5-72	5-71	Update	Updated FLEXLOGIC™ OPERANDS table

Table F-1: MAJOR UPDATES FOR T60 MANUAL REVISION L2 (Sheet 2 of 2)

PAGE (L1)	PAGE (L2)	CHANGE	DESCRIPTION
5-90	5-89	Update	Updated PERCENT DIFFERENTIAL section

Table F-2: MAJOR UPDATES FOR T60 MANUAL REVISION L1

PAGE (K1)	PAGE (L1)	CHANGE	DESCRIPTION
Title	Title	Update	Manual part number to 1601-0090-L1
2-4	2-4	Update	Updated T60 ORDER CODES table
2-5	2-5	Update	Updated ORDER CODES FOR REPLACEMENT MODULES table
2-10	2-10	Update	Updated INPUTS specifications section
2-12	2-12	Update	Updated COMMUNICATIONS specifications section
3-8	3-7	Update	Updated CONTROL POWER section
3-10	3-10	Update	Updated CONTACT INPUTS/OUTPUTS section
3-18	3-18	Update	Updated CPU COMMUNICATIONS PORTS section
3-19	3-20	Update	Updated RS485 SERIAL CONNECTION diagram
3-24	3-25	Update	Updated G.703 INTERFACE section
3-29	3-30	Update	Updated RS422 AND FIBER INTERFACE CONNECTION drawing
---	3-33	Add	Added C37.94SM INTERFACE section
---	4-13	Add	Added INVALID PASSWORD ENTRY section
5-13	5-14	Update	Updated DNP PROTOCOL sub-section
---	5-16	Add	Added DNP / IEC 60870-5-104 POINT LISTS sub-section
5-15	5-17	Update	Updated IEC 61850 PROTOCOL sub-section
5-18	5-20	Update	Updated IEC 60870-5-104 PROTOCOL sub-section
5-25	5-27	Update	Updated DATA LOGGER section
---	5-44	Add	Added TELEPROTECTION section
5-68	5-72	Update	Updated FLEXLOGIC™ OPERANDS table
5-126	5-131	Update	Updated SETTING GROUPS section
5-127	5-132	Update	Updated SELECTOR SWITCH section
5-148	5-154	Update	Updated REMOTE INPUTS section
5-150	5-156	Update	Updated DIRECT INPUTS/OUTPUTS section
---	5-160	Add	Added TELEPROTECTION INPUTS/OUTPUTS section
---	6-4	Add	Added TELEPROTECTION INPUTS section
---	6-8	Add	Added TELEPROTECTION CHANNEL TESTS section
B-8	B-8	Update	Updated MODBUS MEMORY MAP for release 4.8x
D-9	D-9	Update	Updated IEC 60870-5-104 POINT LIST sub-section
E-8	E-8	Update	Updated BINARY INPUT POINTS section
E-14	E-9	Update	Updated BINARY AND CONTROL RELAY OUTPUT POINTS section
E-16	E-11	Update	Updated ANALOG INPUTS section

Table F-3: MAJOR UPDATES FOR T60 MANUAL REVISION K1

PAGE (J1)	PAGE (K1)	CHANGE	DESCRIPTION
Title	Title	Update	Manual part number to 1601-0109-K1
2-4	2-4	Update	Updated T60 ORDER CODES table
3-6	3-6	Update	Updated TYPICAL WIRING DIAGRAM to 828749A3
3-19	3-19	Update	Updated RS485 SERIAL CONNECTION diagram to 827757A7
5-8	5-8	Update	Updated DISPLAY PROPERTIES section
5-13	5-13	Update	Updated DNP PROTOCOL sub-section
5-15	5-15	Update	Updated IEC 61850 PROTOCOL sub-section
5-133	5-134	Update	Updated DIGITAL ELEMENTS section
5-143	5-144	Update	The LATCHING OUTPUTS section is now a sub-section of the CONTACT OUTPUTS
5-146	5-147	Update	Updated REMOTE DEVICES section
5-148	5-149	Update	Updated REMOTE OUTPUTS section
B-8	B-8	Update	Updated MODBUS MEMORY MAP for revision 4.6x
---	C-1	Add	Added IEC 61850 COMMUNICATIONS appendix
D-4	E-4	Update	Updated DNP IMPLEMENTATION section

Table F-4: MAJOR UPDATES FOR T60 MANUAL REVISION J1

PAGE (H2)	PAGE (J1)	CHANGE	DESCRIPTION
Title	Title	Update	Manual part number to 1601-0109-J1
5-15	---	Remove	Removed UCA/MMS PROTOCOL sub-section
---	5-15	Add	Added IEC 61850 PROTOCOL sub-section
5-45	5-45	Update	Updated TRANSFORMER section
---	5-56	Add	Added TRANSFORMER THERMAL INPUTS sub-section
---	5-87	Add	Added HOTTEST-SPOT TEMPERATURE sub-section
---	5-88	Add	Added AGING FACTOR sub-section
---	5-89	Add	Added LOSS OF LIFE sub-section
5-137	5-141	Update	Updated VIRTUAL INPUTS section
---	6-11	Add	Added THERMAL ELEMENTS sub-section
B-8	B-8	Update	Updated MODBUS MEMORY MAP for revision 4.4x
C-1	---	Remove	Removed UCA/MMS COMMUNICATIONS appendix

Table F-5: MAJOR UPDATES FOR T60 MANUAL REVISION H2

PAGE (H1)	PAGE (H2)	CHANGE	DESCRIPTION
Title	Title	Update	Manual part number to 1601-0090-H2
3-22	3-22	Update	Updated CHANNEL COMMUNICATION OPTIONS table

F.2.1 STANDARD ABBREVIATIONS

A.....	Ampere	FREQ.....	Frequency
AC.....	Alternating Current	FSK.....	Frequency-Shift Keying
A/D.....	Analog to Digital	FTP.....	File Transfer Protocol
AE.....	Accidental Energization, Application Entity	FxE.....	FlexElement™
AMP.....	Ampere	FWD.....	Forward
ANG.....	Angle		
ANSI.....	American National Standards Institute	G.....	Generator
AR.....	Automatic Reclosure	GE.....	General Electric
ASDU.....	Application-layer Service Data Unit	GND.....	Ground
ASYM.....	Asymmetry	GNTR.....	Generator
AUTO.....	Automatic	GOOSE.....	General Object Oriented Substation Event
AUX.....	Auxiliary	GPS.....	Global Positioning System
AVG.....	Average		
		HARM.....	Harmonic / Harmonics
BER.....	Bit Error Rate	HCT.....	High Current Time
BF.....	Breaker Fail	HGF.....	High-Impedance Ground Fault (CT)
BFI.....	Breaker Failure Initiate	HIZ.....	High-Impedance and Arcing Ground
BKR.....	Breaker	HMI.....	Human-Machine Interface
BLK.....	Block	HTTP.....	Hyper Text Transfer Protocol
BLKG.....	Blocking	HYB.....	Hybrid
BPNT.....	Breakpoint of a characteristic		
BRKR.....	Breaker	I.....	Instantaneous
		I ₀	Zero Sequence current
CAP.....	Capacitor	I ₁	Positive Sequence current
CC.....	Coupling Capacitor	I ₂	Negative Sequence current
CCVT.....	Coupling Capacitor Voltage Transformer	IA.....	Phase A current
CFG.....	Configure / Configurable	IAB.....	Phase A minus B current
.CFG.....	Filename extension for oscillography files	IB.....	Phase B current
CHK.....	Check	IBC.....	Phase B minus C current
CHNL.....	Channel	IC.....	Phase C current
CLS.....	Close	ICA.....	Phase C minus A current
CLSD.....	Closed	ID.....	Identification
CMND.....	Command	IED.....	Intelligent Electronic Device
CMPRSN.....	Comparison	IEC.....	International Electrotechnical Commission
CO.....	Contact Output	IEEE.....	Institute of Electrical and Electronic Engineers
COM.....	Communication	IG.....	Ground (not residual) current
COMM.....	Communications	Igd.....	Differential Ground current
COMP.....	Compensated, Comparison	IN.....	CT Residual Current (3I ₀) or Input
CONN.....	Connection	INC SEQ.....	Incomplete Sequence
CONT.....	Continuous, Contact	INIT.....	Initiate
CO-ORD.....	Coordination	INST.....	Instantaneous
CPU.....	Central Processing Unit	INV.....	Inverse
CRC.....	Cyclic Redundancy Code	I/O.....	Input/Output
CRT, CRNT.....	Current	IOC.....	Instantaneous Overcurrent
CSA.....	Canadian Standards Association	IOV.....	Instantaneous Overvoltage
CT.....	Current Transformer	IRIG.....	Inter-Range Instrumentation Group
CVT.....	Capacitive Voltage Transformer	ISO.....	International Standards Organization
		IUV.....	Instantaneous Undervoltage
D/A.....	Digital to Analog		
DC (dc).....	Direct Current	K0.....	Zero Sequence Current Compensation
DD.....	Disturbance Detector	kA.....	kiloAmpere
DFLT.....	Default	kV.....	kiloVolt
DGNST.....	Diagnostics		
DI.....	Digital Input	LED.....	Light Emitting Diode
DIFF.....	Differential	LEO.....	Line End Open
DIR.....	Directional	LFT BLD.....	Left Blinder
DISCREP.....	Discrepancy	LOOP.....	Loopback
DIST.....	Distance	LPU.....	Line Pickup
DMD.....	Demand	LRA.....	Locked-Rotor Current
DNP.....	Distributed Network Protocol	LTC.....	Load Tap-Changer
DPO.....	Dropout		
DSP.....	Digital Signal Processor	M.....	Machine
dt.....	Rate of Change	mA.....	MilliAmpere
DTT.....	Direct Transfer Trip	MAG.....	Magnitude
DUTT.....	Direct Under-reaching Transfer Trip	MAN.....	Manual / Manually
		MAX.....	Maximum
ENCRMNT.....	Encroachment	MIC.....	Model Implementation Conformance
EPRI.....	Electric Power Research Institute	MIN.....	Minimum, Minutes
.EVT.....	Filename extension for event recorder files	MMI.....	Man Machine Interface
EXT.....	Extension, External	MMS.....	Manufacturing Message Specification
		MRT.....	Minimum Response Time
F.....	Field	MSG.....	Message
FAIL.....	Failure	MTA.....	Maximum Torque Angle
FD.....	Fault Detector	MTR.....	Motor
FDH.....	Fault Detector high-set	MVA.....	MegaVolt-Ampere (total 3-phase)
FDL.....	Fault Detector low-set	MVA_A.....	MegaVolt-Ampere (phase A)
FLA.....	Full Load Current	MVA_B.....	MegaVolt-Ampere (phase B)
FO.....	Fiber Optic	MVA_C.....	MegaVolt-Ampere (phase C)

MVAR.....	MegaVar (total 3-phase)	SAT.....	CT Saturation
MVAR_A.....	MegaVar (phase A)	SBO.....	Select Before Operate
MVAR_B.....	MegaVar (phase B)	SCADA.....	Supervisory Control and Data Acquisition
MVAR_C.....	MegaVar (phase C)	SEC.....	Secondary
MVARH.....	MegaVar-Hour	SEL.....	Select / Selector / Selection
MW.....	MegaWatt (total 3-phase)	SENS.....	Sensitive
MW_A.....	MegaWatt (phase A)	SEQ.....	Sequence
MW_B.....	MegaWatt (phase B)	SIR.....	Source Impedance Ratio
MW_C.....	MegaWatt (phase C)	SNTP.....	Simple Network Time Protocol
MWH.....	MegaWatt-Hour	SRC.....	Source
N.....	Neutral	SSB.....	Single Side Band
N/A, n/a.....	Not Applicable	SSEL.....	Session Selector
NEG.....	Negative	STATS.....	Statistics
NMPLT.....	Nameplate	SUPN.....	Supervision
NOM.....	Nominal	SUPV.....	Supervise / Supervision
NSAP.....	Network Service Access Protocol	SV.....	Supervision, Service
NTR.....	Neutral	SYNC.....	Synchrocheck
		SYNCHCHK.....	Synchrocheck
O.....	Over	T.....	Time, transformer
OC, O/C.....	Overcurrent	TC.....	Thermal Capacity
O/P, Op.....	Output	TCP.....	Transmission Control Protocol
OP.....	Operate	TCU.....	Thermal Capacity Used
OPER.....	Operate	TD MULT.....	Time Dial Multiplier
OPERATG.....	Operating	TEMP.....	Temperature
O/S.....	Operating System	TFTP.....	Trivial File Transfer Protocol
OSI.....	Open Systems Interconnect	THD.....	Total Harmonic Distortion
OSB.....	Out-of-Step Blocking	TMR.....	Timer
OUT.....	Output	TOC.....	Time Overcurrent
OV.....	Overvoltage	TOV.....	Time Overvoltage
OVERFREQ.....	Overfrequency	TRANS.....	Transient
OVLN.....	Overload	TRANSF.....	Transfer
		TSEL.....	Transport Selector
P.....	Phase	TUC.....	Time Undercurrent
PC.....	Phase Comparison, Personal Computer	TUV.....	Time Undervoltage
PCNT.....	Percent	TX (Tx).....	Transmit, Transmitter
PF.....	Power Factor (total 3-phase)		
PF_A.....	Power Factor (phase A)	U.....	Under
PF_B.....	Power Factor (phase B)	UC.....	Undercurrent
PF_C.....	Power Factor (phase C)	UCA.....	Utility Communications Architecture
PFL.....	Phase and Frequency Lock Loop	UDP.....	User Datagram Protocol
PHS.....	Phase	UL.....	Underwriters Laboratories
PICS.....	Protocol Implementation & Conformance Statement	UNBAL.....	Unbalance
PKP.....	Pickup	UR.....	Universal Relay
PLC.....	Power Line Carrier	URC.....	Universal Recloser Control
POS.....	Positive	.URS.....	Filename extension for settings files
POTT.....	Permissive Over-reaching Transfer Trip	UV.....	Undervoltage
PRESS.....	Pressure		
PRI.....	Primary	V/Hz.....	Volts per Hertz
PROT.....	Protection	V_0.....	Zero Sequence voltage
PSEL.....	Presentation Selector	V_1.....	Positive Sequence voltage
pu.....	Per Unit	V_2.....	Negative Sequence voltage
PUIB.....	Pickup Current Block	VA.....	Phase A voltage
PUIT.....	Pickup Current Trip	VAB.....	Phase A to B voltage
PUSHBTN.....	Pushbutton	VAG.....	Phase A to Ground voltage
PUTT.....	Permissive Under-reaching Transfer Trip	VARH.....	Var-hour voltage
PWM.....	Pulse Width Modulated	VB.....	Phase B voltage
PWR.....	Power	VBA.....	Phase B to A voltage
		VBG.....	Phase B to Ground voltage
QUAD.....	Quadrilateral	VC.....	Phase C voltage
		VCA.....	Phase C to A voltage
R.....	Rate, Reverse	VCG.....	Phase C to Ground voltage
RCA.....	Reach Characteristic Angle	VF.....	Variable Frequency
REF.....	Reference	VIBR.....	Vibration
REM.....	Remote	VT.....	Voltage Transformer
REV.....	Reverse	VTFF.....	Voltage Transformer Fuse Failure
RI.....	Reclose Initiate	VTLOS.....	Voltage Transformer Loss Of Signal
RIP.....	Reclose In Progress		
RGT BLD.....	Right Blinder	WDG.....	Winding
ROD.....	Remote Open Detector	WH.....	Watt-hour
RST.....	Reset	w/ opt.....	With Option
RSTR.....	Restrained	WRT.....	With Respect To
RTD.....	Resistance Temperature Detector		
RTU.....	Remote Terminal Unit	X.....	Reactance
RX (Rx).....	Receive, Receiver	XDUCER.....	Transducer
		XFMR.....	Transformer
s.....	second		
S.....	Sensitive	Z.....	Impedance, Zone

GE MULTILIN RELAY WARRANTY

General Electric Multilin Inc. (GE Multilin) warrants each relay it manufactures to be free from defects in material and workmanship under normal use and service for a period of 24 months from date of shipment from factory.

In the event of a failure covered by warranty, GE Multilin will undertake to repair or replace the relay providing the warrantor determined that it is defective and it is returned with all transportation charges prepaid to an authorized service centre or the factory. Repairs or replacement under warranty will be made without charge.

Warranty shall not apply to any relay which has been subject to misuse, negligence, accident, incorrect installation or use not in accordance with instructions nor any unit that has been altered outside a GE Multilin authorized factory outlet.

GE Multilin is not liable for special, indirect or consequential damages or for loss of profit or for expenses sustained as a result of a relay malfunction, incorrect application or adjustment.

For complete text of Warranty (including limitations and disclaimers), refer to GE Multilin Standard Conditions of Sale.

Numerics

10BASE-F
 communications options 3-18
 description 3-20
 interface 3-30
 redundant option 3-18
 settings 5-12

A

ABBREVIATIONS F-4
 AC CURRENT INPUTS 2-10, 3-8, 5-45
 AC VOLTAGE INPUTS 2-10, 3-9
 ACTIVATING THE RELAY 1-12, 4-11
 ACTIVE SETTING GROUP 5-88
 ACTUAL VALUES
 maintenance 6-20
 metering 6-9
 product information 6-21
 status 6-3
 AGING FACTOR
 actual values 6-12
 FlexLogic™ operands 5-73
 logic 5-94
 Modbus registers B-25
 settings 5-94
 specifications 2-7
 ALARM LEDs 5-31
 ALTITUDE 2-13
 ANSI DEVICE NUMBERS 2-1
 APPARENT POWER 2-9, 6-15
 APPLICATION EXAMPLES
 breaker trip circuit integrity 5-141
 contact inputs 5-147
 windings between two breakers 5-59
 APPROVALS 2-14
 ARCHITECTURE 5-69
 ARCING CURRENT 5-144
 AUXILIARY OVERVOLTAGE
 FlexLogic™ operands 5-71
 logic 5-127
 Modbus registers B-30
 settings 5-127
 specifications 2-7
 AUXILIARY UNDERVOLTAGE
 FlexLogic™ operands 5-71
 logic 5-126
 Modbus registers B-30
 settings 5-126
 specifications 2-7
 AUXILIARY VOLTAGE CHANNEL 3-9
 AUXILIARY VOLTAGE METERING 6-14

B

BANKS 5-6, 5-45, 5-46
 BATTERY FAIL 7-5
 BINARY INPUT POINTS E-8
 BINARY OUTPUT POINTS E-9
 BLOCK DIAGRAM 1-3
 BLOCK SETTING 5-4

BREAKER ARCING CURRENT

actual values 6-20
 clearing 5-10, 7-2
 FlexLogic™ operands 5-71
 logic 5-145
 measurement 5-145
 Modbus registers B-13, B-14, B-28
 settings 5-144
 specifications 2-7
 BREAKER-AND-A-HALF SCHEME 5-6
 BRIGHTNESS 5-8

C

C37.94 COMMUNICATIONS 3-31, 3-32, 3-34
 C37.94SM COMMUNICATIONS 3-33
 CE APPROVALS 2-14
 CHANGES TO MANUAL F-1, F-2, F-3
 CHANGES TO T60 MANUAL F-1
 CHANNEL COMMUNICATION 3-23
 CHANNEL TESTS 6-8
 CHANNELS
 banks 5-45, 5-46
 CIRCUIT MONITORING APPLICATIONS 5-139
 CLEANING 2-14
 CLEAR RECORDS 5-10, 7-1
 CLEAR RELAY RECORDS
 Modbus registers B-45
 settings 5-10
 CLOCK
 setting date and time 7-2
 settings 5-22
 COMMANDS MENU 7-1
 COMMUNICATIONS
 10BASE-F 3-18, 3-20, 5-12
 channel 3-23
 connecting to the UR 1-7, 1-8
 CRC-16 error checking B-2
 dnp 5-13, E-1
 EGD 5-20
 G.703 3-26
 half duplex B-1
 HTTP 5-18
 IEC 60870-5-104 protocol 5-19
 IEC 61850 5-16, 5-152
 inter-relay communications 2-13
 Modbus 5-12, 5-22, B-1, B-3
 Modbus registers B-17
 network 5-12
 overview 1-10
 RS232 3-18
 RS485 3-18, 3-20, 5-11
 settings 5-12, 5-13, 5-16, 5-19, 5-20, 5-22
 specifications 2-12, 2-13
 UCA/MMS 5-153
 web server 5-18
 COMPENSATION DE COMPOSANTE HOMOPOLAIRE 5-58
 CONTRADE B-6, B-7
 CONDUCTED RFI 2-14
 CONTACT INFORMATION 1-1
 CONTACT INPUTS
 actual values 6-3
 dry connections 3-15
 FlexLogic™ operands 5-74
 Modbus registers B-10, B-15, B-38, B-40

module assignments 3-11
 settings 5-146
 specifications 2-10
 thresholds 5-146
 wet connections 3-15
 wiring 3-13

CONTACT OUTPUTS
 actual values 6-4
 FlexLogic™ operands 5-74
 Modbus registers B-10, B-15, B-44
 module assignments 3-11
 settings 5-149
 wiring 3-13

CONTROL ELEMENTS 5-130

CONTROL POWER
 description 3-8
 specifications 2-12

CONTROL PUSHBUTTONS
 FlexLogic™ operands 5-71
 Modbus registers B-45
 settings 5-33
 specifications 2-8

COUNTERS
 actual values 6-5
 settings 5-142

CRC ALARM 5-42

CRC-16 ALGORITHM B-2

CRITICAL FAILURE RELAY 2-11, 3-7

CSA APPROVAL 2-14

CT BANKS
 settings 5-45

CT INPUTS 3-9, 5-6, 5-45

CT WIRING 3-9

CURRENT BANK 5-45

CURRENT DEMAND 5-27

CURRENT ELEMENTS 5-96

CURRENT HARMONICS 2-9

CURRENT METERING
 actual values 6-13
 Modbus registers B-11
 specifications 2-9

CURVES
 definite time 5-100, 5-122
 FlexCurves™ 5-62, 5-100
 I2T 5-100
 IAC 5-99
 IEC 5-98
 IEEE 5-97
 inverse time undervoltage 5-122
 types 5-96

D

DATA FORMATS, MODBUS B-51

DATA LOGGER
 clearing 5-10, 7-1
 Modbus B-7
 Modbus registers B-11, B-18, B-19
 settings 5-26
 specifications 2-9
 via COMTRADE B-6

DATE 7-2

DCMA INPUTS 6-18
 Modbus registers B-15, B-28
 settings 5-161
 specifications 2-10

DCMA OUTPUTS
 description 3-17
 Modbus registers B-33
 settings 5-162
 specifications 2-12

DEFINITE TIME CURVE 5-100, 5-122

DEMAND
 Modbus registers B-13, B-21

DEMAND METERING
 actual values 6-15
 settings 5-27
 specifications 2-9

DEMAND RECORDS
 clearing 5-10, 7-2

DESIGN 1-3

DEVICE ID 5-152

DEVICE PROFILE DOCUMENT E-1

DIELECTRIC STRENGTH 2-14, 3-7

DIFFERENTIAL
 actual values 6-12
 instantaneous 5-92
 percent 5-89
 transformer 5-50, 5-52, 5-59, 5-88, 5-89

DIGITAL COUNTERS
 actual values 6-5
 FlexLogic™ operands 5-71
 logic 5-143
 Modbus registers B-9, B-36
 settings 5-142

DIGITAL ELEMENTS
 application example 5-140
 FlexLogic™ operands 5-71
 logic 5-139
 Modbus registers B-31
 settings 5-139

DIGITAL INPUTS
 see entry for CONTACT INPUTS

DIGITAL OUTPUTS
 see entry for CONTACT OUTPUTS

DIMENSIONS 3-1

DIRECT DEVICES
 actual values 6-7
 Modbus registers B-17
 settings 5-155

DIRECT I/O
 see also DIRECT INPUTS and DIRECT OUTPUTS
 application example 5-156, 5-157
 configuration examples 5-38, 5-42, 5-43
 settings 5-38, 5-42, 5-43, 5-155

DIRECT INPUTS
 actual values 6-7
 application example 5-156, 5-157
 clearing counters 7-2
 Modbus registers B-10, B-17, B-45, B-46, B-47
 settings 5-155
 specifications 2-10

DIRECT OUTPUTS
 application example 5-156, 5-157
 clearing counters 7-2
 Modbus registers B-10, B-45, B-46, B-47
 settings 5-156

DIRECTIONAL OVERCURRENT
 see PHASE, GROUND, and NEUTRAL DIRECTIONAL entries

DIRECTIONAL POLARIZATION 5-105

DISPLAY 1-10, 4-8, 5-8

DISTURBANCE DETECTOR
 FlexLogic™ operands 5-73
 internal 5-48

DNA-1 BIT PAIR	5-154	FAST FORM-C RELAY	2-11
DNP COMMUNICATIONS		FAST TRANSIENT TESTING	2-14
binary counters	E-10	FAX NUMBERS	1-1
binary input points	E-8	FEATURES	2-1
binary output points	E-9	FIRMWARE REVISION	6-21
control relay output blocks	E-9	FIRMWARE UPGRADES	4-2
device profile document	E-1	FLASH MESSAGES	5-8
frozen counters	E-10	FLEX STATE PARAMETERS	
implementation table	E-4	actual values	6-6
Modbus registers	B-17	Modbus registers	B-15, B-31
settings	5-13	settings	5-35
DUPLEX, HALF	B-1	specifications	2-8
<hr/>			
E		FLEXCURVES™	
EGD PROTOCOL		equation	5-100
actual values	6-8	Modbus registers	B-21, B-35
Modbus registers	B-30, B-31	settings	5-62
settings	5-20	specifications	2-8
ELECTROSTATIC DISCHARGE	2-14	table	5-62
ELEMENTS	5-3	FLEXELEMENTS™	
ENERGY METERING		actual values	6-17
actual values	6-15	direction	5-85
Modbus registers	B-13	FlexLogic™ operands	5-71
specifications	2-9	hysteresis	5-85
ENERGY METERING, CLEARING	5-10, 7-2	Modbus registers	B-32, B-34
ENERVISTA UR SETUP		pickup	5-85
creating a site list	4-1	scheme logic	5-84
event recorder	4-2	settings	5-83, 5-84, 5-86
firmware upgrades	4-2	specifications	2-8
installation	1-5	FLEXLOGIC™	
introduction	4-1	editing with enerVista UR Setup	4-1
oscillography	4-2	equation editor	5-82
overview	4-1	evaluation	5-77
requirements	1-5	example	5-69, 5-77
EQUATIONS		example equation	5-130
definite time curve	5-100, 5-122	gate characteristics	5-75
FlexCurve™	5-100	Modbus registers	B-22
I ² t curves	5-100	operands	5-70, 5-71
IAC curves	5-99	operators	5-76
IEC curves	5-98	rules	5-77
IEEE curves	5-97	specifications	2-8
ETHERNET		timers	5-82
actual values	6-6	worksheet	5-79
configuration	1-7	FLEXLOGIC™ EQUATION EDITOR	5-82
Modbus registers	B-10	FLEXLOGIC™ TIMERS	
settings	5-12	Modbus registers	B-22
EVENT CAUSE INDICATORS	4-5	settings	5-82
EVENT RECORDER		FORCE CONTACT INPUTS	5-166
actual values	6-19	FORCE CONTACT OUTPUTS	5-167
clearing	5-10, 7-1	FORCE TRIGGER	6-19
Modbus	B-7	FORM-A RELAY	
Modbus registers	B-15	high impedance circuits	3-11
specifications	2-9	outputs	3-10, 3-11, 3-15
via enerVista software	4-2	specifications	2-11
EVENTS SETTING	5-4	FORM-C RELAY	
EXCEPTION RESPONSES	B-5	outputs	3-10, 3-15
<hr/>			
F		specifications	2-11
F485	1-10	FREQUENCY METERING	
FACEPLATE	3-1	actual values	6-16
FACEPLATE PANELS	4-4, 4-7	Modbus registers	B-13
		settings	5-47
		specifications	2-9
		FREQUENCY TRACKING	5-47, 6-17
		FREQUENCY, NOMINAL	5-47
		FUNCTION SETTING	5-4
		FUNCTIONS	2-3
		FUSE	2-11

G

G.703 3-25, 3-26, 3-27, 3-30
 GE TYPE IAC CURVES 5-99
 GROUND CURRENT METERING 6-13
 GROUND IOC
 FlexLogic™ operands 5-71
 logic 5-117
 Modbus registers B-25
 settings 5-117
 GROUND TIME OVERCURRENT
 see entry for GROUND TOC
 GROUND TOC
 FlexLogic™ operands 5-71
 logic 5-116
 Modbus registers B-24
 settings 5-116
 specifications 2-6
 GROUPED ELEMENTS 5-88
 GSSE 5-152, 5-153, 5-154, 6-5

H

HALF-DUPLEX B-1
 HARMONIC CONTENT 6-16
 HARMONICS
 actual values 6-16
 HARMONICS METERING
 specifications 2-9
 HOTTEST-SPOT TEMPERATURE
 actual values 6-12
 FlexLogic™ operands 5-73
 logic 5-94
 Modbus registers B-25
 settings 5-93
 specifications 2-7
 HTTP PROTOCOL 5-18
 HUMIDITY 2-13

I

I2T CURVES 5-100
 IAC CURVES 5-99
 IEC 60870-5-104 PROTOCOL
 interoperability document D-1
 Modbus registers B-18
 point list D-9
 settings 5-19
 IEC 61850 PROTOCOL
 device ID 5-152
 DNA2 assignments 5-154
 Modbus registers B-36, B-37
 remote device settings 5-152
 remote inputs 5-153
 settings 5-16
 UserSt-1 bit pair 5-154
 IEC CURVES 5-98
 IED 1-2
 IED SETUP 1-5
 IEEE C37.94 COMMUNICATIONS 3-31, 3-32, 3-34
 IEEE CURVES 5-97
 IMPORTANT CONCEPTS 1-4
 IN SERVICE INDICATOR 1-12, 7-4
 INPUTS

AC current 2-10, 5-45
 AC voltage 2-10, 5-46
 contact inputs 2-10, 3-13, 5-146, 5-166
 dcmA inputs 2-10, 3-17
 direct inputs 2-10
 IRIG-B 2-10, 3-21
 remote inputs 2-10, 5-152, 5-153
 RTD inputs 2-10, 3-17
 virtual 5-148
 INSPECTION CHECKLIST 1-1
 INSTALLATION
 communications 3-19
 contact inputs/outputs 3-11, 3-13, 3-14
 CT inputs 3-9
 RS485 3-20
 settings 5-44
 VT inputs 3-8
 INSTANTANEOUS DIFFERENTIAL
 FlexLogic™ operands 5-73
 logic 5-93
 Modbus registers B-26
 settings 5-92
 specifications 2-6
 INSTANTANEOUS OVERCURRENT
 see PHASE, GROUND, and NEUTRAL IOC entries
 INSULATION RESISTANCE 2-14
 INTELLIGENT ELECTRONIC DEVICE 1-2
 INTER-RELAY COMMUNICATIONS 2-13
 INTRODUCTION 1-2
 INVERSE TIME UNDERVOLTAGE 5-122
 IOC
 see PHASE, GROUND, and NEUTRAL IOC entries
 IP ADDRESS 5-12
 IRIG-B
 connection 3-21
 settings 5-22
 specifications 2-10, 2-12
 ISO-9000 REGISTRATION 2-14

K

KEYPAD 1-11, 4-8

L

LAMPTEST 7-2
 LANGUAGE 5-8
 LASER MODULE 3-24
 LATCHING OUTPUTS
 application example 5-150, 5-151
 settings 5-149
 specifications 2-11
 LED INDICATORS 4-5, 4-6, 4-7, 5-31
 LED TEST
 FlexLogic™ operand 5-74
 settings 5-29
 specifications 2-8
 LINK POWER BUDGET 2-13
 LOGIC GATES 5-76
 LOSS OF LIFE
 actual values 6-12
 clearing records 7-2
 FlexLogic™ operands 5-73
 logic 5-95
 Modbus registers B-26

INDEX

settings	5-95
specifications	2-7
LOST PASSWORD	5-7

M

MAINTENANCE COMMANDS	7-2
MANUFACTURING DATE	6-21
MEMORY MAP DATA FORMATS	B-51
MENU HEIRARCHY	1-11, 4-9
MENU NAVIGATION	1-11, 4-8, 4-9
METERING	
conventions	6-9, 6-10
current	2-9
demand	2-9
frequency	2-9
harmonics	2-9
power	2-9
THD	2-9
voltage	2-9
METERING CONVENTIONS	6-10
MODBUS	
data logger	B-6, B-7
event recorder	B-7
exception responses	B-5
execute operation	B-4
flex state parameters	5-35
function code 03/04h	B-3
function code 05h	B-4
function code 06h	B-4
function code 10h	B-5
introduction	B-1
memory map data formats	B-51
obtaining files	B-6
oscillography	B-6
passwords	B-7
read/write settings/actual values	B-3
settings	5-12, 5-22
store multiple settings	B-5
store single setting	B-4
supported function codes	B-3
user map	5-22, B-10, B-21
MODEL INFORMATION	6-21
MODIFICATION FILE NUMBER	6-21
MODULES	
communications	3-19
contact inputs/outputs	3-11, 3-13, 3-14
CT	3-9
CT/VT	3-8, 5-6
direct inputs/outputs	3-24
insertion	3-4
order codes	2-5
ordering	2-5
power supply	3-7
transducer I/O	3-17
VT	3-9
withdrawal	3-4
MONITORING ELEMENTS	5-144
MOUNTING	3-1

N

NAMEPLATE	1-1
NEUTRAL DIRECTIONAL OC	
Modbus registers	B-27

NEUTRAL DIRECTIONAL OVERCURRENT	
FlexLogic™ operands	5-72
logic	5-114
polarization	5-112
settings	5-110
specifications	2-7
NEUTRAL INSTANTANEOUS OVERCURRENT	
see entry for NEUTRAL IOC	
NEUTRAL IOC	
FlexLogic™ operands	5-71
logic	5-109
Modbus registers	B-24
settings	5-109
specifications	2-6
NEUTRAL OVERVOLTAGE	
FlexLogic™ operands	5-71
logic	5-125
Modbus registers	B-30
settings	5-125
specifications	2-7
NEUTRAL TIME OVERCURRENT	
see entry for NEUTRAL TOC	
NEUTRAL TOC	
FlexLogic™ operands	5-72
logic	5-108
Modbus registers	B-24
settings	5-108
specifications	2-6
NON-VOLATILE LATCHES	
FlexLogic™ operands	5-71
Modbus registers	B-35
settings	5-87
specifications	2-8

O

ONE SHOTS	5-76
OPERATING TEMPERATURE	2-13
OPERATING TIMES	2-6
ORDER CODES	2-4, 6-21, 7-2
ORDER CODES, UPDATING	7-2
ORDERING	2-3, 2-4, 2-5
OSCILLATORY TRANSIENT TESTING	2-14
OSCILLOGRAPHY	
actual values	6-19
clearing	5-10, 7-1
Modbus	B-6
Modbus registers	B-15, B-19
settings	5-23
specifications	2-9
via COMTRADE	B-6
via enerVista software	4-2
OUTPUTS	
contact outputs	3-11, 3-13, 5-149
control power	2-12
critical failure relay	2-11
Fast Form-C relay	2-11
Form-A relay	2-11, 3-10, 3-11, 3-15
Form-C relay	2-11, 3-10, 3-15
IRIG-B	2-12
latching outputs	2-11, 5-149
remote outputs	5-154
virtual outputs	5-151
OVERCURRENT CURVE TYPES	5-96
OVERCURRENT CURVES	
definite time	5-100

FlexCurves™ 5-100
 I2T 5-100
 IAC 5-99
 IEC 5-98
 IEEE 5-97
OVERFREQUENCY
 FlexLogic™ operands 5-72
 logic 5-138
 settings 5-138
 specifications 2-7
OVERFRQUENCY
 Modbus registers B-26
OVERVOLTAGE
 auxiliary 2-7, 5-127
 neutral 2-7, 5-125
 phase 2-7, 5-124

P

PANEL CUTOFF 3-1
 PARITY 5-11
 PASSWORD SECURITY 5-7
PASSWORDS
 changing 4-12
 lost password 4-12, 5-7
 Modbus B-7
 Modbus registers B-14, B-17
 overview 1-12
 security 5-7
 settings 5-7
PC SOFTWARE
 see entry for ENERVISTA UR SETUP
PERCENT DIFFERENTIAL
 calculations 5-89
 characteristic 5-90
 FlexLogic™ operands 5-74
 logic 5-92
 Modbus registers B-26
 settings 5-89, 5-90
 specifications 2-6
PERMISSIVE FUNCTIONS 5-122
PER-UNIT QUANTITY 5-4
PHASE ANGLE METERING 6-10
PHASE COMPENSATION 5-57
PHASE CURRENT METERING 6-13
PHASE DIRECTIONAL OC
 Modbus registers B-27
PHASE DIRECTIONAL OVERCURRENT
 FlexLogic™ operands 5-72
 logic 5-106
 phase A polarization 5-104
 settings 5-104, 5-105
 specifications 2-6
PHASE INSTANTANEOUS OVERCURRENT
 see entry for PHASE IOC
PHASE IOC
 FlexLogic™ operands 5-72
 logic 5-103
 Modbus registers B-23
 specifications 2-6
PHASE OVERVOLTAGE
 FlexLogic™ operands 5-72
 logic 5-124
 Modbus registers B-27
 settings 5-124
 specifications 2-7

PHASE ROTATION 5-47
PHASE TIME OVERCURRENT
 see entry for PHASE TOC
PHASE TOC
 FlexLogic™ operands 5-72
 logic 5-102
 Modbus registers B-23
 settings 5-101
 specifications 2-6
PHASE UNDERVOLTAGE
 FlexLogic™ operands 5-72
 logic 5-123
 Modbus registers B-27
 settings 5-123
 specifications 2-7
PHONE NUMBERS 1-1
POWER METERING
 Modbus registers B-12
 specifications 2-9
 values 6-14
POWER SUPPLY
 description 3-7
 low range 2-11
 specifications 2-11
POWER SYSTEM
 Modbus registers B-21
PREFERENCES
 Modbus registers B-17
PRODUCT INFORMATION 6-21, B-8
PRODUCT SETUP 5-7
PRODUCTION TESTS 2-14
PROTECTION ELEMENTS 5-3
PU QUANTITY 5-4
PUSHBUTTONS, USER-PROGRAMMABLE
 see USER-PROGRAMMABLE PUSHBUTTONS

R

REACTIVE POWER 2-9, 6-14
REAL POWER 2-9, 6-14
REAL TIME CLOCK
 Modbus registers B-19
 settings 5-22
REAR TERMINAL ASSIGNMENTS 3-5
RECLOSER CURVES 5-65, 5-100
REDUNDANT 10BASE-F 3-18
RELAY ACTIVATION 4-11
RELAY ARCHITECTURE 5-69
RELAY MAINTENANCE 7-2
RELAY NAME 5-44
RELAY NOT PROGRAMMED 1-12
REMOTE DEVICES
 actual values 6-5
 device ID 5-152
 FlexLogic™ operands 5-74
 Modbus registers B-10, B-15, B-47
 settings 5-152
 statistics 6-5
REMOTE INPUTS
 actual values 6-3
 FlexLogic™ operands 5-74
 Modbus registers B-10, B-15, B-48
 settings 5-153
 specifications 2-10
REMOTE OUTPUTS
 DNA-1 bit pair 5-154

INDEX

Modbus registers	B-49, B-50	SNTP PROTOCOL	
UserSt-1 bit pair	5-154	Modbus registers	B-18
REPLACEMENT MODULES	2-5	settings	5-20
RESETTING	5-74, 5-155	SOFTWARE	
RESTRICTED GROUND FAULT		installation	1-5
actual values	6-18	see entry for ENERVISTA UR SETUP	
FlexLogic™ operands	5-73	SOFTWARE ARCHITECTURE	1-4
Modbus registers	B-11, B-50	SOFTWARE, PC	
settings	5-118	see entry for enerVista UR Setup	
specifications	2-6	SOURCE FREQUENCY	6-16
REVISION HISTORY	F-1	SOURCE TRANSFER SCHEMES	5-122
RFI SUSCEPTIBILITY	2-14	SOURCES	
RFI, CONDUCTED	2-14	description	5-5
RMS CURRENT	2-9	example use of	5-49
RMS VOLTAGE	2-9	metering	6-13
ROLLING DEMAND	5-28	Modbus registers	B-20
RS232		settings	5-48
configuration	1-8	SPECIFICATIONS	2-6
specifications	2-12	ST TYPE CONNECTORS	3-20
wiring	3-18	STANDARD ABBREVIATIONS	F-4
RS422		STATUS INDICATORS	4-5
configuration	3-28	SURGE IMMUNITY	2-14
timing	3-29	SYMMETRICAL COMPONENTS METERING	6-10
two-channel application	3-28	SYSTEM FREQUENCY	5-47
with fiber interface	3-30	SYSTEM SETUP	5-45
RS485			
communications	3-18		
description	3-20		
specifications	2-12		
RTD INPUTS			
actual values	6-18		
Modbus registers	B-16, B-28		
settings	5-162		
specifications	2-10		
<hr/>			
S		T	
SALES OFFICE	1-1	TARGET MESSAGES	7-4
SCAN OPERATION	1-4	TARGET SETTING	5-4
SELECTOR SWITCH		TARGETS MENU	7-4
actual values	6-6	TCP PORT NUMBER	5-18
application example	5-136	TELEPROTECTION	
FlexLogic™ operands	5-73	actual values	6-4
logic	5-136	clearing counters	7-2
Modbus registers	B-34, B-35	FlexLogic™ operands	5-73
settings	5-131	logic	5-160
specifications	2-8	Modbus registers	B-34
timing	5-134, 5-135	overview	5-159
SELF-TESTS		settings	5-43, 5-159, 5-160
description	7-4	specifications	2-10
error messages	7-5	TEMPERATURE, OPERATING	2-13
FlexLogic™ operands	5-75	TERMINALS	3-5
Modbus registers	B-8	TESTING	
SERIAL NUMBER	6-21	force contact inputs	5-166
SERIAL PORTS		force contact outputs	5-167
Modbus registers	B-17	lamp test	7-2
settings	5-11	self-test error messages	7-4
SETTING GROUPS	5-73, 5-88, 5-130, B-25	THD	
SETTINGS, CHANGING	4-10	Modbus registers	B-14
SIGNAL SOURCES		THD METERING	2-9, 6-16
description	5-5	analog channel correspondence	5-25
metering	6-13	THERMAL DEMAND CHARACTERISTIC	5-28
settings	5-48	THERMAL INPUTS	
SIGNAL TYPES	1-3	Modbus registers	B-26
SINGLE LINE DIAGRAM	2-1, 2-2	settings	5-61
SITE LIST, CREATING	4-1	TIME	7-2
		TIME OVERCURRENT	
		see PHASE, NEUTRAL, and GROUND TOC entries	
		TIMERS	5-82
		TOC	
		ground	5-116
		neutral	5-108
		phase	5-101
		specifications	2-6
		TRACKING FREQUENCY	6-17, B-30

TRANSDUCER I/O
 actual values 6-18
 settings 5-161, 5-162
 specifications 2-10
 wiring 3-17

TRANSFORMER
 actual values 6-12
 aging factor 2-7, 5-94
 hottest-spot temperature 2-7, 5-93
 loss of life 2-7, 5-95
 metering 6-12
 Modbus registers B-21
 phase relationships 5-53
 phasors 5-54
 settings 5-50, 5-52, 5-61
 thermal inputs 5-61

TRANSFORMER DIFFERENTIAL 5-50, 5-52, 5-59, 5-88
 Modbus registers B-14

TRIP LEDs 5-31

TROUBLE INDICATOR 1-12, 7-4

TYPE TESTS 2-14

TYPICAL WIRING DIAGRAM 3-6

U

UL APPROVAL 2-14

UNAUTHORIZED ACCESS
 commands 5-10
 resetting 7-2

UNDERFREQUENCY
 FlexLogic™ operands 5-73
 logic 5-137
 Modbus registers B-29
 settings 5-137
 specifications 2-7

UNDERVOLTAGE
 auxiliary 2-7
 phase 2-7, 5-123

UNDERVOLTAGE CHARACTERISTICS 5-122

UNIT NOT PROGRAMMED 5-44

UNPACKING THE RELAY 1-1

UNRETURNED MESSAGES ALARM 5-43

UPDATING ORDER CODE 7-2

URPC
 see entry for ENERVISTA UR SETUP

USER-DEFINABLE DISPLAYS
 example 5-37
 invoking and scrolling 5-36
 Modbus registers B-17, B-21
 settings 5-36, 5-37
 specifications 2-8

USER-PROGRAMMABLE FAULT REPORT
 actual values 6-19
 clearing 5-10, 7-1
 Modbus registers B-15
 settings 5-22

USER-PROGRAMMABLE LEDs
 custom labeling 4-7
 description 4-6
 Modbus registers B-19
 settings 5-31
 specifications 2-8

USER-PROGRAMMABLE PUSHBUTTONS

FlexLogic™ operands 5-75

Modbus registers B-22

settings 5-34

specifications 2-8

USER-PROGRAMMABLE SELF TESTS
 Modbus registers B-20
 settings 5-32

USERST-1 BIT PAIR 5-154

V

VAR-HOURS 2-9, 6-15

VIBRATION TESTING 2-14

VIRTUAL INPUTS
 actual values 6-3
 commands 7-1
 FlexLogic™ operands 5-74
 logic 5-148
 Modbus registers B-8, B-40
 settings 5-148

VIRTUAL OUTPUTS
 actual values 6-4
 FlexLogic™ operands 5-74
 Modbus registers B-42
 settings 5-151

VOLTAGE BANKS 5-46

VOLTAGE DEVIATIONS 2-14

VOLTAGE ELEMENTS 5-122

VOLTAGE METERING
 Modbus registers B-11
 specifications 2-9
 values 6-13

VOLTAGE RESTRAINT CHARACTERISTIC 5-101

VOLTS PER HERTZ
 actual values 6-17, 6-18
 curves 5-129
 FlexLogic™ operands 5-73
 logic 5-128
 Modbus registers B-35
 settings 5-128
 specifications 2-7

VT INPUTS 3-9, 5-6, 5-46

VT WIRING 3-9

W

WARRANTY F-6

WATT-HOURS 2-9, 6-15

WEB SERVER PROTOCOL 5-18

WEBSITE 1-1

WINDING
 application example 5-59

WINDINGS
 Modbus registers B-21

WIRING DIAGRAM 3-6

Z

ZERO SEQUENCE CORE BALANCE 3-9

ZERO-SEQUENCE COMPENSATION 5-57